

DOT/FAA/CT-96/1

FAA Technical Center  
Atlantic City International Airport, NJ 08405

# HUMAN FACTORS DESIGN GUIDE

For Acquisition of Commercial-Off-The-Shelf Subsystems,  
Non-Developmental Items, and  
Developmental Systems

Dan Wagner, ACT-530

Joseph A. Birt  
Michael Snyder  
System Resources Corporation (SRC)

James P. Duncanson  
CTA INCORPORATED

January 15, 1996

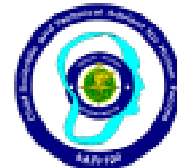
Final Report and Guide

This document is available to the public through the  
National Technical Information Service,  
Springfield, Virginia 22161



US Department  
of Transportation

Federal Aviation  
Administration



Office of the Chief Scientific  
and Technical Advisor for  
Human Factors  
AAR 100

### **Notice**

**This document is disseminated under the sponsorship of the U.S. Department of Transportation in the interest of information exchange. The United States Government assumes no liability for the contents or used thereof.**

**The United States Government does not endorse products or manufacturers. Trade or manufacturers' names appear herein solely because they are considered essential to the objective of this report.**

<b>1. Report No.</b> DOT/FAA/CT-96/1		<b>2. Government Accession No.</b>		<b>3. Recipient's Catalog No.</b>	
<b>4. Title and Subtitle</b> HUMAN FACTORS DESIGN GUIDE (HFDG) For Acquisition of Commercial Off-The-Shelf Subsystems, Non-Developmental Items, and Developmental Systems			<b>5. Report Date</b> January 15, 1996		
			<b>6. Performing Organization Code</b> ACT-500		
<b>7. Author(s)</b> Dan Wagner (ACT-530), Joseph A. Birt and Michael D. Snyder (SRC), and James P. Duncanson (CTA)			<b>8. Performing Organization Report No.</b> DOT/FAA/CT-96/1		
<b>9. Performing Organization Name and Address</b> U.S. Department of Transportation Federal Aviation Administration Technical Center Atlantic City International Airport, NJ 08405			<b>10. Work Unit No (TRAILS)</b>		
			<b>11. Contract or Grant No.</b> F2203C		
<b>12. Sponsoring Agency Name and Address</b> U.S. Department of Transportation Federal Aviation Administration Headquarters Program Management & Planning Division 800 Independence Avenue, SW Washington, DC 20591			<b>13. Type of Report and Period Covered</b> Technical Report		
			<b>14. Sponsoring Agency Code</b> ALM-100		
<b>15. Supplementary Notes:</b> This work was accomplished under the direction of Dan Wagner, ACT-530, as part of the FAA's Airway Facilities Human Factors R,E & D Program. The Program is sponsored by Brenda Boone, ALM-100, and managed by Lawrence Cole, AAR-100. Technical consultation was provided by Kermit Grayson.					
<b>16. Abstract</b> The Human Factors Design Guide (HFDG) provides reference information to assist in the selection, analysis, design, development, and evaluation of new and modified Federal Aviation Administration (FAA) systems and equipment. A preliminary edition was a draft standard developed at the Human Factors Laboratory of the FAA Technical Center. This 1996 edition converts the preliminary draft document to a guide and incorporates expert comments that were collected in 1994 and 1995 from selected reviewers. It is primarily focused on FAA ground systems and equipment such as those that are managed and maintained by Airway Facilities. This guide covers a broad range of human factors topics that pertain to automation, maintenance, human interfaces, workplace design, documentation, system security, safety, the environment, and anthropometry. This document also includes extensive human-computer interface guidance.					
<b>17. Key Words</b>  Human factors, Human-equipment interfaces, Human-computer interfaces, maintenance automation, design for maintenance, workplace design, user documentation, system security, personnel safety, environment			<b>18. Distribution Statement</b>  This document is available to the public through the National Technical Information Service, Springfield, VA 22161		
<b>19. Security Classif. (of this report)</b> Unclassified		<b>20. Security Classif. (of this page)</b> Unclassified		<b>21. No of pages</b> 1012	<b>22. Price</b>

# Foreword

The *Human Factors Design Guide (HFDG) for Acquisition of Commercial-off-the-Shelf (COTS) Subsystems, Non-Developmental Items (NDI), and Developmental Systems* is a comprehensive reference tool that will help human factors professionals within the Federal Aviation Administration (FAA) and contractor organizations to efficiently carry out FAA human factors policy.

A preliminary edition of the present document was a draft standard developed at the Human Factors Laboratory of the FAA Technical Center. This 1996 edition converts the preliminary draft document to a guide and incorporates expert comments that were collected in 1994 from selected reviewers.

FAA Order 9550.8, *Human Factors Policy*, states that:

Human factors shall be systematically integrated into the planning and execution functions of all FAA elements and activities associated with system acquisition and system operations. FAA endeavors shall emphasize human factors considerations to enhance system performance and capitalize upon the relative strengths of people and machines. . .

The *Acquisition Strategy Paper* required by the new FAA *Acquisition Management System*, April, 1997, states that:

. . . human factors will be considered during architectural and engineering design to achieve effective human performance during operations, maintenance, and support.

The HFDG was developed by the Aviation Simulation and Human Factors Division at the FAA Technical Center to consolidate and capitalize upon multiple sources of human factors design and evaluation guidelines. It provides FAA system modernization programs access to the most applicable human factors guidance. This guide is intended to overcome the imitations associated with using other design standards in an FAA environment.

Application of this design guide is not a substitute for in-depth professional human factors practice. The Acquisition Management System also refers to a military human factors process standard, MIL-STD-46855, which calls for planning human factors activities and procedures. Both human factors acquisition guidelines and processes are to be professionally applied. The use of the HFDG requires expert professional judgment on its application to new systems and equipment.

This document compiles extensive guidance from diverse and exhaustive sources for human factors applications integral to the procurement, acquisition, design, development, and testing of FAA systems, facilities, and equipment. It will aid in identifying

functional, product, and NAS specification requirements and in ensuring acceptable human factors practice and products.

This edition of the HFDG is applicable to COTS and NDI procurements as well as new developmental system or equipment acquisitions. The relationship between hardware and software subsystems and the human subsystem's characteristics must be determined and tested in advance of commitments to procure and implement COTS and NDI equipment and systems. These characteristics can include human roles, organizations, interfaces, tasks, training, and human performance effectiveness.

This version of the HFDG remains primarily focused upon FAA ground systems and equipment such as those that are managed and maintained by Airway Facilities. Although good human factors practices and principles apply to all FAA systems, this guide is not directed at special considerations in Air Traffic Control operations, aircraft maintenance, aircraft or airborne equipment certification, or FAA's regulatory certification for aviation personnel, although many of the HFDG provisions apply to those environments. Future editions will more directly address these areas of NAS development and operations.

The HFDG draws heavily from human factors information published by the Department of Defense, National Aeronautics and Space Administration, and Department of Energy. The FAA recognizes the excellent quality of information found in many of the technical documents and handbooks written by these agencies.

**Request for feedback comments.** Comments for corrections or improvements are welcome. Comments can be made at any time by using the form at the end of the document.

# Contents

<b>Foreword</b>	.....	<b>i</b>
<b>Contents</b>	.....	<b>iii</b>
<b>List of exhibits</b>	.....	<b>vii</b>
<b>1 Introduction</b>	.....	<b>1-1</b>
1.1 Purpose	.....	1-1
1.2 Objectives	.....	1-1
1.3 Scope	.....	1-1
1.4 Format	.....	1-3
<b>2 Complementary documents</b>	.....	<b>2-1</b>
2.1 Government documents	.....	2-1
2.2 Nongovernment documents	.....	2-6
<b>3 Definitions</b>	.....	<b>3-1</b>
<b>4 General design requirements</b>	.....	<b>4-1</b>
4.1 Principles for designing systems and equipment	.....	4-1
4.2 Human performance	.....	4-2
4.3 System interactions	.....	4-4
<b>5 Maintenance automation</b>	.....	<b>5-1</b>
5.1 General goals and principles	.....	5-1
5.2 Human-centered automation	.....	5-3
5.3 Process control lessons	.....	5-9
5.4 Command, control, and communications	.....	5-13
5.5 System engineering	.....	5-17
5.6 Human interfaces for maintenance automation	.....	5-18
5.7 Monitoring	.....	5-19
5.8 Control of remote maintenance	.....	5-24
5.9 Maintenance management information	.....	5-25
5.10 Additional technical and maintenance information considerations	.....	5-28
<b>6 Designing equipment for maintenance</b>	.....	<b>6-1</b>
6.1 General	.....	6-1
6.2 Designing equipment for handling	.....	6-5
6.3 Packaging, arrangement, and mounting of equipment	.....	6-13
6.4 Access openings	.....	6-23
6.5 Covers, guards, and shields	.....	6-28
6.6 Cases	.....	6-34
6.7 Fasteners	.....	6-38
6.8 Connectors	.....	6-47
6.9 Lines and cables	.....	6-56

6.10	Packaging, layout, and mounting of internal components.....	6-71
6.11	Adjustment controls .....	6-80
6.12	Failure detection and isolation .....	6-81
6.13	Fuses and circuit breakers .....	6-83
6.14	Test points and service points .....	6-89
6.15	Test equipment .....	6-93
6.16	Tools.....	6-100
<b>7</b>	<b>Human-equipment interfaces.....</b>	<b>7-1</b>
7.1	Display-control integration.....	7-1
7.2	Visual displays .....	7-6
7.3	Audio displays.....	7-42
7.4	Controls .....	7-53
7.5	Labeling and marking.....	7-96
7.6	Accommodating people with disabilities .....	7-101
<b>8</b>	<b>Human-computer interfaces.....</b>	<b>8-1</b>
8.1	User-computer interaction.....	8-1
8.2	Basic screen design and operation.....	8-40
8.3	Windowing .....	8-54
8.4	Data entry .....	8-85
8.5	Data display.....	8-101
8.6	User guidance .....	8-125
8.7	Data communication .....	8-130
8.8	Input devices.....	8-136
8.9	Accommodating people with disabilities .....	8-149
<b>9</b>	<b>Workplace design .....</b>	<b>9-1</b>
9.1	General .....	9-1
9.2	Workplace layout .....	9-3
9.3	Design of passageways.....	9-8
9.4	Common working positions .....	9-31
9.5	Standard console design .....	9-43
9.6	Visual display terminals .....	9-52
9.7	Accommodating people with disabilities: accessible elements and space .....	9-53
<b>10</b>	<b>User documentation .....</b>	<b>10-1</b>
10.1	General .....	10-1
10.2	Writing user documentation .....	10-3
10.3	Layout and formatting .....	10-19
10.4	Components of documents .....	10-31
10.5	Specific user document contents .....	10-48
10.6	Accommodating people with disabilities .....	10-66
<b>11</b>	<b>System security.....</b>	<b>11-1</b>
11.1	General design practice .....	11-1
11.2	Physical security and access control.....	11-3
11.3	Identification and authentication .....	11-4
11.4	Auditing.....	11-9

11.5	Information and data protection .....	11-9
11.6	Documentation of security safeguards .....	11-11
11.7	Security training .....	11-11
<b>12</b>	<b>Personnel safety .....</b>	<b>12-1</b>
12.1	General .....	12-1
12.2	Work space safety.....	12-1
12.3	Equipment-related safety.....	12-4
12.4	Electrical hazards .....	12-5
12.5	Physical hazards .....	12-13
12.6	Liquid and gas hazards.....	12-16
12.7	Toxic hazards .....	12-16
12.8	Radiation hazards .....	12-18
12.9	Protection from special chemicals.....	12-18
12.10	Temperature hazards .....	12-19
12.11	Fire protection .....	12-20
12.12	Noise hazards .....	12-21
12.13	Explosion and implosion hazards.....	12-23
12.14	Radiant energy hazards.....	12-24
12.15	Laser hazards.....	12-28
12.16	Safety labels and placards .....	12-29
<b>13</b>	<b>Environment .....</b>	<b>13-1</b>
13.1	General guidelines.....	13-1
13.2	Ventilation.....	13-2
13.3	Temperature and humidity .....	13-3
13.4	Illumination .....	13-7
13.5	Noise.....	13-14
<b>14</b>	<b>Anthropometry and biomechanics .....</b>	<b>14-1</b>
14.1	General application of anthropometric and biomechanical data .....	14-1
14.2	Anthropometric variability factors .....	14-15
14.3	Anthropometric and biomechanical data.....	14-16
14.4	Reach.....	14-36
14.5	Human strength and handling capacity .....	14-42
14.6	Design for physical comfort.....	14-52
<b>Appendixes</b>		
Appendix A	References .....	A-1
Appendix B	Sources .....	B-1
Appendix C	"Standard" actions for push buttons .....	C-1
Appendix D	"Standard" verbs.....	D-1
<b>Index</b>	.....	<b>I-1</b>
<b>Comment forms (3)</b> .....		after index





# List of Exhibits

## 1 Introduction

Exhibit 1.4.2.4	Navigating within the page format .....	1-5
-----------------	---	-----

## 2 Complementary documents (This section has no exhibits)

## 3 Definitions (This section has no exhibits)

## 4 General design requirements (This section has no exhibits)

## 5 Maintenance automation (This section has no exhibits)

## 6 Designing equipment for maintenance

Exhibit 6.2.2.1	Maximum weight limits for objects lifted by one person using both hands for a combined male and female population .....	6-6
Exhibit 6.2.5.1.5	Maximum force limits for pulling and pushing units of equipment using handles or grasp areas .....	6-9
Exhibit 6.2.5.3.1	Minimum handle dimensions .....	6-10
Exhibit 6.2.5.3.2	Minimum handle diameter required by weight of unit of equipment .....	6-11
Exhibit 6.3.5.3.1	Minimum character height for various viewing distances .....	6-21
Exhibit 6.3.5.5.2	Recommended colors .....	6-22
Exhibit 6.3.5.5.3	Good and bad arrows .....	6-23
Exhibit 6.4.3.2	Minimum dimensions of openings designed for access by one or two fingers without visual access .....	6-24
Exhibit 6.4.3.3	Minimum dimensions of openings designed for access by one hand or arm without visual access .....	6-25
Exhibit 6.4.3.4	Minimum dimensions of openings designed for access by two hands without visual access .....	6-26
Exhibit 6.5.7.2	Type of covering appropriate for type of access and environmental conditions .....	6-31
Exhibit 6.7.3.3.2	Examples of combination head bolts and screws .....	6-42
Exhibit 6.7.3.3.4	Example of an internal-wrenching bolt and nut .....	6-43
Exhibit 6.8.2.4	Example of a quick-action connector .....	6-49
Exhibit 6.8.5.2.3	Fanning out cables .....	6-53
Exhibit 6.8.5.2.4	Example of a crimp-on splice .....	6-53
Exhibit 6.8.5.2.7	Examples of a U-lug and an O-lug .....	6-53
Exhibit 6.9.1.1.13	Cable winders .....	6-58
Exhibit 6.9.1.2.6	Recoiling slack cable .....	6-60

Exhibit 6.9.1.5.3	Quick-release clamps, hinged and spring .....	6-62
Exhibit 6.9.1.6.6	Line and cable reel carts .....	6-63
Exhibit 6.9.1.6.8	Line and cable mobile support .....	6-64
Exhibit 6.9.1.8.4	Electrical cable coding .....	6-65
Exhibit 6.9.1.8.7	Values for color-coded fixed resistors and small capacitors .....	6-66
Exhibit 6.9.2.1.3	Externally visible seals .....	6-66
Exhibit 6.9.2.4.1	Color coding of fluid conductors .....	6-69
Exhibit 6.9.2.4.2	Valve color coding scheme .....	6-69
Exhibit 6.9.2.4.3	Hydraulic and pneumatic line coding .....	6-70
Exhibit 6.9.2.4.5	Valve position labeling .....	6-70
Exhibit 6.10.4.1	Example of fold-out mounting construction .....	6-76
Exhibit 6.10.4.7	Error-free mounting provisions .....	6-77
Exhibit 6.13.1.1	General comparison of fuses and circuit breakers .....	6-84
Exhibit 6.13.3.1	Push-pull circuit breaker specifications .....	6-86
Exhibit 6.13.4.1	Toggle bat specifications .....	6-87
Exhibit 6.13.4.2	Legend switch specifications .....	6-88
Exhibit 6.14.2.13	Terminal strips .....	6-90
Exhibit 6.14.4.4 (a)	Test plug with sliding cover .....	6-92
Exhibit 6.14.4.4 (b)	Test point adapter .....	6-92

## 7 Human-equipment interfaces

Exhibit 7.2.1.6.3	Lines of sight .....	7-11
Exhibit 7.2.1.6.8	Optimum vertical and horizontal visual fields .....	7-12
Exhibit 7.2.2.1.20	Color coding of transilluminated displays .....	7-16
Exhibit 7.2.2.3.3	Coding of simple indicator lights .....	7-17
Exhibit 7.2.3.1	Characteristics and ratings of fixed and moveable pointer scales for various uses .....	7-19
Exhibit 7.2.4.6.2	Minimum alphanumeric character height; as a fraction of viewing distance and, at a viewing distance of 457 mm (18 in) .....	7-26
Exhibit 7.2.8.1.3	Stroke width for pixel-generated characters .....	7-33
Exhibit 7.2.8.1.4	Height-width relationship for pixel-generated characters .....	7-34
Exhibit 7.2.9	Characteristics and ratings of counters, printers, and flags for various uses .....	7-38
Exhibit 7.3.1.3	Characteristics and ratings of audio signals for various uses .....	7-43
Exhibit 7.3.5.6.2	Speech intelligibility criteria for various communication requirements and evaluation methods .....	7-53
Exhibit 7.4.1.1.5 (a)	Characteristics of common controls for discrete adjustment .....	7-54
Exhibit 7.4.1.1.5 (b)	Characteristics of common controls for continuous adjustment .....	7-55
Exhibit 7.4.1.1.6	Advantages and disadvantages of common controls .....	7-56
Exhibit 7.4.1.3.7	Minimum spacing between controls .....	7-59
Exhibit 7.4.1.4.1	Advantages and disadvantages of different types of coding .....	7-60
Exhibit 7.4.3.1	Foot-operated switch specifications .....	7-64

Exhibit 7.4.4.1.1	Rotary selector switch specifications .....	7-66
Exhibit 7.4.4.2.1	Key-operated switch specifications .....	7-67
Exhibit 7.4.4.3.8	Discrete thumbwheel specifications .....	7-69
Exhibit 7.4.4.4.1	Knob specifications .....	7-71
Exhibit 7.4.4.5.1	Ganged control knob specifications .....	7-72
Exhibit 7.4.4.5.5	Relationship between ganged knobs and their associated displays .....	7-73
Exhibit 7.4.4.6.1	Continuous thumbwheel specifications .....	7-74
Exhibit 7.4.4.7.1	Crank specifications .....	7-76
Exhibit 7.4.4.8.1	Push button specifications .....	7-77
Exhibit 7.4.4.10.1	Toggle switch specifications .....	7-80
Exhibit 7.4.4.11.1	Legend switch specifications .....	7-81
Exhibit 7.4.4.12.1	Rocker switch specifications .....	7-83
Exhibit 7.4.4.13.1	Slide switch specifications .....	7-84
Exhibit 7.4.4.14.1	Push-pull control specifications .....	7-86
Exhibit 7.4.4.16.1	Lever specifications .....	7-88
Exhibit 7.4.4.18.1	Finger-operated displacement joystick specifications .....	7-91
Exhibit 7.4.4.22.1	Ball control specifications .....	7-93
Exhibit 7.4.4.24.1	High-force hand control specifications .....	7-95
Exhibit 7.5.3.1	Minimum character height for various viewing distances under normal luminance levels .....	7-99
Exhibit 7.6.3.2	Maximum force requirements for people with arthritis or muscular dystrophy .....	7-110

## 8 Human-computer interfaces

Exhibit 8.1.2.2	Maximum system response times for routine system tasks .....	8-5
Exhibit 8.1.8.1	Appropriateness of interaction types for various task requirements, system characteristics, and user abilities .....	8-17
Exhibit 8.1.15.2.7	Example of a default push button .....	8-38
Exhibit 8.1.15.3.1	Two types of radio button sets .....	8-39
Exhibit 8.2.4.1.4	Discriminable colors and their wavelengths .....	8-51
Exhibit 8.2.4.1.20	Luminance contrast ratios for various conditions .....	8-53
Exhibit 8.3.7.2.9	Example of mnemonics and accelerators .....	8-66
Exhibit 8.3.10.1.11	Example of a control window .....	8-75
Exhibit 8.4.6.1.2	Examples of better and worse graphics cursors .....	8-99
Exhibit 8.5.5.4.4	Examples of acceptable and unacceptable patterns .....	8-111
Exhibit 8.5.5.4.5	Example of axes with breaks .....	8-111
Exhibit 8.8	Advantages and disadvantages of non-keyboard input devices .....	8-136
Exhibit 8.8.1.5	Cursor movement keys .....	8-139
Exhibit 8.8.3.2.5	Dimensions of a mouse .....	8-142
Exhibit 8.8.3.6.1	Pointer shapes associated with functions .....	8-145
Exhibit 8.8.4.2.5	Touch panel responsive area dimensions .....	8-148

## 9 Workplace design

Exhibit 9.2.2.1.2	Access space through integral design .....	9-6
Exhibit 9.3.1.1	Walkway and passageway dimensions .....	9-9
Exhibit 9.3.4.2.1	Door dimensions .....	9-14

Exhibit 9.3.4.6.1	Whole body access dimensions .....	9-18
Exhibit 9.3.5.1.1	Selection .....	9-19
Exhibit 9.3.5.3.1	Critical dimensions for ramps .....	9-22
Exhibit 9.3.5.3.3	Combined ramp and stairs .....	9-22
Exhibit 9.3.5.4.1	Design requirements for stairs dimensions .....	9-24
Exhibit 9.3.5.5.1	Design requirements for stair ladder dimensions .....	9-25
Exhibit 9.3.5.6.1	Design requirements for fixed ladders .....	9-27
Exhibit 9.3.5.6.2	Design requirements for fixed ladder cage dimensions .....	9-28
Exhibit 9.3.5.7.1 (a)	Design requirements for portable step ladders .....	9-29
Exhibit 9.3.5.7.1 (b)	Design requirements for portable rung ladders .....	9-30
Exhibit 9.4.1	Anthropometric data for common working positions .....	9-32
Exhibit 9.4.2.2	Mobile work space dimensions and illustrations .....	9-37
Exhibit 9.4.3.1	Standing workplace illustration and dimensions .....	9-39
Exhibit 9.4.4.4	Seated workplace dimensions and illustrations .....	9-41
Exhibit 9.4.4.10	Swing-away seat for short term use .....	9-43
Exhibit 9.5.1.1 (a)	Standard console dimensions .....	9-44
Exhibit 9.5.1.1 (b)	Standard console illustration and dimensions key .....	9-45
Exhibit 9.5.2	Example of horizontal wrap-around console .....	9-46
Exhibit 9.5.3	Example of vertical stacked segments .....	9-47
Exhibit 9.5.4.1	Basic and variations of multiperson console arrangements with an example control room arrangement .....	9-48
Exhibit 9.5.4.2	Concepts of functional reach arc and equidistant visual arc for a stand console .....	9-50
Exhibit 9.5.4.4	Recommended placement areas for controls and displays on vertical and stand consoles .....	9-52

## 10 User documentation

Exhibit 10.3.2.1.3	Margin sizes for standard paper sizes .....	10-21
Exhibit 10.4	FAA directives and order of document components .....	10-32
Exhibit 10.4.1.2	Type sizes for cover page elements .....	10-34
Exhibit 10.4.12.3 (a)	User feedback form -- Front .....	10-46
Exhibit 10.4.12.3 (b)	User feedback form -- Back .....	10-47

## 11 System security

(This section has no exhibits)

## 12 Personnel safety

Exhibit 12.2.1.8	Specific task illumination requirements .....	12-3
Exhibit 12.4	Shock current intensities and their effects .....	12-6
Exhibit 12.4.1.3	Proof test values for protective gloves .....	12-7
Exhibit 12.4.1.9	An interlock switch .....	12-8

Exhibit 12.4.3.3	Automatic shorting bar .....	12-10
Exhibit 12.4.4.6	Equipment grounding .....	12-12
Exhibit 12.5.1.4 (a)	Rolling edges of sheets less than 0.5 mm (0.02 in) thick .....	12-13
Exhibit 12.5.1.4 (b)	Rounding exposed edges 0.5 up to 3.0 mm (0.02 up to 0.12 in ) thick .....	12-14
Exhibit 12.5.1.4 (c)	Rounding exposed edges 3.0 up to 6.4 mm (0.12 up to 0.25 in) thick .....	12-14
Exhibit 12.5.1.4 (d)	Rounding of exposed edges 6.4 mm (0.25 in) thick or greater .....	12-14
Exhibit 12.5.1.5 (a)	Requirements for rounding of corners less than 25 mm (1.0 in) thick .....	12-14
Exhibit 12.5.1.5 (b)	Requirements for rounding of corners greater than 25 mm (1.0 in) thick .....	12-15
Exhibit 12.10.1	Upper and lower temperature limit ranges .....	12-20
Exhibit 12.12.8	Permissible noise exposure .....	12-23
Exhibit 12.14.1.1	Exposure limit for ultraviolet radiant energy (200 to 315 nm) .....	12-25
Exhibit 12.14.3	Relative contribution of different wavelengths to luminance -- the luminosity function .....	12-26
Exhibit 12.14.3.1	Maximum safe exposure to 400-1400 nm radiant energy .....	12-26
Exhibit 12.14.3.4	Estimation of permissible image luminance .....	12-27
Exhibit 12.16.2	Label and placard layout--two panel sign with optional symbol panel .....	12-30

## 13 Environment

Exhibit 13.2.3	Large enclosure ventilation .....	13-2
Exhibit 13.3	Comfort zone chart .....	13-4
Exhibit 13.3.1	Deriving effective temperature .....	13-5
Exhibit 13.4.2.2	Specific task illumination requirements .....	13-9
Exhibit 13.4.6.3	Required brightness ratios .....	13-13
Exhibit 13.5.1.1	Permissible exposure limits .....	13-15

## 14 Anthropometry and biomechanics

Exhibit 14.1.4.7	Additive effects of clothing on anthropometric measures .....	14-11
Exhibit 14.1.5.1	Percentile values .....	14-13
Exhibit 14.3.2.1	Static human physical characteristics (head) .....	14-18
Exhibit 14.3.2.1	Static human physical characteristics (seated) .....	14-22
Exhibit 14.3.2.1	Static human physical characteristics (standing) .....	14-26
Exhibit 14.3.2.1	Static human physical characteristics (hands) .....	14-29
Exhibit 14.3.2.1	Static human physical characteristics (standing position) .....	14-30
Exhibit 14.3.3.2.1	Joint movement ranges .....	14-32
Exhibit 14.3.3.2.2	Change in range of joint movement with movement in an adjacent joint .....	14-35

---

Exhibit 14.4.2	Reach envelopes in vertical and horizontal planes .....	14-37
Exhibit 14.4.4 (a)	Touch, grip, and grasp functions that interact with arm reach .....	14-38
Exhibit 14.4.4 (b)	Thumb and forefinger grasp boundary data for females in the 46 cm and 61 cm horizontal planes .....	14-40
Exhibit 14.4.4 (c)	Thumb and forefinger grasp boundary data for females in the 0 and -15 cm vertical planes .....	14-41
Exhibit 14.5.2.1	Male muscle strength of the arm, hand, and thumb for control forces (5th percentile values) .....	14-44
Exhibit 14.5.3.1	Horizontal push and pull forces that can be exerted .....	14-47
Exhibit 14.5.3.2	Static muscle strength data for vertical pull exertions .....	14-49

# Section 1 contents

<b>1 Introduction</b>	1-1
<b>1.1 Purpose</b>	1-1
<b>1.2 Objective</b>	1-1
<b>1.3 Scope</b>	1-1
1.3.1 HFDG in system acquisition	1-2
1.3.2 Human factors importance for COTS & NDI procurements	1-2
<b>1.4 Format</b>	1-3
1.4.1 HFDG special features	1-3
1.4.1.1 Identification and use of the HFDG rules - "shall" and "should" advice	1-3
1.4.1.2 Measurements	1-3
1.4.1.3 Topical completeness	1-4
1.4.2 Features that help find and use HFDG information	1-4
1.4.2.1 Section contents can help build checklists	1-4
1.4.2.2 Heading and text locations	1-4
1.4.2.3 Headers and footers for navigation	1-4
1.4.2.4 Exhibits combine tabular and graphics for easy use	1-4
<b>Exhibit 1.4.2.4</b> Navigating within the page format	1-5
1.4.2.5 Topical index helps find information	1-5





# 1 Introduction

The Federal Aviation Administration's (FAA) National Airspace System (NAS) modernization program introduces many new technologies (including automation technologies) that affect the numerous human interfaces within the NAS.

The *Human Factors Design Guide (HFDG) For Acquisition of Commercial-off-the-Shelf (COTS) Subsystems, Non-Developmental Items (NDI), and Developmental Systems* provides reference information to assist in the selection, analysis, design, development, and evaluation of new and modified FAA systems, facilities, and equipment.

The HFDG organization, format, style, and contents have been "human factored" for easy access and understanding of the material. As a guide, it consolidates human factors knowledge, practice, and prior experience for application to new systems and equipment.

## 1.1 Purpose

The purpose of this document is to provide a single FAA-oriented and easy-to-use source of human factors guidance. It consolidates guidance from the source materials of several government agencies and provides one reference for application to new systems associated with the FAA. It selectively draws upon documents oriented to other agency missions and adapts and expands upon them to meet the needs of FAA missions and systems.

## 1.2 Objectives

As a single consolidated reference document, the HFDG objectives are to:

- a. provide highly relevant, experience-based, general, and detailed information for use by FAA and contractor human factors professionals in system acquisitions or modifications;
- b. aid in the evaluation and selection of COTS and NDI procurements;
- c. contribute to acquisition decisions and trade-offs related to human-performance and human-interface characteristics that enhance system effectiveness and safety (see also 1.3.1);
- d. promote human-interface consistency within and among subsystems; and
- e. serve as a basis for general human factors test and evaluation information and checklist procedures.

## 1.3 Scope

The HFDG presents human factors design guidance that is to be applied to new, modified, or updated FAA facilities, systems, and equipment that will be managed, operated, and maintained by

the FAA. The guide covers a broad range of human factors topics that pertain to automation, maintenance, human interface, workplace design, documentation, system security, safety, the environment, and anthropometry. This document includes extensive human-computer interface guidance.

It is relevant to all phases of the FAA development process, from the mission need determination phase through production and deployment phases. It is to be considered for any engineering changes or modifications that affect the human interfaces within the operational system. The HFDG provides information that can be used in the evaluation and selection of COTS or NDI equipment. Similarly, it may be applied to advanced research programs that are to transition to new FAA systems.

### **1.3.1 HFDG in system acquisition**

Human factors professionals in FAA acquisition offices and on contractor development program teams will benefit by using this HFDG as a reference document to assist them with their human factors responsibilities and technical tasks.

Human factors professionals associated with program offices and integrated product development teams will be responsible for determining the applicability and relevance of topics and rules to specific systems, facilities, and equipment. Relevance will be based upon the operational missions, system functions, potential human functions or tasks, users' interface design needs, and environmental conditions. They can use this HFDG in determining system requirements through market survey, statements of work, system or equipment specifications, and system evaluations.

Contractor human factors personnel can use this guide as a basis (along with other system specific planning, analytic, prototype, simulation, developmental and evaluation processes) for the application of professional and commercial practices in human factors.

### **1.3.2 Human factors importance for COTS & NDI procurements**

To meet a particular system or equipment need within the NAS, human factors implications for COTS or NDI acquisition alternatives must be considered prior to the commitment to these alternatives. Some human factors implications include potential effects upon:

- a. human-system performance in operations and maintenance,
- b. the acceptability and usability of human-interfaces,
- c. the resultant training and personnel selection changes required,
- d. changes in human organizations and relationships, and
- e. life cycle costs and benefits.

Normally, if COTS or NDI acquisition is an option, requirements are stated in terms of function, performance, and physical characteristics in sufficient detail to enable an adequate market investigation. Then COTS or NDI alternative(s) need to be evaluated for operational suitability for the intended system purposes. Suitability criteria include safety and human factors considerations.

Human-interface changes or developments, precipitated by COTS or NDI to the intended system environment, will entail human factors analysis, prototyping, and evaluation. Where a COTS or NDI approach is selected for a new or modified system, a human factors evaluation for operational suitability is necessary. Systematic user input and selected HFDG guidelines can help. The effects on the human components and their performance are to be systematically considered and evaluated.

## 1.4 Format

Using rules outlined in section 10, User documentation, the HFDG was "human factored" to facilitate usability and readability. This section highlights the format that makes the HFDG "user-friendly."

### 1.4.1 HFDG special features

Special features of this guide, which facilitate the use of the material during applications, are discussed in this section.

#### 1.4.1.1 Identification and use of the HFDG rules - "shall" and "should" advice

This guide provides ideas and suggestions that draw upon a multiplicity of sources and experience. References are found in Appendix A.

The authors retained "shall" and "should" designations to be consistent with source materials. The "shall" text statements are identified with a solid black square (■) adjacent to the rule. Shall text statements originate from, or are judged comparable to, such statements from sources normally having the authority of the type of directives associated with FAA orders, standards, military specifications, Occupational Safety and Health Administration (OSHA), and Americans with Disabilities Act (ADA).

Each should statement is identified by an open white square (□). These rules are preferred approaches for designing new equipment or selecting between COTS alternatives. Should statements are not mandatory unless specified by contract, but are not to be ignored either.

All rule statements and sources with similar ideas and guidance are identified in Appendix B, Sources.

#### 1.4.1.2 Measurements

Measurements and dimensions used throughout the document are expressed in International System units. As a convenience, these metric units are accompanied by their customary English system equivalents in parentheses. This practice is consistent with metric standard and handbook sources.

**1.4.1.3 Topical completeness**

Topics within headings have been made as complete for reference purposes as practical by including relevant rules even though they may apply under several different topics. Where such information is repeated for topical completeness purposes, a parenthetical note states "(same as paragraph x.x. ...)." Associated information, which may be related, is noted as "(see also x.x. ...)."

Where directly relevant information is found elsewhere in the document, a cross reference, which states "(see section or paragraph x.x. ...)," is used. To ease the users' tasks, such direct cross referencing was held to a minimum.

**1.4.2 Features that help find and use HFDG information**

The HFDG format is intended to help the user navigate through, locate, and use information. The style of writing generally follows the guidelines of section 10 "User documentation" and the U.S. Government Printing Office Style Manual. The style attempts to avoid interference with reading or search flow.

**1.4.2.1 Section contents can help build checklists**

A detailed table of contents is found at the beginning of each major section to help the user navigate through all levels of topical headings, as well as through numbers and titles of all rules and exhibits. These pages can be copied to build checklists.

**1.4.2.2 Heading and text locations**

Headings provide topic announcements that help users locate information. They appear in the left-hand column.

The right-hand column is sized to facilitate scanning and reading text for in-depth understanding. Introductory text, rules, and explanatory text appear in the right-hand column. Rules, in the form of either potential design criteria or design guidelines, are distinctly numbered as paragraphs and given rule titles. Explanatory text, which supplements and explains ideas, is indented within the right column below the ideas.

**1.4.2.3 Headers and footers for navigation**

Headers and footers contain information to help the user navigate through the document. The major section topic number and name appear in the header of each page. The footer contains the page number at the outside edge of each page. Pages are numbered within each section. The footer also repeats the latest second level heading number and topic title to help orient the user to the topical structure and content of the page.

**1.4.2.4 Exhibits combine tabular and graphics for easy use**

Rather than two separate series of tables and figures, the guide has a single series of exhibits. An exhibit contains tabular information, illustrative information, or both. Thus, tabular and graphic information, which are to be used together, can be found within the same exhibit. Exhibits follow closely to the text which refers to them.

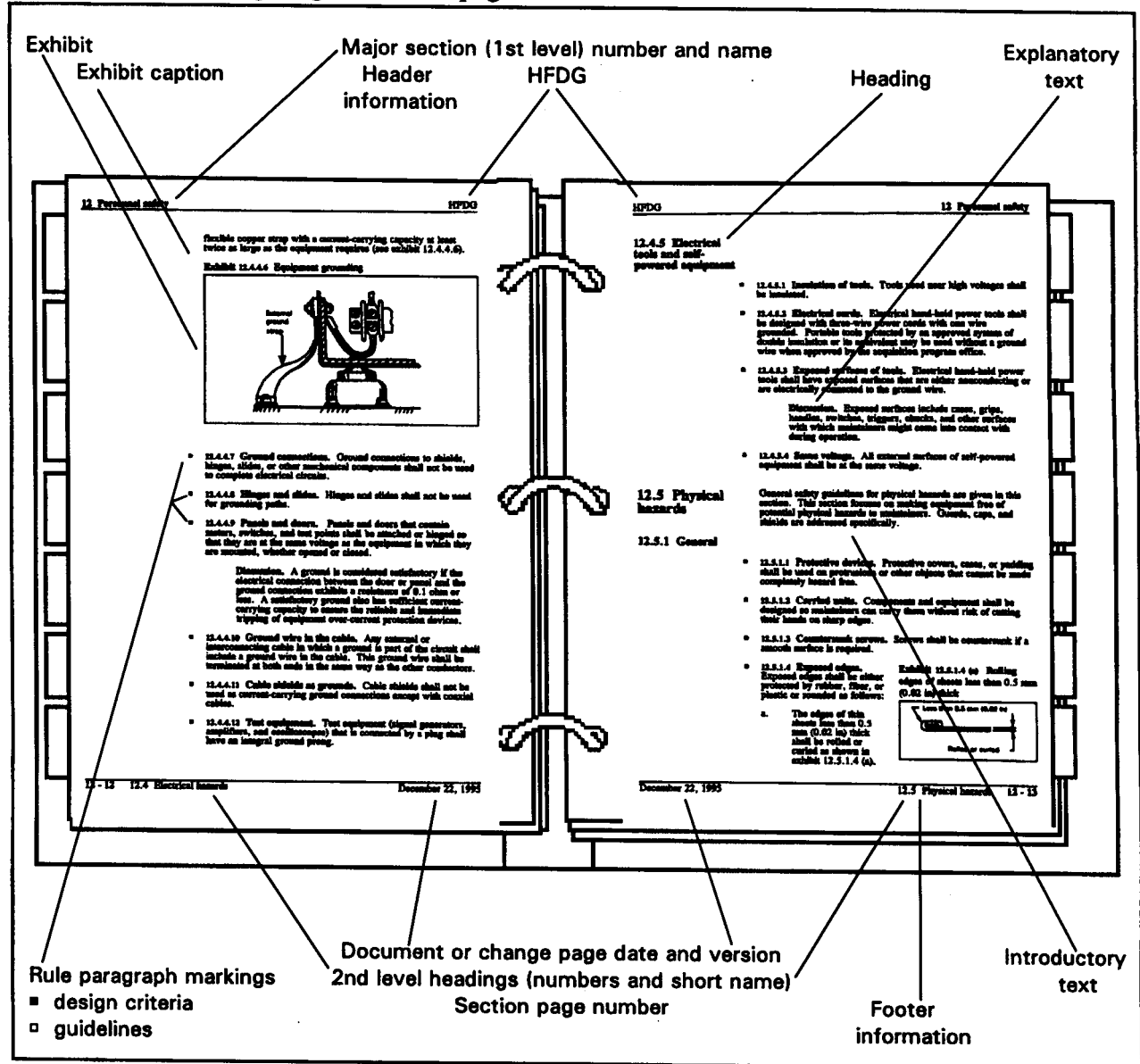
Exhibit 1.4.2.4 illustrates the format of two typical pages that contain design criteria and guidelines. The illustration shows heading information, which provides the topical structure, in the left-hand column and other textual materials in the right-hand column.

Paragraphs and rules, which provide important textual information, are shown. The location of rule markings (■ for potential design criteria and □ for potential guidelines) can be seen.

1.4.2.5 Topical index helps find information

A topical index in the back of the guide is provided to help navigate directly to the topic of inquiry.

Exhibit 1.4.2.4 Navigating within the page format



## 2 Complementary documents

When a rule found in this HFDG refers the reader to another source of information, that source of information is called a "complementary document." The complementary documents listed in this section are all contained in rules throughout the HFDG. There are two ways in which complementary documents can be used. If the rule is cited only as a guideline, then complementary documents are to be consulted for complete understanding and context of the specific rule.

If a rule of the HFDG is cited in a contractual document, then any complementary document found within that rule is also considered contractually binding. In such a case, the applicable portions of the most recent version of the complementary document would also be cited on the contract. For example, if a rule was cited on a contract that stated, ". . . shall be in accordance with MIL-W-5044," then applicable portions of MIL-W-5044 are also contractually binding. When any provision is required by law or regulation, the law or regulation would take precedence over citation of the HFDG.

Document number	Title	Paragraph number	Page number
--------------------	-------	---------------------	----------------

### 2.1 Government documents

#### 2.1.1 Specifications

##### 2.1.1.1 Military

MIL-W-5044	Walkway Compound and Non-slip Walkway Matting	9.3.3.3.1 . . . 12.2.1.7 . . .	9 - 11 12 - 2
------------	---	-----------------------------------	------------------

MIL-W-5050	Walkway Coating and Matting, Non-slip Aircraft	9.3.3.3.1 . . . 12.2.1.7 . . .	9 - 11 12 - 2
------------	--	-----------------------------------	------------------

MIL-F-15160	Fuses, Instrument, Power, and Telephone	6.13.2.1 . . .	6 - 84
-------------	---	----------------	--------

##### 2.1.1.2 FAA

FAA-D-2494/b	Technical Instruction Book Manuscript: Electronic, Electrical, and Mechanical Equipment, Requirements for Preparation of Manuscript and Production of Books	E10.4 . . . . . 10.4.4.5.3 . . .	10 - 32 10 - 37
--------------	---	-------------------------------------	--------------------

<b>Document number</b>	<b>Title</b>	<b>Paragraph number</b>	<b>Page number</b>
MIL-STD-16	Electrical and Electronic References	6.10.5.15	6 - 79
MIL-STD-17B-1	Mechanical Symbols (Other than Aeronautical, Aerospacecraft and Spacecraft Use)	10.2.4.13.2	10 - 18
MIL-STD-17-B-2	Mechanical Symbols for Aeronautical, Aerospacecraft and Spacecraft Use	10.2.4.13.2	10 - 18
MIL-STD-27	Designations for Electrical Power Switch Devices and Industrial Control Devices	10.2.4.13.1	10 - 18
MIL-STD-130	Identification Marking of U.S. Military Property	6.10.2.2.5	6 - 73
MIL-STD-195	Marking of Connections for Electrical Assemblies	6.9.1.8.1	6 - 64
MIL-STD-454	Standard General Requirements for Electronic Equipment	6.10.2.2.5	6 - 73
MIL-STD-681	Identification Coding and Application of Hookup and Lead Wire	6.9.1.8.1	6 - 64
MIL-STD-686	Cable and Cord, Electrical, Identification Marking and Color Coding of.	6.9.1.8.4	6 - 65
MIL-STD-882	System Safety Program Requirements	12.1.1	12 - 1
MIL-STD-1247	Markings, Functions and Hazard Designations of Hose, Pipe, and Tube lines for Aircraft, Missile, and Space Systems	12.16.12	12 - 31



<b>Document number</b>	<b>Title</b>	<b>Paragraph number</b>	<b>Page number</b>
------------------------	--------------	-------------------------	--------------------

MIL-STD-1473	Standard General Requirements for Color and Marking of Army Material	12.3.7 . . . .	12 - 5
--------------	--	----------------	--------

MIL-STD-1908	Definitions of Human Factors Terms	3 . . . . .	3 - 1
--------------	------------------------------------	-------------	-------

**2.1.2.2 FAA**

FAA-STD-001	Color and Texture of Finishes for National Airspace System Equipment	7.2.4.4.2 .	7 - 25
		7.2.9.1.6 .	7 - 39
		9.1.9 . . . . .	9 - 3

**2.1.2.3 Federal**

FED-STD-376	Preferred Metric Units for General Use by the Federal Government	10.2.4.11.2	10 - 17
-------------	--	-------------	---------

FED-STD-595	Colors Used in Government Procurement	E6.9.2.4.1 .	6 - 69
		7.4.1.4.5 .	7 - 61

**2.1.3 Handbooks**

DoD-HDBK-743	Anthropometry of U.S. Military Personnel	14.1.1.2 ..	14 - 2
		14.1.4.2 ..	14 - 9
		14.1.4.4 ..	14 - 10
		14.3.1.1 ..	14 - 16
		14.5.2.1 ..	14 - 43

EEOC-BK-19	American Disabilities Act Handbook	9.7.1 . . . . .	9 - 53
		9.7.2 . . . . .	9 - 54
		9.7.3 . . . . .	9 - 55

MIL-HDBK-759	Human Factors Engineering Design for Army Materiel	14.5.2.4 .	14 - 46
--------------	--	------------	---------

**2.1.4 Orders**

**2.1.4.1 FAA**

FAA-1000.15	Glossary	10.2.4.8.5 .	10 - 16
-------------	----------	--------------	---------

<b>Document number</b>	<b>Title</b>	<b>Paragraph number</b>	<b>Page number</b>
FAA-1050.14	Polychlorinated Biphenyls in the National Airspace System	12.9.6 . . . .	12 - 19
FAA-1320.1	FAA Directives System	10.4.4.5.3 . . . 10.4.12.3 . . .	10 - 37 10 - 45
FAA-1600.2	National Security Information	11.3.1.9 . . .	11 - 7
FAA-1600.8	Communications Security (COMSEC)	11.5.2.2 . . .	11 - 10
FAA-1600.54	FAA Automated Information Systems Security Handbook	11.1.2 . . . . 11.1.3 . . . . 11.1.4 . . . . 11.3 . . . . 11.3.1.9 . . . 11.3.2 . . . .	11 - 2 11 - 2 11 - 2 11 - 4 11 - 7 11 - 7
FAA-3900.19B	Occupational Safety and Health*	4.1.7 . . . . 4.2.4 . . . . 12.1.1 . . . . 12.4.1.3 . . .	4 - 2 4 - 4 12 - 1 12 - 7
	* In case of any specific conflicts with the rules in the HFDG, this complementary document has precedence in the broad areas of Occupational Health and Safety.		
FAA-3910.4	Hearing Conservation Program	13.5.1.1 . . . 13.5.1.2 . . . 13.5.1.3 . . . 13.5.1.5 . . .	13 - 14 13 - 14 13 - 14 13 - 15
FAA-7340.1	Contractions	8.1.7.2.a . . . 10.2.4.8.5 . . .	8 - 16 10 - 16

## 2.1.5 Regulations

### 2.1.5.1 Federal

10 CFR 20	Code of Federal Regulations, Title 10, Part 20	12.16.9 . . .	12 - 31
-----------	--	---------------	---------

Document number	Title	Paragraph number	Page number
21 CFR 1040	Code of Federal Regulations, Title 21, Part 1040	12.15.1 . . . 12.16.11 ..	12 - 28 12 - 31
28 CFR 35	American Disabilities Act. Regulations to implement equal employment provisions (see 2.1.3 EEOC-BK-19)	4.2.5 . . . .	4 - 4
28 CFR 36	American Disabilities Act. Non discrimination on the basis of disability in public accommodations and commercial facilities (see 2.1.3 EEOC-BK-19)	4.2.5 . . . .	4 - 4
29 CFR 1630	American Disabilities Act. Regulations to implement equal employment provisions (see 2.1.3 EEOC-BK-19)	4.2.5 . . . .	4 - 4
29 CFR 1910	Occupational Safety and Health Standards*	4.1.7 . . . . 4.2.4 . . . . 6.1.2.6 .. 6.5.9.1 .. 6.5.9.2 .. 6.6.5.1 .. 6.6.5.2 .. 6.12.1.1 .. 9.2.1.12 .. 9.3.3.4.2 . 9.3.4.4.1 . 9.3.4.4.2 . 9.3.4.4.4 . 9.3.5.6.1 . 9.3.5.6.2 . 9.3.5.7.1 . E9.3.5.7.1 (a)	4 - 2 4 - 4 6 - 3 6 - 33 6 - 33 6 - 37 6 - 37 6 - 82 9 - 4 9 - 12 9 - 15 9 - 16 9 - 16 9 - 26 9 - 26 9 - 28 9 - 29
	* In case of any specific conflicts with the rules in the HFDG, the applicable document has precedence in the broad areas of Occupational Health and Safety.	12.1.1 . . . . 12.2.1.1 .. 12.2.1.4 .. 12.2.1.5 .. 12.2.2.1 .. 12.4.1.1 .. 12.4.1.3 .. 12.4.1.11 .. 12.4.1.18 .. 12.4.2.2 .. 12.5.2.5 .. 12.6.6 . . . .	12 - 1 12 - 1 12 - 1 12 - 2 12 - 3 12 - 6 12 - 7 12 - 8 12 - 9 12 - 9 12 - 16 12 - 16

Document number	Title	Paragraph number	Page number
29 CFR 1910	Occupational Safety and Health Standards (continued)	12.7 . . . . .	12 - 16
		12.7.1 . . . . .	12 - 17
		12.7.5 . . . . .	12 - 18
		12.8.3 . . . . .	12 - 18
		12.8.4 . . . . .	12 - 18
		12.9.7 . . . . .	12 - 19
		12.11 . . . . .	12 - 20
		12.11.3 . . . . .	12 - 20
		12.11.5 . . . . .	12 - 20
		12.11.6 . . . . .	12 - 21
		12.12.8 . . . . .	12 - 22
		13.2.5 . . . . .	13 - 3
		13.2.7 . . . . .	13 - 3
	13.5.2.10. . . . .	13 - 17	
29 CFR 1926	Safety and Health Regulations for Construction*	4.1.7 . . . . .	4 - 2
		4.2.5 . . . . .	4 - 4
		12.1.1 . . . . .	12 - 1
		12.15.2 . . . . .	12 - 28
		12.15.3 . . . . .	12 - 28
		12.15.4 . . . . .	12 - 28
		12.15.6 . . . . .	12 - 29
	* In case of any specific conflicts with the rules in the HFDG, the applicable document has precedence in the broad areas of Occupational Health and Safety.		
28 CFR 35.104, 36.104	Americans with Disabilities	4.2.5 . . . . .	4 - 4
29 CFR 1630.2	Americans with Disabilities	4.2.5 . . . . .	4 - 4

### 2.1.6 Publications

FIPS PUB 112	Standard for Password Usage	11.3.2 . . . . .	11 - 7
-----------------	-----------------------------	------------------	--------

## 2.2 Nongovernment documents

American Conference of Governmental Industrial Hygienists (ACGIH) (1014 Broadway, Cincinnati OH 45202)			
	Threshold Limits Values	12.7.1 . . . . .	12 - 17

<b>Document number</b>	<b>Title</b>	<b>Paragraph number</b>	<b>Page number</b>
American National Standards Institute (ANSI) (11 W. 42nd St New York, NY 10036)			
ANSI C95.2	Radio Frequency Radiation Hazard Warning Symbol	12.16.8 . . .	12 - 31
ANSI N2.1	Radiation Symbol	12.16.10 . .	12 - 31
ANSI S3.2	Method for Measurement of Monosyllabic Word Intelligibility	7.3.5.6.1 .	7 - 52
ANSI S3.5	Methods for the Calculation of Articulation Index	7.3.5.6.1 .	7 - 52
ANSI X3.5	Flowchart Symbols for Information Processing	10.2.4.14.1	10 - 18
ANSI Y10.19	Letter Symbols for Units Used in Science and Technology	10.2.4.12.1	10 - 18
ANSI Y32.14	Graphic Symbols for Logic Diagrams (two- state devices)	10.2.4.13.3	10 - 18
ANSI Y32.16	Reference Designations for Electrical and Electronic Diagrams	10.2.4.13.1	10 - 18
ANSI Y32.2	Graphic Symbols for Electrical and Electronic Diagrams	10.2.4.13.1	10 - 18
ANSI Z535.2	Environmental and Facility Safety Signs	12.16.7 . . . 12.16.8 . . .	12 - 31 12 - 31
ANSI/ ASHRAE STD 55	Thermal Environmental Conditions for Human Occupancy	13.3 . . . . .	13 - 4
ANSI/HFS 100-1988	American National Standard for Human Factors Engineering of Visual Display Terminal Workstations	7.2.4.5.4 . 8.8.1.3 . . 8.8.4.2.6 . 9.6.1 . . . .	7 - 26 8 - 139 8 - 147 9 - 50
ANSI/IEEE 260	IEEE Standard Letter Symbols for Units of Measurements	10.2.4.8.7 . 10.2.4.11.1	10 - 16 10 - 17

<b>Document number</b>	<b>Title</b>	<b>Paragraph number</b>	<b>Page number</b>
ANSI/IEEE 268	Metric Practice	10.4.2.11.2	10 - 17
ANSI/IEEE 315A	Supplement to Graphic Symbols for Electrical and Electronics Diagrams	10.2.4.13.1	10 - 18
American Society of Mechanical Engineers (ASME) (345 East 47th St., New York, NY 10017)			
ASME Y1.1	Abbreviations for Use on Drawings and in Text	10.2.4.8.5	10 - 16
Illuminating Engineering Society (IES) of North America			
	IES Lighting Handbook SEC 9 Application-87, Industrial Lighting	13.4.1	13 - 8
The Institute of Electrical and Electronics Engineers (345 East 47th St., New York, NY 10017-2394)			
IEEE C95.1	IEEE Standard for Safety Levels with Respect to Human Exposure to Radio Frequency Electromagnetic Fields, 3 kHz to 300 GHz	12.8.4	12 - 18
NFPA 70	National Fire Protection Association	6.3.5.1.2 12.11.6	6 - 20 12 - 21

### 3 Definitions

In this section, technical terms used throughout this guide are defined. Where the authors determined the usage of a term needed to be defined in the context of its use, those definitions appear as explanatory information.

Abbreviations and acronyms used throughout this guide are also included.

The context in which the definition(s) is used is noted by the following abbreviations, given in parenthesis before the definition:

- (gen) general or human factors application
- (uci) user-computer interface
- (snv) sound, noise, and vibration
- (sec) security
- (udoc) user documentation
- (acq) acquisition

Additional definitions in the human factors area can be found in MIL-STD-1908, Definitions of Human Factors Terms.

- Abbreviation** (gen, udoc) A shortened version of a word or group of words formed by eliminating one or more letters.
- Abduction** (gen) The movement away from the midline of the body.
- Accessible** (gen) An item is considered accessible when it can be operated, manipulated, removed, or replaced by the suitably clothed and equipped user, with applicable body dimensions conforming to the anthropometric range and database specified by the acquisition program office.
- Accreditation** (sec) Authorization and approval granted to an automated information system or network to process sensitive data in an operational environment.
- Acronym** (gen) A word formed from the initial letter or letters of a group of words.
- Action level** (snv) An 8 hour time-weighted average noise level of 85 dB(A) or, equivalently, a noise dose of 50 percent.
- Action statement** (udoc) An action verb followed by the object or item acted upon.
- ADA** (gen) Americans with Disabilities Act of 1990 (see Americans with Disabilities Act)
- Adduction** (gen) The movement toward the median line.

---

<b>Advance organizer</b>	(udoc) Supplementary information that is presented prior to the main body of information in which a user is interested. Tables of contents, introductory summaries, flow charts, and adjunct questions are all advance organizers as long as they occur before the targeted information.
<b>AF</b>	(gen) Airway Facilities
<b>AIS</b>	(acq) Automated Information System
<b>Alarm</b>	(gen) Indication that a condition has been detected in which a sensor or derived parameter is out of the acceptable operating range. An alarm is the most severe category of fault. It generally requires remedial action to correct the condition and clear the alarm.
<b>Alert</b>	(gen) Indication that a condition has been detected in which a sensor or derived parameter has exceeded its ideal operating range but has not exceeded its acceptable operating range. An alert is an indication of a potential or impending alarm condition; however, in most cases service has not been affected.
<b>Alphanumeric</b>	(gen, uci) A descriptive term used to define a character set containing the letters of an ethnic alphabet, the digits 0 through 9, and generally, special symbols and punctuation marks.
<b>Americans with Disabilities Act</b>	(gen) A federal antidiscrimination statute designed to remove barriers that prevent qualified individuals with disabilities from enjoying the same employment opportunities that are available to persons without disabilities. The provision of the statute are found in the following federal regulations: 28 CFR 35.104 and 36.104, as well as 29 CFR 1630.2.
<b>ANSI</b>	(gen) American National Standards Institute
<b>Anthropometry</b>	(gen) The scientific measurement and collection of data about human physical characteristics and the application (engineering anthropometry) of these data in the design and evaluation of systems, equipment, manufactured products, human-made environments, and facilities.
<b>Appendix</b>	(udoc) A body of supplementary information collected, labeled, and placed at the end of a document.
<b>Articulation index (AI)</b>	(snv) A weighted number representing, for a given set of speech and noise conditions, the effective proportion of the normal speech signal that is available to a listener for conveying speech intelligibility. AI is computed from acoustical measurements (or estimates) of the speech spectrum and of the effective masking spectrum, and is defined on a scale of 0 to 1.0.



<b>Aspect</b>	(gen) The ratio of the horizontal to vertical dimensions of a character or image.
<b>AT</b>	(gen) Air Traffic
<b>Authentication</b>	(sec) The act of identifying and confirming the eligibility of a station, originator, or user to access specific categories of information.
<b>Authorization</b>	(sec) Granting to a user, or group, the right of access to a program, a process, or information.
<b>Authorized personnel</b>	(sec) Operators, maintainers, support or supervisory personnel, system administrators, and security personnel.
<b>Automatic test equipment</b>	(gen, acq) Test equipment that checks two or more signals in sequence without the intervention of a maintainer. The test usually stops when the first out-of-tolerance signal is detected.
<b>Automation</b>	(gen) The operation or control of a process, equipment, or subsystem without external influence -- self-regulation. Automatic processes, for the most part, lack human capabilities of volition, intention, or conscious planning and are involuntary or reflexive.
<b>A-weighted sound level [dB(A)]</b>	(snv) A sound pressure level, in decibels, measured using a sound level meter with an A-weighting network. The A-weighted response is maximum at 2500 Hz, drops rapidly as frequency decreases below 1000 Hz, and gradually decreases above 4000 Hz, thereby approximating the frequency-dependent human response to moderate sound levels.
<b>Backup</b>	(uci) A capability that returns a user to the last previous display, field, or character in a defined transaction sequence. Also refers to preserving a second copy of files for data protection purposes.
<b>Biomechanics</b>	(gen) The mechanical characteristics of biological systems, in this case the human body, in terms of physical measures and mechanical models. This field is interdisciplinary (mainly anthropometry, mechanics, physiology, and engineering). Its applications address mechanical structure, strength, and mobility of humans for engineering purposes.
<b>Brightness</b>	(gen) An attribute of visual sensation that is determined by the intensity of light radiation reaching the eye.
<b>Brightness ratio</b>	(gen) The measured luminance, at one point divided by the measured luminance, at another, equal to $L_t/L_b$ , $(L_s+L_b)/L_b$ , or $(1+L_s)/L_b$ where $L_t$ = total luminance, or luminance of the image in the presence of background; $L_s$ = luminance of the symbol without background

---

	(luminance emitted by CRT in the case of CRT displays, sometimes called trace brightness); $L_b$ = luminance of background. Brightness ratio is sometimes called contrast ratio.
<b>Browse back</b>	(gen) The action of moving to the previous window without permanently resetting system variables; however, system variables in the temporary state table will be reset.
<b>Browse exit</b>	(gen) The action of leaving browse mode.
<b>Browse next</b>	(gen) The action of moving to the succeeding window without permanently setting system variables; however, system variables will be set to a temporary state table.
<b>Built-in test equipment</b>	(gen) An integral part of a unit of equipment that can range from a simple voltmeter to a complex automatic checker.
<b>C3</b>	(gen) Command, Control, and Communications
<b>Cable</b>	(acq) A number of lines bound together within a single, permanent sheath.
<b>Cancel</b>	(uci) A capability that regenerates or re-initiates the current display without processing or retaining any changes made by the user. Cancel usually means omitting only the action of the last command.
<b>Case</b>	(acq) The part of a unit of equipment that encloses and protects the equipment from its surroundings and protects the surroundings - including maintainers - from the equipment.
<b>Caution</b>	(udoc) A written notice given when a condition might result in damage to, or destruction of, equipment or systems.
<b>Caution signal</b>	(gen) A signal that alerts the user to an impending dangerous condition requiring attention, but not necessarily immediate action.
<b>Center-justified text</b>	(udoc) Lines centered on the page. Both margins are left ragged.
<b>Certification</b>	(sec) The technical evaluation that supports the accreditation process and establishes the extent to which a particular computer system or network design meets a prespecified set of requirements.
<b>CFR</b>	(gen) Code of Federal Regulations

<b>CIE chromaticity system</b>	(gen) Allows the use of a physical measurement of the spectral energy distribution in a color to calculate the amounts of three primaries. By definition, these are the amounts of primaries required by a standard observer to obtain a visual match with the color. Any color can be matched using three primaries (red, green, and blue), but in some cases, one of the primaries must be added to the color being matched. To make calculations with the CIE chromaticity system, more convenient spectral tristimulus values are used for three colors, imaginary or primaries.
<b>Circumduction</b>	(gen) The continuous circular movement of a limb.
<b>Coding</b>	(gen) Use of a system of symbols, shapes, colors, or other variable sensory stimuli to represent specific information.
<b>Collating test equipment</b>	(acq) Test equipment that presents the results of two or more checks as a single display; for example, a light might come on only if a number of different signals are in tolerance.
<b>Comfort zone</b>	(gen) The range of environmental conditions in which humans can achieve thermal comfort.
<b>Command and control system</b>	(acq) The facilities, equipment, communications, procedures, and personnel essential to a manager for planning, directing, and controlling operations of assigned resources pursuant to the missions assigned.
<b>Command and system control equipment</b>	(acq) The main mission element, equipment, and related ground equipment used in collecting, transitioning, processing, and displaying information for command and control.
<b>Command language</b>	(uci) A limited programming language used strictly for executing a series of commands.
<b>Commercial-off-the-shelf (COTS)</b>	(acq) Items of equipment that have been developed independently by industry to meet market demands. These items may be commercial products as defined in the Federal Acquisition Regulations Part 11 or newly developed commercial items that have no market history.
<b>Commission Internationale de l'Eclairage(CIE)</b>	(gen) An international organization devoted to studying and advancing the art and science of illumination.

---

<b>Common tool</b>	(acq) A tool, routinely found in the tool supply of maintenance organizations for a similar class of system or equipment, which is generic because it is available from more than one manufacturer, and is not designed or intended for exclusive use on or with a single system or piece of equipment.
<b>Complex sentence</b>	(udoc) A simple sentence modified by one or more subordinate phrases or clauses.
<b>Component</b>	(acq) A subdivision of a unit of equipment that can be treated as an object by the maintainer, but which can be further broken down into parts. A mounting board together with its mounted parts is an example of a component.
<b>Compound sentence</b>	(udoc) Two or more simple sentences joined by a conjunction.
<b>Connector</b>	(acq) A piece of hardware that joins or attaches lines or cables to other lines or cables or to units of equipment. The term is used rather loosely to refer to either of two parts that mate with each other or to the plug that mates with a receptacle.
<b>Contrast</b>	(gen) The perception of the difference in the intensity of two areas.
<b>Contrast ratio</b>	(gen) Often specified by display manufacturers because it is numerically larger (by one) than contrast (see Brightness ratio).
<b>Control</b>	(uci) Any object that allows a user to perform an action.
<b>Control</b>	(gen) A mechanism used to regulate or guide the operation of a machine, equipment component, subsystem, or system.
<b>Controller</b>	(uci) Any device used to position the cursor on the computer monitor screen. (Examples are: mouse, joystick, cursor keys, light pen, touch screen, track ball.)
<b>Correlation coefficient (r value)</b>	(gen) The degree to which two variables vary together (positive correlation) or vary inversely (negative correlation).
<b>Corridor</b>	(gen, acq) Walkways that are physically restricted.
<b>Cover</b>	(acq) Parts of equipment that close access openings.
<b>CRT</b>	(acq, uci) Cathode Ray Tube

---

<b>Cursor</b>	(uci) A marker on the display screen that indicates the position where the computer expects the next input or will display the next output. The cursor may be positioned under computer control or by the user (see Controller).
<b>Dark adaptation</b>	(gen) The process by which the eyes become accustomed to dim light.
<b>Database</b>	(uci) A set of interrelated data stored in a computer.
<b>Data display</b>	(uci) Communication of visual, audio, or other output from a computer to its users.
<b>Data entry</b>	(uci) User input of data (numeric, textual, graphic, or analog) for computer processing and computer responses to such inputs.
<b>Data entry window</b>	(uci) Contains a set of labeled fields for entering, changing, and deleting data.
<b>Data field</b>	(uci) An area of the display screen reserved for user entry of a data item.
<b>Data field label</b>	(uci) An area of the display screen that serves as a prompt for entering a data item. It usually cannot be changed by a user.
<b>dB(A)</b>	(snv) The unit used to express sound level measured through the A-weighting network of a sound level meter (see A-weighted sound pressure level).
<b>Decibel (dB)</b>	(snv) A unit to express sound pressure level. The decibel is the unit of level when the base of the logarithm is the tenth root of ten and the quantities concerned are proportional to power. The dB has meaning only when the referenced quantity is known. The internationally accepted reference pressure in acoustics is 20 micropascals ( $\mu\text{Pa}$ ) which corresponds to 0 dB.
<b>Dedicated key</b>	(uci) A key which produces one code and is never affected by the position of either the CTRL or SHIFT keys.
<b>Default value</b>	(uci) A predetermined, frequently-used value for a data field or control entry, intended to reduce required user entry actions.
<b>Depression</b>	(gen) The lowering of a body member from its normal position.
<b>Design limits approach</b>	(gen, acq) A method of applying population or sample statistics and data about human physical characteristics to a design so that a desired portion of the user population is

---

	accommodated by the design. The range of users accommodated is a function of limits used in setting the population portion.
<b>Dialog (or dialogue)</b>	(uci) A structured series of transactions. A structured series of interchanges between a user and a computer. Dialogues can be computer initiated (question and answer) or user initiated (command languages).
<b>Disability</b>	(gen) A physical or mental impairment that substantially limits one or more of a person's major life activities.
<b>Displacement joystick</b>	(uci) A joystick that moves in the direction it is pushed. Displacement joysticks are usually spring-loaded so that they return to their center position.
<b>Display sequencing</b>	(gen, uci) A means of reducing clutter by displaying a series of partial displays or sequential data displays.
<b>DOD</b>	(gen) Department of Defense
<b>Dynamically- generated fault isolation recommendation</b>	(gen) A recommendation made by a computer system based on stored information and information received from user inputs, automated system inputs, or both. The information used by the system may include historical information, heuristics, probability factors, and cost factors. The recommendation may be derived using model-based reasoning, dependency models, fault-based reasoning, rule-based logic, information theory, or advanced artificial intelligence schema.
<b>Dynamic strength</b>	(gen) A force exerted by limbs moving in a smooth manner over time, such as while lifting an object.
<b>Effective temperature</b>	(gen) An empirical thermal index that illustrates how combinations of dry bulb air temperature, wet bulb temperature, velocity of air, and clothing affect people. This index combines into a single value the effect of temperature, humidity, and air movement on the sensation of warmth or cold felt by the human body. The numerical value is that of the temperature of still, saturated air that would induce an identical sensation.
<b>Effective watt</b>	(gen) 1.84 watts
<b>Electroluminescent device (EL)</b>	(gen) A device that produces light through electrical excitation of a phosphor.
<b>Elevation</b>	(gen) The raising of a body member from a normal position.

<b>Explosive strength</b>	(gen) The application of peak amounts of strength for short periods of time, usually periodically, such as in running or sprinting.
<b>Extension</b>	(gen) The straightening of a limb or an increase in the angle between parts of the body.
<b>FAA</b>	(gen) Federal Aviation Administration
<b>Fail-safe design</b>	(gen) Design where a failure will not adversely affect the safe operation of the system, equipment or facility.
<b>Fastener</b>	(acq) Devices that join, attach, and mount components, cases, covers, and units of equipment. They include quick fastening and releasing devices, screws, bolts, latches, catches, rivets, retainer rings, and retainer chains.
<b>Figure</b>	(udoc) An exhibit that is primarily graphical or pictorial in nature, as opposed to verbal or numerical.
<b>File</b>	(uci) A collection of data that is stored in a computer, treated as a single unit by the operating system of the computer.
<b>Flexion</b>	(gen) The process of bending of a limb or decreasing the angle between parts of the body.
<b>Fully-justified text</b>	(udoc) Spacing is added between the letters and words so that all lines are the same length, resulting in the alignment of both margins.
<b>Glare</b>	(gen) Produced when any luminance within the visual field is sufficiently greater than the luminance to which the eye is adjusted.
<b>Go, no-go test equipment</b>	(acq) Test equipment that provides one of two alternative answers to any question.
<b>Grid lines</b>	(gen, uci) Vertical lines, horizontal lines or both, extending from the scale divisions of the respective axes and intended to aid users in locating and reading data points.
<b>Guard</b>	(gen) An enclosure or barrier intended to prevent inadvertent or unauthorized operation of a control.
<b>Handle</b>	(gen, acq) A permanent part of a unit of equipment that is designed to be grasped by the hand.
<b>"Hand shaking"</b>	(sec) A question and answer dialogue whereby the computer asks questions from a previously established set.
<b>Hard copy</b>	(uci, gen) In computer graphics or telecommunications, a permanent reproduction of the data displayed or transmitted. The reproduction may be on any media

---

	suitable for direct personal use. Teletypewriter pages, continuous printed tapes, facsimile pages, computer printouts, and radiophoto prints are all examples of hard copy.
	(uci, gen) Magnetic tapes, diskettes, or nonprinted punched paper tapes are not hard copy.
<b>Hazardous condition</b>	(gen) The presence of energy or a substance which is likely to cause death or injury by reason of physical force, shock, radiation, explosion, flames, poison, corrosion, oxidation, irritation, or other debilitation. Biological and chemical hazards can have debilitating effects through disease or interference with physiological functions.
<b>Hazardous location</b>	(gen) A space within a facility, room, or open environment where a hazardous condition exists or is accessible or exposed within the system or equipment located within the space.
<b>Heading</b>	(udoc) The title of an organizational subdivision of a document.
<b>Help</b>	(uci) A capability that displays information upon user request for on-line guidance. HELP may inform a user generally about system capabilities or may provide more specific guidance in data or information handling transactions.
<b>HFDG</b>	(acq) Human Factors Design Guide; the title for the current version of this guide.
<b>Hierarchical menu</b>	(uci) A large menu that is organized as a multi level branching structure of smaller menus in which an option in a higher level menu is the name of another menu on the next lower level.
<b>Highlighting</b>	uci) Emphasizing displayed data or format features in some way, e.g., through the use of underlining, bolding, or inverse video.
<b>Hotspot</b>	(uci) The precise part of a screen pointer that marks the screen position where an operation on a pointing device will have an effect.
<b>Human-centered automation</b>	(gen, acq) Automation designed to work cooperatively with humans in pursuit of stated objectives. It may facilitate human attention and effort. Automation can be regarded as another resource to be used by those humans who are responsible for and who direct the system and its components. Human-centered automation is applied in complex systems in a manner that integrates the automatic subsystems with the human, their interfaces, and performance capabilities.



---

<b>Human interfaces</b>	(gen, acq) Design provisions that enable human interactions with other components within the operational system and with interacting systems (for example, logistics systems). Interfaces enable human-human interactions and human-hardware and -software interactions. (Human interactions and interfaces influence the organization of the system and the information that the operational system handles.)
<b>Human physical measurement characteristics</b>	(gen) The specific physical, mobility, or strength features of human users and the explicit way that a human feature or capability is measured for use as anthropometric or biomechanical data.
<b>Icon</b>	(uci) A graphic representation of a computer display that stands for objects, such as files, windows, or applications.
<b>Iconized windows</b>	(uci) Convert a window from a window to an icon.
<b>Identification</b>	(sec) The process that enables the security safeguards to recognize a user name.
<b>IES</b>	(gen) Illuminating Engineering Society of North America
<b>Illumination</b>	(gen) The amount of light (luminance flux) falling on a surface. Measured in lumen/m <sup>2</sup> = lux = 0.093 ft-c.
<b>Impairment</b>	(gen) A loss of or abnormality of physiological or anatomical structure or function.
<b>Indication statement</b>	(udoc) States the name of an indicator that the user reads or observes and the indication expected to result from the action. The stated indication is what is expected if the equipment or system is operating normally.
<b>Information</b>	(uci, gen) Organized data that users need to perform their tasks successfully. Information serves as an answer to a user's questions about data and may imply effective assimilation of data by a user. Information may include data that have been processed and formulated by automated or manual means to satisfy a knowledge requirements for use by a decision maker.
<b>Information system</b>	(uci,gen) A system, whether automated or manual, that comprises people, machines, and/or methods, organized to collect, process, transmit, and disseminate data that represent user information. A computer-supported, task oriented tool designated to help users perform defined information handling tasks.

---

<b>Input focus</b>	(uci) The notion that only one window, and usually only one object in a window at a time, is capable of accepting input from the keyboard.
<b>Interlocks</b>	(acq) Devices (for example, switches) connected with a cover, shield, or case that disable the associated internal hazard (usually electrical) when the cover, shield, or case is opened.
<b>Irradiance</b>	(gen) The radiant flux density on a given surface.
<b>Isometric joystick</b>	(gen) A joystick that responds to the amount and direction of pressure applied to it, but does not move.
<b>Item</b>	(acq) A non-specific term used to denote any product, available or in design or development, including parts, components, modules, and units of equipment.
<b>Keyboard accelerator</b>	(uci) A key or combination of keys that a user can type to select an option or menu without having to display the menu.
<b>Keyboard lockout</b>	(uci) A state determined by an application in which the application does not accept input from the keyboard.
<b>Keyguard</b>	(gen) A keyboard cover with holes over keys the user is allowed to operate.
<b>Label</b>	(gen, acq) Alphanumeric information that identifies or describes an object. Labels can be printed directly on or adjacent to the object, or they can be printed on a card or plate that is attached to the object or adjacent to the object.
<b>Lateral rotation</b>	(gen) The turning away from the midline of the body.
<b>Layout</b>	(gen, acq) The physical arrangement of the parts and components that make up a module or a unit of equipment.
<b>Left-hand page</b>	(udoc) On a two sided document the left-hand page is the page printed on the rear.
<b>Left-justified text</b>	(udoc) Text is aligned at the left margin. The right margin is left ragged.

<b>Light-emitting diode (LED)</b>	(gen) A pn-junction semiconductor device that emits incoherent optical radiation when biased in the forward direction. Primarily used in place of incandescent lamps as indicators and in alphanumeric assemblies.
<b>Limit stops</b>	(acq) Mechanisms that restrict a moving object or part by stopping it at predetermined (limit) positions.
<b>Line</b>	(acq) A single length of pipe, wire, or tubing.
<b>Linking sentence</b>	(udoc) A sentence that connects the paragraph it is in to the paragraph that precedes or follows it. The connection is usually accomplished by repeating a word or phrase or referring to a concept.
<b>Liquid crystal display (LCD)</b>	(gen) A segmented, solid state, passive display device consisting of a liquid crystal material, composed of specialized molecules, sandwiched between two conductive plates, at least one of which is transparent. Transmission of light through the medium containing the crystals is affected by the orientation of the crystals. When a current is applied, the orientation of the crystals, and therefore the transmission characteristics of the medium, are altered, resulting in contrast between particular segments/pixels and their background.
<b>List</b>	(udoc) A series of similar or related items in which each item is marked and displayed on a separate line or lines. The markings can be graphic symbols, such as bullets (●) or squares (◻), or sequential identifiers, such as numbers or letters.
<b>Location cursor</b>	(uci) An indication of the object in a window that has input focus. Its shape depends on the object; often it is a rectangle that outlines or highlights the object.
<b>Lockout</b>	(gen) A mechanical means to disable a control or switch in its safe position (for example, electrically disconnected) and to prevent its activation without the use of undue force or tools.
<b>Luminance</b>	(gen) The amount of light per unit area emitted or reflected from a surface.
<b>Luminance contrast</b>	(gen) The contrast between a figure and its background. Luminance contrast (C) is equal to the difference between the higher luminance value (L <sub>1</sub> ) and the lower (L <sub>2</sub> ) divided by the lower value (L <sub>2</sub> ): $C = (L_1 - L_2)/L_2$ .
<b>Luminance ratio</b>	(gen) The ratio of the luminance of an object to the luminance of its surroundings; the ratio of the target, subject, or symbol luminance to the surrounding field or background luminance. For projection systems, the luminance ratio is equal to the light output of a projector (measured with no film in the projector) reflected off the screen (image luminance) divided by all the light falling

on the screen (measured from the greatest viewing angle) other than that actually forming the image (nonimage or background), for example,  $LR = L/L_n$  where:  $L$ =Image or subject luminance;  $L_n$ =Nonimage or background luminance.

<b>Map</b>	(gen) A representation of geographic data.
<b>Markings</b>	(gen, acq) Nonverbal information, such as color or symbols, that identifies or describes an object. Marking can appear directly on or adjacent to the object, or it can be printed on a card or plate that is attached to the object or adjacent to the object.
<b>Master caution (warning) signal</b>	(gen) A signal that indicates that one or more caution (warning) lights have been actuated (see "Caution signal" and "Warning signal").
<b>Mechanical binding</b>	(udoc) The pages of a document are punched with either round or slotted holes and placed in a ring binder.
<b>Medial rotation</b>	(gen) The turning toward the midline of the body.
<b>Menu</b>	(uci) A list of options from which a user makes a selection.
<b>Menu bar</b>	(uci) A menu that is usually displayed horizontally across the top of the display screen.
<b>Menu function</b>	(uci) A function that causes the appearance of a menu appropriate to the location of the pointer.
<b>Menu selection</b>	(uci) A type of dialogue in which the user selects one item out of a list of displayed alternatives, whether the selection is by pointing, by entry of an associated option code, or by actuation of an assigned function key.
<b>Mnemonics</b>	(uci) A single, underlined letter for an option, different from any other in the menu.
<b>Modal window</b>	(uci) A user must interact with this window before interacting with other windows.
<b>Modeless window</b>	(uci) A user is free to interact with other windows.
<b>Modularization</b>	(acq) The separation of equipment into physically and functionally distinct units that can be easily removed and replaced.
<b>Module</b>	(acq) An assemblage of two or more interconnected parts or components that comprise a single, physical and functional entity.
<b>Mounting</b>	(acq) The positioning and attachment of parts, components, and modules.

---

<b>NAS</b>	(gen) National Airspace System
<b>Newton (N)</b>	(gen) A metric measure for force. One force pound in the English measurement system is equal to 4.4482 Newton (1 ft lb = 4.4482 N).
<b>Noise</b>	(snv) A sound having a complex character with numerous separate frequency components extending over a wide range of frequencies and not generated to convey meaning or information.
<b>Nondevelopmental item (NDI)</b>	(acq) Equipment that can be commercial-off-the-shelf (COTS), modified COTS, or previously developed. NDI can be defined as any one of the following: <ol style="list-style-type: none"><li>Item of supply that is available in the commercial marketplace (COTS).</li><li>Previously developed item of supply that is in use by a department or agency of the U.S., a state or local government, or a foreign government.</li><li>Item described above that requires only minor modification to meet the procuring agency's requirements (includes modified COTS). Minor modifications are defined as modifications that do not adversely affect safety, durability, reliability, performance, interchangeability of parts or assemblies, maintainability, weight (where weight is significant), or any other significant objective of the end item.</li><li>Item currently being produced that does not meet the above requirements solely because it is not yet in use, or not available in the commercial marketplace.</li></ol>
<b>Note</b>	(udoc) A written notice given to draw the readers attention.
<b>Object</b>	(uci) A passive entity that contains or receives information.
<b>On-line help</b>	(uci) An interactive context sensitive source of information that informs a user what entry to make at a current location in an application.
<b>Optimal visual zone</b>	(gen) Refers to a 30 degree cone symmetrical about a line from the design eye position extending outward to the center of the instrument panel, the apex of the cone being at the design eye.

---

<b>Option</b>	(uci) One of the selectable items in a menu.
<b>OSF/Motif™</b>	(gen) A trademark of the Open Software Foundation Incorporated, a graphical user interface.
<b>OSHA</b>	(gen) Occupational Safety and Health Administration
<b>Packaging</b>	(acq) The grouping of functions, components, and parts into units or modules.
<b>Packaging (of a unit of equipment)</b>	(acq) The assembling, mounting, and enclosing of the items that it includes.
<b>Paging</b>	(uci) The process of scrolling through data one page at a time.
<b>Pamphlet binding</b>	(udoc) Stitching or stapling the pages of a document together.
<b>Panel</b>	(gen) The front face of an assembly, normally used for mounting controls and displays.
<b>Panning</b>	(uci) An orientation of display framing in which a user conceives of the display frame as moving over a fixed array of data. The opposite of scrolling.
<b>Part</b>	(acq) An object that cannot normally be broken down further without destroying its designated use. Fuses, resistors, and capacitors are examples of parts.
<b>Passageway</b>	(gen, acq) Areas across which people must pass for work purposes.
<b>PC</b>	(gen) Printed Circuit
<b>PCB</b>	(gen) Polychlorinated biphenyls
<b>PEL</b>	(snv) Permissible Exposure Limit
<b>Percentile statistic</b>	(gen) Determined by ranking all data values (using the applicable measurement values related to the selected human physical characteristic) in the sample and determining the percentage of data that fall at or below a specific datum value.
<b>Percentile value</b>	(gen) The percentage of data that fall at or below a specific datum value.
<b>Perfect binding</b>	(udoc) The pages are assembled, the left side is cut and roughed, glue is applied, and the cover is glued to the pages.
<b>Person with a disability</b>	(gen) A person who has a disability, has a record of a disability, or is regarded as having a disability.

---

<b>Pica</b>	(udoc) A unit of measurement used in printing. It is equal to 0.17 inch (4.23 mm).
<b>Pixel</b>	(uci) A contraction for picture element. A pixel is a single dot on a display screen.
<b>Point</b>	(udoc) A measure of the height of type; there are 72 points in an inch (2.54 cm).
<b>Pointer</b>	(uci) A symbol displayed on the screen that is controlled by a pointing device.
<b>Pointing device</b>	(uci) A nonkeyboard device, such as a mouse, that allows a user to rapidly navigate and select items from a display screen.
<b>Pop-up menu</b>	(uci) A menu that is associated with a particular object on display.
<b>Position coding</b>	(gen, uci) The consistent placement of controls, displays, and associated information in the same physical location within identical (or similar) workstations and displays.
<b>Predefined fault isolation sequence</b>	(gen) A sequence of fixed procedures and tests that leads to a suspected fault. It is similar to a "fault tree" in a fault isolation manual.
<b>Preferred speech interference level-4 (PSIL-4)</b>	(snv) A measure of the effectiveness of noise in masking speech. It is the arithmetic mean, in decibels, of sound pressure levels in the four octave bands with center frequencies of 500, 1000, 2000, and 4000 Hz.
<b>Primary window</b>	(uci) A top or high level window in an application.
<b>Print contrast</b>	(gen, udoc) The ratio of the difference in brightness between the printing and its background to the brightness of the background (assuming dark print on a light background). It is defined by $(B1-B2)/B1$ , where B1 is the brighter of the two.
<b>Proceduralized instruction</b>	(udoc) A set of step-by-step instructions -- a procedure -- intended to ensure the successful completion of a task.
<b>Prompt</b>	(uci) A cue or reminder provided by the computer that alerts and guides the user to take some action.
<b>Pronation</b>	(gen) The downward turning of the palm, or lying face down.
<b>Pull-down menu</b>	(uci) A menu that appears when a menu bar is selected.
<b>Push button</b>	(uci) A control that appears as a bounded area (for example, a rectangle or oval) on a window.

---

<b>Qualified person with disability</b>	(gen) A person with a qualifying disability who meets legitimate skill, experience, education, or other requirements of an employment position that he or she holds or seeks. This person must be able to perform the essential functions of the position (with a reasonable accommodation, if necessary).
<b>Query</b>	(uci) The process of specifying, locating, and retrieving data matching specified characteristics from a data base.
<b>Query language</b>	(uci) A type of dialogue in which users compose control entries for displaying specified data from a data base.
<b>Question and answer</b>	(uci) A type of dialogue in which the computer displays questions, one at a time, for a user to answer.
<b>QWERTY</b>	(gen, uci) The name given to the layout of alphabetical keys on a keyboard where the left to right order of the top row is QWERTY. These keys are assigned to the left hand in the touch typing method.
<b>Reasonable accommodation</b>	(gen) Any modification or adjustment to a job or the work environment that will enable a qualified person with a disability to participate in the application process and to perform essential job functions. It may include: (1) making existing facilities readily accessible to and usable by people with disabilities, (2) restructuring jobs, (3) providing part-time or modified work schedules, (4) acquiring or modifying equipment or devices, (5) adjusting or modifying examinations, training materials or policies, (6) providing qualified readers or interpreters, and (7) other similar accommodations.
<b>Reflectance</b>	(gen) The ratio of luminous flux reflected from a surface to luminous flux striking it.
<b>RF</b>	(gen) Radio frequency
<b>Right-hand page</b>	(udoc) On a two sided document the right-hand page is the page printed on the front.
<b>Right-justified text</b>	(udoc) Text is aligned at the right margin. The left margin is left ragged.
<b>Saddle stitching</b>	(udoc) A way of binding a document which permits the document to lie flat.
<b>Saturation</b>	(gen) The relative amount of whiteness in a chromatic color.
<b>Scrolling</b>	(uci) A method used to move through the contents of a window or list in a dialogue box using the scroll bar or scroll arrows.



---

<b>Scrolling menu</b>	(uci) A menu containing many options which permits the sequential display of all options through the use of a scroll bar.
<b>Seat reference point (SRP)</b>	(gen, acq) A point in the mid-sagittal plane where surfaces of the seat back and seatpan intersect. The point at which the center line of the seat back surface (depressed) and seat bottom surface (depressed) intersect. When the seat is positioned at the midpoint of the adjustment range(s), this intersection point is called the neutral seat reference point (NSRP).
<b>Secondary window</b>	(uci) A window that is displayed from within a primary window or another secondary window.
<b>Security</b>	(sec) Physical protection, control of automated system assets and the information processed by these resources.
<b>Security architecture</b>	(sec) A subset of the overall system architecture that protects the automated system, telecommunication, physical, and informational assets through denial of service and unauthorized (accidental or intentional) disclosure, modification, or destruction.
<b>Security safeguards</b>	(sec) The protective measures and controls that are prescribed for a system. They may include, but are not necessarily limited to: operational procedures, physical security, or hardware and software features.
<b>Select function</b>	(uci) Selects or activates objects on the screen or sets the location of the cursor.
<b>Selection</b>	(uci) The action taken by a user in choosing a menu option.
<b>Service point</b>	(acq) A means for lubricating, filling, draining, charging, and similar service function. Service points allow adequate adjustment, lubrication, filling, changing, charging, and other service to be provided on all equipment and components requiring such service between overhauls.
<b>Shield</b>	(acq) Parts of equipment intended to protect components that are susceptible to damage or to protect maintainers from possible injury.
<b>Simple sentence</b>	(udoc) Consists of one subject and one predicate.
<b>Situation display</b>	(gen) A means of relating dynamic information to a map.
<b>Slider</b>	(gen) A control used to set a value and give a visual indication of the setting.
<b>Soft key</b>	(uci) An area on a screen that represents a function.

<b>Speech intelligibility</b>	(snv) A measure of the percentage of words, phrases or sentences correctly understood over a given speech communication system in a given noise situation. It may be measured by either the Phonetically Balanced (PB) Monosyllabic Word Intelligibility Test or the Modified Rhyme Test (MRT). The former consists of a list of 1,000 words in which each word is spoken and written down by a listener. The latter consists of a list of 300 words in which a word is spoken and the listener responds on a prepared multiple format selecting one of six words as the item heard. Speech intelligibility may also be predicted by the Articulation Index (AI) in which calculation is performed on the peak-speech-to-mean-square noise ratio obtained in selected frequency bands from 200 to 7,000 Hertz, i.e., peak amplitude of speech in relation to the root-mean-square amplitude of the background noise.
<b>Speech interference level</b>	(snv) A measure of the effectiveness of noise in masking speech. It is the arithmetic mean of the same pressure levels of interfering noise (in dB re $20\mu$ Pa) in the four octave bands centered on the frequencies 500, 1000, 2000, and 4000 Hz, respectively. The unit of speech interference is the decibel (dB).
<b>Specular surface</b>	(gen) A surface that provides a specular reflection, a shiny surface.
<b>Stacking</b>	(uci) The stringing together of commands so that they all will be executed with a single command.
<b>Static strength</b>	(gen) A steady force exerted while the limbs are in a stationary or static position (also known as isometric strength).
<b>Supination</b>	(gen) The upward turning of the palm, or lying face up.
<b>Supervisory control</b>	(gen) A concept derived from an analogy with the interaction between a human supervisor and an intelligent staff. In supervisory control systems, one or more human operators set, adjust, monitor, and interpret information from computers that control tasks in external processing systems. Feedback from sensors in the dynamic processes may be integrated and displayed for monitoring and "intelligent" interpretation by human or computer decision making. Human interactions involve learning, planning, teaching (programming), monitoring, detecting problems, diagnosing problems, and intervening with control actions for operations and maintenance purposes.
<b>Symbol</b>	(gen) A geometric form or alphanumeric information used to represent the state of a parameter on a display.
<b>Symbol size</b>	(gen) Actual symbol size on the display, based on eye distance from the display. Can be calculated using the following formula: $L=2D \tan (a/2)$ , where: L= size of

symbol at the display,  $D$  = design eye distance from the display,  $a$  = symbol subtense (degrees) at  $D$ .

**Syntax** (udoc) The set of rules governing a command language.

**System** (acq) A composite of equipment, skills, and techniques capable of performing or supporting an operational role, or both. A complete system includes all equipment, related facilities, material, software, services, and personnel required for its operation and support to the degree that it can be a self-sufficient unit in its intended operational environment. (Examples: National Airspace System, Remote Maintenance Monitoring System) When government furnished equipment (GFE), COTS, NDI are required for system operation, whether or not operation with GFE occurs in all cases of system operation, that GFE is part of the system.

**System engineering** (acq) A basic process for systematically defining the equipment, personnel, facilities, and procedural data required to meet system objectives. The process is iterative, requiring updating, and having feedback loops to ensure that each component developed contributes to the system in meeting mission objectives. A system engineering analysis may include, but is not necessarily limited to, the following:

- a. Preparation of operationally-realistic mission or role profiles and mission or role scenarios.
- b. Preparation of functional flow block diagrams for the system.
- c. Functional analysis of each flow block and definition of operational and support equipment and facilities requirements.
- d. Preparation of system and subsystem schematic block diagrams.
- e. Study of detailed functions, environment, and technical design requirements to allocate assignment of tasks to personnel, equipment, software, or some combination thereof.
- f. Preparation of operations and maintenance time line analyses to determine system reaction time.
- g. Preparation and analysis of operational and maintenance task data to determine equipment quantities, personnel loads, and system down-time for scheduled and unscheduled maintenance.
- h. Training implications.

---

	i.	Development of training equipment requirements.
	j.	Conduct of failure mode analysis.
	k.	Preparation of test planning analysis.
<b>Table</b>	(gen, udoc)	An array of data or text in rows and columns. Usually at least one dimension, either the rows or the columns, is labeled; sometimes both are labeled.
<b>Tagout</b>	(gen)	Tags that are attached to a control or place of hazard to identify the required control condition and hazard associated with an ongoing mode of operation or maintenance.
<b>Technical Issuances</b>	(udoc)	Publications (according to FAA Order 1320.1D) acquired from non-agency sources or developed within the FAA that directly concern installation, maintenance, or modification of equipment, equipment systems, facilities, or aircraft. Manufacturers' instruction books for plants and equipment are included in this category. A basic objective of using this category is to permit the merging of internally developed and externally acquired technical manuals and publications into consolidated, single source documents. Because of necessary deviations from standard directive format and issuance procedures, they are designated technical issuances.
<b>Test point</b>	(acq)	A means for conveniently and safely determining the operational status of equipment and for isolating malfunctions.
<b>Text entry</b>	(uci)	Initial entry and subsequent editing of textual material, including messages.
<b>Thermal comfort</b>	(gen)	A mental condition that is based upon the lack of perception of noticeable changes in temperature, which results in a personal expression of satisfaction with the environment.
<b>Title</b>	(udoc)	A word or phrase that describes or identifies the contents of a document.
<b>Toggle switch</b>	(gen, acq)	A switch with discrete positions operated by a lever.
<b>Tonal coding</b>	(gen)	Coding based on different shades of the same hue.
<b>Transaction</b>	(uci)	A user action paired with an associated computer response (or vice versa).
<b>Transilluminated display</b>	(gen)	A display in which light passes through the element being viewed. These displays include panels and indicators that use back- or edge-lighting and that use clear, translucent, fluorescent, or sandwich material.

<b>Transillumination</b>	(gen) Light passed through, rather than reflected off, an element to be viewed, e.g., illumination used on console panels or indicators utilizing edge and/or back lighting techniques on clear, translucent, fluorescent, or sandwich type materials.
<b>Tremor</b>	(gen) The oscillation of a body extremity concomitant with the effort to maintain a fixed position or direction.
<b>TWA</b>	(gen) Time Weighted Average
<b>Unit of equipment</b>	(acq) An assemblage of items that may include modules, components, and parts that are packaged together into a single hardware package. A computer, keyboard, and its visual display are all units of equipment.
<b>Unitization</b>	(acq) The packaging of equipment in physically and functionally distinct units that can be easily removed and replaced.
<b>Users</b>	(gen, sec, uci, udoc) Authorized operators, maintainers, support or supervisory personnel, system administrators, and communications personnel.
<b>VDT</b>	(gen, uci) Visual Display Terminal
<b>Ventilation</b>	(gen, acq) The process of supplying air to or removing air from any space by natural or mechanical means.
<b>Walkway</b>	(gen, acq) Areas designed for walking.
<b>Warning</b>	(gen, udoc) A written notice given when a situation might result in injury or loss of life.
<b>Warning signal</b>	(gen) A signal which alerts the operator to a dangerous condition requiring immediate action.
<b>Wet bulb globe temperature (WBGT)</b>	(gen) A meteorological measurement which can be used as an index to designate conditions of temperature and humidity at which on-set of heat stress can be expected at a particular energy expenditure level. It is calculated as follows: $WBGT=0.7T_{WBnp}+0.2t_g+0.1T_A$ , where: $T_{WBnp}$ =non-psychrometric (np) wet-bulb (WB), temperature, $T_g$ =temperature at interior center of a 15.2 cm (6 in) black globe, and $T_A$ =non-psychrometric, but shaded, dry bulb (air) temperature.
<b>Window</b>	(uci) A rectangular area on the screen that provides a visual means for interaction with an application. Applications also use windows to provide information to the user.

**Workplace** (gen) Locations where FAA personnel must go in order to operate or maintain equipment or to control the areas where equipment is installed (for on-site, on-equipment tasks), repair shops, and remote maintenance control areas. Some maintenance activities will be associated with equipment controlled by operators. Thus the same workplaces must accommodate both maintainers and operators.

**Workstation** (gen) Workplaces with special accommodations, furnishings, or equipment that are designed for the intended worker tasks. Desks, offices, repair benches, tools, equipment, and computer terminals are examples of these special accommodations and equipment. Work stations are designed as locations for one or more workers to use in accomplishing purposeful tasks or jobs.

## Section 4 contents

<b>4 General design requirements</b> .....	<b>4-1</b>
<b>4.1 Principles for designing or selecting systems and equipment</b> .....	<b>4-1</b>
□ 4.1.1 Simplicity in design .....	4-1
■ 4.1.2 Hardware and interface standardization .....	4-1
■ 4.1.3 Software standardization .....	4-1
■ 4.1.4 Standardization for maintenance .....	4-2
■ 4.1.5 Distinctive identification, interfaces, and interconnections .....	4-2
■ 4.1.6 Design for common tools .....	4-2
■ 4.1.7 Safety .....	4-2
■ 4.1.8 Fail-safe design .....	4-2
■ 4.1.9 Ruggedness .....	4-2
<b>4.2 Human performance</b> .....	<b>4-2</b>
■ 4.2.1 Design compatability .....	4-2
■ 4.2.2 Environment .....	4-3
■ 4.2.3 Protection and safety .....	4-3
■ 4.2.4 Work space .....	4-4
■ 4.2.5 Design for the disabled .....	4-4
<b>4.3 System interactions</b> .....	<b>4-4</b>
■ 4.3.1 Function allocation .....	4-5
■ 4.3.2 Operation and maintenance effectiveness .....	4-5
■ 4.3.3 Human-machine interface testing .....	4-5
■ 4.3.4 Human interactions .....	4-5
■ 4.3.5 Human physical interactions .....	4-5
■ 4.3.6 Human-computer interaction .....	4-5

□ A potential rule written as a design guideline; ■ a potential rule written as a design criterion (see 1.4.1.1).





## 4 General design requirements

This FAA *Human Factors Design Guide (HFDG) for Acquisition of Commercial-off-the-Shelf (COTS) Subsystems, Non-Developmental Items (NDI), and Developmental Systems* is a consolidated reference for human factors professionals to use as an aid in the design and evaluation of new systems and equipment. By referring to and using this document, human factors professionals can enhance the effectiveness of human-system performance in the operational environment.

This section includes general human factors rules that relate to principles for designing or selecting systems and equipment, human performance, and system interactions. To the degree that the potential design criteria and guidelines become accepted practice, or serve as a foundation for inputs to contractual agreements, they can be regarded as requirements.

### 4.1 Principles for designing or selecting systems and equipment

Design and acquisition personnel, including human factors professionals, need to recognize that the human components, their roles, and performance in operational systems require design considerations similar to those routinely given to other system components, such as hardware and software. The general principles which follow contribute to this recognition and to effective, safe systems. They relate to simplicity, standardization, safety, and ruggedness.

- **4.1.1 Simplicity in design.** The system or equipment design should be as simple as possible, consistent with the desired human-machine system functions, and compatible with the expected maintenance concepts. The resulting system or equipment should be capable of being maintained, operated, and repaired in the planned operational and maintenance environment by personnel requiring minimal training.

**Discussion.** Equipment designed with simplicity in mind is generally more reliable and easier for personnel to maintain and operate. When different designs are compared from a human factors view, the simplest design usually has less potential for human error.

- **4.1.2 Hardware and interface standardization.** Equipment and human-machine interface designs shall be standardized to the degree practical and compatible with system functions and purposes. Equipment with identical functions shall employ identical or similar hardware and human-machine interfaces.
- **4.1.3 Software standardization.** Software shall be as standardized as possible so that applications that address common functions employ the same user dialogues, interfaces, and procedures. When software improvements are necessary, the revised software shall employ the same or similar (but improved) dialogues, interfaces, and procedures to minimize maintainer and operator confusion.

- **4.1.4 Standardization for maintenance.** Identical interfaces, fasteners, switches or breakers, and connectors shall be used throughout a unit of equipment. Similarly, control, display, marking, coding, labeling, and arrangement schemes shall be the same for common functions.

**Discussion.** Standardization simplifies maintenance procedures, reduces the tools required, the potential for human error, training time, skill requirements, inventory of spares, and documentation.

- **4.1.5 Distinctive identification, interfaces, and interconnections.** Units of equipment or modules that have different functions shall be distinctive in their appearance and identification. Equipment with different functions shall have distinctive interfaces (control and display features, and connectors) so they cannot be interconnected or used erroneously.
- **4.1.6 Design for common tools.** Whenever possible, system and equipment design shall minimize auxiliary equipment and the number of tools needed for maintenance by designing for common tools available in a maintainer's tool box. Special tools shall not be designed or required for maintenance without the approval of the acquisition program office.
- **4.1.7 Safety.** System and equipment design shall incorporate applicable system and personnel safety design criteria. These criteria include those that minimize human error under normal, degraded, or emergency conditions, and under adverse environments. Such safety design criteria shall be demonstrated during development testing. Occupational Safety and Health Standards adopted by the FAA are spelled out in FAA Order 3900.19B and include 29 CFR 1910 and 29 CFR 1926. These provide minimal applicable safety and health standards for acquisition design. If any conflicts are found, the CFRs and FAA orders prevail over this guide.
- **4.1.8 Fail-safe design.** A fail-safe design shall be provided for systems whose failure could cause catastrophic damage, injury to personnel, or inadvertent operation of equipment.
- **4.1.9 Ruggedness.** Systems and equipment shall be sufficiently rugged to withstand handling during operation, maintenance, supply, and transport within the environmental limits specified in the applicable product specification.

## 4.2 Human performance

General considerations that affect human performance are presented under the topics of design compatibility, environment, protection and safety, work space, and design for the disabled.

- **4.2.1 Design compatibility.** New FAA systems, facilities, and equipment managed and maintained by the FAA shall provide the following system design features:

- a. adequate physical, visual, and auditory interfaces and communication links among personnel as well as between personnel and their equipment under normal, adverse, and emergency conditions;
  - b. provisions for minimizing the physical and psychological stress effects of task or job demands (including duration and fatigue effects);
  - c. provisions for effective handling of equipment, auxiliary equipment, and tools (including remote handling, when applicable);
  - d. compatibility of the design, location, and layout of controls, displays, workspaces, maintenance access, storage provisions, and rest provisions; and
  - e. compatibility with restrictions imposed upon personnel by clothing, personal equipment, tools, and auxiliary equipment associated with maintenance tasks.
- **4.2.2 Environment.** Design and selection of FAA systems, equipment, and facilities shall prevent the following environmental factors from degrading human performance below levels required for system operation, maintenance, training, and control:
- a. atmospheric conditions (including composition, pressure, temperature, and humidity) and other uncontrolled variable conditions (snow and floods);
  - b. acoustic noise, vibration, acceleration, shock, blast, and impact forces, as well as uncontrolled variability beyond safe limits; and
  - c. levels of natural or artificial illumination acceptable for the human tasks.
- **4.2.3 Protection and safety.** Design and selection of FAA systems, equipment, and facilities shall provide the following protection and safety characteristics:
- a. effective protection from thermal, chemical, biological, toxicological, radiological, mechanical, electrical, electromagnetic, pyrotechnic, optical, and other hazards;
  - b. provision of nonrestrictive personal life support and protective equipment where potential hazards to life or health necessitate protection;
  - c. design features to ensure efficiency, safety, ease, and economy of maintenance in normal, adverse, and emergency environments; and

- d. adequate emergency systems for contingency management, escape, survival, and rescue.

The above provisions and features for safety shall also comply with the minimal OSHA requirements of FAA Order 3900.19B, as well as 29 CFR 1910 and 29 CFR 1926.

- **4.2.4 Work space.** Design of FAA systems, equipment, and facilities shall provide the following space characteristics:
  - a. adequate space for personnel and their tools and equipment, and sufficient space for the movements and actions they perform during managerial, operational, and maintenance tasks under normal, adverse, degraded, and emergency conditions;
  - b. acceptable personnel accommodations including body support and restraint, and seating;
  - c. adequate and safe passageways, hatches, ladders, stairways, platforms, inclines, and other provisions for ingress, egress, and passage under normal, adverse, and emergency conditions; and
  - d. workflow productivity and effective arrangement of workspaces, equipment, controls, and displays.

These space characteristics (a. through d.) and those in sections 6 and 9 address efficient and safe human performance. They are based upon provisions of the Health and Safety program prescribed in FAA Order 3900.19B, 29 CFR 1910, and 29 CFR 1926. In case conflicts are found, the specifics of the OSHA regulations and FAA orders prevail.

- **4.2.5 Design for the disabled.** To comply with the Americans with Disabilities Act of 1990 (ADA) as prescribed in 28 CFR 35.104 and 36.104, as well as 29 CFR 1630.2, the acquisition program office shall determine which operations, maintenance, management, and support jobs associated with systems and equipment to be acquired will be considered open to qualified disabled persons who, with reasonable accommodation, can perform the job. In order to comply with the ADA, the acquisition program offices shall ensure that the selected jobs, the effects of associated tasks, and reasonable accommodations for the disabled are considered in the design of those new FAA systems, equipment, and facilities. Additional rules and explanations of ADA implications are found in sections 7.6, 8.10, 9.7, and 10.6.

### 4.3 System interactions

Within complex systems, humans and equipment interact in a myriad of ways to carry out the intended functions of systems and equipment. Expectations and information about these interactions influence design. Some of the general interactions and effects are presented in the rules which follow.

- **4.3.1 Function allocation.** The design of FAA systems and equipment shall incorporate the allocation of functions to maintainers, operators, equipment, and to personnel-equipment combinations to achieve:
  - a. required sensitivity, precision, reaction time, and safety;
  - b. required system reliability;
  - c. minimum number of personnel and minimum skills required to manage, operate, and maintain the system; and
  - d. the desired system and equipment performance in a cost-effective manner.
  
- **4.3.2 Operation and maintenance effectiveness.** To ensure that costly maintenance or redesign is avoided, the human-system interfaces shall be designed throughout all phases of development to optimize the efficiency and effectiveness of operation and maintenance task performance. Systems and equipment shall be designed so that they can be maintained in the least amount of time, at the lowest cost, and with a minimum expenditure of support resources.
  
- **4.3.3 Human-machine interface testing.** Appropriate consideration and incorporation of human-interface design criteria and guidelines including those from this document agreed to by a program office and contractors shall be demonstrated by human factors testing, as contractually agreed upon with the acquisition program office.

**Discussion.** FAA Order 1810.4B requires that human factors be an element of Operational Test and Evaluation planning and implementation.
  
- **4.3.4 Human interactions.** The system design shall incorporate interface features to accommodate interactions within maintainer teams as well as between these team and operations teams.
  
- **4.3.5 Human physical interactions.** Systems and equipment design shall accommodate personnel from the 5th through the 95th percentile levels of the human physical characteristics that represent the user population and the design problem. Exceptions to this range are given in explicit rules in this document or shall be approved by the acquisition program office (see section 14).
  
- **4.3.6 Human-computer interaction.** Design requirements for human-computer interaction shall be evaluated in advance of software coding (via appropriate analyses, rapid prototyping, or simulation). Human performance shall be evaluated at appropriate points in the system development and test processes as approved by the acquisition program office (see also section 8, Human-computer interfaces).

## Section 5 contents

<b>5 Maintenance automation</b>	<b>5-1</b>
<b>5.1 General goals and principles</b>	<b>5-1</b>
▪ 5.1.1 Consistency	5-2
▪ 5.1.2 Logical and explicit structure	5-2
□ 5.1.3 Simplicity	5-2
□ 5.1.4 Situation awareness	5-2
□ 5.1.5 Task compatibilities	5-3
□ 5.1.6 Human roles and workload	5-3
<b>5.2 Human-centered automation</b>	<b>5-3</b>
□ 5.2.1 Role of Automation	5-4
▪ 5.2.2 Human responsibilities	5-4
▪ 5.2.3 Responsible humans need to be involved and informed	5-4
▪ 5.2.4 Involvement through meaningful tasks	5-5
□ 5.2.5 Simple subsystem performing human-loke tasks	5-5
▪ 5.2.6 Predictable automated subsystems	5-5
▪ 5.2.7 Monitoring automated subsystems	5-6
□ 5.2.8 Monitoring humans	5-6
▪ 5.2.9 Automatic only with good reason	5-6
▪ 5.2.10 Cost effectiveness of automation	5-6
▪ 5.2.11 Analysis and evaluation of human functions	5-6
□ 5.2.12 User acceptability and performance effectiveness	5-7
▪ 5.2.13 Backup for automation	5-7
▪ 5.2.14 Automated control actions, announcements, and alternatives	5-7
▪ 5.2.15 Failure of control automation	5-7
□ 5.2.16 Workload consideration	5-7
□ 5.2.17 Human error resistance and error tolerance	5-8
▪ 5.2.18 Comprehensible automation	5-8
□ 5.2.19 Display integration	5-8
□ 5.2.20 Information automation for situation awareness	5-9
□ 5.2.21 Human responsibility for automated awareness	5-9
□ 5.2.22 Knowledge-based aids	5-9
<b>5.3 Process control lessons</b>	<b>5-9</b>
□ 5.3.1 Automated subsystems as integrated "team players"	5-10
□ 5.3.2 User information	5-10

■ 5.3.3 System analysis of complex supervisory control systems .....	5-10
□ 5.3.4 Reliability, failure mode, error, and risk analyses .....	5-11
■ 5.3.5 Human mode errors .....	5-12
□ 5.3.6 User understanding of automated functions .....	5-12
□ 5.3.7 Advanced design considerations .....	5-13
<b>5.4 Command, control, and communications .....</b>	<b>5-13</b>
■ 5.4.1 Human groups affect C <sup>3</sup> architecture .....	5-13
■ 5.4.2 Deliberate changes in human roles, functions, and tasks .....	5-14
□ 5.4.3 Models of C <sup>3</sup> systems .....	5-14
■ 5.4.4 Modes of operation .....	5-15
□ 5.4.5 Communications status displays .....	5-15
□ 5.4.6 Communications system control .....	5-16
■ 5.4.7 Communications alternatives .....	5-16
■ 5.4.8 Human interfaces with backup or rerouted communications .....	5-16
<b>5.5 System engineering .....</b>	<b>5-17</b>
■ 5.5.1 Human factors in system engineering .....	5-17
■ 5.5.2 Explicit human subsystem differences .....	5-17
□ 5.5.3 Prototyping for critical human factors issues .....	5-17
■ 5.5.4 Configuration control of the human subsystem .....	5-17
■ 5.5.5 Cognitive aspects of tasks .....	5-17
□ 5.5.6 System effectiveness models .....	5-18
<b>5.6 Human interfaces for maintenance automation .....</b>	<b>5-18</b>
■ 5.6.1 Human team interactions .....	5-18
□ 5.6.2 Avoiding disciplinary impacts on human interface design .....	5-18
■ 5.6.3 Early interface design for usability and acceptability ...	5-19
□ 5.6.4 Integrated displays and graphical representations .....	5-19
<b>5.7 Monitoring .....</b>	<b>5-19</b>
■ 5.7.1 Monitoring the remote monitoring and remote sensor components .....	5-19
□ 5.7.2 Graphical displays for monitoring system and subsystem status .....	5-19
■ 5.7.3 Updating frequency .....	5-20
□ 5.7.4 Accessibility of status information .....	5-20

□ 5.7.5 Dedicated display .....	5-20
■ 5.7.6 Control of the monitoring subsystem .....	5-20
■ 5.7.7 Identification of changes, degradations, and failures .....	5-21
□ 5.7.8 Information presentation and task compatibility .....	5-21
□ 5.7.9 Presentation of status and diagnostic information .....	5-21
□ 5.7.10 Alert and alarm characteristics .....	5-22
■ 5.7.11 False alarm rate .....	5-23
□ 5.7.12 Alarm processing and aiding .....	5-23
□ 5.7.13 Alarm and alert displays .....	5-24
■ 5.7.14 Alarm subsystem failures .....	5-24
<b>5.8 Control of remote maintenance .....</b>	<b>5-24</b>
■ 5.8.1 Selection and design of remotely controlled functions .....	5-25
□ 5.8.2 Consistent control and display features for remote switching capabilities .....	5-25
■ 5.8.3 Control of on-site maintenance .....	5-25
<b>5.9 Maintenance management information .....</b>	<b>5-25</b>
■ 5.9.1 Input and data base pruning .....	5-25
□ 5.9.2 Unnecessary reentry of data .....	5-26
■ 5.9.3 Tracking events and changes .....	5-26
■ 5.9.4 Logging, data storage, and tracking .....	5-26
□ 5.9.5 Automated log entries .....	5-26
■ 5.9.6 Logging automated aid recommendations or actions ...	5-26
■ 5.9.7 Monitor's access to the data base .....	5-27
■ 5.9.8 Maintenance technician resource interactions .....	5-27
□ 5.9.9 Separation of information system and control functions .....	5-27
□ 5.9.10 Plans and scheduled events .....	5-27
<b>5.10 Additional technical and maintenance information considerations .....</b>	<b>5-28</b>
□ 5.10.1 Potential on-line information .....	5-28
■ 5.10.2 Provisions for understanding automation features .....	5-28
□ 5.10.3 Simple to train, learn, and use .....	5-28
■ 5.10.4 Interface designs for the entry level user .....	5-28
■ 5.10.5 Training and automation .....	5-29





## 5 Maintenance automation

The FAA is developing modern solid-state communications, navigation, weather, and surveillance systems to satisfy National Airspace System (NAS) needs and to replace obsolete equipment. As part of this modernization, the agency is implementing new maintenance concepts that involve automation as well as remote maintenance and control.

Future maintenance automation programs will integrate technical data, on-line training, and procedural aids as well as interact with FAA logistics systems. Links between future technological changes in Air Traffic (AT) and Airway Facilities (AF) maintenance modernization need to be thoroughly integrated in order to maintain or improve the safety and availability of the NAS.

Maintenance modernization programs will: (1) increase centralization of management and work forces, (2) employ remote monitoring, diagnosis, and control of facilities, (3) provide easier access to maintenance management information, (4) increase efficiency and flexibility of the work force, and (5) improve safety, availability, and reliability of FAA services.

Human factors technology and applications have evolved sufficiently to make guidelines practical in the area of maintenance automation. The initial four subsections, 5.1 to 5.4, begin to capture this on-going human factors experience. Since decisions to automate require systems analytic perspectives, subsection 5.5 addresses system engineering. The next subsection, 5.6, addresses user-interfaces for automated maintenance. The following three subsections, 5.7 to 5.9, address monitoring, controlling and managing information associated with complex remote systems. The final subsection, 5.10, treats technical considerations associated with training and documentation for these complex systems.

### 5.1 General goals and principles

This general section begins with NAS goals that affect system design. Human factors efforts relevant to complex systems in aviation, power plants, and military areas are beginning to focus upon human-centered automation, process control, as well as upon command, control, and communications systems. These topics provide placeholders that await more specific FAA experience. Because topics for this section come mostly from experiences of other agencies, this section is more tutorial than most other sections.

Prioritized NAS goals with human factors implications for design are followed by general principles applicable to maintenance automation systems for the FAA.

The prioritized goals of the NAS form a basis for system effectiveness criteria in the planning, design, development, and evaluation of the human performance implications of automated

maintenance systems. Such efforts may employ analytic tools, prototyping, or simulations of the human interactions in specific systems, or subsystems of the NAS. The relevant goals are to ensure and increase:

- a. safe NAS operations for commercial, general, and military aviation,
  - b. reliability and availability of NAS facilities,
  - c. operational efficiency with minimal restrictions,
  - d. efficient and effective repair of NAS facilities, and
  - e. efficient use of NAS resources.
- **5.1.1 Consistency.** There shall be a high degree of consistency throughout the human-interfaces in maintenance automation programs and subsystems. The way that these subsystems interact with their users shall reflect this consistency within and between subsystems. Procedures, documentation, on-line help or aids, and training shall illustrate this consistency.
  - **5.1.2 Logical and explicit structure.** The human-interfaces as well as hardware and software subsystems shall reflect an obvious logic based on human-centered task needs and capabilities. The display, control, decision aid, and information structure relationships with human tasks and functions shall be clear to the users. Human-interfaces and navigation aids shall make it easy for users to know where their operational focus is in the data space and they shall be able to easily access needed data.
  - **5.1.3 Simplicity.** The human-interfaces should represent the simplest design consistent with functions and tasks of the users of the operational and maintenance subsystems. Simplicity for the user is achieved by attaining compatibility between the design and characteristics of users. Important user characteristics include human perceptual, physical, cognitive, situation awareness, and dynamic motor responsiveness capabilities. Design, including interface design, as well as human purposes dictate the human tasks. Human interfaces include control and display relationships, information structures, information communication, and feedback.
  - **5.1.4 Situation awareness.** Information presented to the user should accurately reflect system and environment status in a manner so that the user rapidly recognizes, easily understands, and easily projects system outcomes in relation to system and user goals. For example, the designer may consider displays that provide direct perception or status-at-a-glance.

**Discussion.** Situation awareness, as a concept, is a goal-oriented and experience-based moderator of human perceptual and cognitive assessments which influences decision making and actions in a complex systems environment. The concept has implication for the

integration of display information to assist users in maintaining awareness of dynamic systems.

- **5.1.5 Task compatibilities.** Automated maintenance subsystems should help the users accomplish their system functions and tasks. Information and data should be presented in easy-to-use intuitive formats and control capabilities should account for the range of safe actions.

**Discussion.** Tasks include those associated with command and control functions as well as with processes that cover normal, degraded, back-up, and emergency operational modes. Inspection, maintenance, and repair functions are pertinent. System users need to be able to access confirmatory or raw data as well as integrated display information.

- **5.1.6 Human roles and workload.** Human roles should consist of purposeful tasks with a level of workload that is not high enough to negatively affect performance, but sufficient to maintain vigilance. The system operating mechanics should minimize mental calculations or transformations and the use of recall memory (such as lengthy lists, long complex command strings, and lengthy action sequences). The system should require minimal inputs without redundant data inputs. System interfaces should be consistent with the expectations and understandings of appropriately trained personnel.

## 5.2 Human-centered automation

Designers and human factors specialists are guided by concepts and principles of human-centered automation that are emerging from the aviation and nuclear control industries. The most important consequence of automation is its effect upon the role of human components in the operational system. Automation changes cognitive tasks and decisions and may necessitate different kinds of information and actions.

Human-centered automation concepts require designers to recognize that all subsystems, even automated ones, are tools to aid and enable human individuals or teams to carry out their operational intentions. The teams' actions and those of other subsystems are evaluated in terms of how they carry out human intentions in system operations.

**Definitions. Automation** is the operation or control of a process, equipment, or subsystem without external influence -- self-regulation. Automatic processes, for the most part, lack human capabilities of volition, intention, or conscious planning and are involuntary or reflexive. Flight stability and automatic piloting subsystems are examples of automation applications. Innovative "artificial intelligence components" may somewhat aid human capabilities. The principles of human-centered automation in this section need to prevail in artificial intelligence design and use.

**Human-centered automation** is automation designed to work cooperatively with humans in pursuit of stated objectives. It may facilitate human attention and effort. Automation can be regarded as another resource to be used by those humans who are responsible for and who direct the system and its components. Human-centered automation is applied in complex systems in a manner that integrates the automatic subsystems with the human, their interfaces, and performance capabilities.

- **5.2.1 Role of Automation.** Automation should make the hardware and software system components efficient and effective support or "team players" for the human-system team. To be "team players," automated subsystems should:
  - a. be subservient rather than authoritative or autonomous in their role. (The human is ultimately responsible, thus human components need tools with accessible and practical interfaces to carry out their intentions for their system.)

**Discussion.** Automation that is authoritative, autonomous, and silent (that is, automation that does its own thing, doesn't communicate its intentions, and lacks feedback) is problematic especially when it is misunderstood, when it malfunctions, or if it cannot respond to human intentions.

- b. include constant and effective feedback to other system components (especially, to knowledgeable and responsible decision-makers, proactive monitors, controllers, and maintainers).
  - c. be directable, easy to understand, and to easy to use as a system resource that enables humans to carry out their intentions for the system.
- **5.2.2 Human responsibilities.** Human responsibilities and associated command authority shall be stated explicitly for new or modified systems. Human-centered automation exists to help humans carry out their responsibilities. Since automation is not infallible, it shall not subvert the exercise of these responsibilities. Human responsibilities include detecting failures, correcting the manifestations of failures, and continuing safe operations until they restore the system.
- **5.2.3 Responsible humans need to be involved and informed.** The system shall be designed so that users who have command, control, decision-making, diagnostic, and repair responsibilities are involved and informed consistent with their responsibilities.

**Discussion.** Automation assists humans by providing needed status, feedback, and control capabilities. This information enables those with the responsibilities, individually and as a team, to understand the state of the

system and its failures, and to continue operations in normal or degraded modes.

- **5.2.4 Involvement through meaningful tasks.** Responsible humans shall be given purposeful, meaningful and relevant tasks so they remain aware of system status and operation.

**Examples.** Possible meaningful tasks can have humans enter data about their intentions and then have the system compare them with its information. Alternatively, it may be meaningful to require humans to confirm the automation's intentions.

In the aviation flight control area, critical flight data can be obtained from an aircraft performance data base in the Flight Management System. This data could be entered automatically for flight control. But since the responsible flight crew needs to be aware of what data are being used, the system can either require them to enter the data and compare their entries with the automated selection or can have the crew confirm the data before it is used.

To just have the crew confirm the data before its use may be fast but may result in unwarranted consent by a trusting crew.

Management by proactive cross checking or by consent may be more meaningful than management by exception. Humans need to know and confirm mutual intentions in advance. They may detect exceptions too late or not at all. If the intentions of automated actions are not known, the human may prematurely and unnecessarily override the automation subsystem.

- **5.2.5 Simple subsystem performing human-like tasks.** Automated subsystems should be simple to understand and should perform tasks as humans would expect. Task failures should be obvious. If automated control actions are performed, the automated tasks should be easily understood by responsible humans and be similar to human control actions.
- **5.2.6 Predictable automated subsystems.** Automated subsystems shall be predictable so that the intent of the subsystem is known and aberrant behavior is recognized, detected and displayed to the human.

**Discussion.** Responsible humans will rely upon reliable automation. Meaningful human tasks which check the intentions, inputs, processes, or outputs of the automation may be necessary to insure that human involvement is sufficient. Otherwise automation outcomes will be accepted without questioning and critical errors and poor decisions may not be recognized or acted upon appropriately.

- **5.2.7 Monitoring automated subsystems.** The system shall be designed so that responsible humans are able to monitor the automated subsystems and the functionality of its hardware and software. Status and trend information may be necessary. Too much information may become cluttered and interfere with status, decision making, or control.
- **5.2.8 Monitoring humans.** If circumstances necessitate, automated subsystems should be able to monitor interacting human actions and to warn of human errors. To do so, automated subsystems may need to be able receive input information on human intentions.

**Discussion.** In complex systems, humans monitor each others behavior by knowledge of intents or by questioning intents. Interrelated components of a system may need to ascertain the intent of other subsystems so intentions can be compared with expectations.

- **5.2.9 Automate only with good reason.** The decision to automate functions shall answer a question as to whether the human involvements, situation awareness, or human performance in carrying out responsibilities are improved or not. Automation shall help or enable the humans to accomplish the system's mission safely, efficiently, and effectively. Choosing automation because it is technically feasible is not a sufficient reason.
- **5.2.10 Cost effectiveness of automation.** The benefits and costs of possible automation shall be considered and evaluated in the context of the specific system concept. Almost any activity (including human activities) could potentially be automated. The means, cost, and consequences (including those affecting human roles) shall be considered. Related system and human considerations for cost effectiveness follow:
  - a. long term system operations, maintenance, and personnel performance with associated costs,
  - b. degraded, emergency, and back-up modes, capabilities, and system effectiveness.
  - c. the costs and consequences (include training) of monitoring, maintaining, and updating the automation subsystems themselves, and
  - d. the operational and environmental uncertainties and expectations that could demand human analytic, decision making, and control skills.
- **5.2.11 Analysis and evaluation of human functions.** The planned allocation of functions to automation or to humans shall be carefully analyzed and evaluated in the context of the specific complex system application. Rapid prototyping and even early concept simulation can assist in these analyses and tests.

**Discussion.** Human capabilities and skills in communications, planning, problem recognition, problem solving, conceiving strategies, memory capabilities, pattern recognition, hypothesis formulation and testing, diagnosis, and analyses of unexpected events may not lend themselves to automation for certain normal, back-up, or emergency functions.

- **5.2.12 User acceptability and performance effectiveness.** The human roles, responsibilities, tasks, and interfaces that relate to automation decisions should be evaluated for user acceptability and performance effectiveness in advance of commitments to concepts or detailed design.

**Discussion.** Based upon the stage of development, user acceptance and performance can be addressed analytically, through collection of expert data, by advanced interface prototyping, or through system simulations. If performance and acceptability data differ, performance metrics may outweigh acceptability ratings. Where there is consistency in the user acceptance data, the underlying issues the warrant attention.

- **5.2.13 Backup for automation.** Designers shall ensure that the necessary functions can be performed by alternative means when the automation fails. Provisions shall be made, so that when automated subsystems fail, humans can sense failures and can perform the associated functions in back up or emergency modes.
- **5.2.14 Automated control actions, announcements, and alternatives.** Responsible humans shall be informed of automatic control action to out-of-tolerance conditions or to failures within the system. If alternative human decisions and choices are possible, the responsible humans shall be informed of the situation. When response time permits, the design shall consider permitting a confirmation or override, before automatic control takes action.

**Discussion.** If automatic timing is critical or if the consequences of the action are not critical because automated backup or redundant subsystems are present, then the responsible human may be informed of the situation, failure, and action status immediately after the implementation of the action.

- **5.2.15 Failure of control automation.** Control automation itself shall never fail silently or passively. Failure of automation control shall be unambiguously announced, so that responsible humans can take charge of the needed actions. Override and backup control alternatives shall be available for automation controls whose failure are critical to the integrity of the systems or when lives dependent on the system. Information for back-up or emergency control capability shall be readily accessible.
- **5.2.16 Workload consideration.** Control automation should be considered as a possible design option when workloads of



responsible humans warrant. Automation would assist during particularly busy and critical periods (for example, consider periods associated with back up responsibilities during wide area power losses, weather disasters, or contingency operations).

- **5.2.17 Human error resistance and error tolerance.** Control automation should be error resistant and error tolerant. Displays should be clear and responses to commands unambiguous. Safety hazard analyses and software testing should be used to reveal potential errors. Potential errors should be designed out. If a responsible operator might need to operate in out-of-tolerance conditions, then an error tolerant choice should be possible as a deliberate overriding action. In such cases, the operator should be informed of the status and warned of the condition.

**Discussion.** Use hazard instructions and warning of potential consequences when operational alternatives could be hazardous. Electronic check lists can help make the system error resistant.

- **5.2.18 Comprehensible automation.** Automated subsystems and associated integrated information displays shall be made comprehensible to responsible humans. Interactions and incompatibilities among automated modes of operation and with operational intentions are especially important and can result in memory burdens on the operator. Special considerations are necessary when control, display, or automation functions change in different modes of operation:
  - a. Mode and function identifications and status need to be clear and unambiguous to avoid confusion.
  - b. When certain modes and functions are seldom used, the memory burdens may be considerable. Identification information related to specific modes and alternatives may be necessary.
  - c. Critical periods and high workload conditions may necessitate mode and function information, decision aiding, and training considerations.
  - d. Modes, their functions, and their interactions need to be made error resistant.
- **5.2.19 Display integration.** Where display elements can be meaningfully integrated, that is combined into a more useful bigger picture, display integration should be considered and evaluated. The resulting displays should enhance status interpretation, decision making, situation awareness, or other aspects of task performance. Integrated displays should be simple and intuitive.

**Discussion.** Merely adding compiling information elements to a single or group of displays may cause significant information to be missed in the resulting clutter.

- **5.2.20 Information automation for situation awareness.** A primary objective of information automation is to maintain and enhance human situation awareness. All displays should contribute to this objective (see also paragraph 5.1.4).
- **5.2.21 Human responsibility for automated decision aids.** If decisions are automated or aided, the system, its user documentation, and its associated training should clearly indicate the human responsibilities.
- **5.2.22 Knowledge-based aids.** Knowledge-based subsystem aids should:
  - a. be capable of planning a strategy to address a problem or guide a complex process,
  - b. be consistent with cognitive strategies and expectations (mental models) associated with the users,
  - c. not require on-going user tasks to be cancelled,
  - d. minimize query of the users for information,
  - e. accept directions from the users when alternative problem solving strategies are available,
  - f. be able to explain its rules, knowledge-basis, and solutions to the user at any time during their transactions (the level of explanation detail is to be under user control),
  - g. alert the user if a problem or situation is beyond its capability, if new critical information becomes available, or if additional information is needed,
  - h. permit rapid retrieval of user exchanges and hard copy print outs of rules, facts, data consulted, hypotheses tested, and summary information,
  - i. be flexible in the types and sequencing of user inputs,
  - j. estimate and indicate the certainty of analysis and provide the rationale for the estimate, and
  - k. highlight for human monitors the changes in system status due to the use of the knowledge-based system.

### 5.3 Process control lessons

Process control lessons can be helpful in the area of complex maintenance automation. Process control concepts derived from industries in which control of manufacturing production or processing operations is especially complex, for example, gas, petroleum, electrical, and nuclear energy industries.

Where process control is applicable, certain processing variables are automatically controlled around settings that may be under human supervisory control. The supervisory controllers: (1) set

goals to regulate or fine tune the process and to keep it operating toward the system's production and safety objectives, (2) monitor subsystem and variable status, (3) detect failures, (4) diagnose and correct failures, malfunctions, or errors, and (5) take corrective control actions to maintain system objectives.

**Definition. Supervisory control** concepts were derived by Sheridan from an analogy with the interaction between a human supervisor and an intelligent staff. In supervisory control systems, one or more human operators set, adjust, monitor, and interpret information from computers that control tasks in external processing systems. Feedback from sensors in the dynamic processes may be integrated and displayed for monitoring and "intelligent" interpretation by human or computer decision making. Human interactions involve learning, planning, teaching (programming), monitoring, detecting problems, diagnosing problems, and intervening with control actions for operations and maintenance purposes.

Supervisor control offers some research insight into system complexity and help place the potential for artificial intelligence, expert knowledge-based subsystems, and decision support subsystems into the context of complex systems.

- **5.3.1 Automated subsystems as integrated "team players."** Any automated subsystems in complex process control systems should assist humans in carrying out their responsibilities and tasks efficiently and safely (see also paragraph 5.2.1).
- **5.3.2 User information.** System engineers, designers, and human factors specialists should acquire first hand knowledge of the potential users, their necessary responsibilities, potential functions, and tasks in order to identify where supervisory control support for humans may help.
- **5.3.3 System analyses of complex supervisory control systems.** System engineers, designers, and human factors specialists shall analyze complex processing systems and their potential normal, degraded, and emergency functions and modes of operation. When warranted, these analyses shall address:
  - a. human control responsibilities,
  - b. compatibility with the maintenance and manpower concepts,
  - c. potential application of supervisory control concepts,
  - d. failure modes and human-centered effects,
  - e. human tasks with an emphasis upon the cognitive aspects of the tasks, including planning, situation awareness, problem solving, memory resources, learning, decision making, and

- f. the need for artificial intelligence aids (such as knowledge-based aids) or for decision support systems. (Currently such aids do not exist in general off-the-shelf forms and would need to be developed as system specific Research, Engineering, and Development projects.)
- **5.3.4 Reliability, failure mode, error, and risk analyses.** Early in the concept development of complex processing systems, systems engineers and other developers should consider human reliability, failure, and risk analyses. Such analyses should treat humans as major components, consider human interfaces as contributing elements, and treat human performance. Analytic capabilities have been emerging in research and applications projects in avionics, automated test equipment development, aviation safety, and nuclear developments and operations. The analyses should be assessed for applicability and cost benefits to specific system issues. For instance, programs involving maintenance automation and remote maintenance control may benefit from human-centered failure mode and effects analyses.

**Discussion.** When these analysis methods are determined to be applicable, they should point to areas where human interfaces and interactions need design attention and where design enhancements could alleviate human errors and associated risks. Design functions and human tasks can be used to compare previous or alternative systems to subsystems being acquired. Analyses may exercise critical modes of operation and compare design alternatives in trade-off studies.

Human error contributions may exceed machine failures especially when a system is operating in degraded modes. Reliability block diagrams, event and fault tree analyses, failure mode and effects analyses, and human probabilistic risk assessment can treat human and system actions in terms of events, subsystems, functions, tasks, or subtasks. Human error data associated with reliability and probabilistic risk assessment can be determined from current system data, comparable data from other systems, and, if necessary, from expert judgements.

Human reliability (error) analysis is not yet an exact science. Laboratory data may not represent real world experience and thus validity for exacting results may be questioned. Nevertheless, the insights gained from the analysis processes and comparisons that they permit may warrant their serious consideration. Human errors are complex and variable in their effects. Their treatment in reliability and risk analyses can be valuable.

**Explanation.** Human errors can be determined in relationship to expected purposeful and safe system functioning. Risk is equal to the probability of an event times the consequences. Consequences can be expressed in dollar costs or in other terms of value. Uncertainty or

unreliability of components (including the human components) contribute to the concept of risk.

- **5.3.5 Human mode errors.** In some complex systems, control or display functions may change based upon operator input of a mode change or upon an automatic change of system status. When such multi-function dynamics are used, designers shall emphasize announcements and titles of mode status as well as the labeling of mode specific meanings of functions. Error resistant design considerations are necessary.

**Discussion.** Most computer users experience mode errors when typeover and insert modes go unrecognized and the meaning of certain keys change during inputs. Human mode errors of commission or omission are attributed to a lack of awareness of the current operating mode situation. Commission errors result from confusion among mode operations. Omission errors may be due to a lack of operator involvement in automatic system mode changes. In the FAA environment, mode errors could occur when a back-up system automatically takes over a service and the operator does not notice or continues to operate as if the change had not been made.

- **5.3.6 User understanding of automated functions.** Designers should draw upon and accommodate the user's understanding of functions being automated in interface design, diagnostics design, and user documentation.

**Discussion.** In some industrial plant environments, supervisory control is driven by a set of procedures established by policy. As a result, operators could have limited understandings of the system.

Inadequate or erroneous understanding of the complex system and automated functions can lead to problems of user distrust or disuse of the automation or to difficulties in problem diagnosis, status assessment, or maintenance and operational control.

**Note.** Human factors researchers hypothesize that experts develop internal cognitive "mental models" of systems, processes, components, and variable relationships that may serve them well in operational problem solving.

Mental models are founded upon individuals' experiences and upon common insights across people. This concept has potential value for the design of complex systems. A research issue is how to capture, create, design for, and train for adequate "mental models." For example, a design use would be to represent the mental models of experts or expected users graphically. Then status could be displayed and control capabilities appropriately located in the graphical representations.

- **5.3.7 Advanced design considerations.** If costs and benefits are justified, several advanced design areas should be selectively explored for application to complex processing system developments. These areas include:
  - a. evaluate potential human interfaces by rapid prototyping, analytic, or modeling approaches,
  - b. consider integrated display formats that show relationships among variables (past, current, or predicted in the future) to enhance the effectiveness of control and goal setting actions, and
  - c. explore the use of off-line system modeling which permits "what if" inquiries that could help in system diagnosis and control.

## 5.4 Command, control, and communications

FAA maintenance automation programs such as those associated with the NAS Infrastructure Management System (NIMS) have many elements that are analogous to command, control, and communications (C<sup>3</sup>) systems. Considerable military research and analyses address C<sup>3</sup> systems. A C<sup>3</sup> system attends to the integrity of its own resources and to the integrity of the facilities and resources it controls.

When system engineers, human factors specialists, and designers attend to C<sup>3</sup> aspects of the NAS, they analyze the system's information sensing, information flow, decision-making, resource control, and feedback mechanisms. To design the C<sup>3</sup> system aspects, the designers need to focus upon the human components and roles.

**Discussion.** For operational C<sup>3</sup> systems, centralized and distributed command personnel make decisions about system changes based on planning and events affecting the controlled elements. Appropriate "control" of remote information sensor resources and timely communications enable the "command" elements to activate alternative capabilities and to place the mobile resources at the right places at the right times. Communications capabilities make proactive control of the system feasible.

- **5.4.1 Human groups affect C<sup>3</sup> architecture.** From both operations and maintenance viewpoints, new or updated C<sup>3</sup> systems need to accommodate those organizations of personnel that act with common and complementary knowledge, skills, and training. System engineers and design personnel shall take into account the characteristics and any changes in these groups of human resources in designing the system.

**Discussion.** The design of the C<sup>3</sup> system needs to be compatible with the capabilities and functions of the human resource groups. These human components provide the intelligence, initiative, action, and dynamics required for the system to accomplish its mission.

Two aspects of the communications subsystem shall be monitored:

- a. the normal and backup communications structures underlying the FAA functions of remote monitoring, diagnostics, and maintenance control as well as the resources and functions for on-site repair, and
- b. the normal and backup communications structure underlying air traffic control operations as well as the AF resources needed to repair this AT equipment.

- **5.4.2 Deliberate changes in human roles, functions, and tasks.** If changes are necessary in human roles, functions, and capabilities, these changes in the new or updated system shall be deliberate objectives of the new system's design rather than fallout consequences of the design.

**Discussion.** Changes in C<sup>3</sup> systems usually require transition phases and extensive training for the human components.

- **5.4.3 Models of C3 systems.** When cost benefits warrant, system engineers, human factors specialists, and designers should consider developing models of maintenance automation improvements as C<sup>3</sup> systems. These models can be analytic, computer-based simulations, or human-in-the-loop simulations. They can assist with architecture, human-interface, component interrelationship, and other design issues. If human-subsystems are integral to safety, acceptability, or system effectiveness, human activities should be central to the models.

**Discussion.** C<sup>3</sup> system analyses and models, like the systems themselves, are potentially complex and expensive. Their developmental costs and benefits need to be assessed. They may pay for themselves many times over in terms of user involvement, acceptance, and effective safe human-system performance. To the degree that human-centered design and interface considerations can lead the conceptual design, these considerations can be cost effective in avoiding system failures, rejections, or modifications during test or operations. The insights gained from the process of constructing the models as well as the insights gained by running mission scenarios or "what if" questions can warrant the cost and effort. Models can be used to compare the old and new systems and to trade-off design alternatives within a system.

The actual modeling techniques used depend upon specific system and user context as well as issues to be addressed. Areas that can be addressed are:

- a. system responsiveness and effectiveness,

- b. information flow, work flow, and processing effectiveness,
- c. human resource impacts on architecture and effectiveness,
- d. interactions among subsystems (including human subsystems),
- e. interactions with external systems (including their human subsystems),
- f. normal, degraded, and emergency mode effectiveness,
- g. changes in components and processes,
- h. human task, and human interface effects, and
- i. maintenance concepts and strategy effects.

**Definition.** Design provisions which enable human interactions with other components within the operational system and with interacting systems (for example, logistics systems). Interfaces enable human-human interactions and human-hardware and -software interactions. (Human interactions and interfaces need to influence the organization of the system and the information that the operational system handles.)

- **5.4.4 Modes of operation.** Communications subsystem status information for maintenance support and AT operations shall be displayed for normal, backup, degraded, or emergency operations.
- **5.4.5 Communications status displays.** When warranted by system complexity, communications status displays should incorporate graphical representations that integrate the status, flow, and coverage information most needed by monitoring and controlling personnel. The displays should be based upon the task demands upon the users and the information needed.

**Examples.** The following are examples of features that might be considered for display:

- a. continuously operative communications system status displays that can show options for normal, degraded, backup, and emergency operations,
- b. communications routing status that show displays where failures have caused automatic switching to backup capabilities, or where manual or automatic rerouting is in effect,
- c. alerting and alarm indications as to the location of the problem communications equipment and the nature of the problem,



- d. failure of components that are transparent to users, for example, encryption devices and telemetry subsystems,
  - e. periodic manual or automated communications checking results, and
  - f. supportive historical and diagnostic information available for specific facilities.
- **5.4.6 Communications system control.** Communications system control capabilities should be provided directly to those personnel who are using or monitoring components of this subsystem for communication flow or maintenance.

**Examples.** The following control features are examples to be considered:

- a. provisions for notifying all or selected NAS personnel when control actions that change the systems status are necessary,
  - b. aided or automated transmission provisions when notifications of control actions or system status are numerous, and
  - c. provisions for acknowledging messages.
- **5.4.7 Communications alternatives.** Control capability for alternative communications shall be easily accessed and readily available to monitoring personnel.

**Examples.** By way of example, other features to be considered are:

- a. communications alternatives and prioritized preplanned choices need to be effectively presented to the person monitoring the communications system,
  - b. readily available control capabilities to enact flexible solutions to communications problems that are the unique result of human problem solving, and
  - c. capability to automatically log communications control actions.
- **5.4.8 Human interfaces with backup or rerouted communications.** When alternatives to the normal operating communications system are necessary, the human interfaces with the alternative systems and with interfacing automated subsystems shall be designed so that they do not become bottlenecks in continuing operations.

## 5.5 System engineering

It is vital that early requirements and system engineering efforts associated with the NAS and its subsystems address the human factors implications of maintenance automation. Decisions to automate require system analytic considerations of the human subsystem and its interfaces.

**Discussion.** The terms "system" and "subsystem" may be interchanged depending on the entity which is the focus of attention. In system theory, where interrelationships are important, almost any system is a subset or subsystem of a larger entity or system. In this context, human roles, responsibilities, functions, tasks, and performance appreciably influence the effectiveness of the system.

Human factors can not be effective if treated as an "ility." The term "ility" refers to analytic efforts that require rather complete design information to complete the analyses such as reliability, maintainability, and availability. Human factors efforts involve design creation and design integration rather than just evaluation of relatively complete design concepts or products. Human factors is integral to system engineering activities involving concept development, prototyping, and trade-offs, as well as design engineering activities such as detailed design, testing, and configuration control.

- **5.5.1 Human factors in system engineering.** Human factors efforts associated with system requirements and system engineering shall address: (1) the potential human roles, (2) new technology interactions with human components, (3) human-interface alternatives, and (4) human performance contributions to system concepts, design, and effectiveness.
- **5.5.2 Explicit human subsystem differences.** The differences between the human contributions to the current system and those associated with the new acquisition or modification program shall be made explicit in terms of how these differences are to impact design and human roles, responsibilities, performance, and interfaces.
- **5.5.3 Prototyping for critical human factors issues.** If human factors issues are critical to safety, availability, or the effectiveness of the new system or subsystem, then early prototyping of the human-interfaces and interface acceptability testing shall be accomplished prior to major concept and design commitments. When possible, such prototypes for COTS and NDI components or subsystems shall be evaluated in advance of full commitment to an "off the shelf" subsystem procurement.
- **5.5.4 Configuration control of the human subsystem.** Human components and human interfaces shall be subject to configuration management and control throughout the development process.
- **5.5.5 Cognitive aspects of tasks.** Human factors specialists shall attend to the cognitive aspects of users' operational, maintenance, and support tasks.

## 5.6 Human interfaces for maintenance automation

- **5.5.6 System effectiveness models.** When cost benefits warrant, human components and activities at either the function or task level should be included in models that estimate system effectiveness or performance (see also C<sup>3</sup> modeling in paragraph 5.4.3).

Human interfaces in complex systems associated with maintenance automation programs are treated in general terms in this section. More specific details can be found in other sections of this guide, as follows:

- a. Section 6, Designing equipment for maintenance, addresses human factors design characteristics of equipment that requires hands-on maintenance at the facility or in a maintenance shop.
  - b. Section 7, Human-equipment interfaces, addresses general control and display characteristics.
  - c. Section 8, Human-computer interfaces, addresses both media and message aspects of computer-driven processing subsystem.  
**Discussion.** Media refers to hardware and message refers to information carried in software and presented, for the most part, through screen displays.
  - d. Section 9, Workplace design, addresses console design and Visual Display Terminals.
- **5.6.1 Human team interactions.** System designers and human factors specialists shall determine the necessary human-human interactions and facilitate them through:
    - a. design provisions associated with communications links and with the layout and design of control centers, work centers, and facilities,
    - b. provisions that facilitate management control, team problem solving, and expert consultation interactions for all modes of operations, and
    - c. voice communications provisions for remotely located team members, at least, as a backup to electronic message capabilities.
  - **5.6.2 Avoiding disciplinary impacts on human interface design.** Technical design or programming personnel should not confound the users' understanding of the system or human interfaces by designing interfaces from their individual disciplinary perspectives. Designers and human factors specialists should alleviate such confounding by attending to:
    - a. the users' cognitive processes, strategies, and tasks,
    - b. systematic user inputs and evaluations in interface design,

- c. rapid prototyping and evaluation of user-interfaces, human roles, functions, responsibilities, and tasks,
  - d. simulation of human-interfaces, if cost effective, and
  - e. users' understanding, perspectives, and language.
- **5.6.3 Early interface design for usability and acceptability.** Based upon system complexity and cost effectiveness analyses but prior to software coding or other design commitments that impact human interfaces, designers shall create effective human interfaces through storyboarding, rapid prototyping, or simulations of proposed or alternative designs. User groups shall make systematic inputs to these design activities. User evaluations of interface acceptability shall be conducted.
  - **5.6.4 Integrated displays and graphical representations.** When task complexity requires them, status monitoring and diagnostic displays should employ information integration and graphical representations to enhance human performance. The displayed information interrelationships and representations should be compatible with the cognitive aspects of users' tasks (see paragraph 5.2.19).

**Discussion.** Advanced graphics capabilities permit innovative integration of relationships into three-dimensional presentations and allow for presentations of dynamic changes or trends. There are important shifts occurring in presentation of information with higher levels of automation.

## 5.7 Monitoring

Monitoring functions enable FAA managers, operators, and maintainers to compare system and subsystem status against their expectations for various modes of system operation and against ongoing and planned activities. Monitoring capabilities need to cover:

- a. the remote monitoring system itself, and
  - b. the facilities and resources being controlled.
- **5.7.1 Monitoring the remote monitoring and remote sensor components.** The remote monitoring subsystems and associated remote sensors shall be monitored and shall include a test capability at the sensors or "up the line" from the sensor, if applicable. The human interfaces for these components shall be consistent and compatible with other subsystem monitoring capabilities.
  - **5.7.2 Graphical displays for monitoring system and subsystem status.** Designers and human factors specialists should consider status displays that graphically represent the system or subsystems of interest and that show their components, functional relationships, and their operational status. If the monitoring tasks require planning information, then forecast activities and

"actions-in-progress" should be integrated with status information. Lists of exceptions or problems may not provide the interrelationship and consequence information needed as simply as a graphic representation can. Graphical representation may be used to supplement such lists with relationship information (see also paragraph 5.4.5).

- **5.7.3 Updating frequency.** Subsystem and component status shall be updated with a frequency that is compatible with those system demands associated with event detection, control, maintenance diagnosis, and repair decisions. Monitoring personnel shall be informed of the update frequencies for the various subsystems and components.
- **5.7.4 Accessibility of status information.** Monitoring tasks should call for constant and simultaneous access to status information for one or more subsystems. Designers should consider the task demands in normal, degraded, and emergency modes of operation. When necessary, they should provide for constant or simultaneous presentation of status information.
- **5.7.5 Dedicated display.** When necessary for the monitoring or controlling tasks in any mode of operation, a dedicated display of status information should be considered to ensure information availability.

**Discussion.** Where a single display is being used in a multifunctional display mode, status information could be continuously, presented in a dedicated window. A second display or a large scale display can be used if one or more users need continuous access to the status information. The mechanics of navigating through application programs to find and to present data can interfere with the tasks associated with data use. Dedicated displays can take advantage of position coding for the location of necessary information.

- **5.7.6 Control of the monitoring subsystem.** Users shall be able to set up and control the monitoring subsystem so that the following categories of information can be easily accessed:
  - a. system or subsystems requiring continuous or simultaneous status monitoring,
  - b. systems or subsystems requiring periodic, intermittent or on-call monitoring,
  - c. status of the remote maintenance technician groups,
  - d. detailed status and diagnostic information for systems, subsystems, equipment, or components requiring attention, and
  - e. settings of alert and alarm ranges and points.

- **5.7.7 Identification of changes, degradations, and failures.** Design personnel shall determine critical parameters for monitoring or diagnostic inquiry based upon appropriate analyses (such as functional, failure mode, risk, system effectiveness, maintainability, reliability, and maintenance task analyses). Human factors professionals shall systematically obtain and incorporate user inputs into the identification of changes, degradations, and failures.
- **5.7.8 Information presentation and task compatibility.** The status, change, degradation, and failure information that is presented should be compatible with the situation awareness, problem identification, system or subsystem level diagnostics, decision making, and remote control, command, and communication task needs of responsible personnel.
- **5.7.9 Presentation of status and diagnostic information.** If certain subsystems or any components are automatically monitored, analogous to supervisory process control, the following presentation features should be considered:
  - a. When status and diagnostic complexity warrants, graphic representations of the components and functions of interest are preferable.
  - b. Failures, changes, trends, or other sensed information about parameters can be overlaid onto the status representations to help the user see the effects within the bigger picture.
  - c. When appropriate and feasible, supplement status and diagnostic information with guidance indicating the actions that can be taken.
  - d. If text or other alphanumeric information is to be presented, use clear and concise plain English. Refrain from using acronyms, abbreviations, and other codings that require memorization and are subject to confusion.
  - e. Present indications of critical out-of-tolerance conditions or trends toward out-of-tolerance conditions as visual and audio alerts or alarms.

**Definitions.** The following definitions were employed in the Remote Monitoring Subsystems (RMS) requirements. An **alert** indicates that a condition has been detected in which a sensor or derived parameter has exceeded its ideal operating range but has not exceeded its acceptable operating range. An alert is an indication of a potential or impending alarm condition; however, in most cases service has not been affected. An **alarm** indicates that a condition has been detected in which a sensor or derived parameter is out of the acceptable operating range. An alarm is the most severe category of RMS fault that generally requires remedial action to correct the condition

and clear the alarm (See more general explanation with paragraph 5.7.10).

- **5.7.10 Alert and alarm characteristics.** Alert and alarm features (including any applicable automated aiding) associated with complex FAA systems should:
  - a. ensure that the operator's attention is directed by an alarm to the fact that a service, facility, system, subsystem, process, or equipment has failed or is operating in an out-of-tolerance condition,
  - b. inform the operator of the priority and nature of any deviation; four levels of priority (or preferably less) will help prevent excess operator attention from being diverted to the prioritization process,
  - c. guide the operator's initial responses,
  - d. be able to confirm in a timely manner that the operator's action corrected the deviation,
  - e. be as simple and unambiguous as possible; aiding should be not be so complex that the operator can not understand and verify its rationale and processes,
  - f. if applicable, employ trend information to alert responsible humans of pending problems and to increase their confidence in the alarm system, and
  - g. if response time will permit, provide quick means for operators to evaluate the validity of alarm signals (people often attempt validation as a first step for significant or low probability alarms).

**Explanation.** Most new FAA systems, subsystems, and equipment are assigned performance parameters that are generally optimal from a systems engineering perspective. Each parameter has an initial standard value and operating tolerance limit or range for maintenance and certification purposes. These quality control requirements are often used as alert tolerances. Exceeding alert tolerances usually means that a more serious failure is being approached, maintenance may become necessary. Alerts are sometimes called "soft alarms." Monitoring or alarm limits indicate a failure or dangerous condition for continued equipment operation or for personnel in the system has occurred. In AF operations, alerts and alarms require decisions and actions to maintain the NAS and continue its services. Operational parameters and tolerances ranges, alert levels, and alarm levels may be reset based upon operational experience.

**Note.** Alert status is not to be confused with a notice that a maintenance technician has local control of either a facility, system, or equipment. Such a notice is not an

alert but merely reflects that remote control of the facility, system, or equipment is restricted. If a technician takes equipment off line or operates it out of tolerance, the appropriate alert and alarm conditions will be sensed unless they have been suppressed or disabled.

- **5.7.11 False alarm rate.** A tolerable false alarm rate shall be established for each operational environment. If feasible, this rate shall be subject to contractor warranty and shall be minimized at near zero or a very low level.

**Discussion.** Frequent, intermittent, or critical false alarms can defeat the purpose of the indication because monitor personnel will quickly lose confidence in the alarm capability. As false alarms become irritants, the monitoring personnel could inappropriately turn them off or ignore them.

- **5.7.12 Alarm processing and aiding.** When necessary and practical, alarm processing and aiding should be selectively considered to:
  - a. indicate those critical alarms that require the most immediate operator intervention under high alarm volume situations,
  - b. support user detection, understanding, or action capability through screening of spurious alarms, time filtering, delays for momentary out-of-tolerance conditions, or sensor failures,
  - c. help the user with diagnosis by displaying the first-out alarm and subsequent alarm sequences,
  - d. ensure that operational mode or system configuration restrains alarms that are inapplicable to the current mode or configuration,
  - e. employ logical consequence processing when a single event invariably leads to subsequent alarms, then the subsequent alarms may be suppressed,
  - f. enable the operator to easily access suppressed alarms and their associated input information such as sensor parameter values, tolerance information, and problems with the sensor system, and
  - g. provide alternative interpretations of explicit alarm patterns and notification of unexpected patterns.

**Discussion.** Filtered alarms are by design not made available to operators and thus must have no operational significance to monitoring or diagnosis, decision making, or response action. Alarms that have been suppressed by maintenance personnel data by definition and design can be retrieved upon proper inquiry.



- **5.7.13 Alarm and alert displays.** Alert and alarm information displays should:
  - a. clearly support the operators capability to rapidly discern new alerts, alarms, and (if provided) their priorities, to acknowledge, verify and clear them, and to access associated information,
  - b. be conspicuously and appropriately labeled and titled,
  - c. be consistently presented in the same physical location and format and close to related control capabilities,
  - d. provide information about primary responsibility for the alarm acknowledgement and action, especially when alarm information is widely distributed,
  - e. be accessible from more than one visual display terminal, if presented through visual displays,
  - f. provide source information, parameter values, and tolerance limits or ranges in units of measurement that do not require any calculations or look-up in tables,
  - g. provide immediate operator actions associated with alarms and, at least by reference, provide procedures information,
  - h. be displayed and coded, consistent with display principles of other sections so as to provide rapid detection, interpretation, and unique precise meanings (redundant coding for shapes and colors are necessary), and
  - i. combine alarm display and related control capabilities within the same screen if practical when a visual display unit is used.
- **5.7.14 Alarm subsystem failures.** The alarm subsystem shall be testable and shall provide indication of the separate alarm subsystem components that have failed.

## 5.8 Control of remote maintenance

In the previous section, remote diagnostics were appropriately considered as part of the monitoring subsystem. It was noted that controls were necessary to focus upon the potentially faulty component and to obtain the desired diagnostic information. The result of diagnostic problem solving is to decide upon the control actions needed to optimize NAS availability and maintenance repair effectiveness. There are two categories of remote control maintenance actions which can occur independently or simultaneously and that affect the system components being monitored:

- a. control actions to adjust equipment, to switch to redundant or alternative components, or to switch off logical units in order to enhance degraded operations, and

- b. actions that call upon maintenance technicians to go to the monitored site and accomplish on-site maintenance. This category represents control of the human technician resources in a manner analogous to command and control systems.

- **5.8.1 Selection and design of remotely controlled functions.** Design personnel shall determine critical functions for designed-in redundant capabilities for automatic or remote selection. These shall be based upon appropriate analyses (such as functional, failure mode, risk, system effectiveness, maintainability, reliability, or maintenance task analyses). Similarly, remote switching functions to enhance degraded operations shall be selected based on analytic and task information.
- **5.8.2 Consistent control and display features for remote switching capabilities.** Controls, or human-computer interface commands which act as controls, should be consistent in their own form (design features), in their locations, and with respect to display features and information locations. (See sections 7 and 8 for other criteria on control and display characteristics and relationships.)
- **5.8.3 Control of on-site maintenance.** Messages that command moving and tasking of resources shall be clear and concise. These messages shall be logged (manually or automatically). Standard messages and information packets for various repair categories shall be considered. Acknowledgements of messages need to be sent and logged. Feedback shall be provided, as necessary, and management information system maintenance support shall be available upon request. Backup communications shall be available.

## 5.9 Maintenance management information

Management information systems usually consist of accessible data bases comprised of historical, operational, planning, and summarized information for management use. Inputs are required from diverse sources and outputs may serve diverse purposes. The management information system associated with FAA maintenance automation is such a system.

In this section, general rules are established to assist in design of the human factors aspects of maintenance management information systems. The section begins with rules associated with establishing and maintaining only those data that are useful. Other rules address data logging and the use of data in remote monitoring, diagnostic, and control tasks. A need to keep the control tasks and the management information system tasks from interfering with each other is addressed. Where management information can contribute to the ongoing control tasks, human interfaces need to be kept simple and straight forward or automatic and transparent to the user.

- **5.9.1 Input and data base pruning.** Management information system planners, human factors specialists, and designers shall ensure that only necessary data are included in the inputs, data

base storage, user screens, and reports. Data categories shall be subject to configuration control. Input and data base pruning shall be accomplished with systematic participation of appropriate user groups. If necessary, data bases shall be flexible enough that data categories can be easily deleted and added as system changes demand.

**Discussion.** Information processes that evolve over a period of years or that are created in the absence of information as to how the data will be used, often carry unnecessary data that are not used or that are of questionable utility. Continued entry of unnecessary data creates nonproductive work throughout the system. Data categories need to be evaluated against criteria of utility and value.

- **5.9.2 Unnecessary reentry of data.** If required current data are already available in the data base, actions calling for entry of that data should either automatically present the current relevant data to the operator for confirmation or choice, or should automatically enter the correct current data and display it to the operator.
- **5.9.3 Tracking events and changes.** Alerting and alarm events or automatic switching events shall be logged. These events shall be presented through status displays to notify the individuals monitoring the system. If manual logging is necessary, the information being logged shall also be presented to the operator through the display.

**Discussion.** Manual logging includes keyboard entry and, when necessary, written entry in a paper log. A log provides a historical basis for tracking actions and for summarizing data. The user needs to be informed of every automatic log entry and to be allowed to easily make comments, when desired.

- **5.9.4 Logging, data storage, and tracking.** When a person monitoring the system makes any significant control, diagnostic, or switching actions, these human control actions shall be entered into the log automatically, if practical. These data may be used in trend analysis, historical tracking, legal liability determinations, reenactment, or other management reporting. Only information that has approved utility for the future shall be logged (see paragraph 5.9.1), even mandatory data for logging needs to be screened periodically for its utility).
- **5.9.5 Automated log entries.** Automatic log entries for control actions should be used as needed to assist the monitoring personnel with their tasks during normal, degraded, or emergency operation.
- **5.9.6 Logging automated aid recommendations or actions.** The actions and recommendations of an automated aid that pertains to control or diagnosis shall be presented to the person

monitoring the system and, if significant, these actions and recommendations shall be logged in the data base.

- **5.9.7 Monitor's access to the data base.** Upon inquiry, the person monitoring the system shall have easy access to any historical, trend, or summary data in the data base that can help the user. Preplanned and flexible inquiries shall be possible. The inquiry task and the presentation of the data shall not interfere with on-going monitoring or diagnostic tasks. Such inquiry actions, when significant, shall be logged.

**Discussion.** Windows or separate monitors could be used to present management information so it does not interfere with the presentation of information for monitoring, diagnostic, or control tasks. Preplanned inquiry information could be integrated with status and diagnostic displays where such integration is necessary to facilitate operational tasks.

- **5.9.8 Maintenance technician resource interactions.** Routine or special interactions among personnel controlling remote maintenance and maintenance technician resources shall be logged in the management information system data base.
- **5.9.9 Separation of information system and control functions.** The maintenance monitoring and control functions should be kept separate from maintenance management information functions, except where an interface is necessary to assist performance of diagnostic or control tasks. To the extent possible, this interface should be simple and transparent for the monitoring personnel. Demands and tasks associated with the management information system should not interfere with maintenance monitoring and control tasks.

**Example.** Routine and special report requirements or functions should not interfere with monitoring and control functions or tasks.

- **5.9.10 Plans and scheduled events.** Provisions should be made for entry and retrieval of planning and scheduling information relative to inspections, on-site maintenance, and periodic maintenance of facilities and equipment. Similarly, schedule and status information pertaining to maintenance personnel resources should be provided. This planning information should be available for presentation to monitoring and technician personnel. If it is necessary as an aid to monitoring or technician tasks, this scheduling information should be integrated with the status displays.

## 5.10 Additional technical and maintenance information considerations

Additional technical information, diagnostic or maintenance information, procedural information, job aiding information, and training information are often needed as part of a maintenance automation program.

This section addresses the provision of such information in automated on-line information services or in off-line user documentation.

- **5.10.1 Potential on-line information.** The following types of user information should be considered as potentially relevant for on-line presentation to monitoring, controlling, or technician personnel if the users need and benefit from such presentation:
  - a. technical data about systems, subsystems, equipment, components, or associated functions,
  - b. procedural information,
  - c. diagnostic aiding,
  - d. training materials used as help information,
  - e. embedded training, and
  - f. job aids for navigating within the system and for making connections or obtaining information from outside the system.
- **5.10.2 Provisions for understanding automation features.** Designers shall ensure that users will be able to understand automation features by providing understandable:
  - a. appropriate human control and display design interfaces,
  - b. off-line or on-line user technical documentation,
  - c. on-line help,
  - d. off-line or on-line procedural guidance,
  - e. on-line or off-line job aids, or
  - f. training (on-line, embedded, or off-line) and training materials.
- **5.10.3 Simple to train, learn, and use.** Automation should be designed so it is simple for the users to learn, use, repair, and be trained on. Simplicity, clarity, and intuitiveness should be among the cornerstones of its design. Training considerations should be reflected in the design.
- **5.10.4 Interface designs for the entry level user.** When human-computer interfaces are used in the control of remote or automated systems, the design focus shall be on the entry-level trained user. Although, options and provisions can also be made

for "power users," the primary design focus shall be the lowest acceptable job skill level.

**Discussion.** Designers, who often are highly experienced "power users" of computer application software, need to avoid the tendency to design for others like themselves. It can take many months or years of experience for entry level operators to become "power users" of particular application packages.

Human resource selection and training needs to emphasize the primary professional skills, like maintenance diagnosis, rather than interface operation. Interfaces must not be so complex that they interfere with using the primary skills. Costs to select or train professionals to be "power users" may be prohibitive.

- **5.10.5 Training and automation.** Decisions to automate system, subsystem, or component functions shall weigh the training impacts of the potential automation as a design trade-off factor. Automation features, especially those that are complex or which change human roles and tasks, shall be analyzed for training subsystem implications. Automation features shall receive emphasis in the training analyses, training systems, training curricula, and user documentation.

**Discussion.** It is not unusual for automation features to increase the need for training because the skills and knowledge may differ from those associated non-automated equipment and may be especially demanding for degraded, back up and emergency operations as well as for diagnosis, and repair. Some increase in training is the result of having to monitor and maintain the automation subsystem itself.

## Section 6 contents

<b>6 Designing equipment for maintenance</b> .....	<b>6-1</b>
<b>6.1 General</b> .....	<b>6-1</b>
<b>6.1.1 General design guidance</b> .....	<b>6-1</b>
□ 6.1.1.1 General design guidance .....	6-2
<b>6.1.2 Emphasizing maintenance during design</b> .....	<b>6-3</b>
■ 6.1.2.1 Noninterruption of continuous operation .....	6-3
■ 6.1.2.2 Redundancy to prevent interruption .....	6-3
■ 6.1.2.3 Degraded operation .....	6-3
■ 6.1.2.4 Automation of fault detection and isolation .....	6-3
■ 6.1.2.5 Equipment independence for maintenance .....	6-3
■ 6.1.2.6 Designing for safety of maintainers .....	6-3
□ 6.1.2.7 Dividing equipment into modules .....	6-3
■ 6.1.2.8 Controls and displays for maintenance .....	6-4
■ 6.1.2.9 Replacement of failed components .....	6-4
<b>6.1.3 Use of existing or common equipment and tools</b> .....	<b>6-4</b>
■ 6.1.3.1 Use of existing items .....	6-4
■ 6.1.3.2 Interchangeability of items .....	6-4
■ 6.1.3.3 Noninterchangeable items .....	6-4
■ 6.1.3.4 Minimize maintenance equipment and tools .....	6-4
■ 6.1.3.5 Use common test equipment and tools .....	6-4
■ 6.1.3.6 Special tools .....	6-4
<b>6.1.4 Optimize skills and training</b> .....	<b>6-5</b>
■ 6.1.4.1 Optimize balance between use, maintenance, and special skills .....	6-5
■ 6.1.4.2 Optimize balance between ease of use and training .....	6-5
<b>6.1.5 Minimizing need for maintenance</b> .....	<b>6-5</b>
■ 6.1.5.1 Ease of servicing .....	6-5
■ 6.1.5.2 Minimize maintenance time .....	6-5

<b>6.2 Designing equipment for handling</b>	6-5
<b>6.2.1 General</b>	6-5
▪ 6.2.1.1 Maintainer efficiency and safety	6-5
▪ 6.2.1.2 Prevention of damage	6-5
▪ 6.2.1.3 Minimal number of maintainers	6-5
<b>6.2.2 Weight</b>	6-6
▪ 6.2.2.1 Maximum weight of units of equipment to be lifted by one person	6-6
<b>Exhibit 6.2.2.1</b> Maximum weight limits for objects lifted by one person using both hands	6-6
▪ 6.2.2.2 Lifting in the presence of obstacles	6-6
▪ 6.2.2.3 Maximum weight of units of equipment to be lifted by two people	6-6
▪ 6.2.2.4 Maximum weight of units of equipment to be lifted by three or more people	6-6
▪ 6.2.2.5 Maximum weight of units of equipment to be carried by one person	6-7
▪ 6.2.2.6 Maximum weight of units of equipment to be carried by more than one person	6-7
▪ 6.2.2.7 Maximum weight of units of equipment to be carried by more than two people	6-7
▪ 6.2.2.8 Lifting eyes or jacking points	6-7
□ 6.2.2.9 Reducing weight by removing parts	6-7
▪ 6.2.2.10 Labeling heavy units	6-7
<b>6.2.3 Size</b>	6-7
□ 6.2.3.1 Desirable size	6-7
□ 6.2.3.2 Reducing size by removing parts	6-7
<b>6.2.4 Shape</b>	6-8
▪ 6.2.4.1 Avoiding protuberances	6-8
▪ 6.2.4.2 Removing protuberances	6-8
<b>6.2.5 Handles</b>	6-8
<b>6.2.5.1 When handles are needed</b>	6-8
▪ 6.2.5.1.1 Units of equipment designed for carrying	6-8
▪ 6.2.5.1.2 Units of equipment weighing less than 4.5 kg (10 lb)	6-8
▪ 6.2.5.1.3 Units of equipment weighing between 4.5 and 18 kg (10 to 40 lb)	6-8



▪ 6.2.5.1.4	Units of equipment weighing between 18 and 68 kg (40 to 150 lb)	6-8
▪ 6.2.5.1.5	Force limits	6-8
	<b>Exhibit 6.2.5.1.5</b> Maximum force limits for pulling and pushing units of equipment using handles or grasp areas	6-9
<b>6.2.5.2</b>	<b>Handle characteristics</b>	<b>6-9</b>
▪ 6.2.5.2.1	Handle comfort	6-9
▪ 6.2.5.2.2	Handle surface	6-9
▪ 6.2.5.2.3	Handle conductivity	6-9
▪ 6.2.5.2.4	Handle attachment	6-9
▪ 6.2.5.2.5	Recessed, hinged, and folding handles	6-9
▪ 6.2.5.2.6	Stops for hinged or folding handles	6-9
<b>6.2.5.3</b>	<b>Dimensions</b>	<b>6-9</b>
▪ 6.2.5.3.1	Minimum handle dimensions by type of handle and hand covering	6-10
	<b>Exhibit 6.2.5.3.1</b> Minimum handle dimensions	6-10
▪ 6.2.5.3.2	Minimum handle diameter by weight of unit of equipment	6-11
	<b>Exhibit 6.2.5.3.2</b> Minimum handle diameter required by weight of unit of equipment	6-11
▪ 6.2.5.3.3	Finger curl	6-11
<b>6.2.5.4</b>	<b>Location</b>	<b>6-11</b>
□ 6.2.5.4.1	Single handles	6-11
□ 6.2.5.4.2	Pairs of handles	6-11
▪ 6.2.5.4.3	Exposure to hazards	6-11
▪ 6.2.5.4.4	Structural clearance	6-11
<b>6.2.6</b>	<b>Grasp areas</b>	<b>6-11</b>
□ 6.2.6.1	Location of grasp area	6-11
▪ 6.2.6.2	Grasp area finish	6-11
▪ 6.2.6.3	Grasp area material	6-12
▪ 6.2.6.4	Grasp area conductivity	6-12
<b>6.2.7</b>	<b>Stands and rests</b>	<b>6-12</b>
▪ 6.2.7.1	Prevention of damage	6-12
▪ 6.2.7.2	Integral to chassis	6-12
□ 6.2.7.3	Handles as stands or rests	6-12

<b>6.2.8 Alignment aids</b>	.....	<b>6-12</b>
▪ 6.2.8.1 Guides, tracks, and stops	.....	6-12
▪ 6.2.8.2 Prevention of improper mounting	.....	6-12
□ 6.2.8.3 Alignment of light-weight units of equipment	.....	6-12
□ 6.2.8.4 Alignment of heavy units of equipment	.....	6-12
▪ 6.2.8.5 Labeling units of equipment	.....	6-12
▪ 6.2.8.6 Labeling insertion holes	.....	6-12
<b>6.2.9 Designing for remote handling</b>	.....	<b>6-13</b>
▪ 6.2.9.1 Alignment aids	.....	6-13
▪ 6.2.9.2 Quick-action connectors	.....	6-13
▪ 6.2.9.3 Fasteners	.....	6-13
▪ 6.2.9.4 Latches	.....	6-13
<b>6.2.10 Designing for use of hoists, jacks, and cranes</b>	.....	<b>6-13</b>
▪ 6.2.10.1 Lifting eyes or jacking points	.....	6-13
▪ 6.2.10.2 Location of assistance points	.....	6-13
▪ 6.2.10.3 Labeling	.....	6-13
<b>6.3 Packaging, arrangement, and mounting of equipment</b>	.....	<b>6-13</b>
<b>6.3.1 Unitization of equipment</b>	.....	<b>6-14</b>
▪ 6.3.1.1 Functional independence	.....	6-14
▪ 6.3.1.2 Packaging equipment	.....	6-14
▪ 6.3.1.3 Ease of installation	.....	6-14
▪ 6.3.1.4 Independent adjustment	.....	6-14
□ 6.3.1.5 Handling by one person	.....	6-14
▪ 6.3.1.6 Interconnectivity	.....	6-15
▪ 6.3.1.7 Protrusions	.....	6-15
□ 6.3.1.8 Prevention of incorrect mounting	.....	6-15
<b>6.3.2 Interchangeability, noninterchangeability</b>	.....	<b>6-15</b>
▪ 6.3.2.1 Interchangeability of equivalent units of equipment	.....	6-15
▪ 6.3.2.2 Identifiability of interchangeable units of equipment	.....	6-15

<ul style="list-style-type: none"> <li>▪ 6.3.2.3 Noninterchangeability of nonequivalent units of equipment ..... 6-15</li> <li>▪ 6.3.2.4 Identifiability of noninterchangeable units of equipment ..... 6-15</li> </ul>	
<b>6.3.3 Mounting in drawers, on racks, and on hinges</b>	<b>6-15</b>
<b>6.3.3.1 General</b>	<b>6-15</b>
<ul style="list-style-type: none"> <li>▪ 6.3.3.1.1 Mounting frequently-moved units of equipment ..... 6-15</li> <li>▪ 6.3.3.1.2 Mounting of heavy units of equipment ..... 6-16</li> <li>▪ 6.3.3.1.3 Access to rear or bottom of units of equipment ..... 6-16</li> <li>▪ 6.3.3.1.4 Avoidance of instability ..... 6-16</li> <li>□ 6.3.3.1.5 Attachment of equipment ..... 6-16</li> <li>▪ 6.3.3.1.6 Ease of moving mounted units of equipment ..... 6-16</li> <li>▪ 6.3.3.1.7 Maximum force to move mounted units of equipment ..... 6-16</li> <li>□ 6.3.3.1.8 Guards and shields ..... 6-16</li> </ul>	
<b>6.3.3.2 Restraints and supports</b>	<b>6-16</b>
<ul style="list-style-type: none"> <li>▪ 6.3.3.2.1 Limit stops ..... 6-16</li> <li>▪ 6.3.3.2.2 Automatic locks ..... 6-16</li> <li>▪ 6.3.3.2.3 Lock release ..... 6-17</li> <li>▪ 6.3.3.2.4 Supports for hinge-mounted equipment ..... 6-17</li> </ul>	
<b>6.3.3.3 External connectors and interlocks</b>	<b>6-17</b>
<ul style="list-style-type: none"> <li>▪ 6.3.3.3.1 Preservation of external connections ..... 6-17</li> <li>▪ 6.3.3.3.2 Breaking of external connections ..... 6-17</li> <li>▪ 6.3.3.3.3 External connectors as part of supporting structure ..... 6-17</li> </ul>	
<b>6.3.4 Positioning equipment</b>	<b>6-17</b>
<b>6.3.4.1 Physical accessibility</b>	<b>6-17</b>
<ul style="list-style-type: none"> <li>▪ 6.3.4.1.1 Complete visual and physical access ..... 6-17</li> <li>▪ 6.3.4.1.2 Freedom from structural obstruction ..... 6-18</li> <li>▪ 6.3.4.1.3 Working space ..... 6-18</li> <li>▪ 6.3.4.1.4 Room to open covers ..... 6-18</li> <li>▪ 6.3.4.1.5 Stacking or blocking equipment ..... 6-18</li> <li>▪ 6.3.4.1.6 Full extension or rotation ..... 6-18</li> <li>□ 6.3.4.1.7 Working level ..... 6-18</li> <li>▪ 6.3.4.1.8 Visual access ..... 6-18</li> <li>▪ 6.3.4.1.9 Removal path ..... 6-18</li> </ul>	

<b>6.3.4.2 Relative accessibility</b>	.....	<b>6-18</b>
▪ 6.3.4.2.1 Criticality of equipment	.....	6-18
▪ 6.3.4.2.2 Frequency of access	.....	6-19
▪ 6.3.4.2.3 Grouping to minimize movement	.....	6-19
▪ 6.3.4.2.4 Noninteraction with equipment maintained by others	.....	6-19
▪ 6.3.4.2.5 Difficulty of moving	.....	6-19
▪ 6.3.4.2.6 Noninteraction with equipment not in need of maintenance	.....	6-19
<b>6.3.5 Labeling and marking</b>	.....	<b>6-19</b>
<b>6.3.5.1 Types of labels</b>	.....	<b>6-19</b>
▪ 6.3.5.1.1 Equipment identification	.....	6-19
▪ 6.3.5.1.2 Hazard labels	.....	6-20
▪ 6.3.5.1.3 Weight labels	.....	6-20
▪ 6.3.5.1.4 Instruction labels	.....	6-20
▪ 6.3.5.1.5 Data labels	.....	6-20
<b>6.3.5.2 Location and orientation</b>	.....	<b>6-20</b>
▪ 6.3.5.2.1 Readability	.....	6-20
▪ 6.3.5.2.2 Preserving readability	.....	6-20
□ 6.3.5.2.3 Consistent location	.....	6-20
▪ 6.3.5.2.4 Horizontal orientation	.....	6-20
<b>6.3.5.3 Typographic matters</b>	.....	<b>6-21</b>
▪ 6.3.5.3.1 Character height for viewing distance	.....	6-21
<b>Exhibit 6.3.5.3.1</b> Minimum character height for various viewing distances	.....	6-21
▪ 6.3.5.3.2 Stroke width in normal illumination	.....	6-21
▪ 6.3.5.3.3 Stroke width in dim illumination	.....	6-21
▪ 6.3.5.3.4 Width to height ratios	.....	6-21
▪ 6.3.5.3.5 Character spacing	.....	6-21
▪ 6.3.5.3.6 Word spacing	.....	6-21
▪ 6.3.5.3.7 Line spacing	.....	6-21
▪ 6.3.5.3.8 Case of letters	.....	6-21
▪ 6.3.5.3.9 Text and background combinations	.....	6-22
<b>6.3.5.4 Wording</b>	.....	<b>6-22</b>
▪ 6.3.5.4.1 Consistency	.....	6-22
□ 6.3.5.4.2 Wording	.....	6-22
□ 6.3.5.4.3 Instructions	.....	6-22

**6.3.5.5 Markings** ..... **6-22**

- **6.3.5.5.1** Number of color codes ..... 6-22
- **6.3.5.5.2** Recommended colors ..... 6-22
  - Exhibit 6.3.5.5.2** Recommended colors ..... 6-22
- **6.3.5.5.3** Arrows ..... 6-23
  - Exhibit 6.3.5.5.3** Good and bad arrows ..... 6-23

**6.4 Access openings** ..... **6-23**

**6.4.1 General** ..... **6-23**

- **6.4.1.1** When an access opening is required ..... 6-23
- **6.4.1.2** Number of openings ..... 6-23
- **6.4.1.3** Prevention of injury or damage ..... 6-23
- **6.4.1.4** Uncovered openings ..... 6-23
- **6.4.1.5** Unacceptability of rivets ..... 6-23

**6.4.2 Access** ..... **6-23**

- **6.4.2.1** Visual and physical access ..... 6-23
- **6.4.2.2** Visual access only ..... 6-24
- **6.4.2.3** Physical access only ..... 6-24

**6.4.3 Size** ..... **6-24**

- **6.4.3.1** Accommodation ..... 6-24
- **6.4.3.2** Dimensions for one- or two-finger access ..... 6-24
  - Exhibit 6.4.3.2** Minimum dimensions of openings designed for access by one or two fingers without visual access ..... 6-24
- **6.4.3.3** Dimensions for one hand or arm access ..... 6-25
  - Exhibit 6.4.3.3** Minimum dimensions of openings designed for access by one hand or arm without visual access ..... 6-25
- **6.4.3.4** Dimensions for two-hand access ..... 6-26
  - Exhibit 6.4.3.4** Minimum dimensions of openings designed for access by two hands without visual access ..... 6-26

**6.4.4 Shape** ..... **6-26**

- **6.4.4.1** Shape appropriate to task ..... 6-26

<b>6.4.5 Location</b>	.....	<b>6-26</b>
▪ 6.4.5.1 On accessible surfaces	.....	6-26
▪ 6.4.5.2 Near related displays, controls, and connectors	.....	6-27
▪ 6.4.5.3 Away from hazards	.....	6-27
▪ 6.4.5.4 Comfortable for maintainer	.....	6-27
□ 6.4.5.5 Easy removal of components	.....	6-27
▪ 6.4.5.6 Conformance with related items	.....	6-27
▪ 6.4.5.7 Free of obstructions	.....	6-27
▪ 6.4.5.8 Impervious to environmental conditions	.....	6-27
<b>6.4.6 Labeling and marking</b>	.....	<b>6-27</b>
▪ 6.4.6.1 Identification of opening	.....	6-27
□ 6.4.6.2 Identification of accessible components and maintenance tasks	.....	6-27
▪ 6.4.6.3 Warning labels	.....	6-27
▪ 6.4.6.4 Insertion holes	.....	6-27
<b>6.5 Covers, guards, and shields</b>	.....	<b>6-28</b>
<b>6.5.1 General</b>	.....	<b>6-28</b>
▪ 6.5.1.1 How to open	.....	6-28
□ 6.5.1.2 Ease of opening	.....	6-28
▪ 6.5.1.3 Fastened-unfastened indication	.....	6-28
▪ 6.5.1.4 Handles or grasp areas	.....	6-29
▪ 6.5.1.5 Shift in balance of equipment	.....	6-29
▪ 6.5.1.6 Stops and retaining devices	.....	6-29
▪ 6.5.1.7 Ventilation holes	.....	6-29
▪ 6.5.1.8 Rounded edges	.....	6-29
▪ 6.5.1.9 Small removable covers	.....	6-29
<b>6.5.2 Size</b>	.....	<b>6-29</b>
▪ 6.5.2.1 Size of covers	.....	6-29
<b>6.5.3 Shape</b>	.....	<b>6-30</b>
▪ 6.5.3.1 Appropriate to opening	.....	6-30
▪ 6.5.3.2 Proper orientation	.....	6-30
<b>6.5.4 Location</b>	.....	<b>6-30</b>
▪ 6.5.4.1 Accessible with equipment in installed position	.....	6-30
▪ 6.5.4.2 Noninterference of open cover with accessibility	.....	6-30
<b>6.5.5 Hinged covers</b>	.....	<b>6-30</b>
▪ 6.5.5.1 Safe operation	.....	6-30

▪ 6.5.5.2 Self-supporting .....	6-30
□ 6.5.5.3 Operable with one hand .....	6-30
<b>6.5.6 Sliding doors and caps</b> .....	<b>6-31</b>
▪ 6.5.6.1 Safe operation .....	6-31
□ 6.5.6.2 Positive locking .....	6-31
□ 6.5.6.3 Nonjamming .....	6-31
□ 6.5.6.4 Easy hand operation .....	6-31
<b>6.5.7 Preferred type of covering</b> .....	<b>6-31</b>
□ 6.5.7.1 Uncovered openings .....	6-31
▪ 6.5.7.2 Preferred type of cover .....	6-31
<b>Exhibit 6.5.7.2</b> Type of covering appropriate for type of access and environmental conditions .....	6-31
<b>6.5.8 Fasteners</b> .....	<b>6-32</b>
▪ 6.5.8.1 Fastener security .....	6-32
▪ 6.5.8.2 Number and ease of opening .....	6-32
▪ 6.5.8.3 Common fasteners .....	6-32
□ 6.5.8.4 Captive fasteners .....	6-32
□ 6.5.8.5 Quick-action fasteners .....	6-32
▪ 6.5.8.6 Self-alignment .....	6-32
▪ 6.5.8.7 Operable by hand or common hand tools .....	6-32
□ 6.5.8.8 Opened-closed indication .....	6-32
▪ 6.5.8.9 Hole size .....	6-32
▪ 6.5.8.10 Covers as structural members .....	6-32
□ 6.5.8.11 Pin-and-hook fasteners .....	6-33
<b>6.5.9 Interlocks</b> .....	<b>6-33</b>
▪ 6.5.9.1 Protection from hazards .....	6-33
▪ 6.5.9.2 Interlock override switch .....	6-33
▪ 6.5.9.3 Labeling covers with interlocks .....	6-33
<b>6.5.10 Labeling and marking</b> .....	<b>6-34</b>
▪ 6.5.10.1 Method of opening .....	6-34
▪ 6.5.10.2 Hazard labels .....	6-34
▪ 6.5.10.3 Instructional labels .....	6-34
<b>6.6 Cases</b> .....	<b>6-34</b>
<b>6.6.1 General</b> .....	<b>6-34</b>
▪ 6.6.1.1 Lift case, not equipment .....	6-34

▪ 6.6.1.2	Ease of removal and replacement .....	6-34
▪ 6.6.1.3	Accessibility .....	6-34
□ 6.6.1.4	Minimizing need for removal .....	6-34
▪ 6.6.1.5	Accessibility upon opening or removal .....	6-34
▪ 6.6.1.6	Handles or grips .....	6-35
▪ 6.6.1.7	Rounded edges .....	6-35
<b>6.6.2</b>	<b>Size .....</b>	<b>6-35</b>
▪ 6.6.2.1	Precise movements not required .....	6-35
▪ 6.6.2.2	Clearance between case and components .....	6-35
<b>6.6.3</b>	<b>Mounting .....</b>	<b>6-35</b>
▪ 6.6.3.1	Alignment aids .....	6-35
▪ 6.6.3.2	Sealing material .....	6-35
▪ 6.6.3.3	Stops and retainers .....	6-35
▪ 6.6.3.4	Supports .....	6-35
▪ 6.6.3.5	Fastened-unfastened indication .....	6-35
<b>6.6.4</b>	<b>Fasteners .....</b>	<b>6-36</b>
▪ 6.6.4.1	Fastener security .....	6-36
▪ 6.6.4.2	Number and ease of opening .....	6-36
▪ 6.6.4.3	Common fasteners .....	6-36
□ 6.6.4.4	Captive fasteners .....	6-36
□ 6.6.4.5	Quick-action fasteners .....	6-36
▪ 6.6.4.6	Self-alignment .....	6-36
▪ 6.6.4.7	Operable by hand or common hand tools .....	6-36
□ 6.6.4.8	Opened-closed indication .....	6-36
▪ 6.6.4.9	Hole size .....	6-36
<b>6.6.5</b>	<b>Interlocks .....</b>	<b>6-36</b>
▪ 6.6.5.1	Protection from hazards .....	6-37
▪ 6.6.5.2	Interlock override switch .....	6-37
▪ 6.6.5.3	Labeling cases with interlocks .....	6-37
<b>6.6.6</b>	<b>Labeling and marking .....</b>	<b>6-37</b>
▪ 6.6.6.1	Method of opening .....	6-37
▪ 6.6.6.2	Hazard labels .....	6-37
▪ 6.6.6.3	Instructional labels .....	6-37
<b>6.7</b>	<b>Fasteners .....</b>	<b>6-38</b>
<b>6.7.1</b>	<b>General .....</b>	<b>6-38</b>
▪ 6.7.1.1	Fastener security .....	6-38
▪ 6.7.1.2	Number and ease of opening .....	6-38
▪ 6.7.1.3	Common fasteners .....	6-38
▪ 6.7.1.4	Self-alignment .....	6-38
▪ 6.7.1.5	Operable by hand or common hand tools .....	6-38



□ 6.7.1.6 Open-closed indication .....	6-39
■ 6.7.1.7 Hole size .....	6-39
■ 6.7.1.8 Fastener variety .....	6-39
■ 6.7.1.9 When different fasteners are required .....	6-39
■ 6.7.1.10 Different fasteners must be distinguishable .....	6-39
■ 6.7.1.11 Location of fasteners .....	6-39
■ 6.7.1.12 Strength of hand-operated fasteners .....	6-40
■ 6.7.1.13 Painted or coated fasteners .....	6-40
□ 6.7.1.14 Precise torque requirements .....	6-40
■ 6.7.1.15 Torqued fasteners .....	6-40
<b>6.7.2 Number</b> .....	<b>6-40</b>
■ 6.7.2.1 Minimum that meets requirements .....	6-40
□ 6.7.2.2 Mounting .....	6-40
□ 6.7.2.3 Minimize by using hinges, catches, latches, and quick fastening and releasing devices .....	6-40
□ 6.7.2.4 Minimize by using tongue-and-slot design .....	6-40
<b>6.7.3 Types</b> .....	<b>6-40</b>
<b>6.7.3.1 Nuts and bolts</b> .....	<b>6-40</b>
■ 6.7.3.1.1 Bolt length .....	6-41
□ 6.7.3.1.2 Bolt threads .....	6-41
□ 6.7.3.1.3 Turns to tighten .....	6-41
■ 6.7.3.1.4 Hexagonal nuts .....	6-41
□ 6.7.3.1.5 Wing and knurled nuts .....	6-41
■ 6.7.3.1.6 Left-hand threads .....	6-41
■ 6.7.3.1.7 Lock washers .....	6-41
□ 6.7.3.1.8 Removal and replacement with one hand or tool ....	6-41
□ 6.7.3.1.9 Bolt mounting .....	6-41
<b>6.7.3.2 Screws</b> .....	<b>6-41</b>
□ 6.7.3.2.1 Number of turns .....	6-41
□ 6.7.3.2.2 Slot depth .....	6-41
■ 6.7.3.2.3 "Straight-in" screwdriver orientation .....	6-41
■ 6.7.3.2.4 Blind operation .....	6-42
□ 6.7.3.2.5 Screws for pressurized enclosures .....	6-42
□ 6.7.3.2.6 Countersunk screws .....	6-42
□ 6.7.3.2.7 Screws for thin panels .....	6-42
■ 6.7.3.2.8 Self-tapping screws .....	6-42
<b>6.7.3.3 Screw and bolt heads</b> .....	<b>6-42</b>
■ 6.7.3.3.1 Same heads for screws and bolts .....	6-42
□ 6.7.3.3.2 Combination-head bolts and screws .....	6-42
<b>Exhibit 6.7.3.3.2</b> Examples of combination- head bolts and screws .....	6-42
■ 6.7.3.3.3 Straight-slot and cross-recess type internal fasteners .....	6-42

■ 6.7.3.3.4 Internal-wrenching fasteners-where to use .....	6-43
<b>Exhibit 6.7.3.3.4</b> Example of an internal-wrenching bolt and nut .....	6-43
□ 6.7.3.3.5 Internal-wrenching fasteners - slots .....	6-43
■ 6.7.3.3.6 High-torque fasteners .....	6-43
□ 6.7.3.3.7 Low-torque fasteners .....	6-43
<b>6.7.3.4 Latches and catches</b> .....	<b>6-43</b>
■ 6.7.3.4.1 Positive catch .....	6-43
■ 6.7.3.4.2 Visual indication .....	6-43
□ 6.7.3.4.3 Spring-loading of catches .....	6-43
■ 6.7.3.4.4 Nonhazardous .....	6-43
■ 6.7.3.4.5 Associated handles .....	6-43
■ 6.7.3.4.6 Preventing inadvertent operation .....	6-44
<b>6.7.3.5 Other fastening devices</b> .....	<b>6-44</b>
■ 6.7.3.5.1 Integral fasteners not allowed .....	6-44
□ 6.7.3.5.2 Cotter pins and keys .....	6-44
■ 6.7.3.5.3 Retainer rings .....	6-44
□ 6.7.3.5.4 Pin-and-hook fasteners .....	6-44
■ 6.7.3.5.5 Safety wire .....	6-44
■ 6.7.3.5.6 Rivets .....	6-44
□ 6.7.3.5.7 Retainer chains .....	6-45
□ 6.7.3.5.8 Washers .....	6-45
<b>6.7.3.6 Quick fastening and releasing devices</b> .....	<b>6-45</b>
■ 6.7.3.6.1 Frequent access .....	6-46
■ 6.7.3.6.2 Tools not required .....	6-46
■ 6.7.3.6.3 Single motion .....	6-46
■ 6.7.3.6.4 Visual indication of state .....	6-46
■ 6.7.3.6.5 Minimum turns .....	6-46
<b>6.7.3.7 Captive versus removable</b> .....	<b>6-46</b>
■ 6.7.3.7.1 When to use .....	6-46
■ 6.7.3.7.2 Operation and replacement .....	6-46
■ 6.7.3.7.3 "Quarter-turn" fasteners .....	6-46
□ 6.7.3.7.4 Access covers .....	6-46
□ 6.7.3.7.5 Small removable pins, caps, and covers .....	6-46
□ 6.7.3.7.6 Mounting bolts .....	6-46
<b>6.7.4 Labeling, marking, and coding</b> .....	<b>6-47</b>
□ 6.7.4.1 Mounting bolts .....	6-47
□ 6.7.4.2 Fasteners requiring torquing .....	6-47

▪ 6.7.4.3 Durability of marking .....	6-47
▪ 6.7.4.4 Consistent coding .....	6-47
<b>6.8 Connectors</b> .....	<b>6-47</b>
<b>6.8.1 General</b> .....	<b>6-47</b>
▪ 6.8.1.1 Fast, easy operation .....	6-47
▪ 6.8.1.2 Safety .....	6-47
▪ 6.8.1.3 Hand or common tool operation .....	6-47
▪ 6.8.1.4 Compatibility .....	6-47
▪ 6.8.1.5 Protection of connectors .....	6-48
▪ 6.8.1.6 Captive covers .....	6-48
<b>6.8.2 Types</b> .....	<b>6-48</b>
<b>6.8.2.1 Distinctive</b> .....	<b>6-48</b>
▪ 6.8.2.1.1 Distinctive types .....	6-48
▪ 6.8.2.1.2 Preventing mismatching .....	6-48
<b>6.8.2.2 Plug-in</b> .....	<b>6-48</b>
□ 6.8.2.2.1 When to use .....	6-48
▪ 6.8.2.2.2 Preventing damage .....	6-48
<b>6.8.2.3 Threaded</b> .....	<b>6-48</b>
▪ 6.8.2.3.1 Ease of operation .....	6-48
<b>6.8.2.4 Quick-action</b> .....	<b>6-49</b>
<b>Exhibit 6.8.2.4</b> Example of a quick-action connector .....	6-49
▪ 6.8.2.4.1 When to use .....	6-49
▪ 6.8.2.4.2 Self-locking .....	6-49
<b>6.8.3 Location and accessibility</b> .....	<b>6-49</b>
▪ 6.8.3.1 Visual and physical access .....	6-49
▪ 6.8.3.2 Unobstructed access .....	6-49
▪ 6.8.3.3 Relative accessibility .....	6-49
▪ 6.8.3.4 Full access .....	6-49
▪ 6.8.3.5 Protected from dislodging and damage .....	6-49
▪ 6.8.3.6 Minimum spacing .....	6-49
▪ 6.8.3.7 Space for wrench .....	6-50
<b>6.8.4 Alignment aids</b> .....	<b>6-50</b>
▪ 6.8.4.1 Preventing misalignment .....	6-50
▪ 6.8.4.2 Alignment before contact .....	6-50



<b>6.8.6 Fluid and gas line connections</b>	.....	<b>6-54</b>
▪ 6.8.6.1 Connectors for rigid lines	.....	6-54
▪ 6.8.6.2 Draining and filling	.....	6-54
▪ 6.8.6.3 Leakage tests	.....	6-54
▪ 6.8.6.4 Control of leakage and spillage	.....	6-54
▪ 6.8.6.5 Exposure to noise and vibration	.....	6-54
<b>6.8.7 Gaskets and seals</b>	.....	<b>6-54</b>
▪ 6.8.7.1 Replaceable, renewable gaskets and seals	.....	6-54
▪ 6.8.7.2 Repair and replacement of gaskets and seals	.....	6-55
▪ 6.8.7.3 Identifiability of gaskets and seals	.....	6-55
▪ 6.8.7.4 Life expectancy of gaskets and seals	.....	6-55
▪ 6.8.7.5 Prevent entrance of air	.....	6-55
▪ 6.8.7.6 Tightening to offset shrinkage	.....	6-55
▪ 6.8.7.7 Visibility	.....	6-55
▪ 6.8.7.8 Nonprotrusion	.....	6-55
<b>6.8.8 Labeling, marking, and coding</b>	.....	<b>6-55</b>
▪ 6.8.8.1 Matching connectors or plugs and receptacles	.....	6-55
▪ 6.8.8.2 Noninterchangeable connectors	.....	6-55
▪ 6.8.8.3 Matching wires to terminal or pins	.....	6-56
▪ 6.8.8.4 Identification of terminals on terminal strips or blocks	.....	6-56
▪ 6.8.8.5 Visibility of codes and labels	.....	6-56
▪ 6.8.8.6 Location of labels and codes - connectors	.....	6-56
▪ 6.8.8.7 Location of labels and codes - receptacles	.....	6-56
▪ 6.8.8.8 Consistency of labels and codes	.....	6-56
▪ 6.8.8.9 Warnings and cautions	.....	6-56
▪ 6.8.8.10 Marking electrical connections	.....	6-56
▪ 6.8.8.11 Alignment coding	.....	6-56
<b>6.9 Lines and cables</b>	.....	<b>6-56</b>
<b>6.9.1 Electrical</b>	.....	<b>6-57</b>
<b>6.9.1.1 General</b>	.....	<b>6-57</b>
▪ 6.9.1.1.1 Selection	.....	6-57
□ 6.9.1.1.2 Insulation	.....	6-57
□ 6.9.1.1.3 Minimization	.....	6-57
▪ 6.9.1.1.4 Quick-acting connections	.....	6-57
▪ 6.9.1.1.5 Cable "fan out"	.....	6-57
□ 6.9.1.1.6 Preformed cables	.....	6-57
▪ 6.9.1.1.7 Harnesses	.....	6-58
▪ 6.9.1.1.8 Protection	.....	6-58
▪ 6.9.1.1.9 Exposed cables	.....	6-58
▪ 6.9.1.1.10 Special purpose cables	.....	6-58
▪ 6.9.1.1.11 Insect protection	.....	6-58

▪ 6.9.1.1.12 Fluid protection .....	6-58
▪ 6.9.1.1.13 Storage space .....	6-58
<b>Exhibit 6.9.1.1.13</b> Cable winders .....	6-58
▪ 6.9.1.1.14 Use of grommets .....	6-58
<b>6.9.1.2 Length of cables and leads</b> .....	<b>6-59</b>
□ 6.9.1.2.1 Length of cables .....	6-59
▪ 6.9.1.2.2 Extra cable .....	6-59
▪ 6.9.1.2.3 Accessibility .....	6-59
▪ 6.9.1.2.4 Cable length and connectors .....	6-59
▪ 6.9.1.2.5 Lead lengths .....	6-59
▪ 6.9.1.2.6 Slack .....	6-59
<b>Exhibit 6.9.1.2.6</b> Recoiling slack cable .....	6-60
<b>6.9.1.3 Routing and mounting</b> .....	<b>6-60</b>
▪ 6.9.1.3.1 Routing considerations .....	6-60
▪ 6.9.1.3.2 Combining lines .....	6-60
▪ 6.9.1.3.3 Segregate conductors .....	6-60
▪ 6.9.1.3.4 Routing over pipes .....	6-60
▪ 6.9.1.3.5 Lightly insulated wires .....	6-61
▪ 6.9.1.3.6 Protection .....	6-61
▪ 6.9.1.3.7 Visual and physical access .....	6-61
▪ 6.9.1.3.8 Unobstructed access .....	6-61
▪ 6.9.1.3.9 Replacement .....	6-61
▪ 6.9.1.3.10 Areas to avoid .....	6-61
▪ 6.9.1.3.11 Ease of maintenance .....	6-61
▪ 6.9.1.3.12 Nonobstruction .....	6-61
▪ 6.9.1.3.13 Remote switches .....	6-61
▪ 6.9.1.3.14 Cables within racks .....	6-61
▪ 6.9.1.3.15 Shortest route .....	6-61
<b>6.9.1.4 Leads</b> .....	<b>6-61</b>
▪ 6.9.1.4.1 No weight-bearing .....	6-61
▪ 6.9.1.4.2 Support .....	6-61
▪ 6.9.1.4.3 Orientation .....	6-62
▪ 6.9.1.4.4 No flexing .....	6-62
▪ 6.9.1.4.5 Signal checks .....	6-62
<b>6.9.1.5 Clamps and mounting plates</b> .....	<b>6-62</b>
▪ 6.9.1.5.1 Snug fit .....	6-62
▪ 6.9.1.5.2 Spacing .....	6-62
▪ 6.9.1.5.3 Special clamps .....	6-62
<b>Exhibit 6.9.1.5.3</b> Quick-release clamps, hinged and spring .....	6-62

	<ul style="list-style-type: none"> <li>■ 6.9.1.5.4 Placement ..... 6-62</li> <li>■ 6.9.1.5.5 Unsupported cable ..... 6-62</li> <li>■ 6.9.1.5.6 Visibility of clamps ..... 6-62</li> <li>■ 6.9.1.5.7 Mechanically-mounted clamps ..... 6-63</li> <li>■ 6.9.1.5.8 Nonconductive ..... 6-63</li> </ul>	
<b>6.9.1.6 Test and extension cables</b>	.....	<b>6-63</b>
	<ul style="list-style-type: none"> <li>■ 6.9.1.6.1 Easy access ..... 6-63</li> <li>□ 6.9.1.6.2 Multiple related functions ..... 6-63</li> <li>■ 6.9.1.6.3 Support equipment ..... 6-63</li> <li>■ 6.9.1.6.4 Noninterference ..... 6-63</li> <li>■ 6.9.1.6.5 Storage provisions ..... 6-63</li> <li>■ 6.9.1.6.6 Handling devices for cable ..... 6-63</li> </ul>	
	<b>Exhibit 6.9.1.6.6</b> Line and cable reel carts ..... 6-63	
	<ul style="list-style-type: none"> <li>□ 6.9.1.6.7 Automatic rewind ..... 6-63</li> <li>■ 6.9.1.6.8 Mobile support ..... 6-64</li> </ul>	
	<b>Exhibit 6.9.1.6.8</b> Line and cable mobile support ..... 6-64	
<b>6.9.1.7 Bench mockup cables</b>	.....	<b>6-64</b>
	<ul style="list-style-type: none"> <li>■ 6.9.1.7.1 Extension cables ..... 6-64</li> <li>■ 6.9.1.7.2 Connectors on mockup cables ..... 6-64</li> <li>■ 6.9.1.7.3 Coverings ..... 6-64</li> <li>■ 6.9.1.7.4 Checking signal flow ..... 6-64</li> </ul>	
<b>6.9.1.8 Labeling, marking, and coding</b>	.....	<b>6-64</b>
	<ul style="list-style-type: none"> <li>■ 6.9.1.8.1 Coding wire ..... 6-64</li> <li>■ 6.9.1.8.2 Identification ..... 6-64</li> <li>■ 6.9.1.8.3 Identification of terminals on terminal strips or blocks ..... 6-65</li> <li>■ 6.9.1.8.4 Methods of color coding ..... 6-65</li> </ul>	
	<b>Exhibit 6.9.1.8.4</b> Electrical cable coding ..... 6-65	
	<ul style="list-style-type: none"> <li>■ 6.9.1.8.5 Cables within a sheath ..... 6-65</li> <li>■ 6.9.1.8.6 Coding for orientation ..... 6-65</li> <li>■ 6.9.1.8.7 Color-coded values for fixed resistors and small capacitors ..... 6-65</li> </ul>	
	<b>Exhibit 6.9.1.8.7</b> Values for color-coded fixed resistors and small capacitors ..... 6-66	
<b>6.9.2 Fluid and gas lines</b>	.....	<b>6-66</b>
<b>6.9.2.1 General</b>	.....	<b>6-66</b>
	<ul style="list-style-type: none"> <li>□ 6.9.2.1.1 Use of flexible tubing ..... 6-66</li> </ul>	

□ 6.9.2.1.2 Use of flexible hose .....	6-66
■ 6.9.2.1.3 Visibility .....	6-66
<b>Exhibit 6.9.2.1.3</b> Externally visible seals .....	6-66
■ 6.9.2.1.4 Nonprotrusion .....	6-66
■ 6.9.2.1.5 Quick-action connectors .....	6-67
□ 6.9.2.1.6 Preventing leakage .....	6-67
■ 6.9.2.1.7 Standardized fittings .....	6-67
■ 6.9.2.1.8 Avoiding spraying fluids .....	6-67
■ 6.9.2.1.9 High-pressure lines .....	6-67
■ 6.9.2.1.10 Cutoff valves .....	6-67
■ 6.9.2.1.11 Avoiding drainage problems .....	6-67
<b>6.9.2.2 Routing and mounting</b> .....	<b>6-67</b>
■ 6.9.2.2.1 Accessibility .....	6-67
□ 6.9.2.2.2 Disconnecting .....	6-68
■ 6.9.2.2.3 Areas to avoid .....	6-68
■ 6.9.2.2.4 Fuel lines .....	6-68
■ 6.9.2.2.5 Heat resistant liners .....	6-68
□ 6.9.2.2.6 Avoiding line kinking .....	6-68
<b>6.9.2.3 Clamps and supports</b> .....	<b>6-68</b>
■ 6.9.2.3.1 External service supports .....	6-68
■ 6.9.2.3.2 Spring clamps .....	6-68
<b>6.9.2.4 Labeling, marking, and coding</b> .....	<b>6-68</b>
■ 6.9.2.4.1 Fluid conductor coding .....	6-68
<b>Exhibit 6.9.2.4.1</b> Color coding of fluid conductors .....	6-69
■ 6.9.2.4.2 Valve color coding .....	6-69
<b>Exhibit 6.9.2.4.2</b> Valve color coding scheme .....	6-69
■ 6.9.2.4.3 Hydraulic and pneumatic line coding .....	6-70
<b>Exhibit 6.9.2.4.3</b> Hydraulic and pneumatic color coding scheme .....	6-70
■ 6.9.2.4.4 Label contents .....	6-70
■ 6.9.2.4.5 Valve position labeling .....	6-70
<b>Exhibit 6.9.2.4.5</b> Valve position labeling .....	6-70



<b>6.10 Packaging, layout, and mounting of internal components</b>	6-71
<b>6.10.1 General</b>	6-71
▪ 6.10.1.1 Accessibility	6-71
▪ 6.10.1.2 Minimize tool requirements	6-71
□ 6.10.1.3 Minimize maintainer movement	6-71
□ 6.10.1.4 Organized by maintenance specialty	6-71
<b>6.10.2 Packaging</b>	6-71
<b>6.10.2.1 Modularization</b>	6-72
□ 6.10.2.1.1 Modularization	6-72
▪ 6.10.2.1.2 Single function	6-72
▪ 6.10.2.1.3 Physical and functional interchangeability	6-72
▪ 6.10.2.1.4 Distinguishability of noninterchangeable modules	6-72
□ 6.10.2.1.5 Unreliable components	6-72
▪ 6.10.2.1.6 Maintenance in installed location	6-72
▪ 6.10.2.1.7 Testing	6-72
<b>6.10.2.2 Modularization methods</b>	6-72
□ 6.10.2.2.1 Modularization method	6-72
▪ 6.10.2.2.2 Logical flow packaging	6-73
▪ 6.10.2.2.3 Circuit packaging	6-73
□ 6.10.2.2.4 Component packaging	6-73
▪ 6.10.2.2.5 Printed circuit boards	6-73
<b>6.10.3 Layout</b>	6-74
<b>6.10.3.1 Accessibility</b>	6-74
▪ 6.10.3.1.1 No interference from other parts	6-74
▪ 6.10.3.1.2 No stacking of parts	6-74
□ 6.10.3.1.3 Consistent orientation	6-74
▪ 6.10.3.1.4 Spacing of parts	6-74
▪ 6.10.3.1.5 Separation of parts and wiring on printed circuit boards	6-74
▪ 6.10.3.1.6 Spacing of terminals	6-74
▪ 6.10.3.1.7 Frequently inspected component parts	6-74
▪ 6.10.3.1.8 High failure-rate parts	6-74
□ 6.10.3.1.9 Indicator lights	6-74
▪ 6.10.3.1.10 Shutoff switches	6-75
▪ 6.10.3.1.11 Visual and physical accessibility	6-75

<b>6.10.3.2 Grouping of parts</b>	.....	<b>6-75</b>
▪ 6.10.3.2.1 Grouping maintenance displays	.....	6-75
□ 6.10.3.2.2 Separating maintenance and operational displays	.....	6-75
<b>6.10.3.3 Hazard protection</b>	.....	<b>6-75</b>
▪ 6.10.3.3.1 Avoidance of damage to parts and wiring	.....	6-75
▪ 6.10.3.3.2 Avoidance of damage from handling	.....	6-75
▪ 6.10.3.3.3 Avoidance of damage from the environment	.....	6-75
▪ 6.10.3.3.4 Protecting maintainers from heat and electrical shock	.....	6-75
▪ 6.10.3.3.5 Bleeder networks	.....	6-75
▪ 6.10.3.3.6 Separating internal controls from hazardous voltages	.....	6-75
▪ 6.10.3.3.7 High current switching devices	.....	6-76
<b>6.10.4 Mounting</b>	.....	<b>6-76</b>
□ 6.10.4.1 Foldout mounting	.....	6-76
<b>Exhibit 6.10.4.1</b> Example of foldout mounting construction	.....	6-76
▪ 6.10.4.2 Prevention of damage with foldout mounting	.....	6-76
▪ 6.10.4.3 Support for hinged mounting	.....	6-76
▪ 6.10.4.4 Rests and stands	.....	6-76
□ 6.10.4.5 Straps and brackets - characteristics	.....	6-76
□ 6.10.4.6 Shock mounts	.....	6-76
▪ 6.10.4.7 Preventing mounting errors by physical design	.....	6-77
<b>Exhibit 6.10.4.7</b> Error-free mounting provisions	.....	6-77
▪ 6.10.4.8 Mounting and orientation of similar items	.....	6-77
▪ 6.10.4.9 Accessibility	.....	6-77
▪ 6.10.4.10 Controls	.....	6-77
▪ 6.10.4.11 Common hand tools	.....	6-77
□ 6.10.4.12 Front access	.....	6-77
▪ 6.10.4.13 Orientation of modules within cases	.....	6-77
▪ 6.10.4.14 "Plug-in" connectors	.....	6-77
<b>6.10.5 Labeling and marking</b>	.....	<b>6-78</b>
▪ 6.10.5.1 When to use labels and markings	.....	6-78
▪ 6.10.5.2 Location of labels and markings - consistency	.....	6-78
□ 6.10.5.3 Location of labels and markings - eye level	.....	6-78
▪ 6.10.5.4 Visibility	.....	6-78
▪ 6.10.5.5 Orientation	.....	6-78
▪ 6.10.5.6 Electrical parts	.....	6-78
▪ 6.10.5.7 Parts requiring identification	.....	6-78

- 6.10.5.8 Identification of terminals on terminal strips or blocks ..... 6-79
- 6.10.5.9 Identification of terminals on parts ..... 6-79
- 6.10.5.10 Identification of parts accessible from both sides .... 6-79
- 6.10.5.11 Adequacy of markings ..... 6-79
- 6.10.5.12 Durability of markings ..... 6-79
- 6.10.5.13 Marking stacked parts ..... 6-79
- 6.10.5.14 Marking enclosed parts ..... 6-79
- 6.10.5.15 Designation of parts ..... 6-79
- 6.10.5.16 Hazard warnings ..... 6-79
- 6.10.5.17 Labeling symmetric parts ..... 6-79
- 6.10.5.18 Insertion holes ..... 6-79
- 6.10.5.19 Auxiliary information for parts ..... 6-79

**6.11 Adjustment controls** ..... **6-80**

- 6.11.1 Controls and feedback ..... 6-80
- 6.11.2 Simultaneous access to controls and displays ..... 6-80
- 6.11.3 Location of adjustment controls ..... 6-80
- 6.11.4 Differentiating maintenance controls from operational controls ..... 6-80
- 6.11.5 Independence of adjustment controls ..... 6-80
- 6.11.6 Sequential adjustments ..... 6-80
- 6.11.7 Functionally related adjustments ..... 6-80
- 6.11.8 Direct readings ..... 6-80
- 6.11.9 Knob adjustments preferred to screwdriver adjustments ..... 6-80
- 6.11.10 Screwdriver adjustments - preventing slipping ..... 6-81
- 6.11.11 Screwdriver guides ..... 6-81
- 6.11.12 Use of mirrors or flashlights ..... 6-81
- 6.11.13 Remote adjustments ..... 6-81
- 6.11.14 Degree of adjustment ..... 6-81
- 6.11.15 Mechanical stops ..... 6-81
- 6.11.16 Previous settings ..... 6-81
- 6.11.17 Preventing inadvertent adjustment ..... 6-81
- 6.11.18 Critical or sensitive adjustments ..... 6-81
- 6.11.19 Hand or arm support ..... 6-81
- 6.11.20 Avoidance of hazards ..... 6-81

**6.12 Failure detection and isolation** ..... **6-81**

**6.12.1 Alarms** ..... **6-82**

- 6.12.1.1 When to use ..... 6-82
- 6.12.1.2 Visual versus auditory alarm ..... 6-82
- 6.12.1.3 Special alarm ..... 6-82
- 6.12.1.4 Loss of redundancy ..... 6-82

<b>6.12.2 Failure indicators</b>	.....	<b>6-82</b>
▪ 6.12.2.1 Overload indicators	.....	6-82
▪ 6.12.2.2 Out of range indicators	.....	6-82
▪ 6.12.2.3 Power failure indicators	.....	6-82
▪ 6.12.2.4 Open circuit indicators	.....	6-82
▪ 6.12.2.5 Power-on indicator	.....	6-82
<b>6.12.3 Diagnostic aids</b>	.....	<b>6-82</b>
▪ 6.12.3.1 Automated aids	.....	6-82
▪ 6.12.3.2 Automatic self-checking components	.....	6-82
▪ 6.12.3.3 On-demand system check	.....	6-83
▪ 6.12.3.4 Fault detection	.....	6-83
▪ 6.12.3.5 Identification	.....	6-83
▪ 6.12.3.6 Sensor verification	.....	6-83
▪ 6.12.3.7 Equipment verification	.....	6-83
▪ 6.12.3.8 Fault detection without disassembly	.....	6-83
▪ 6.12.3.9 Portable diagnostic tools	.....	6-83
<b>6.13 Fuses and circuit breakers</b>	.....	<b>6-83</b>
<b>6.13.1 General</b>	.....	<b>6-83</b>
□ 6.13.1.1 Selection of fuses and circuit breakers	.....	6-83
<b>Exhibit 6.13.1.1</b> General comparison of fuses and circuit breakers	.....	6-84
▪ 6.13.1.2 Location of fuses and circuit breakers	.....	6-84
▪ 6.13.1.3 Verification of an open circuit	.....	6-84
□ 6.13.1.4 Individual fused units	.....	6-84
<b>6.13.2 Fuses</b>	.....	<b>6-84</b>
▪ 6.13.2.1 Using fuses	.....	6-84
▪ 6.13.2.2 Worker safety	.....	6-84
▪ 6.13.2.3 Safeguarding the circuit	.....	6-84
□ 6.13.2.4 Quick-disconnect fuse holders	.....	6-84
▪ 6.13.2.5 No special tools for fuse replacement	.....	6-85
▪ 6.13.2.6 No other components to be removed	.....	6-85
▪ 6.13.2.7 Spare fuse provisions	.....	6-85
□ 6.13.2.8 Anticorrosion precautions	.....	6-85
<b>6.13.3 Push-pull circuit breakers</b>	.....	<b>6-85</b>
▪ 6.13.3.1 Push-pull circuit breaker specifications	.....	6-85
<b>Exhibit 6.13.3.1</b> Push-pull circuit breaker specifications	....	6-86

	▪ 6.13.3.2 Power switches .....	6-85
<b>6.13.4 Toggle bat and legend switch circuit breakers</b>	.....	<b>6-86</b>
	▪ 6.13.4.1 Toggle bat specifications .....	6-86
	<b>Exhibit 6.13.4.1</b> Toggle bat specifications .....	6-87
	▪ 6.13.4.2 Legend switch specifications .....	6-88
	<b>Exhibit 6.13.4.2</b> Legend switch specifications .....	6-88
<b>6.13.5 Labeling and marking</b>	.....	<b>6-88</b>
	▪ 6.13.5.1 Fuses and circuit breakers .....	6-88
	▪ 6.13.5.2 Fuse ratings .....	6-88
	▪ 6.13.5.3 Circuits .....	6-89
<b>6.14 Test points and service points</b>	.....	<b>6-89</b>
<b>6.14.1 Adjustment controls</b>	.....	<b>6-89</b>
	▪ 6.14.1.1 Location .....	6-89
	□ 6.14.1.2 Individual adjustment controls .....	6-89
<b>6.14.2 Location and arrangement</b>	.....	<b>6-89</b>
	□ 6.14.2.1 Test points for units of equipment .....	6-89
	▪ 6.14.2.2 Arranging test points .....	6-89
	□ 6.14.2.3 Tracing signals .....	6-89
	▪ 6.14.2.4 Test and service point accessibility .....	6-89
	▪ 6.14.2.5 Proximity to associated controls and displays .....	6-89
	□ 6.14.2.6 Test and service point location .....	6-89
	□ 6.14.2.7 Minimizing testing and servicing .....	6-90
	▪ 6.14.2.8 Minimizing test and service points .....	6-90
	□ 6.14.2.9 Avoid isolated test or service points .....	6-90
	▪ 6.14.2.10 Compatibility of test and service points .....	6-90
	□ 6.14.2.11 Distinctive connections .....	6-90
	□ 6.14.2.12 Avoid separate accessories .....	6-90
	□ 6.14.2.13 Terminal strips .....	6-90
	<b>Exhibit 6.14.2.13</b> Terminal strips .....	6-90

<b>6.14.3 Drain points</b>	.....	<b>6-90</b>
▪ 6.14.3.1 Drain provisions	.....	6-90
□ 6.14.3.2 Minimization	.....	6-90
□ 6.14.3.3 Valves and petcocks versus drain plugs	.....	6-91
▪ 6.14.3.4 Drain plugs	.....	6-91
▪ 6.14.3.5 Labels	.....	6-91
▪ 6.14.3.6 Drain cock motions	.....	6-91
▪ 6.14.3.7 Instruction labels	.....	6-91
▪ 6.14.3.8 Accessibility	.....	6-91
<b>6.14.4 Accessibility</b>	.....	<b>6-91</b>
▪ 6.14.4.1 Test and service point accessibility	.....	6-91
□ 6.14.4.2 Test probe guides	.....	6-91
□ 6.14.4.3 Test accesses	.....	6-91
▪ 6.14.4.4 Test points in plugs	.....	6-92
Exhibit 6.14.4.4 (a) Test plug with sliding cover	.....	6-92
Exhibit 6.14.4.4 (b) Test point adapter	.....	6-92
<b>6.14.5 Safety</b>	.....	<b>6-92</b>
▪ 6.14.5.1 Test point shielding	.....	6-92
▪ 6.14.5.2 Minimum clearance	.....	6-92
□ 6.14.5.3 Recessed test and service points	.....	6-92
□ 6.14.5.4 High pressure test indicators	.....	6-92
▪ 6.14.5.5 Ground points	.....	6-92
□ 6.14.5.6 Shields around lubrication points	.....	6-92
<b>6.14.6 Labeling, marking, and coding</b>	.....	<b>6-93</b>
▪ 6.14.6.1 Label location	.....	6-93
▪ 6.14.6.2 Distinguishable marking	.....	6-93
▪ 6.14.6.3 Distinguishing test and service points	.....	6-93
▪ 6.14.6.4 Hazardous points	.....	6-93
▪ 6.14.6.5 Identification of test points	.....	6-93
□ 6.14.6.6 Luminescent markings	.....	6-93
□ 6.14.6.7 Tolerance limits	.....	6-93
▪ 6.14.6.8 Internal test and service points	.....	6-93
<b>6.15 Test equipment</b>	.....	<b>6-93</b>
<b>6.15.1 General</b>	.....	<b>6-94</b>
<b>6.15.1.1 General characteristics</b>	.....	<b>6-94</b>
▪ 6.15.1.1.1 Test equipment treatment	.....	6-94
▪ 6.15.1.1.2 Accuracy of test equipment	.....	6-94
▪ 6.15.1.1.3 Conversion tables	.....	6-94

□ 6.15.1.1.4 Selector switches .....	6-94
■ 6.15.1.1.5 Maintenance instructions .....	6-94
■ 6.15.1.1.6 Storing instructions .....	6-94
□ 6.15.1.1.7 Labeling .....	6-94
■ 6.15.1.1.8 Label contents .....	6-94
<b>6.15.1.2 Safety .....</b>	<b>6-94</b>
■ 6.15.1.2.1 Shielding hazardous parts .....	6-94
■ 6.15.1.2.2 Safeguarding the circuit .....	6-95
□ 6.15.1.2.3 Covering exposed parts .....	6-95
■ 6.15.1.2.4 Warning of errors .....	6-95
□ 6.15.1.2.5 Minimizing hazards .....	6-95
■ 6.15.1.2.6 Internal controls .....	6-95
■ 6.15.1.2.7 Safeguarding high voltages .....	6-95
■ 6.15.1.2.8 Warning labels .....	6-95
<b>6.15.1.3 Ease of use .....</b>	<b>6-95</b>
■ 6.15.1.3.1 Accessibility .....	6-95
□ 6.15.1.3.2 Minimizing test equipment .....	6-95
□ 6.15.1.3.3 Ease of use .....	6-95
□ 6.15.1.3.4 Reducing the number of steps .....	6-95
□ 6.15.1.3.5 Individual operation .....	6-95
<b>6.15.1.4 Controls and displays .....</b>	<b>6-95</b>
□ 6.15.1.4.1 Calibration check .....	6-95
□ 6.15.1.4.2 Warm-up indicators .....	6-96
□ 6.15.1.4.3 Automatic shutoff switches .....	6-96
□ 6.15.1.4.4 Misalignment .....	6-96
<b>6.15.2 Built-in test equipment (including partially built-in, portable, and test panels) .....</b>	<b>6-96</b>
<b>6.15.2.1 Completely built-in test equipment .....</b>	<b>6-96</b>
□ 6.15.2.1.1 Combining test points .....	6-96
□ 6.15.2.1.2 Efficiency .....	6-96
□ 6.15.2.1.3 Easy to use .....	6-97
□ 6.15.2.1.4 In-tolerance .....	6-97
<b>6.15.2.2 Partially built-in test equipment .....</b>	<b>6-97</b>
□ 6.15.2.2.1 Combining test points .....	6-97
□ 6.15.2.2.2 Test capabilities .....	6-97

<b>6.15.2.3 Portable test equipment</b>	.....	<b>6-97</b>
▪ 6.15.2.3.1 When to use	.....	6-97
▪ 6.15.2.3.2 Single connection	.....	6-97
▪ 6.15.2.3.3 Internal storage	.....	6-97
▪ 6.15.2.3.4 Operating instructions	.....	6-97
▪ 6.15.2.3.5 Calibration records	.....	6-97
<b>6.15.2.4 Built-in test panel</b>	.....	<b>6-98</b>
□ 6.15.2.4.1 When to use	.....	6-98
▪ 6.15.2.4.2 Test point connections	.....	6-98
□ 6.15.2.4.3 Block diagram	.....	6-98
□ 6.15.2.4.4 Overlays	.....	6-98
□ 6.15.2.4.5 Tolerance limits for signals	.....	6-98
<b>6.15.3 Go, no-go test equipment</b>	.....	<b>6-98</b>
<b>6.15.4 Automatic test equipment</b>	.....	<b>6-98</b>
<b>6.15.5 Collating test equipment</b>	.....	<b>6-99</b>
□ 6.15.5.1 Identification of out-of-tolerance signals	.....	6-99
<b>6.15.6 Bench mockups</b>	.....	<b>6-99</b>
▪ 6.15.6.1 Accessibility	.....	6-99
▪ 6.15.6.2 Support for test equipment	.....	6-99
▪ 6.15.6.3 Extension cables	.....	6-99
▪ 6.15.6.4 Connectors on mockup cables	.....	6-99
▪ 6.15.6.5 Coverings	.....	6-99
▪ 6.15.6.6 Checking signal flow	.....	6-99
□ 6.15.6.7 Test leads	.....	6-100
▪ 6.15.6.8 Signal values	.....	6-100
□ 6.15.6.9 Covers	.....	6-100
▪ 6.15.6.10 Easy access	.....	6-100
<b>6.15.7 Storage space</b>	.....	<b>6-100</b>
▪ 6.15.7.1 Available storage	.....	6-100
▪ 6.15.7.2 Securing accessories	.....	6-100
▪ 6.15.7.3 Labeling	.....	6-100
▪ 6.15.7.4 Handles	.....	6-100



<b>6.16 Tools</b>	.....	<b>6-100</b>
<b>6.16.1 General</b>	.....	<b>6-100</b>
▪ 6.16.1.1 Minimize maintenance tools	.....	6-100
▪ 6.16.1.2 Use common tools	.....	6-101
▪ 6.16.1.3 Minimize variety and sizes of tools required	.....	6-101
▪ 6.16.1.4 Special tools	.....	6-101
<b>6.16.2 Common hand tools</b>	.....	<b>6-101</b>
▪ 6.16.2.1 Gripping surfaces	.....	6-101
□ 6.16.2.2 Providing thongs	.....	6-101
▪ 6.16.2.3 Insulation of handles	.....	6-101
<b>6.16.3 Special tools</b>	.....	<b>6-101</b>
▪ 6.16.3.1 Reasons for requiring special tools	.....	6-101
□ 6.16.3.2 Check for existing tools	.....	6-101
▪ 6.16.3.3 Availability of special tools	.....	6-101
□ 6.16.3.4 Attach to equipment	.....	6-101
□ 6.16.3.5 Temperature extremes	.....	6-101
▪ 6.16.3.6 Spark resistance	.....	6-102



## 6 Designing equipment for maintenance

This section contains human factors criteria and guidelines intended to make equipment maintenance easy, fast, and safe. The topics include: (1) general criteria and guidelines, (2) designing equipment for handling, (3) packaging, arrangement, and mounting of equipment, (4) access openings, (5) covers and shields, (6) cases, (7) fasteners, (8) connectors, (9) lines and cables, (10) packaging, layout, and mounting of internal components, (11) adjustment controls, (12) failure detection and isolation, (13) fuses and circuit breakers, (14) test points and service points, (15) test equipment, and (16) tools.

Equipment maintenance does not, of course, occur in isolation. The overall system of which the equipment is a part affects the design of the equipment; for example, if the system must run continuously, the equipment might be designed to allow maintenance while it is in operation, or some sort of redundancy might be provided. The system maintenance concept also affects equipment design; for example, is a particular unit of equipment intended to be repaired on site? Is it intended to be removed and repaired at another location? Or is it intended to be discarded and replaced with another unit? A third factor affecting equipment design is the physical environment in which it will be located; will it be exposed to weather or to temperature extremes? Will the maintainer be wearing gloves or other protective clothing? Finally, equipment must accommodate characteristics of the maintainers themselves, their sizes and shapes, their skills, and their training.

### 6.1 General

This section contains criteria and guidelines for: (1) designing equipment in general, (2) emphasizing maintenance during the design of equipment, modules, and components, (3) maximizing the use of existing equipment and tools, (4) minimizing the skill and training requirements for maintainers, and (5) minimizing the need for maintenance.

#### 6.1.1 General design guidance

One of the most important aspects of designing equipment for maintenance is the breaking up of a unit of equipment into modules that are independent, interchangeable, and easily replaced. If warranted, these modules can also be disposable. Other important aspects are: ease of access to test and service points, ease of access to internal parts and components, and, if warranted, built-in testing, diagnostic and fault localization capability.

**Definitions.** A **unit of equipment** is an assemblage of items that may include modules, components, and parts that are packaged together into a single hardware package. For example, a computer, its keyboard, and its visual display are all units of equipment, as are radio transmitters and receivers. A **module** is an assemblage of two or more interconnected parts or components that

comprise a single, physical and functional entity. It is this singular functionality that defines a module. A **component** is a subdivision of a unit of equipment that can be treated as an object by the maintainer, but which can be further broken down into parts. A mounting board together with its mounted parts is an example of a component. A **part** is an object that cannot normally be broken down further without destroying its designated use. Fuses, resistors, and capacitors are examples of parts.

- **6.1.1.1 General design guidance.** The following features should be incorporated into the design of all equipment, modules, and components, as appropriate:
  - a. simplification of maintenance functions,
  - b. modularization of equipment and components,
  - c. minimization of the number and complexity of maintenance tasks,
  - d. use of built-in testing, diagnostic, and fault localization capabilities,
  - e. use of disposable modules, components, and parts, where cost effective and appropriate,
  - f. simplification of design,
  - g. quick and easy access to all units of equipment, modules, components and parts that require maintenance, inspection, removal, or replacement,
  - h. compliance with lifting, carrying, and force criteria and guidelines,
  - i. minimization of the numbers and types of tools and test equipment required for maintenance,
  - j. design alternatives dependent on the skills and training needed by maintainers and operators,
  - k. maximization of the safety and protection of maintainers and equipment,
  - l. ease of assembly, disassembly, installation, and removal,
  - m. elimination of precise torque requirements,
  - n. ability to perform maintenance from above and outside rather than from underneath and inside,
  - o. use of self lubrication, and
  - p. use of sealed and lubricated modules.

### 6.1.2 Emphasizing maintenance during design

- **6.1.2.1 Noninterruption of continuous operation.** Equipment that is part of a system that must operate continuously shall be capable of undergoing maintenance without interrupting the operation.
- **6.1.2.2 Redundancy to prevent interruption.** If continuous operation is required and required maintenance on a unit of equipment would interrupt the operation, redundant equipment shall be provided.
- **6.1.2.3 Degraded operation.** When warranted by its importance in a system, a unit of equipment that has a partial failure shall be designed to operate in a degraded mode while awaiting maintenance. This degraded operation shall not cause damage to other equipment or components, nor shall it aggravate the original fault. Degraded operation and faults shall be sensed and appropriate information identified, displayed, or transmitted to maintainers and, if appropriate, to operators.
- **6.1.2.4 Automation of fault detection and isolation.** When warranted, equipment shall have automatic fault detection and isolation capability.
- **6.1.2.5 Equipment independence for maintenance.** Units of equipment shall be as independent (functionally, mechanically, electrically, and electronically) as is practical (see paragraph 6.3.1.1).
- **6.1.2.6 Designing for safety of maintainers.** Equipment shall not present hazardous conditions to maintainers as they perform maintenance procedures. A positive means (for example, disconnects or lockouts) shall be designed into equipment and used to control hazardous conditions and facilitate safety as outlined in 29 CFR 1910.147.

**Definitions.** A **hazardous condition** is the presence of energy or a substance which is likely to cause death or injury by reason of physical force, shock, radiation, explosion, flames, poison, corrosion, oxidation, irritation or other debilitation. Biological and chemical hazards can have debilitating effects through disease or interference with physiological functions. A **hazardous location** is a space within a facility, room, or open environment where a hazardous condition exists or is accessible or exposed within the system or equipment located within the space.

- **6.1.2.7 Dividing equipment into modules.** Heavy, large, or complex equipment should be divided into modules.

**Discussion.** Modularization of equipment can make it easier to: (1) locate and isolate malfunctions, (2) properly

allocate maintenance functions and responsibilities, (3) reach, remove, and maintain components, and (4) handle the equipment for installation and repair.

- **6.1.2.8 Controls and displays for maintenance.** Controls and displays for maintenance shall comply with the criteria and guidelines in section 7, Human-equipment interfaces.
- **6.1.2.9 Replacement of failed components.** Equipment shall be designed so that components that fail frequently (such as lamps and fuses) can be easily replaced.

### 6.1.3 Use of existing or common equipment and tools

- **6.1.3.1 Use of existing items.** If an existing unit of equipment, module, component, or part meets the relevant requirements and the applicable human engineering criteria in this document, designers shall use that existing item rather than design a new one.

**Discussion.** Relevant requirements include performance, maintainability, and reliability criteria designated by the acquisition program office.

**Definition. Item** is a nonspecific term used to denote any product, available or in design or development, including parts, components, modules, and units of equipment.

- **6.1.3.2 Interchangeability of items.** Units of equipment shall be designed to maximize the interchangeability of modules, components, and parts (see paragraph 6.3.2.1).
- **6.1.3.3 Noninterchangeable items.** Items (units of equipment or modules) that are similar in size and shape to other items but different from them in functional properties, shall be easily identifiable and distinguishable. In addition, they shall not be physically interchangeable (see paragraph 6.3.2.3).
- **6.1.3.4 Minimize maintenance equipment and tools.** Units of equipment shall be designed to minimize the numbers and types of auxiliary equipment and tools required to accomplish maintenance tasks.
- **6.1.3.5 Use common test equipment and tools.** Whenever possible, systems and units of equipment shall be designed so that maintenance can be accomplished with common test equipment and tools.
- **6.1.3.6 Special tools.** Uncommon or specially-designed tools shall be used only when common hand tools do not satisfy the requirements or when the special tools provide a significant advantage over common hand tools. Special tools shall not be

required or used without approval by the acquisition program office (same as paragraph 6.16.1.4).

### 6.1.4 Optimize skills and training

- **6.1.4.1 Optimize balance between use, maintenance, and special skills.** As practical, optimize the balance between ease of use, maintenance, and the need for special skills on the part of the maintainers.
- **6.1.4.2 Optimize balance between ease of use and training.** As practical, optimize the balance between ease of use and training on the part of the maintainers. Special training shall only be required when equipment or automation is implemented or has undergone major modification.

### 6.1.5 Minimizing need for maintenance

- **6.1.5.1 Ease of servicing.** Equipment shall be designed so that it can be serviced in its installed position.
- **6.1.5.2 Minimize maintenance time.** Equipment shall be designed to minimize the time required for maintenance.

## 6.2 Designing equipment for handling

The purpose in designing equipment for handling is to increase the efficiency of the maintainer and to reduce the likelihood of injury to the maintainer or damage to the equipment. The topics covered in this section include (1) the weight, size, and shape of the equipment, (2) the provision of handles and grasp areas, (3) the provision of stands, rests, and alignment aids, (4) designing for remote handling, and (5) designing for the use of hoists, jacks, and cranes.

### 6.2.1 General

- **6.2.1.1 Maintainer efficiency and safety.** Units of equipment shall be designed, located, and protected so that they maximize the efficiency of the maintainer and minimize the likelihood of injury to the maintainer and damage to the equipment. (See paragraph 12.4.1.18 for safety aspects of electrical utilization equipment as required by OSHA.)
- **6.2.1.2 Prevention of damage.** Units of equipment shall be designed, located, and protected so that they will not be damaged when they are stored, shipped, handled, installed, operated, or maintained. Susceptibility to damage shall be clearly identified. Procedural guidance and suitable warning labels shall be provided to help prevent such damage.
- **6.2.1.3 Minimal number of maintainers.** Units of equipment shall be designed, placed, and mounted so that they can be

installed and removed by a minimum number of people wearing clothing appropriate to the environment.

## 6.2.2 Weight

The weight limits provided in this section assume that they will be lifted by able-bodied people not by those covered by the Americans with Disabilities Act.

- **6.2.2.1 Maximum weight of units of equipment to be lifted by one person.** If a unit of equipment is designed to be lifted by a single person, its weight shall not exceed the value in exhibit 6.2.2.1 that is appropriate for the height to which it is to be lifted and the size of the unit as it affects the distance between the body and the grip.

**Exhibit 6.2.2.1** Maximum weight limits for objects lifted by one person using both hands; data are for a male or female

Height to which lifted	Distance between body and grip			
	150 mm (6 in)	300 mm (12 in)	460 mm (18 in)	610 mm (24 in)
.9 m (3 ft)	20.2 kg (44 lb)	13.3 kg (29.3 lb)	10.1 kg (22 lb)	6.6 kg (14.7 lb)
1.5 m (5 ft)	16.8 kg (37 lb)	11.2 kg (24.7 lb)	8.4 kg (18.5 lb)	5.6 kg (12.3 lb)

- **6.2.2.2 Lifting in the presence of obstacles.** The values given in exhibit 6.2.2.1 assume that there are no obstacles between the person lifting and the surface onto which the object is to be placed. If there is an obstacle, such as a lower shelf, the weight limit shall be reduced by 33 percent for an obstacle protruding 300 mm (12 in), 50 percent for an obstacle protruding 460 mm (18 in), and 66 percent for an obstacle protruding 610 mm (24 in). No lift shall be performed at a reach distance greater than 635 mm (25 in). If the allowable weight must be reduced by both size (distance between body and grip) and obstacle considerations, only the more restrictive single value shall apply, that is, two reductions shall not be applied.
- **6.2.2.3 Maximum weight of units of equipment to be lifted by two people.** If a unit of equipment is designed to be lifted by two people, the weight lifted by either one of them shall not exceed the appropriate value given in exhibit 6.2.2.1; thus, if the weight of the unit is distributed uniformly, the maximum weight is twice that for a single person.
- **6.2.2.4 Maximum weight of units of equipment to be lifted by three or more people.** If a unit of equipment is designed to be lifted by three or more people, the weight lifted by any one of them shall not exceed the appropriate value given in exhibit 6.2.2.1. The maximum weight of the unit may be increased by three-fourths of the single person value for each person in addition to the first. Thus the maximum weight shall not exceed

$$X + 0.75(N-1)X$$



where X is the appropriate value from exhibit 6.2.2.1, and N is the number of people lifting. This increase assumes that the unit is large enough that the people lifting do not interfere with each other.

- **6.2.2.5 Maximum weight of units of equipment to be carried by one person.** The weight of a unit of equipment designed to be carried by one person shall not exceed 16 kg (35 lb). This limit applies to carrying distances up to 10 m (33 ft).
- **6.2.2.6 Maximum weight of units of equipment to be carried by more than one person.** If a unit of equipment is designed to be carried by two people, the weight carried by either one of them shall not exceed 19 kg (42 lb); thus, if the weight of the unit is distributed uniformly, the maximum weight of the unit is 38 kg (84 lb). This limit applies to carrying distances up to 10 m (33 ft).
- **6.2.2.7 Maximum weight of units of equipment to be carried by more than two people.** If a unit of equipment is designed to be carried by more than two people, the total weight shall not exceed 19 kg (42 lb) plus 14.3 kg (31.5 lb) for each person carrying in addition to the first. This increase in weight assumes that the unit is large enough that the people carrying do not interfere with each other. This limit applies to carrying distances up to 10 m (33 ft).
- **6.2.2.8 Lifting eyes or jacking points.** Units of equipment weighing more than 68 kg (150 lb) shall have lifting eyes or jacking points (same as paragraph 6.2.10.1).
- **6.2.2.9 Reducing weight by removing parts.** Heavy pieces of equipment should be made more manageable by designing them with removable parts.
- **6.2.2.10 Labeling heavy units.** Weight and center of gravity caution placards shall be placed on any unit of equipment to be moved for maintenance if its weight exceeds 13.6 kg (30 lbs). Any unit of equipment designed to be lifted or carried by more than one person shall be labeled prominently with its weight and the number of people recommended to lift or carry it (see paragraph 6.3.5.1.3).

### 6.2.3 Size

The size of a unit of equipment affects its weight limits; a large unit intended to be handled by one person cannot weigh as much as a smaller one, as can be seen in exhibit 6.2.2.1. Similarly, a unit intended to be handled by two or more people that is so small that the people interfere with each other cannot weigh as much as a unit that is large enough to avoid such interference.

- **6.2.3.1 Desirable size.** Each unit of equipment should be small enough for one person to lift or carry.
- **6.2.3.2 Reducing size by removing parts.** Units of equipment that are too large to be handled by one person should be designed with removable parts to reduce their size.

## 6.2.4 Shape

- **6.2.4.1 Avoiding protuberances.** Equipment shall be designed with a minimum number of bulges or extensions that might interfere with handling.
- **6.2.4.2 Removing protuberances.** If a unit of equipment includes irregular bulges or extensions that make handling difficult, the bulges or extensions shall be easily removable by hand or with common hand tools.

## 6.2.5 Handles

A handle is a permanent part of a unit of equipment that is designed to be grasped by the hand. Handles may extend out from the unit so that the fingers wrap around them, or they may be recessed areas so that the fingers fit inside an opening. Extended handles may be rigid or folding.

The size, number, and location of handles depend upon: (1) the weight and center of gravity of the unit, (2) the number of people lifting or carrying the unit, (3) the type of clothing worn and whether or not gloves are worn, (4) the position of the unit before handling and its final position, (5) the frequency with which the unit is handled, and (6) any additional uses the handles may serve.

### 6.2.5.1 When handles are needed

- **6.2.5.1.1 Units of equipment designed for carrying.** Units of equipment intended to be carried shall have handles or grasp areas.
- **6.2.5.1.2 Units of equipment weighing less than 4.5 kg (10 lb).** Units of equipment weighing less than 4.5 kg (10 lb) shall have handles if they would otherwise be difficult to grasp, remove, or carry.
- **6.2.5.1.3 Units of equipment weighing between 4.5 and 18 kg (10 to 40 lb).** Units of equipment weighing between 4.5 kg (10 lb) and 18 kg (40 lb) shall have one or more handles that permit easy handling of the unit by one person. If the unit is bulky or if its weight is unevenly distributed, the handles shall permit easy handling by two people.
- **6.2.5.1.4 Units of equipment weighing between 18 and 68 kg (40 to 150 lb).** Units of equipment weighing between 18 kg (40 lb) and 68 kg (150 lb) shall have handles that provide easy handling of the unit by two or more people. If the unit is very large, it shall have lifting eyes (see paragraph 6.2.10.1).
- **6.2.5.1.5 Force limits.** The force exerted pulling or pushing a handle or grasp area shall not exceed the values given in exhibit 6.2.5.1.5 for the appropriate elbow angle. The values provided in the exhibit shall be reduced by 30% if the work is performed in excess of 30 minutes. The values given are projected to a

mixed male and female population by taking two-thirds of the values for a male population. For a more detailed coverage of pulling and pushing limits, see Snook & Ciriello (1991).

**Exhibit 6.2.5.1.5** Maximum force limits for pulling and pushing units of equipment using handles or grasp areas

Degree of elbow flexion °	Pulling		Pushing	
	Left arm N (lbf)	Right arm N (lbf)	Left arm N (lbf)	Right arm N (lbf)
180	148 (33)	154 (35)	125 (28)	148 (33)
150	125 (28)	166 (37)	89 (20)	125 (28)
120	101 (23)	125 (28)	77 (17)	107 (24)
90	95 (21)	110 (25)	65 (15)	107 (24)
60	77 (17)	71 (16)	65 (15)	101 (23)

### 6.2.5.2 Handle characteristics

- **6.2.5.2.1 Handle comfort.** Handles shall be comfortable and easy to grasp; they shall not cut into the hand or cause undue pressure on the fingers.
- **6.2.5.2.2 Handle surface.** The surface of handles shall be sufficiently hard that grit and grime do not become embedded during normal use.
- **6.2.5.2.3 Handle conductivity.** The handle material that comes into contact with a maintainer's hand shall not conduct heat or electricity.
- **6.2.5.2.4 Handle attachment.** Handles shall be permanently attached to the unit of equipment.
- **6.2.5.2.5 Recessed, hinged, and folding handles.** Recessed, hinged, or folding handles may be used to conserve space or to achieve a smooth surface; when they are used, they shall be accessible without the use of tools, and they shall remain securely folded when not in use.
- **6.2.5.2.6 Stops for hinged or folding handles.** Hinged or folding handles shall have a stop that holds them perpendicular to the surface on which they are mounted when they are moved into carrying position. It shall require only one hand to move them into this position.

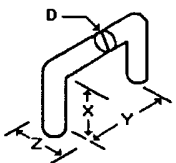
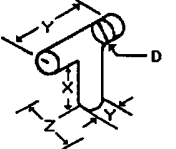
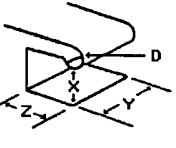
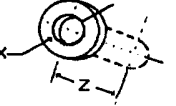
### 6.2.5.3 Dimensions

The dimensions of handles depend primarily upon the type of handle, the weight of the unit of equipment, and the type of hand covering the maintainer wears (none, gloves, or mittens). Other factors affecting handle dimensions include the normal operating position of the unit, the frequency and distance it is lifted or carried, and whether or not the handle has an additional purpose,

such as protecting the front of the equipment or serving as a stand when the equipment is in its maintenance position.

- 6.2.5.3.1 **Minimum handle dimensions by type of handle and hand covering.** Handles shall equal or exceed the dimensions in exhibit 6.2.5.3.1 for the appropriate type of handle and the maintainer's hand covering.

**Exhibit 6.2.5.3.1** Minimum handle dimensions

Type of handle		Bare hand			Gloved hand			Mittened hand			
		X	Y	Z	X	Y	Z	X	Y	Z	
Two-finger bar	mm (in)	32 (1.25)	65 (2.50)	75 (3.0)	38 (1.5)	75 (3.0)	75 (3.0)	N/A	N/A		
	One-hand bar	mm (in)	48 (1.88)	111 (4.37)	75 (3.0)	50 (2.0)	125 (5.0)	100 (4.0)	75 (3.0)	135 (5.25)	150 (6.0)
	Two-hand bar	mm (in)	48 (1.88)	215 (8.5)	75 (3.0)	50 (2.0)	270 (10.5)	100 (4.0)	75 (3.0)	280 (11.0)	150 (6.0)
	T-bar	mm (in)	38 (1.5)	100 (4.0)	75 (3.0)	50 (2.0)	115 (4.5)	100 (4.0)	N/A	N/A	
	J-bar	mm (in)	50 (2.0)	100 (4.0)	75 (3.0)	50 (2.0)	115 (4.5)	100 (4.0)	75 (3.0)	125 (5.0)	150 (6.0)
	Two-finger recess	mm (in)	32 (1.25)	65 (2.5)	50 (2.0)	38 (1.5)	75 (3.0)	50 (2.0)	N/A	N/A	
	One-hand recess	mm (in)	50 (2.0)	110 (4.25)	90 (3.5)	90 (3.5)	135 (5.25)	100 (4.0)	90 (3.5)	135 (5.25)	125 (5.0)
	Finger-tip recess	mm (in)	19 (0.75)	-	13 (0.5)	25 (1.0)	-	19 (0.75)	N/A	N/A	
	One-finger recess	mm (in)	32 (1.25)	-	50 (2.0)	38 (1.5)	-	50 (2.0)	N/A	N/A	

- **6.2.5.3.2 Minimum handle diameter by weight of unit of equipment.** Heavier units require handles of greater diameter. The diameter of the handle shall equal or exceed the value given in exhibit 6.2.5.3.2 for the appropriate weight range.
- **6.2.5.3.3 Finger curl.** The size and shape of a handle shall allow the maintainer's fingers to curl around the handle at least 120°.

**Exhibit 6.2.5.3.2** Minimum handle diameter required by weight of unit of equipment

Weight	Diameter
Up to 6.8 kg: (15 lb)	6 mm: (¼ in)
6.8 to 9.1 kg: (15 to 20 lb)	13 mm: (½ in)
9.1 to 18.1 kg: (20 to 40 lb)	19 mm: (¾ in)
Over 18.1 kg: (40 lb)	25 mm: (1 in)

### 6.2.5.4 Location

The location of handles with respect to the center of gravity of a unit of equipment determines the tendency of the unit to tip or sway when it is lifted or carried. Placing the handles above the center of gravity and placing pairs of handles on opposite sides of the unit on a line passing through the center of gravity horizontally ensure the stability of the unit. However, other considerations may outweigh these "balance" considerations. For example, if a unit is intended to be pulled out of a rack, its handles will probably be located on the front of the unit.

- **6.2.5.4.1 Single handles.** A single handle should be located directly above the center of gravity of a unit of equipment.
- **6.2.5.4.2 Pairs of handles.** The two handles of a pair of handles should be located on opposite sides of the unit of equipment on or above a line passing horizontally through the unit's center of gravity.
- **6.2.5.4.3 Exposure to hazards.** Handles shall be located so that their use does not expose a maintainer to thermal or electrical hazards.
- **6.2.5.4.4 Structural clearance.** Handles shall be located to provide a clearance of at least 50 mm (2 in) between the handle and any obstruction when the equipment is in its installed or maintenance position.

### 6.2.6 Grasp areas

- **6.2.6.1 Location of grasp area.** Grasp areas should be located above the center of gravity of a unit of equipment so that the unit does not tend to tip or sway when it is lifted or carried.
- **6.2.6.2 Grasp area finish.** Grasp areas shall have a nonslip finish. If the bottom of a unit of equipment is designed to serve as a grasp area, the bottom surface shall have a nonslip finish.

- **6.2.6.3 Grasp area material.** The material used for the grasp area shall be sufficiently hard that grit and grime do not become embedded in it during normal use.
- **6.2.6.4 Grasp area conductivity.** Grasp area material shall not conduct heat or electricity.

### 6.2.7 Stands and rests

If a unit of equipment contains components that could be damaged easily during maintenance, stands or rests might be provided to protect the susceptible parts. If the unit has handles, the handles can be designed to serve as the stands or rests.

- **6.2.7.1 Prevention of damage.** If appropriate and practical, units of equipment that contain components that are susceptible to damage shall have stands or rests that protect the susceptible components when the unit is in its maintenance position.
- **6.2.7.2 Integral to chassis.** When provided, stands or rests shall be part of the basic chassis of the unit of equipment.
- **6.2.7.3 Handles as stands or rests.** If a unit of equipment requiring stands or rests has handles, the handles should be designed to serve as the stands or rests.

### 6.2.8 Alignment aids

Ideally it would be impossible to install equipment incorrectly. Alignment aids can help to achieve correct installation. The emphasis in this section is on physical devices, such as guides and pins, but labels can also serve as alignment aids.

- **6.2.8.1 Guides, tracks, and stops.** Guides, tracks, and stops shall be provided wherever appropriate to facilitate handling and to prevent damage to equipment and injury to maintainers.
- **6.2.8.2 Prevention of improper mounting.** Units of equipment shall include physical features (such as supports, guides, or alignment pins) that prevent improper mounting.
- **6.2.8.3 Alignment of light-weight units of equipment.** Units of equipment weighing less than 9 kg (20 lb) should have bottom-mounted alignment pins.
- **6.2.8.4 Alignment of heavy units of equipment.** Units of equipment weighing more than 9 kg (20 lb) should have side-aligning guides so that the unit can be slid into place.
- **6.2.8.5 Labeling units of equipment.** Units of equipment shall have labels that identify their proper alignment, unless the alignment is immediately obvious.
- **6.2.8.6 Labeling insertion holes.** If a unit of equipment has holes through which connectors or other objects that require proper alignment are inserted, the holes shall have labels showing proper alignment of the object to be inserted (same as paragraphs 6.4.6.4 and 6.10.5.18 for modules).

### 6.2.9 Designing for remote handling

- **6.2.9.1 Alignment aids.** All units of equipment designed for remote handling shall have alignment aids.
- **6.2.9.2 Quick-action connectors.** All connectors on units of equipment designed for remote handling shall be of the quick-action type.
- **6.2.9.3 Fasteners.** All fasteners on units of equipment designed for remote handling shall be of the captive type and shall be operable by remote handling techniques.
- **6.2.9.4 Latches.** All latches on units of equipment designed for remote handling shall: (1) be operable from a single point, (2) have positive catches, and (3) provide a clear visual indication of the latch position.

### 6.2.10 Designing for use of hoists, jacks, and cranes

- **6.2.10.1 Lifting eyes or jacking points.** Units of equipment weighing more than 68 kg (150 lb) shall have lifting eyes or jacking points (same as paragraph 6.2.2.8).
- **6.2.10.2 Location of assistance points.** The lifting eyes or jacking points shall be located so that the unit of equipment does not tilt or swing uncontrollably while it is being lifted.
- **6.2.10.3 Labeling.** Lifting eyes and jacking points shall be labeled conspicuously.

## 6.3 Packaging, arrangement, and mounting of equipment

Equipment can be packaged, arranged, and mounted in a variety of ways. This section gives criteria and guidelines to narrow the choices. Several goals and principles underlie the requirements and guidelines of this section. They include:

- a. avoiding irregular, fragile, or awkward extensions to equipment, or, if they cannot be avoided, ensuring that such extensions are easy to remove,
- b. packaging equipment so that it can be handled by one person or as few people as possible,
- c. arranging different units of equipment so that maintenance by one specialist does not require moving or handling equipment maintained by another specialist,
- d. mounting equipment so that it is easily installed or removed and readily accessible for maintenance,
- e. mounting equipment in a way that minimizes the need for the maintainer to bend, stretch, crawl, assume awkward

positions, or move from place to place in performing maintenance tasks, and

- f. minimizing the need for tools, particularly specialized tools.

### 6.3.1 Unitization of equipment

Unitization is the packaging of equipment in physically and functionally distinct units that can be easily removed and replaced. This sort of separation can have a number of advantages, such as providing easy access to malfunctioning equipment, allowing a high degree of standardization, simplifying and speeding equipment design by using previously developed standardized designs, and reducing the skill and training requirements for maintainers.

**Definitions.** A **unit of equipment** is an assemblage of items that may include modules, components, and parts that are packaged together into a single hardware package. For example, a computer, its keyboard, and its visual display are all units of equipment, as are radio transmitters and receivers. A **module** is an assemblage of two or more interconnected parts or components that comprise a single, physical and functional entity. It is this singular functionality that defines a module. A **component** is a subdivision of a unit of equipment that can be treated as an object by the maintainer, but which can be further broken down into parts. A mounting board together with its mounted parts is an example of a component. A **part** is an object that cannot normally be broken down further without destroying its designated use. Fuses, resistors, and capacitors are examples of parts. The **packaging** of a unit of equipment is the assembling, mounting, and enclosing of the items it includes.

- **6.3.1.1 Functional independence.** Units of equipment shall correspond to the functional design of the equipment and shall maximize the functional independence of each unit while minimizing the interaction between units (see paragraph 6.1.2.5).
- **6.3.1.2 Packaging equipment.** Whenever possible, units of equipment shall be independent, interchangeable, and easy to replace.
- **6.3.1.3 Ease of installation.** All equipment shall be easy to mount and easy to connect to other equipment.
- **6.3.1.4 Independent adjustment.** Units of equipment shall be capable of being checked and adjusted separately; when interconnected with other units, they shall require little or no additional adjustment.
- **6.3.1.5 Handling by one person.** Units of equipment should be installable and removable by one person (see section 6.2.2 on weight limits).



- **6.3.1.6 Interconnectivity.** The number of inputs and outputs associated with a unit of equipment shall be minimized.
- **6.3.1.7 Protrusions.** Any irregular protrusions on a unit of equipment, such as cables, waveguides, or hoses, shall be easily removable to prevent damage during installation and maintenance.
- **6.3.1.8 Prevention of incorrect mounting.** Units of equipment should be designed so that they cannot be mounted incorrectly.

### **6.3.2 Interchangeability, noninterchange- ability**

Units of equipment may be interchangeable physically, functionally, or both. This section contains requirements and guidelines that might be summarized in the general statements that if two units of equipment are interchangeable functionally, they will also be interchangeable physically; if they are not interchangeable functionally, they will not be interchangeable physically.

- **6.3.2.1 Interchangeability of equivalent units of equipment.** Units of equipment having the same form and function shall be interchangeable throughout a system and related systems (see paragraph 6.1.3.2).
- **6.3.2.2 Identifiability of interchangeable units of equipment.** Interchangeable units of equipment shall be clearly identifiable and easily distinguishable from units that are similar, but not interchangeable. Identification methods might be physical (such as size, shape, and mounting provisions), visual (such as color coding), or verbal (such as labeling).
- **6.3.2.3 Noninterchangeability of nonequivalent units of equipment.** Units of equipment that are not functionally interchangeable shall not be physically interchangeable (see paragraph 6.1.3.3).
- **6.3.2.4 Identifiability of noninterchangeable units of equipment.** Noninterchangeable units of equipment shall be clearly identifiable and readily distinguishable from units that are interchangeable. Identification methods might be physical (such as size, shape, and mounting provisions), visual (such as color coding), or verbal (such as labeling).

### **6.3.3 Mounting in drawers, on racks, and on hinges**

#### **6.3.3.1 General**

- **6.3.3.1.1 Mounting frequently-moved units of equipment.** When appropriate, units of equipment that must be moved frequently from their installed positions for maintenance shall be mounted in drawers, on sliding racks, or on hinges.

- **6.3.3.1.2 Mounting of heavy units of equipment.** When appropriate, heavy, relatively inaccessible units of equipment that must be inspected or maintained shall be mounted in drawers, on sliding racks, or equipment covers on hinges.
- **6.3.3.1.3 Access to rear or bottom of units of equipment.** If the maintainer must have access to the rear or bottom of units of equipment mounted in drawers, on sliding racks, or equipment covers on hinges, the units shall open or rotate fully and remain in that position (held by braces, for example) without being supported by the maintainer.
- **6.3.3.1.4 Avoidance of instability.** If opening or extending a unit of equipment that is mounted in a drawer, on a sliding rack, or on hinges would shift the center of gravity of the mounting structure so that it becomes unstable, the structure shall be securely fastened.
- **6.3.3.1.5 Attachment of equipment.** Units of equipment mounted in drawers, on sliding racks, or on hinges should be attached only to the drawer, rack, or hinge and to interconnecting lines and cables.
- **6.3.3.1.6 Ease of moving mounted units of equipment.** When units of equipment are mounted in drawers, on sliding racks, or on hinges, the drawers, racks, or hinges shall be easy (require few operations) to open or extend.
- **6.3.3.1.7 Maximum force to move mounted units of equipment.** The force needed to open or rotate a drawer, slide, or hinged mount shall not exceed the values given in paragraph 6.2.5.1.5.
- **6.3.3.1.8 Guards and shields.** If needed to protect fragile or sensitive components, drawers and racks should include guards or shields.

### 6.3.3.2 Restraints and supports

Equipment mounted in drawers, on sliding racks, or on hinges must be protected with stops or supports that prevent it from falling or tipping over and that hold it in position both for operation and for maintenance. These stops and supports must be easily overridden so that the equipment can be easily removed and replaced.

- **6.3.3.2.1 Limit stops.** Limit stops shall be provided on all drawer-, slide-, or hinge-mounted equipment that must be moved from its operating position to a maintenance position.

**Definition. Limit stops** are mechanisms that restrict a moving object or part by stopping it at predetermined (limit) positions.

- **6.3.3.2.2 Automatic locks.** Drawers and slides shall lock automatically in both the operating and maintenance positions.

- **6.3.3.2.3 Lock release.** The locks holding drawers and slides in the operating and maintenance positions shall be easy to release, preferably requiring only one hand to operate.
- **6.3.3.2.4 Supports for hinge-mounted equipment.** Hinge-mounted equipment shall have a means of support to hold it in both the operating and maintenance positions.

### 6.3.3.3 External connectors and interlocks

- **6.3.3.3.1 Preservation of external connections.** If external connections are required for maintenance as well as for normal operation, mounting shall be designed so that these connections are not broken when the unit of equipment is slid or rotated into its maintenance position.
- **6.3.3.3.2 Breaking of external connections.** If it is required that external connections be broken for maintenance, interlocks shall be provided that break the connections when the equipment is slid or rotated into its maintenance position.
- **6.3.3.3.3 External connectors as part of supporting structure.** If equipment mounted in a drawer or on a sliding rack is intended to be removed and replaced by maintainers, and if external connections are not required during maintenance, the drawer or rack shall be provided with connectors on the rear of the equipment that mate with connectors mounted on the structure.

### 6.3.4 Positioning equipment

Some general considerations affecting the positioning of equipment are:

- a. Avoid locations where the equipment or the maintainer would be exposed to damage or injury.
- b. Avoid locations where the equipment or the maintainer would be exposed to oil, dirt, or other contaminants.
- c. Choose the most accessible locations for the most frequently serviced equipment.
- d. Choose the most accessible locations for the heaviest or bulkiest equipment.
- e. Choose the most protected locations for the most fragile or sensitive equipment.

#### 6.3.4.1 Physical accessibility

- **6.3.4.1.1 Complete visual and physical access.** Equipment shall be positioned so that the maintainer has complete visual and physical access to all parts of the equipment on which maintenance is performed; this includes access openings,

adjustment points, test points, cables, connectors, labels, and mounting fasteners.

- **6.3.4.1.2 Freedom from structural obstruction.** Units of equipment shall be positioned so that neither visual nor physical access is obstructed by structural members or permanently installed equipment.
- **6.3.4.1.3 Working space.** Units of equipment shall be positioned so that there is sufficient space around them for the use of any tools and test equipment required for their maintenance (see also paragraph 9.1.3 and section 9.2.2, particularly paragraph 9.2.2.1.1).
- **6.3.4.1.4 Room to open covers.** Units of equipment shall be positioned with sufficient clearance from other equipment and structures to permit unhindered opening of any covers that are opened during maintenance tasks.
- **6.3.4.1.5 Stacking or blocking equipment.** Units of equipment shall not be stacked or placed in front of or behind other units; each unit shall be positioned so that it is both visually and physically accessible without the removal of another unit.
- **6.3.4.1.6 Full extension or rotation.** Units of equipment mounted in drawers, on sliding racks, or on hinges shall be positioned so that the drawer, rack, or hinge can be opened or extended without hindrance.
- **6.3.4.1.7 Working level.** Units of equipment should be positioned so that they are at the most favorable working level; this is usually between the maintainer's hip and shoulder height, from approximately 1 to 1.5 m (3 to 5 ft).
- **6.3.4.1.8 Visual access.** Units of equipment that require frequent visual inspection shall be positioned so that the components to be inspected (such as displays, test points, and labels) can be seen easily without the removal of any other equipment.
- **6.3.4.1.9 Removal path.** Units of equipment intended to be replaceable by maintainers shall be positioned so that they can be removed along a straight or moderately curved path, not along a sharply bent path.

### 6.3.4.2 Relative accessibility

In addition to considerations of physical accessibility, the positioning of equipment is affected by its indispensability, the frequency with which it is serviced or maintained, the relationship of one unit of equipment to other units, and the difficulty with which it is serviced or maintained.

- **6.3.4.2.1 Criticality of equipment.** The most critical units of equipment shall be the most accessible. Accessibility may be compromised for highly reliable critical equipment.

- **6.3.4.2.2 Frequency of access.** If criticality is not a factor, equipment requiring the most frequent servicing or maintenance shall be the most accessible.
- **6.3.4.2.3 Grouping to minimize movement.** Units of equipment maintained by the same person shall be positioned near each other (provided the operational grouping of equipment remains in close proximity) to minimize the amount of movement required of the maintainer.
- **6.3.4.2.4 Noninteraction with equipment maintained by others.** Access to units of equipment maintained by one type of maintenance specialist shall not require moving equipment maintained by another type of specialist. When conflicts with paragraphs 6.3.4.2.1 through 6.3.4.2.3 occur, the previous paragraphs shall have priority.
- **6.3.4.2.5 Difficulty of moving.** Units of equipment that are difficult to move shall not prevent convenient access to other units.
- **6.3.4.2.6 Noninteraction with equipment not in need of maintenance.** It shall not be necessary to remove or disable an operable unit of equipment to obtain access to a unit requiring maintenance.

### 6.3.5 Labeling and marking

Labels on equipment can be used to (1) identify the equipment, (2) state warnings or cautions, (3) supply useful information, such as instructions, the weight of the equipment, or calibration information, and (4) record and supply historical data, such as periodic readings or the date of servicing or replacement.

**Definitions.** A **label** is alphanumeric information that identifies or describes an object. Labels can be printed directly on or adjacent to the object, or they can be printed on a card or plate that is attached to the object or adjacent to the object. **Marking** is nonverbal information, such as colors or symbols, that identifies or describes an object. Marking can appear directly on or adjacent to the object, or it can be printed on a card or plate that is attached to the object or adjacent to the object.

#### 6.3.5.1 Types of labels

- **6.3.5.1.1 Equipment identification.** All units of equipment shall have identifying labels. These labels shall be securely attached, permanent, nonfading, oil-, gasoline-, and corrosion-resistant, and shall include all of the following that are applicable: (1) contract order or task number, (2) equipment name, (3) specification number, (4) manufacturer's part number, (5) serial number, (6) manufacturer's name and address, and (7) if necessary, stock number.

**Discussion.** Note that 29 CFR 1910.303 (e) requires that electrical equipment itself must have a manufacturers

name or trademark or other descriptive material which identifies product responsibility and includes markings giving voltage, current, wattage or other ratings.

- **6.3.5.1.2 Hazard labels.** If any hazard exists in servicing or maintaining a unit of equipment, the equipment shall have a warning label attached that describes the hazard (see section 12.16).

**Discussion.** Electrical equipment that is to be used in hazardous locations must be marked to show the hazardous location class and group (from National Fire Protection Association 70) and operating temperatures.

- **6.3.5.1.3 Weight labels.** Weight and center of gravity caution placards shall be placed on any unit of equipment to be moved for maintenance if its weight exceeds 13.6 kg (30 lbs). If it is designed to be lifted or carried by more than one person, the label shall include the number of people recommended to lift or carry it (see paragraph 6.2.2.10; same as paragraph 12.16.15).
- **6.3.5.1.4 Instruction labels.** If there are critical instructions for the servicing or maintenance of a unit of equipment, and if these instructions are not likely to be available through other means, they shall be provided in a label on the equipment.
- **6.3.5.1.5 Data labels.** If there are critical data that must be available to or recorded by the maintainer of a unit of equipment, and if there is no other provision for them, a label shall be provided for these data.

### 6.3.5.2 Location and orientation

- **6.3.5.2.1 Readability.** Equipment labels shall be located so that they are visible and readable with the equipment in its installed position (same as paragraph 7.5.2.1).
- **6.3.5.2.2 Preserving readability.** Equipment labels shall be located so that they will not become obscured by dirt, moisture, or other foreign materials. If these materials are likely to accumulate, the labels shall be mounted on a vertical surface (same as paragraph 7.5.2.10).
- **6.3.5.2.3 Consistent location.** Labels on similar units of equipment should be placed in approximately the same location on each (same as paragraph 7.5.2.7).
- **6.3.5.2.4 Horizontal orientation.** Labels shall be oriented so that alphanumeric characters are read horizontally, not vertically (same as paragraph 7.5.2.9).

### 6.3.5.3 Typographic matters

- **6.3.5.3.1 Character height for viewing distance.** Unless circumstances require otherwise, labels shall be clearly legible at a viewing distance of 710 mm (28 in). The recommended height for letters and numerals at this distance is approximately 5 mm (.18 in). Exhibit 6.3.5.3.1 gives minimum character heights for other viewing distances.

#### Exhibit 6.3.5.3.1 Minimum character height for various viewing distances

Viewing distance	Minimum height
Less than 0.5 m (20 in)	2.3 mm (0.1 in)
0.5 - 1.0 m (20 - 40 in)	4.7 mm (0.2 in)
1.0 - 2.0 m (40 - 80 in)	9.4 mm (0.4 in)
2.0 - 4.0 m (80 - 160 in)	18 mm (0.75 in)

- **6.3.5.3.2 Stroke width in normal illumination.** If labels are expected to be read under normal illumination, characters shall be black on a white or light background, and stroke width shall be 1/6 to 1/7 of the height (same as paragraph 7.5.3.2).
- **6.3.5.3.3 Stroke width in dim illumination.** If labels are expected to be read under dim illumination, characters shall be white on a black or dark background, and stroke width shall be from 1/7 to 1/8 of the height (same as paragraph 7.5.3.3).
- **6.3.5.3.4 Width to height ratios.** The width to height ratio of letters and numerals shall be 3:5 with the exceptions of "M" and "W," which shall be 4:5, "4," which shall be one stroke width wider, and "I" and "1," which shall be one stroke wide (same as paragraph 7.5.3.5).
- **6.3.5.3.5 Character spacing.** The spacing between characters shall be at least one stroke width (same as paragraph 7.5.3.6).
- **6.3.5.3.6 Word spacing.** The spacing between words shall be approximately the width of one normal-width character (same as paragraph 7.5.3.7).
- **6.3.5.3.7 Line spacing.** The spacing between lines shall be approximately least one-half the character height (same as paragraph 7.5.3.8).
- **6.3.5.3.8 Case of letters.** If the text on a label is exclusively single words, such as names, the words shall appear as all capital letters; if the text is phrases or sentences, the text shall appear as mixed case letters (same as paragraph 7.5.3.9).

- **6.3.5.3.9 Text and background combinations.** Text and background combinations shall provide sufficient contrast to ensure legibility. Black characters may appear on white, yellow, light gray, matte-finished brass or aluminum, or any bright plated backgrounds; white characters may appear on dark backgrounds; other acceptable combinations are blue on white, green on white, green on red, and red on yellow.

#### 6.3.5.4 Wording

- **6.3.5.4.1 Consistency.** Designations and terms used on labels shall be consistent with designations and terms in user documentation and parts catalogs.
- **6.3.5.4.2 Wording.** The wording of labels should be brief but explanatory, using words that are familiar to maintainers. Abbreviations and abstract terms should be used only if it can be reasonably expected that they will be known to all maintainers.
- **6.3.5.4.3 Instructions.** Labels containing a series of steps to be carried out should list the steps, not present them in paragraph form.

#### 6.3.5.5 Markings

- **6.3.5.5.1 Number of color codes.** If color coding is used, the number of different colors shall not exceed nine.
- **6.3.5.5.2 Recommended colors.** If color coding is used, the colors shall be distinguishable by both color-normal and color-deficient persons. Colors meeting this criterion are given in exhibit 6.3.5.5.2.

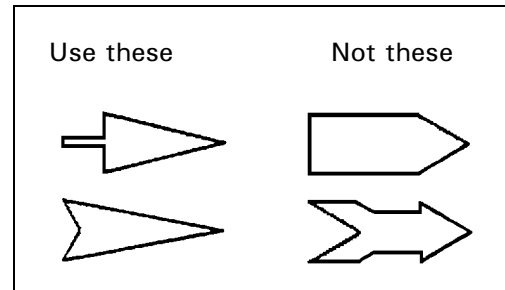
**Exhibit 6.3.5.2** Recommended colors

<u>Color</u>	<u>Spec No*</u>
Red	1110
Orange	1210
Yellow	1310
Blue	10B 7/6
Purple	2715
Gray	1625
Buff	1745
White	1755
Black	1770
* From Fed. Spec. II-C-595 except for blue, which is from Munsell (1942)	



- **6.3.5.5.3 Arrows.** Arrows used in labels or markings should be clearly recognizable and easily identifiable from a distance. Sharp angles and a tapered overall shape are preferable to wide angles and a relatively uniform overall shape (see exhibit 6.3.5.5.3).

**Exhibit 6.3.5.5.3** Good and bad arrows



## 6.4 Access openings

This section contains criteria and guidelines for access openings, that is, openings in a case, cover, panel, or door through which a maintainer requires visual or physical access or both, to perform maintenance tasks. Criteria and guidelines are given for properties of the openings, how to ensure both visual and physical access, the size, shape, and location of the openings, and their labeling. Criteria and guidelines regarding covers for access openings are given in section 6.5.

### 6.4.1 General

- **6.4.1.1 When an access opening is required.** An access opening shall be provided whenever a maintenance task would otherwise require removing a case or covering, opening a fitting, or dismantling a unit.
- **6.4.1.2 Number of openings.** When appropriate, one large opening should be provided rather than several small ones.
- **6.4.1.3 Prevention of injury or damage.** The edges of access openings shall be either (1) sufficiently rounded and smoothly finished or (2) covered or coated sufficiently to prevent injury to the maintainer's person, clothing, and equipment (see paragraph 12.5.1.4).
- **6.4.1.4 Uncovered openings.** When environmental, operational, and safety conditions permit, openings should be left uncovered (same as paragraph 6.5.7.1).
- **6.4.1.5 Unacceptability of rivets.** Riveted panels or doors shall not be used to cover access openings. Quick-action fasteners shall be used except in cases when the panel or door is subjected to stress or pressure, in which case screws shall be used.

### 6.4.2 Access



- **6.4.2.1 Visual and physical access.** If a maintainer must see what he or she is doing inside the opening, then either the opening shall be large enough and positioned so that the maintainer has the necessary view, or separate openings shall be provided for visual and physical access.

- **6.4.2.2 Visual access only.** If a maintenance task requires only visual access, the access opening should be designed and positioned so that the maintainer can see whatever is needed without removing panels or other components. Such openings should not compromise personnel safety.
- **6.4.2.3 Physical access only.** Physical access without visual access, that is, access in which the maintainer cannot see what he or she is doing inside an access opening, shall not be provided without approval of the acquisition program office.

### 6.4.3 Size







- **6.4.3.1 Accommodation.** An access opening shall be large enough to accommodate whatever combination of components, tools, body parts, clothing, and movements is required to perform the task.
- **6.4.3.2 Dimensions for one- or two-finger access.** Dimensions of openings intended to allow access by one or two fingers shall equal or exceed those given in exhibit 6.4.3.2.

**Exhibit 6.4.3.2** Minimum dimensions of openings designed for access by one or two fingers without visual access

	<b>Action</b>	<b>Bare hand mm (in)</b>	<b>Gloved hand mm (in)</b>
	Push button	32 (1.25)	38 (1.5)
	Turn knob having diameter X	X + 50 (2.0)	X + 65 (2.5)

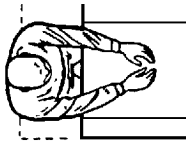
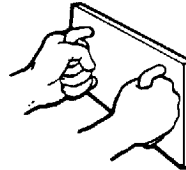
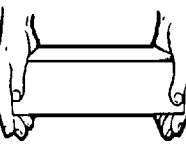
- 6.4.3.3 **Dimensions for one hand or arm access.** Dimensions for openings intended to allow access by one hand or one arm shall equal or exceed those given in exhibit 6.4.3.3.

**Exhibit 6.4.3.3** Minimum dimensions of openings designed for access by one hand or arm without visual access

		Height mm (in)	Width mm (in)	Diameter mm (in)
<b>Empty hand, to wrist</b>				
	Bare hand, flat	55 (2.25)	100 (4.0)	100 (4.0)
	Bare hand, rolled	95 (3.75)	95 (3.75)	95 (3.75)
	Glove or mitten	100 (4.0)	150 (6.0)	150 (6.0)
	Arctic mitten	125 (5.0)	165 (6.5)	165 (6.5)
<b>Clenched hand, to wrist</b>				
	Bare hand	5 (3.75)	125 (5.0)	125 (5.0)
	Glove or mitten	115 (4.5)	150 (6.0)	150 (6.0)
	Arctic mitten	180 (7.0)	215 (8.5)	215 (8.5)
<b>Hand plus 25 mm object, to wrist</b>				
	Bare hand	95 (3.75)	95 (3.75)	95 (3.75)
	Glove or mitten	150 (6.0)	150 (6.0)	150 (6.0)
	Arctic mitten	180 (7.0)	180 (7.0)	180 (7.0)
<b>Hand plus X mm object, to wrist</b>				
	Bare hand	X + 45 (1.75) clearance around object		
	Glove or mitten	X + 65 (2.5) clearance around object		
	Arctic mitten	X + 90 (3.5) clearance around object		
<b>Arm to elbow</b>				
	Light clothing	100 (4.0)	115 (4.5)	115 (4.5)
	Arctic clothing	180 (7.0)	180 (7.0)	180 (7.0)
	With object	Same clearances as hand plus object		
<b>Arm to shoulder</b>				
	Light clothing	125 (5.0)	125 (5.0)	125 (5.0)
	Arctic clothing	215 (8.5)	215 (8.5)	215 (8.5)
	With object	Same clearances as hand plus object		

- 6.4.3.4 **Dimensions for two-hand access.** Dimensions of openings intended to allow access by two hands shall equal or exceed those given in exhibit 6.4.3.4.

**Exhibit 6.4.3.4** Minimum dimensions of openings designed for access by two hands without visual access

	<p><u>Reaching with both hands to depth of 150 to 500 mm (6 to 20 in):</u></p>
	<p>Light clothing: Width: 200 mm (8 in) or depth of reach* Height: 125 mm (5 in)</p>
	<p>Arctic clothing: Width: 150 mm (6 in) plus ¼ the depth of reach Height: 180 mm (7 in)</p>
	<p><u>Reaching full arm's length (to shoulders) with both arms:</u></p>
	<p>Width: 500 mm (20 in) Height: 125 mm (5 in)</p>
	<p><u>Inserting box grasped by handles on front:</u> 13 mm (½ in) clearance around box, assuming adequate clearance around handles</p>
	<p><u>Inserting box with hands on the sides:</u> Light clothing: Width: Box plus 115 mm (4½ in) Height:† 125 mm (5 in) or 13 mm (½ in) around box*</p>
	<p>Arctic clothing: Width: Box plus 180 mm (7</p>

## 6.4.4 Shape

As with size, the shape of an access opening is influenced by: (1) the body appendages and equipment that will pass through the opening, (2) the movements the maintainer will perform inside the opening, and (3) the maintainer's need for visual access through the opening. The shape need not be a conventional shape such as a circle or rectangle.

- 6.4.4.1 **Shape appropriate to task.** The shape of an access opening shall allow the maintainer to perform those tasks requiring access through the opening.

## 6.4.5 Location

- 6.4.5.1 **On accessible surfaces.** Access openings shall be located on equipment surfaces that are accessible when the equipment is in its normal operating position.

- **6.4.5.2 Near related displays, controls, and connectors.** Access openings shall be located within easy view and reach of any test points, displays, controls, or connectors that require access in performing a particular maintenance task.
- **6.4.5.3 Away from hazards.** Access openings shall be located at a safe distance or shielded from any hazards such as high voltages or dangerous moving parts to which the maintainer might be exposed.
- **6.4.5.4 Comfortable for maintainer.** Access openings shall be located so that they do not require undue bending, stretching or other awkward body postures of the maintainer while he or she performs required tasks.
- **6.4.5.5 Easy removal of components.** Access openings should be located so that heavy or bulky components can be pulled out rather than lifted out.
- **6.4.5.6 Conformance with related items.** If work stands or carts are used in the maintenance tasks, access openings shall conform to the height of the stands or carts.
- **6.4.5.7 Free of obstructions.** Access openings shall be located so that it is not necessary to remove any components or wires to reach them.
- **6.4.5.8 Impervious to environmental conditions.** Access openings shall be located so that environmental conditions such as rain, snow, and ice neither interfere with access nor damage components when the access is open.

## 6.4.6 Labeling and marking

The criteria and guidelines in this section apply only to labeling and marking access openings; if the opening has a cover, the relevant criteria and guidelines are given in section 6.5.10.

- **6.4.6.1 Identification of opening.** Each access opening shall be labeled with a name, number, letter or other symbol and referred to by that identification in maintenance instructions.
- **6.4.6.2 Identification of accessible components and maintenance tasks.** Each access opening should be labeled with identifiers for the maintainable components accessible through the opening. This labeling may also include information about equipment to be used in the maintenance tasks and procedural information about the tasks themselves.
- **6.4.6.3 Warning labels.** If any hazardous condition exists inside an access opening (such as high voltages or dangerous moving parts), the opening shall have a conspicuous warning label advising the maintainer of the hazard and stating any necessary precautions (see section 12.16).
- **6.4.6.4 Insertion holes.** If a unit of equipment has holes through which connectors or other objects are inserted, the holes shall

## 6.5 Covers, guards, and shields

have labels showing the proper alignment of the object to be inserted (same as paragraphs 6.2.8.6 and 6.10.5.18 for modules).

This section contains criteria and guidelines governing the size, shape, location, fastening, and labeling of covers, guards, and shields.

**Definitions.** A **cover** is a part of a unit of equipment that closes an access opening. A **shield** is an enclosure or barrier intended to protect components that are susceptible to damage or to protect maintainers from possible injury. A **guard** is an enclosure or barrier intended to prevent inadvertent or unauthorized operation of a control.

Covers, guards, and shields may take a variety of forms, including (1) hinged doors or caps, (2) sliding doors or caps, (3) removable doors or caps, (4) removable panels, and (5) physical barriers.

Hinged doors and caps allow the fastest and easiest access; they require few fasteners and, depending upon their orientation, may not need support in the open position. They do require "swinging" space, and they may intrude on the maintainer's work space.

Sliding doors or caps are particularly useful where "swinging" space is limited. They do not generally provide a tight seal.

Removable doors or caps require little space for opening and, once removed, do not interfere with working space. Handling them does take time and effort.

Removable panels can give access to large portions of a unit of equipment. They do not require "swinging" space, but they may be awkward to handle or susceptible to damage.

### 6.5.1 General

- **6.5.1.1 How to open.** It shall be clear to the maintainer how to open a cover, either through a property of the cover itself, such as its shape, or by the provision of instructions on or near the cover (see also paragraph 6.5.10.1).
- **6.5.1.2 Ease of opening.** Covers and fasteners should be selected or designed so that their combination makes the cover easiest to remove, open, and close while meeting the closure and structural requirements of the equipment (see also paragraphs 6.5.7.2 and 6.5.8.2).

**Example.** A cover that is opened relatively frequently but that does not need to be sealed tightly might be a hinged door with a quick-release latch.

- **6.5.1.3 Fastened-unfastened indication.** Covers shall be designed or mounted so that it is clear whether or not they are

fastened when they are in place (same as paragraph 6.6.3.5 for cases).

**Example.** Covers might be spring loaded so that they stay open when they are not fastened.

- **6.5.1.4 Handles or grasp areas.** If a cover is heavy or difficult to open or handle, it shall have one or more handles, grasp areas, or both. If present, handles and grasp areas shall accommodate any gloves or other special clothing the maintainer might be expected to wear (see section 6.2.5 for criteria and guidelines for handles).
- **6.5.1.5 Shift in balance of equipment.** Hinged or sliding doors shall not unbalance equipment when they are opened.

**Discussion.** If an imbalance would otherwise result, the cover or the equipment might have some sort of prop or support to prevent the unbalance.

- **6.5.1.6 Stops and retaining devices.** Attached covers shall have stops or retaining devices that hold them in both the open and closed positions. These stops and retainers shall be appropriate to the ambient environment.

**Example.** An access door on equipment out of doors and subject to wind would need a more secure restraint than one on equipment located indoors.

- **6.5.1.7 Ventilation holes.** If a cover or shield requires ventilation holes, the holes shall be small enough to prevent inadvertent insertion of objects that might touch high voltage sources or moving parts (same as paragraph 12.5.2.3).
- **6.5.1.8 Rounded edges.** The corners and edges of covers shall be smooth or rounded so that they do not injure the maintainer or damage his or her clothing (see paragraph 12.5.1.4; same as paragraph 6.6.1.7 for cases).
- **6.5.1.9 Small removable covers.** Small removable caps or covers that might be susceptible to dropping or loss, perhaps with resulting damage to components inside the opening, shall be attached to the equipment or structure.

## 6.5.2 Size

- **6.5.2.1 Size of covers.** Covers shall be as small and light in weight as possible while meeting the closure, structural, and ease of maintenance requirements of the equipment.

**Discussion.** It is most desirable that covers be openable, removable, and transportable with one hand; next most desirable that they require handling by only one person;

least desirable, that they require handling by two or more people.

### 6.5.3 Shape

- **6.5.3.1 Appropriate to opening.** The shape of a cover shall be appropriate to the opening it covers and shall provide the degree of closure required.
- **6.5.3.2 Proper orientation.** If a removable access cover requires a particular orientation, the cover shall be designed to prevent attachment in any other orientation.

**Example.** This might be accomplished by: (1) giving the cover an asymmetric or irregular shape, (2) including alignment guides or pins, or (3) arranging the holes for fasteners asymmetrically.

### 6.5.4 Location

Most of the location considerations are preempted by those governing the location of the openings. Location considerations specific to covers include: (1) accessibility of the covers themselves with the equipment in its installed position, (2) accessibility of the fasteners, and (3) location of attached covers so that in their open positions they do not obstruct or interfere with maintenance tasks.

- **6.5.4.1 Accessible with equipment in installed position.** When maintenance tasks require that a cover be opened with the equipment in its installed position, both the cover and its fasteners shall be located so that they are visually and physically accessible with the equipment in that position.
- **6.5.4.2 Noninterference of open cover with accessibility.** Hinged and sliding covers shall be located so that when they are open, they do not interfere with access to the openings themselves, or to related controls, displays, test points, and the like.

### 6.5.5 Hinged covers

- **6.5.5.1 Safe operation.** Hinged covers shall be designed so that opening and closing them will not interfere with, damage, or have the potential for harmful contact with wires or other components.
- **6.5.5.2 Self-supporting.** Hinged covers shall have stops or retainers that hold them in the open position. These stops shall also prevent the cover from swinging into or falling on fragile equipment, from swinging into the maintainers themselves, and from springing the hinges.
- **6.5.5.3 Operable with one hand.** The maintainer should be able to open and close a hinged cover using only one hand.



**6.5.6 Sliding doors and caps**

- **6.5.6.1 Safe operation.** Sliding doors and caps shall be designed so that opening and closing them will not interfere with, damage, or have the potential for harmful contact with wires or other components.
- **6.5.6.2 Positive locking.** Sliding doors and caps should lock in the closed position, giving the maintainer feedback, perhaps with a "snap" action or an audible click, when they are closed. They should also lock and give feedback in the open position unless they are removed when opened.
- **6.5.6.3 Nonjamming.** Sliding doors and caps should not bind or jam while being opened or closed.
- **6.5.6.4 Easy hand operation.** Sliding doors and caps should be easy to open and close without the use of tools.

**6.5.7 Preferred type of covering**

- **6.5.7.1 Uncovered openings.** When environmental, operational, and safety conditions permit, openings should be left uncovered (same as paragraph 6.4.1.4).
- **6.5.7.2 Preferred type of cover.** The cover of an access opening shall be appropriate to the type of access required and the prevailing environmental conditions as outlined in exhibit 6.5.7.2 (see also paragraph 6.5.1.2).

**Exhibit 6.5.7.2 Type of covering appropriate for type of access and environmental conditions**

Condition	Physical access	Visual access
No adverse condition	No cover	No cover
Debris, moisture, other foreign material present	Hand-operated, latched, sliding or hinged cap or door, or, less desirable, a removable panel with captive, quick-action fasteners	Transparent plastic window
Subject to wear or contact with solvents		Break-resistant glass window
Stress or pressure requirements	Removeable panel with the smallest number of the largest screws that meet the requirements	Opaque cover plate with the smallest number of the largest screws that meet the requirements

## 6.5.8 Fasteners

- **6.5.8.1 Fastener security.** Fasteners shall hold covers securely in their operating environment, for example, withstanding the effects of vibration, wind gusts, and pressure (same as paragraphs 6.6.4.1 for cases and 6.7.1.1 for fasteners).
- **6.5.8.2 Number and ease of opening.** The fasteners for a given cover shall be the fewest in number and the simplest to operate that meet the closure, structural, and ease of maintenance requirements for the cover (see also paragraph 6.5.1.2; same as paragraph 6.6.4.2 for cases and 6.7.1.2 for fasteners).
- **6.5.8.3 Common fasteners.** The fasteners for a given cover shall be interchangeable with the fasteners for other covers on the same equipment and with fasteners for similar covers on other equipment (same as paragraph 6.6.4.3 for cases and 6.7.1.3 for fasteners).
- **6.5.8.4 Captive fasteners.** Captive fasteners should be used for covers (see also paragraph 6.7.3.7.4; same as paragraph 6.6.4.4 for cases).
- **6.5.8.5 Quick-action fasteners.** Fasteners for covers should be of the quick-action type, requiring only part of a turn or a snap action to fasten and unfasten (same as paragraph 6.6.4.5 for cases).
- **6.5.8.6 Self-alignment.** Fasteners for covers shall be selected or designed so that they are easily aligned with their retaining catches, nuts, blocks, or inserts. This alignment shall occur without binding and without damage to fastener threads or receptacles (same as paragraph 6.6.4.6 for cases and 6.7.1.4 for fasteners).
- **6.5.8.7 Operable by hand or common hand tools.** Fasteners shall be operable by hand if possible; otherwise, by common hand tools (same as paragraph 6.6.4.7 for cases and 6.7.1.5 for fasteners).
- **6.5.8.8 Opened-closed indication.** Fasteners should give a clear indication that they are open (unfastened) or closed (fastened; same as paragraph 6.6.4.8 for cases and 6.7.1.6 for fasteners).
- **6.5.8.9 Hole size.** The holes in covers or shields through which fasteners pass shall be large enough to permit inserting or "starting" the fasteners even when the covers or shields are not perfectly aligned (same as paragraph 6.6.4.9 for cases and 6.7.1.7 for fasteners).
- **6.5.8.10 Covers as structural members.** When covers serve as stress-bearing structural members, their fasteners shall be large and strong enough to withstand the stress.

- **6.5.8.11 Pin-and-hook fasteners.** If a cover must have the ability to survive nuclear, biological and chemical hazards, it should be attached with pins and hooks rather than hinges (same as paragraph 6.7.3.5.4 for fasteners).

## 6.5.9 Interlocks

Interlocks are distinguished from lockouts and tagouts.

**Definitions. Interlocks** are devices (for example, switches) connected with a cover, shield, or case that disable the associated internal hazard (usually electrical) when the cover, shield, or case is opened. OSHA regulations discuss lockout and tagout procedures to be used in the workplace during maintenance or operations to protect from electrical hazards. A **lockout** uses a mechanical means to disable a control or switch in its safe position (for example, electricity disconnected) and to prevent its activation without the use of undue force or tools. **Tagouts** are tags that are attached to a control or place of hazard to identify the required control condition and hazard associated with an ongoing mode of operation or maintenance.

- **6.5.9.1 Protection from hazards.** If a hazardous condition (such as a high voltage or moving parts) exists behind a cover or shield, that cover or shield shall have an interlock that disables the hazard when the cover or shield is removed or opened (see paragraphs 12.4.1.9 and 12.4.1.10; same as paragraph 6.6.5.1 for cases). Human protection from hazardous conditions with unexpected energization or release of stored energy is treated in 29 CFR 1910.301 -308, 331 -335, and 399. The OSHA regulation 29 CFR 1910.333 (B) (2) (iii) requires the simultaneous use of both tagout and lockout in the workplace; 29 CFR 1910.333 (b) (ii) (B) states that interlocks shall not be the sole means of de-energizing circuits of equipment and are not substitutes for lockout and tagout procedures and practice (see paragraph 12.4.1.11).
- **6.5.9.2 Interlock override switch.** If a task requires that a maintainer work on hazardous equipment that is equipped with a disabling interlock, the equipment shall have an interlock override switch that permits manual bypassing or overriding of the interlock when the cover is open. This override switch shall automatically reset to the non-by-pass position which is the safe operating position when the cover is replaced (same as paragraph 6.6.5.2 for cases and 12.4.1.11). OSHA 29 CFR 1910.333 requires that only qualified personnel be allowed to disable an interlock.
- **6.5.9.3 Labeling covers with interlocks.** If a cover or shield has an interlock, a label stating the presence of both the hazard and the interlock shall be placed on the equipment or the cover so that it is visible both when the cover is in place and when it is open (same as paragraph 6.6.5.3 for cases).

### 6.5.10 Labeling and marking

This section contains criteria and guidelines for labeling and marking covers; criteria and guidelines that apply to labeling and marking the openings themselves are given in section 6.4.6.

- **6.5.10.1 Method of opening.** If the method for opening a cover is not obvious, a label with opening instructions shall be attached to the outside of the cover itself or to the equipment adjacent to the cover (see also paragraph 6.5.1.1; same as paragraph 6.6.6.1 for cases).
- **6.5.10.2 Hazard labels.** If a hazardous condition exists behind a cover, a label describing the hazard shall be attached to the cover itself or adjacent to the cover. Opening or removing the cover shall neither remove nor visually obstruct the label (see paragraph 12.16.1; same as paragraph 6.6.6.2 for cases).
- **6.5.10.3 Instructional labels.** If instructions are provided regarding maintenance tasks, components, test points or service points inside the opening, they shall be attached to the cover itself or to the equipment adjacent to the cover so that the instructions remain visible when the cover is opened. These instructions shall be oriented horizontally with respect to the maintainer (same as paragraph 6.6.6.3 for cases).

## 6.6 Cases

This section contains criteria and guidelines regarding the size, mounts, fasteners, interlocks, and labels for cases.

**Definition.** A **case** is the part of a unit of equipment that encloses and protects the equipment from its surroundings. It may also serve to protect the surroundings - including maintainers - from the equipment.

### 6.6.1 General

- **6.6.1.1 Lift case, not equipment.** The case for a unit of equipment shall be designed so that the case is lifted off the equipment, not so that the equipment is lifted out of the case.
- **6.6.1.2 Ease of removal and replacement.** Cases shall be easy to open, remove, and replace.
- **6.6.1.3 Accessibility.** Cases shall be designed so that they can be opened, removed, and replaced without dismantling the equipment or associated equipment and items.
- **6.6.1.4 Minimizing need for removal.** Cases and equipment should be designed to minimize the need to remove the case.

**Example.** Adjustment controls, test points, and service points might be made accessible without requiring opening or removing the case.

- **6.6.1.5 Accessibility upon opening or removal.** Cases and units of equipment shall be designed so that when a case is opened or

removed, all portions of the equipment that are relevant to the maintenance task are accessible. The opened case shall not obscure or interfere with any controls, displays, test points, service points, or connections relevant to the maintenance task.

- **6.6.1.6 Handles or grips.** If a case is heavy or difficult to open, remove, or replace, it shall have appropriate handles, grasping areas, lifting eyes, or other lifting aids.
- **6.6.1.7 Rounded edges.** The corners and edges of cases shall be smooth and rounded so that they do not injure the maintainer or damage his or her clothing (see paragraph 12.5.1.4; same as paragraph 6.5.1.8 for covers).

## 6.6.2 Size

The primary determinant of the size of a case is the size of the equipment it encloses. Some additional criteria for case size are given in this section.

- **6.6.2.1 Precise movements not required.** Cases shall be sufficiently larger than the items they cover so that they can be opened, removed, and replaced without requiring precise movements on the part of the maintainer.
- **6.6.2.2 Clearance between case and components.** Cases shall be large enough that they do not damage internal wiring or components when they are opened, removed, or replaced.

## 6.6.3 Mounting

- **6.6.3.1 Alignment aids.** If a case is heavy or awkward to handle, or if it encloses delicate, sensitive components, the case or the equipment shall have guide pins, tracks, or some other alignment device to help guide the case while it is being opened, removed, or replaced.
- **6.6.3.2 Sealing material.** If the equipment design includes sealing material between the case and the base to which it is attached, the sealing material and its mounting method shall be selected so that the material is not damaged while the case is being opened, removed, or replaced.
- **6.6.3.3 Stops and retainers.** If a case is attached by hinges, it shall have stops or retainers that prevent it from swinging into or dropping onto other equipment or maintainers.
- **6.6.3.4 Supports.** If a case is attached by hinges, it shall have a stop or support to hold it in the open position, that is, the maintainer shall not have to support the case.
- **6.6.3.5 Fastened-unfastened indication.** Cases shall be designed or mounted so that it is clear whether or not they are fastened when they are in their closed position (same as paragraph 6.5.1.3 for covers).

**Example.** Cases might be spring loaded so that they stay open when they are not fastened.

## 6.6.4 Fasteners

- **6.6.4.1 Fastener security.** Fasteners shall hold cases securely in their operating environment, for example, withstanding the effects of vibration, wind gusts, and pressure (same as paragraphs 6.5.8.1 for covers and 6.7.1.1 for fasteners).
- **6.6.4.2 Number and ease of opening.** The fasteners for a given case shall be the fewest in number and the simplest to operate that meet the closure, structural, and ease of maintenance requirements for the case (see also paragraph 6.5.1.2; same as paragraph 6.5.8.2 for covers and 6.7.1.2 for fasteners).
- **6.6.4.3 Common fasteners.** The fasteners for a given case shall be interchangeable with the fasteners for other cases on the same equipment and with fasteners for similar cases on other equipment (same as paragraph 6.5.8.3 for covers and 6.7.1.3 for fasteners).
- **6.6.4.4 Captive fasteners.** Captive fasteners should be used for cases (same as paragraph 6.5.8.4 for covers).
- **6.6.4.5 Quick-action fasteners.** Fasteners for cases should be of the quick-action type, requiring only part of a turn or a snap action to fasten and unfasten (same as paragraph 6.5.8.5 for covers).
- **6.6.4.6 Self-alignment.** Fasteners for cases shall be selected or designed so that they are easily aligned with their retaining catches, nuts, blocks, or inserts. This alignment shall occur without binding and without damage to fastener threads or receptacles (same as paragraph 6.5.8.6 for covers and 6.7.1.4 for fasteners).
- **6.6.4.7 Operable by hand or common hand tools.** Fasteners shall be operable by hand if possible; otherwise, by common hand tools (same as paragraph 6.5.8.7 for covers and 6.7.1.5 for fasteners).
- **6.6.4.8 Opened-closed indication.** Fasteners should give a clear indication that they are open (unfastened) or closed (fastened) (same as paragraph 6.5.8.8 for covers and 6.7.1.6 for fasteners).
- **6.6.4.9 Hole size.** The holes in cases through which fasteners pass shall be large enough to permit inserting or "starting" the fasteners even when the case is not perfectly aligned (same as paragraph 6.5.8.9 for covers and 6.7.1.7 for fasteners).

## 6.6.5 Interlocks

Definitions for interlocks, lockouts, and tagouts are provided in section 6.5.9.

- **6.6.5.1 Protection from hazards.** If a hazardous condition (such as a high voltage or moving parts) exists inside a case, the case shall have an interlock that disables the hazard when the case is opened or removed (see paragraphs 12.4.1.9 and 12.4.1.10; same as paragraph 6.5.9.1 for covers).

Human protection from hazardous conditions with unexpected energization or release of stored energy is treated in 29 CFR 1910.301 -308, 331 -335, and 399. The OSHA regulation 29 CFR 1910.333 (B) (2) (iii) requires the simultaneous use of both tagout and lockout in the workplace; 29 CFR 1910.333 (b) (2) (ii) (B) states that interlocks shall not be the sole means of de-energizing circuits of equipment and are not substitutes for lockout and tagout procedures and practice (see paragraph 12.4.1.11).

- **6.6.5.2 Interlock override switch.** If a task requires that a maintainer work on hazardous equipment that is equipped with a disabling interlock, the equipment shall have an interlock override switch that permits manual bypassing or overriding of the interlock when the case is open. This override switch shall automatically reset to the non-by-pass position which is the safe operating position when the case is replaced (same as paragraphs 6.5.9.2 for covers and 12.4.1.11). OSHA 29 CFR 1910.333 requires that only qualified personnel shall be allowed to disable an interlock.
- **6.6.5.3 Labeling cases with interlocks.** If a case has an interlock, a label stating the presence of both the hazard and the interlock shall be placed on the equipment or the case so that it is visible both when the case is in place and when it is open or removed (same as paragraphs 6.5.9.3 for covers).

## 6.6.6 Labeling and marking

- **6.6.6.1 Method of opening.** If the method for opening a case is not obvious, a label with opening instructions shall be attached to the outside of the case itself or adjacent to the case (same as paragraph 6.5.10.1 for covers).
- **6.6.6.2 Hazard labels.** If a hazardous condition exists inside a case, a label describing the hazard shall be attached to the case itself or adjacent to the case. Opening or removing the case shall neither remove nor visually obstruct the label (see also paragraph 12.16.1; same as paragraph 6.5.10.2 for covers).
- **6.6.6.3 Instructional labels.** If instructions are provided regarding maintenance tasks, components, test points, or service points inside a case, they shall be attached to the case itself or adjacent to the case so that the instructions remain visible when the case is opened. These instructions shall be oriented horizontally with respect to the maintainer (same as paragraph 6.5.10.3 for covers).

## 6.7 Fasteners

This section contains general criteria and guidelines for fasteners and specific criteria and guidelines for nuts and bolts, screws, the heads of bolts and screws, latches and catches, and other fastening devices. Additional criteria and guidelines are provided for quick fastening and releasing devices, captive fasteners, and the labeling and marking of fasteners.

**Definition. Fasteners** are devices that join, attach, and mount parts, components, cases, covers, and units of equipment. They include quick fastening and releasing devices, screws, bolts, latches, catches, rivets, retainer rings, and retainer chains.

Fasteners are available in a wide variety of types and sizes, and new types appear frequently. Designers are advised to review the varieties available before selecting fasteners for a particular application. Factors influencing the choice of a fastener for a particular application include: (1) the stress and environmental factors the fastener must withstand, (2) the tools and clearance required to fasten and release the fastener, (3) the frequency with which the fastener will be fastened and released, (4) the speed with which the fastener must be fastened and released, (5) the types and varieties of other fasteners used in that and related applications, and (6) the clothing, especially gloves or mittens, the maintainer may be expected to wear.

### 6.7.1 General

- **6.7.1.1 Fastener security.** Fasteners shall hold securely in their operating environment, for example, withstanding the effects of vibration, wind gusts, and pressure (same as paragraphs 6.5.8.1 for covers and 6.6.4.1 for cases).
- **6.7.1.2 Number and ease of opening.** The fasteners for a given application shall be the fewest in number and the simplest to operate that meet the closure, structural, and ease of maintenance requirements for the application (same as paragraphs 6.5.8.2 for covers and 6.6.4.2 for cases).
- **6.7.1.3 Common fasteners.** To the extent possible, fasteners shall be interchangeable throughout a given application (see paragraphs 6.5.8.3 for covers and 6.6.4.3 for cases).
- **6.7.1.4 Self-alignment.** Fasteners shall be selected or designed so that they are easily aligned with their retaining catches, nuts, blocks, or inserts. This alignment shall occur without binding and without damage to fastener threads or receptacles (same as paragraphs 6.5.8.6 for covers and 6.6.4.6 for cases).
- **6.7.1.5 Operable by hand or common hand tools.** Fasteners shall be operable by hand if possible; otherwise, by common hand tools (same as paragraphs 6.5.8.7 for covers and 6.6.4.7 for cases).



- **6.7.1.6 Open-closed indication.** Fasteners should give a clear indication that they are open (unfastened) or closed (fastened) (same as paragraphs 6.5.8.8 for covers and 6.6.4.8 for cases).
- **6.7.1.7 Hole size.** The holes through which fasteners pass shall be large enough to permit inserting or "starting" the fasteners even when parts are not perfectly aligned (same as paragraphs 6.5.8.9 for covers and 6.6.4.9 for cases).
- **6.7.1.8 Fastener variety.** The variety of fasteners used in a particular application (that is, the number of different types and sizes) shall be the minimum that meets the requirements for closure, structure, and ease of maintenance. These requirements include such aspects as stress, bonding, pressure, temperature, and shielding.

**Discussion.** Minimizing the variety of fasteners simplifies the stocking of spare parts and reduces the danger that maintainers will damage fasteners or equipment by using the wrong tool or the wrong fastener.

- **6.7.1.9 When different fasteners are required.** If removal or insertion of a wrong fastener could result in damage to equipment or a change in calibration settings, distinguishably different fasteners shall be used.
- **6.7.1.10 Different fasteners must be distinguishable.** If more than one type of fastener is required for a unit of equipment:
  - a. The different types shall be easily distinguishable from each other, for example, screws with different threads might also be different in physical size.
  - b. The fastener-receptacle interface shall permit the maintainer to distinguish the intended location of each fastener easily.
- **6.7.1.11 Location of fasteners.** Fasteners shall be located so that they:
  - a. are easily accessible to the maintainer without requiring the removal of other parts or units,
  - b. can be operated with little or no interference from other structures,
  - c. do not interfere with each other or with other components,
  - d. are not hazardous to maintainers or potentially damaging to wires or hoses, and
  - e. have adequate clearance to permit easy hand or tool operation.

- **6.7.1.12 Strength of hand-operated fasteners.** Fasteners that are normally operated by hand shall be strong enough to withstand being operated with a tool.
- **6.7.1.13 Painted or coated fasteners.** If fasteners are painted or coated, the paint or coating shall not adversely affect their removal or installation.
- **6.7.1.14 Precise torque requirements.** Equipment should be designed so that precise torque on fasteners is not required. If it is required, fasteners that incorporate torque indications should be used.

**Examples.** Some examples of fasteners that incorporate torque indications are: (1) nuts that break away, (2) crushable washers that give a visual indication that correct torque has been reached, and (3) tools that crimp the nut and achieve the correct torque.

- **6.7.1.15 Torqued fasteners.** If a precise torque is required, the fastener shall be located so that the torquing tool can be applied directly, without the use of irregular extensions.

## 6.7.2 Number

- **6.7.2.1 Minimum that meets requirements.** The number of fasteners used in a particular application shall be the minimum number that meets the closure, structural, and ease of maintenance requirements. A few large fasteners are preferable to many small fasteners as long as they meet the requirements.
- **6.7.2.2 Mounting.** No more than four fasteners should be used to mount a unit of equipment.
- **6.7.2.3 Minimize by using hinges, catches, latches, and quick fastening and releasing devices.** Hinges, catches, latches, and quick fastening and releasing devices should be used to reduce the number of fasteners whenever they meet the other relevant requirements.
- **6.7.2.4 Minimize by using tongue-and-slot design.** Tongue-and-slot design should be used whenever possible in covers and cases to minimize the number of fasteners.

## 6.7.3 Types

This section lists criteria and guidelines for different types of fasteners. For ease of maintenance, the order of preference by type is: (1) quick fastening and releasing devices, (2) latches and catches, (3) captive fasteners, (4) screws, and (5) nuts and bolts.

### 6.7.3.1 Nuts and bolts

Nuts and bolts are relatively time consuming to install and remove. The maintainer usually has to have access to both ends of the bolt, to use both hands, and to make fairly precise movements in starting the nut. Often the maintainer has to use two tools, one for the bolt and one for the nut. The inclusion of

washers increases the number of parts to handle and possibly lose.

- **6.7.3.1.1 Bolt length.** Bolts shall be no longer than necessary for their given application. If a nut is used, at least two threads of the bolt shall extend beyond the nut when the nut is tightened.
- **6.7.3.1.2 Bolt threads.** The bolt threads should be no finer than strength requirements dictate.
- **6.7.3.1.3 Turns to tighten.** The number of turns to tighten a bolt should be less than ten.
- **6.7.3.1.4 Hexagonal nuts.** Hexagonal nuts shall be used in high-torque applications.
- **6.7.3.1.5 Wing and knurled nuts.** Wing nuts or knurled nuts should be used in low-torque applications.
- **6.7.3.1.6 Left-hand threads.** Left-hand threaded nuts and bolts shall be used only when conditions require them, for example to prevent loosening due to rotation. When used, they shall be coded by marking, shape, or color so that they are easily distinguishable from right-hand threaded nuts and bolts.
- **6.7.3.1.7 Lock washers.** Lock washers or other restraining measures shall be used to prevent nuts and bolts from loosening under vibration.
- **6.7.3.1.8 Removal and replacement with one hand or tool.** Nuts and bolts that are removed and replaced frequently or that are relatively inaccessible should be mounted so that they can be removed and replaced with one hand or one tool. A recess should be provided to hold either the bolt or the nut.
- **6.7.3.1.9 Bolt mounting.** Bolts should be mounted with their heads up so that they remain in position if the nut falls off.

### 6.7.3.2 Screws

Screws are relatively time consuming to insert and remove, and their threads and slots are susceptible to damage. However, screwdrivers usually require less operating space than wrenches, and they usually require the use of only one hand. In addition, screws are usually used alone, as opposed to bolts, which are usually used in combination with washers and nuts.

- **6.7.3.2.1 Number of turns.** The number of turns to tighten or loosen a screw should be less than ten.
- **6.7.3.2.2 Slot depth.** Screw heads should have deep slots that will resist damage.
- **6.7.3.2.3 "Straight-in" screwdriver orientation.** Screws shall be used only when screwdrivers can be used in a "straight-in" orientation; the use of offset screwdrivers shall not be required.

- **6.7.3.2.4 Blind operation.** If a screw must be operated in a position in which the maintainer cannot see its head, a guide shall be provided to help position the screwdriver.

**Example.** The screw might be located at the bottom of a cylindrical hole so that the hole guides the screwdriver to the screw head.

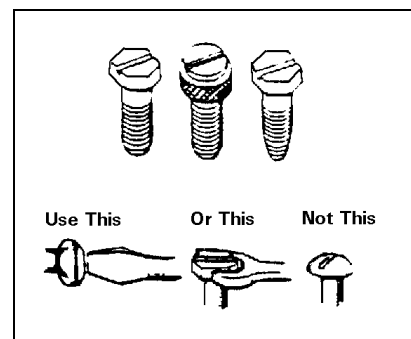
- **6.7.3.2.5 Screws for pressurized enclosures.** Fine-thread screws should be used for pressurized units.
- **6.7.3.2.6 Countersunk screws.** Screws should be countersunk when a smooth surface is required.
- **6.7.3.2.7 Screws for thin panels.** Flat-head screws should not be used on panels less than 2.4 mm (3/32 in) thick.
- **6.7.3.2.8 Self-tapping screws.** If a unit of equipment requires more than one size of self-tapping screw, the different sizes shall be kept to a minimum, and they shall all have the same type of head.

### 6.7.3.3 Screw and bolt heads

Combination-head bolts and screws are preferable to other bolts and screws since they allow operation with both wrenches and screwdrivers. Slotted hexagonal heads are preferable to slotted knurled heads. Combination-head bolts and screws reduce the likelihood of damaged slots and stuck fasteners.

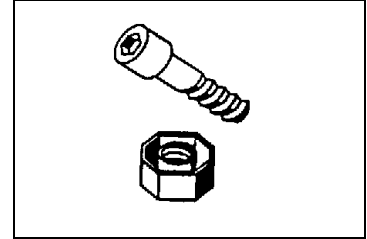
- **6.7.3.3.1 Same heads for screws and bolts.** To the extent possible, all bolts and screws on a given unit of equipment shall have the same size and type of head so that maintainers can operate all of them with a single tool.
- **6.7.3.3.2 Combination-head bolts and screws.** Combination-head bolts and screws should be used, preferably those having slotted, hexagonal heads. Exhibit 6.7.3.3.2 shows examples of combination-head bolts and screws; the combinations illustrated are slotted-hexagonal and slotted-knurled.
- **6.7.3.3.3 Straight-slot and cross-recess type internal fasteners.** Noncombination straight-slot or cross-recess type internal fasteners shall not be used except to fasten wood.

**Exhibit 6.7.3.3.2** Examples of combination-head bolts and screws



- **6.7.3.3.4 Internal-wrenching fasteners -- where to use.** Internal-wrenching fasteners shall not be used except where a flat, smooth surface is required and where the fasteners are protected from the accumulation of foreign material such as dirt, ice, or snow. Exhibit 6.7.3.3.4 shows an example of an internal-wrenching bolt and an internal-wrenching nut.

**Exhibit 6.7.3.3.4**  
Example of an  
internal-wrenching  
bolt and nut



- **6.7.3.3.5 Internal-wrenching fasteners slots.** If internal-wrenching fasteners are used, the slots should be deep enough so that the fastener is not damaged when it is operated. The fasteners should be located where they can be removed by the special tools required if a slot is damaged.
- **6.7.3.3.6 High-torque fasteners.** If a torque of more than 14 N·m (10 ft-lb) is required, fasteners shall have external hexagonal or double-hexagonal heads. If external-wrenching heads cannot meet functional or personnel safety requirements, or in situations in which the fastener is protected from accumulation of foreign material, internal-wrenching fasteners may be used.
- **6.7.3.3.7 Low-torque fasteners.** If a torque of less than 14 N·m (10 ft-lb) is required, fastener heads should be one of the following types: (1) combination-head, (2) hexagonal, external-grip head, (3) hexagonal internal-grip heads, or (4) Torq-set.

#### 6.7.3.4 Latches and catches

Latches and catches can be operated quickly and easily. They do not require the use of tools, and they have good holding power, but they cannot be used where smooth surfaces are required.

- **6.7.3.4.1 Positive catch.** Latches and catches shall have a positive catch.
- **6.7.3.4.2 Visual indication.** Latches and catches shall give a clear visual indication that the latch or catch is engaged.
- **6.7.3.4.3 Spring-loading of catches.** Catches should be spring-loaded so that they lock on contact rather than requiring some other action by the maintainer.
- **6.7.3.4.4 Nonhazardous.** The spring action or snap-down force in a catch or latch shall not be so strong that it could injure the maintainer (see also paragraph 12.3.5).
- **6.7.3.4.5 Associated handles.** If a latch or catch is associated with a handle, the release mechanism for the latch or catch shall be located on or near the handle so that release and opening can be accomplished with one hand.

**6.7.3.5 Other fastening devices**

- **6.7.3.4.6 Preventing inadvertent operation.** Latches and catches shall be located and positioned so that it is not likely that they will be operated inadvertently under normal operating conditions.

This section gives criteria and guidelines for a variety of additional fastening devices, including cotter pins and keys, retainer rings, safety wire, rivets, retainer chains, and washers.

- **6.7.3.5.1 Integral fasteners not allowed.** Fasteners shall not be an integral part of the equipment's housing; studs are an example of disallowed integral fasteners.
- **6.7.3.5.2 Cotter pins and keys.** Guidelines for cotter pins and keys are:
  - a. Pins and keys should fit snugly, but not so tightly that they cannot be slid in and out by hand.
  - b. The heads of cotter keys should be large enough so that they do not slip through the hole and so that they are easy to remove.
- **6.7.3.5.3 Retainer rings.** Criteria for retainer rings are:
  - a. Retainer rings shall be easy to remove and replace when worn.
  - b. When possible, retainer rings shall lock into position with a positive snap.
  - c. Twist-to-lock retainer rings shall have spring tension to prevent their loosening.
- **6.7.3.5.4 Pin-and-hook fasteners.** If a cover must have the ability to survive nuclear, biological and chemical hazards, it should be attached with pins and hooks rather than hinges (same as paragraph 6.5.8.11 for covers).
- **6.7.3.5.5 Safety wire.** Criteria for safety wire are:
  - a. Safety wire shall be used only when self-locking fasteners or fasteners with cotter pins are not adequate to withstand the expected vibration or stress.
  - b. When safety wire is used, it shall be easy to remove and replace.
  - c. If a visible means of detecting that a fastener has become loosened or has changed position is required, safety wire shall be used.
- **6.7.3.5.6 Rivets.** Rivets are permanent fasteners that are difficult and time consuming to remove and replace; they are not ordinarily used on parts that might require removal. Criteria for rivets are:

- a. Rivets shall not be used to attach hinges, latches, catches, or other quick fastening and releasing devices.
  - b. Rivets shall be of softer material than the pieces they fasten.
  - c. The holes for shear rivets shall be drilled to close tolerances. Maintenance instructions shall specify these tolerances and the sizes of plug gauges and reamers to be used.
- **6.7.3.5.7 Retainer chains.** Retainer chains or locking bars are used to: (1) keep hatches or doors from opening too far or from springing their hinges, (2) convert doors or covers into shelves for the maintainer, (3) prevent small covers or caps from being misplaced, (4) secure small, special tools at the location where they will be used, (5) secure objects that might otherwise fall and get lost, and (6) secure objects that might otherwise fall and injure the maintainer or damage the equipment. Guidelines for retainer chains are:
- a. Only link, sash, or woven-mesh type chains should be used. Bead-link chain should not be used; it is more breakable than other types.
  - b. Retainer chains should be attached with screws or bolts so that they can be disconnected easily if necessary.
  - c. Each end of a retainer chain should have an eyelet.
  - d. Retainer chains for filler caps should be attached externally, not internally.
  - e. Chains should not be used where they might interfere with moving parts.
  - f. If chain covers are required, they should be flexible and durable.
- **6.7.3.5.8 Washers.** Guidelines for washers are:
- a. Washers should fit tightly against the underside of the fastener head.
  - b. Washers should fit the shaft snugly, but should be easy to remove.
  - c. Split-ring washers should be used with static loads in excess of 55 g (2 oz).
  - d. Lock washers should be used with lock nuts for maximum locking action.

### 6.7.3.6 Quick fastening and releasing devices

Quick fastening and releasing devices are quick (by definition) and easy to use. They require no tools; they can be operated with only one hand; and they are good for securing plug-in

components, small components, and covers. However, they have relatively low holding power, and they cannot be used where a smooth surface is required.

- **6.7.3.6.1 Frequent access.** Quick fastening and releasing devices shall be used for components that must be dismantled or removed frequently.
- **6.7.3.6.2 Tools not required.** Quick fastening and releasing devices shall fasten and release easily without the use of tools.
- **6.7.3.6.3 Single motion.** Quick fastening and releasing devices shall operate with a single motion of the hand, for example, requiring no more than one complete revolution.
- **6.7.3.6.4 Visual indication of state.** Quick fastening and releasing devices shall give a clear visual indication that they are fastened or released.
- **6.7.3.6.5 Minimum turns.** Wherever bolts or screws are used, they shall be selected so that fastening them requires only the minimum number of turns necessary to meet the closure and structural requirements of the application.

**Discussion.** Bolts and screws requiring more than the minimum number of turns may be excepted from this rule if they are used to reduce the variety of fasteners in a unit of equipment (see paragraph 6.7.1.8).

### 6.7.3.7 Captive versus removable

Captive fasteners can be time consuming and difficult to operate. They usually require the use of a tool, but the tool can usually be operated with one hand. The fasteners stay in place, thus saving handling time and avoiding the possible loss of parts.

- **6.7.3.7.1 When to use.** Captive fasteners shall be used whenever dropping a fastener or a related part, such as a washer or bolt, might cause damage or excessive loss of time.
- **6.7.3.7.2 Operation and replacement.** Captive fasteners shall be operable by hand or with common hand tools, and they shall be easily replaceable if damaged.
- **6.7.3.7.3 "Quarter-turn" fasteners.** If "quarter-turn" type fasteners are used, they shall be self-locking and spring-loaded.
- **6.7.3.7.4 Access covers.** Access covers that are removed frequently should have captive fasteners (see paragraph 6.5.8.4 for covers).
- **6.7.3.7.5 Small removable pins, caps, and covers.** Small removable pins, caps, and covers should be attached, probably with a retainer chain, so that they are not lost or dropped into the equipment.
- **6.7.3.7.6 Mounting bolts.** Mounting bolts should be semi-permanently captive, perhaps by means of "snap-on" collars.



### 6.7.4 Labeling, marking, and coding

- **6.7.4.1 Mounting bolts.** Bolts that mount units of equipment should be color coded or perhaps embossed with the letter "M" to distinguish them from other visible fasteners.
- **6.7.4.2 Fasteners requiring torquing.** Fasteners that require a precise torque should have labels on or near the fasteners stating the required torque value and the torquing sequence.
- **6.7.4.3 Durability of marking.** If fasteners are marked or coded, the marks or codes shall withstand exposure to any chemicals, fuels, weather, or other adverse conditions in their ambient environment.
- **6.7.4.4 Consistent coding.** If a coding system for fasteners is used, it shall be consistent throughout a unit of equipment and for similar or related units of equipment.

## 6.8 Connectors

This section contains criteria and guidelines for various types of connectors (plug-in, threaded, and quick-action), for the location and accessibility of connectors, and for alignment aids. It also contains criteria and guidelines specific to electrical connectors and to fluid and gas connectors, including criteria and guidelines for their labeling and marking.

**Definition.** A **connector** is a piece of hardware that joins or attaches lines or cables to other lines or cables or to units of equipment. The term is used rather loosely to refer to either of the two parts that mate with each other and to the plug that mates with a receptacle.

### 6.8.1 General

- **6.8.1.1 Fast, easy operation.** Connectors shall be selected or designed to permit fast, easy maintenance operations, including such tasks as testing, servicing, removing, and replacing units of equipment and components.
- **6.8.1.2 Safety.** Connectors shall be selected or designed to ensure the safety of maintainers and equipment from pressures, contents, or voltages, during the release of connectors (see paragraph 12.6.2).
- **6.8.1.3 Hand or common tool operation.** Connectors shall be selected or designed to permit operation by hand or by common hand tools.
- **6.8.1.4 Compatibility.** Connectors shall be selected or designed to be compatible with their associated lines and cables, fasteners, mounting, environmental extremes, and maintenance routines.

- **6.8.1.5 Protection of connectors.** If a connector is susceptible to damage, it shall be protected by one or more of the following measures: (1) recessing the receptacle, (2) recessing delicate parts such as pins and keys within the connector, and (3) providing a protective cap, insert, cover, case, or shield.
- **6.8.1.6 Captive covers.** If a connector has a protective cover, the cover shall be of the captive type.

## 6.8.2 Types

### 6.8.2.1 Distinctive

- **6.8.2.1.1 Distinctive types.** Connectors for lines serving different functions, for example, fuel lines and water lines, or electrical power lines and radio-frequency signal lines, shall be distinctively different and physically incompatible (same as paragraph 12.6.2).
- **6.8.2.1.2 Preventing mismatching.** Connectors serving the same or similar functions shall be selected or designed to minimize the likelihood of mismatching.

**Discussion.** Preferably this will be accomplished by making the connectors physically incompatible, for example, by using connectors of different sizes or by using alignment pins or keys. If that is not feasible, coding by color may be acceptable.

### 6.8.2.2 Plug-in

Plug-in connectors are the easiest and least time consuming to use, but they have low holding power. They are particularly convenient where frequent connection and disconnection is required.

- **6.8.2.2.1 When to use.** If a line or cable is likely to be connected and disconnected frequently, and if the line or cable is not likely to be pulled accidentally, plug-in connectors should be used.
- **6.8.2.2.2 Preventing damage.** Plug-in connectors and their receptacles shall be selected or designed so that the plug cannot be inserted into a receptacle that it does not match. An attempt to insert a plug into a nonmatching receptacle shall damage neither the plug nor the receptacle.

### 6.8.2.3 Threaded

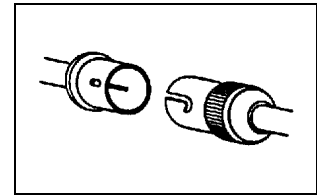
Threaded connectors provide very secure connections, particularly when locked in place with set screws, retainers, or safety wires. They are more time consuming to connect and disconnect than plug-in connectors.

- **6.8.2.3.1 Ease of operation.** Threaded connectors shall be selected or designed so that they meet the holding requirements for the connection with a minimum number of turns.

### 6.8.2.4 Quick-action

Quick-action connectors are, as their name implies, quick and easy to use. They include connectors that operate in one of the following ways; (1) by a snap action, (2) by rotating the connector up to one complete turn, (3) by triggering a latch or spring device, and (4) by removal of an external pin. Exhibit 6.8.2.4 illustrates a common type of quick-action connector, one that operates with a quarter-turn rotation.

**Exhibit 6.8.2.4**  
Example of a quick-action connector



- **6.8.2.4.1 When to use.** Quick-action connectors shall be used when units of equipment or components must be connected or disconnected frequently or when connection and disconnection must be completed quickly, provided that they meet all other requirements for the connection, such as holding or sealing.
- **6.8.2.4.2 Self-locking.** Quick-action connectors shall have self-locking catches that prevent loosening and ensure a secure connection.

### 6.8.3 Location and accessibility

- **6.8.3.1 Visual and physical access.** Connectors shall be located so that maintainers can see, reach, connect, and disconnect them easily and safely.
- **6.8.3.2 Unobstructed access.** Connectors shall be located so that they can be seen and reached without the disassembly or removal of other equipment or components.
- **6.8.3.3 Relative accessibility.** The connectors that are connected and disconnected most frequently shall be the most accessible.
- **6.8.3.4 Full access.** The rear of plug connectors shall be accessible for testing and servicing.
- **6.8.3.5 Protected from dislodging and damage.** Connectors shall be located so that they are not dislodged or damaged by the movement of people or objects in their vicinity.
- **6.8.3.6 Minimum spacing.** The space between a connector and any other connector or obstruction shall be sufficient to permit the connector to be grasped as firmly as necessary for connecting and disconnecting it. This spacing shall be at least:
  - a. 25 mm (1 in) if the connector is operated with bare fingers,
  - b. 32 mm (1.25 in) if the connector is operated with gloved fingers,

- c. 64 mm (2.5 in) if the connector must be "gripped firmly," and
- d. 75 mm (3 in) if the connector is operated with mittened hands.

Clearance shall be measured from the outermost portion of the connector, that is, from the backshell, strain relief clamp, dust cover, or electromagnetic interference shield or radio frequency interference shield, if they exist, and it shall permit a rotation of at least 270°.

- **6.8.3.7 Space for wrench.** If the connector requires high torque, there shall be enough space around it to permit use of a wrench.

## 6.8.4 Alignment aids

- **6.8.4.1 Preventing misalignment.** Wherever a particular orientation of a connector is required, the connector and its receptacle shall be provided with an aligning device, such as a pin or key way, that prevents the connector from being inserted in any but the correct orientation.

**Discussion.** Even when an alignment device is provided, care must be taken to ensure that the connector is not symmetric, which would permit connection 180° from the correct orientation.

- **6.8.4.2 Alignment before contact.** Alignment devices shall ensure that correct alignment is achieved before electrical contact is made (same as paragraph 6.8.5.1.3).
- **6.8.4.3 Aligning the alignment devices.** If a unit of equipment has more than one connector having the same sort of alignment device, all of those connectors shall be oriented so that the alignment device is in the same relative position. For example, all alignment keys might be at the top.
- **6.8.4.4 Alignment coding.** If a connector has an alignment device, the connector shall be durably marked or coded to show the position of the alignment device. Methods for marking or coding include painted stripes and arrows (same as paragraph 6.8.8.11).
- **6.8.4.5 Alignment of drawer connectors.** If a module or unit of equipment is mounted in a drawer with a connector at the back that mates with a connector in the rack, guide pins or other alignment devices shall be provided to ensure proper mating.

## 6.8.5 Electrical connections

### 6.8.5.1 Plugs and receptacles

- **6.8.5.1.1 Fast, easy connection.** Unless precluded by other requirements, electrical connectors should be of the plug-in or quick-action types.
- **6.8.5.1.2 Prevention of insertion errors.** Electrical plugs shall be selected or designed so that it is physically impossible to insert a plug in the wrong receptacle or to insert it into a receptacle the wrong way. Some ways in which this can be accomplished are:
  - a. Use plugs with polarized prongs or prongs of different sizes,
  - b. Use plugs having different numbers of pins or different configurations of pins, and
  - c. Use plugs of different sizes.
- **6.8.5.1.3 Alignment before contact.** Alignment devices shall ensure that correct alignment is achieved before electrical contact is made (same as paragraph 6.8.4.2).
- **6.8.5.1.4 Few plugs, many contacts.** Where applicable, electrical connections shall be accomplished by using few connectors with many contacts rather than many connectors with few contacts.
- **6.8.5.1.5 "Hot" leads.** Wiring shall be routed through plugs and receptacles so that "hot" leads are not exposed in either the plug or the receptacle when they are disconnected (same as paragraph 12.4.1.17).
- **6.8.5.1.6 "Cold" plugs.** Wiring shall be routed so that receptacles are "hot," and plugs are "cold" when they are disconnected.
- **6.8.5.1.7 Electrical charges.** Disconnected plugs and leads shall not expose maintainers to stored electrical charges.
- **6.8.5.1.8 Self-locking or latching.** Electrical connectors should be self-locking or should have safety catches; they should not require safety wire.
- **6.8.5.1.9 Insertion force.** Electrical connectors should require low insertion forces to minimize the possibility of damaging the connector or injuring the maintainer.
- **6.8.5.1.10 Durability.** Plugs and pins shall be selected or designed to withstand rough use.

- **6.8.5.1.11 Nonshorting contacts.** Connectors shall be selected or designed so that electrical contacts cannot be shorted by external objects.
- **6.8.5.1.12 Pin identification.** Each pin on each plug shall be clearly identified or coded, using labels or color or shape coding.
- **6.8.5.1.13 Test points.** If test points are required to measure inputs or outputs that cannot be easily checked otherwise, they should be provided: (1) on the plug itself, or (2) on an adapter that can be inserted between the plug and the receptacle (see paragraph 6.14.4.4 for additional information and exhibits 6.14.4.4 (a) and (b) for illustrations of a plug with test points and an adaptor with test points, respectively).
- **6.8.5.1.14 Disassembly by hand or using common hand tools.** The disassembly of connectors to change pin connections should not require the use of special tools; it should be possible by hand or with the use of common hand tools.
- **6.8.5.1.15 Drawer module connectors.** Units of equipment that are mounted in drawers and that do not require that connections be maintained when the drawer is extended, shall be provided with plugs mounted on the back of the drawer. These plugs shall have alignment guides that allow the unit to be slid back into place and mate with receptacles in the cabinet to accomplish whatever electrical interconnections among the drawer, other equipment in the cabinet, and external connections are required.

## 6.8.5.2 Wire connections

This section contains criteria and guidelines governing the arrangement and attachment of individual wires. Lugs and crimp-on devices are preferable to wire-wrap, pig tailing, and soldering for connecting or splicing individual wires. Soldering provides the most secure connection, but it is also the most time-consuming.

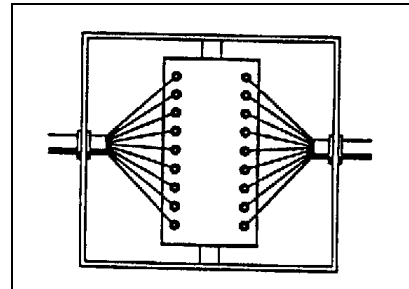
- **6.8.5.2.1 Length of leads.** Leads shall be as short as possible but long enough to allow all of the following that apply (same as paragraph 6.9.1.2.5):
  - a. easy connection and disconnection, with enough slack to back the wire away from the point of attachment to facilitate removal of the unit,
  - b. sufficient slack for at least two (preferably six) replacements of terminal fittings, electrical considerations permitting,
  - c. movements of parts to which they may be attached (doors, covers, and the like) without undue stress or bending,
  - d. connection, disconnection, or movement without requiring a bending radius of less than six times the diameter of the lead, and

- e. movement of units that are difficult to handle in their mounted position to a more convenient position for connection or disconnection.

- **6.8.5.2.2 Spacing of leads.** It shall be easy for maintainers to perform any necessary operations on leads, in particular connecting and disconnecting them. This may be accomplished by adequate spacing of the terminals to which they are attached (see paragraph 6.8.5.2.9), or by ensuring that the leads are long enough that they can be separated by the maintainer (see paragraph 6.8.5.2.1).

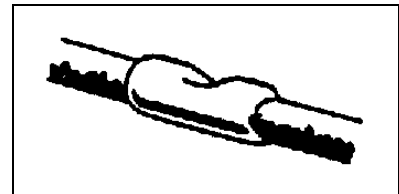
- **6.8.5.2.3 Cable "fan out."** The wires in cables shall "fan out," see exhibit 6.8.5.2.3, so that the individual wires can be attached to junction boxes, terminal blocks, or other mounts. Each attachment point shall be easily identifiable and easy to reach with test probes (same as paragraph 6.9.1.1.5).

**Exhibit 6.8.5.2.3** Fanning out cables



- **6.8.5.2.4 Extra wire length.** If wires terminate in lugs or crimp-on devices, the wires shall be long enough to permit at least six replacements of the devices. Exhibit 6.8.5.2.4 illustrates an example of a crimp-on splice.

**Exhibit 6.8.5.2.4** Example of a crimp-on splice

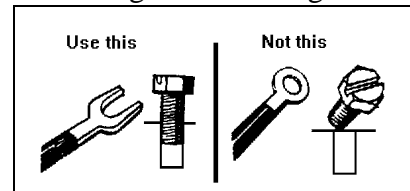


- **6.8.5.2.5 Clamping insulation.** Lugs and crimp-on devices shall clamp the insulation as well as the conductor.

- **6.8.5.2.6 Compatibility of lugs with terminals.** Lugs shall be compatible with terminal post requirements.

- **6.8.5.2.7 U-lugs.** U-lugs should be used rather than O-lugs (or eye lugs). Exhibit 6.8.5.2.7 illustrates a U-lug and an O-lug.

**Exhibit 6.8.5.2.7** Examples of a U-lug and an O-lug



- **6.8.5.2.8 Soldered connections.** Soldered connections shall be compatible with terminal post requirements.

- **6.8.5.2.9 Spacing of terminals.** Terminals to which wires are to be soldered shall be far enough apart that work on one terminal does not damage neighboring terminals or nearby parts (same as paragraph 6.10.3.1.6).

- **6.8.5.2.10 Length of terminals.** Terminals or other connections to which wires are soldered shall be long enough that soldering does not damage anything nearby.
- **6.8.5.2.11 Soldered wires.** The end of a wire soldered to a terminal shall extend beyond the solder so that the wire will be easy to remove.
- **6.8.5.2.12 Wire wrapping or pig tailing.** Wire wrapping and pig tailing shall not be used unless authorized by the acquisition program office.

## 6.8.6 Fluid and gasline connections

- **6.8.6.1 Connectors for rigid lines.** Connectors for rigid fluid and gas lines shall be located and installed so that it is not necessary to back the lines off or remove other equipment or components to connect or disconnect the connectors (see paragraph 6.9.2.2.2).

**Discussion.** Protruding gaskets or seals might be susceptible to damage, and that damage might spread internally, destroying the seal. Tapered nylon or Teflon washers of appropriate size can be employed to prevent extrusion.

- **6.8.6.2 Draining and filling.** Fluid and gas line connectors shall be located and installed so that draining, filling, and other maintenance involving the connectors or lines can be accomplished without jacking up the equipment.
- **6.8.6.3 Leakage tests.** Fluid and gas line connectors shall be located and installed so that leakage tests can be performed easily and without danger to the maintainer or the equipment (see section 12.6).
- **6.8.6.4 Control of leakage and spillage.** Fluid and gas line connectors shall be selected or designed so that leakage and accidental spillage during connection and disconnection are prevented or controlled so that they do not injure maintainers or damage equipment (see section 12.6).
- **6.8.6.5 Exposure to noise and vibration.** Fluid and gas line connectors shall be located and installed so that maintenance activities involving them do not require that the maintainer be exposed to extreme noise, vibration, or other danger (see section 12.12).

## 6.8.7 Gaskets and seals

- **6.8.7.1 Replaceable, renewable gaskets and seals.** Gaskets and seals used in connectors for fluid and gas lines shall be selected and installed to be replaceable or to have renewable wearing



surfaces; it shall not be necessary to discard the connector when the seal is damaged or worn.

- **6.8.7.2 Repair and replacement of gaskets and seals.** Gaskets and seals used in connectors for fluid and gas lines shall be easily inserted and removed, without requiring the removal of other connector parts or the disassembly of other equipment.
- **6.8.7.3 Identifiability of gaskets and seals.** Part numbers for gaskets and seals used in connectors for fluid and gas lines shall be easily identifiable. This may be accomplished through labeling, coding, marking, or user documentation.
- **6.8.7.4 Life expectancy of gaskets and seals.** Job instructions shall state the life expectancy of gaskets and seals and recommend when they should be changed.
- **6.8.7.5 Prevent entrance of air.** If the entrance of air into a disconnected fluid or gas line would create a maintenance problem, as for example, in a hydraulic line, gaskets and seals used in connectors shall prevent the entrance of air when the line is disconnected.
- **6.8.7.6 Tightening to offset shrinkage.** If a gasket or seal used in a fluid or gas line connector is subject to shrinkage, the connector shall permit tightening to offset the shrinkage.
- **6.8.7.7 Visibility.** Gaskets and seals used in fluid and gas line connectors shall be visible after they are installed so that maintainers can see that the gasket or seal is present (same as paragraph 6.9.2.1.3).
- **6.8.7.8 Nonprotrusion.** Gaskets and seals used in fluid and gas connectors shall not protrude beyond the coupling (same as paragraph 6.9.2.1.4).

**Discussion.** Protruding gaskets or seals might be susceptible to damage, and that damage might spread internally, destroying the seal. Tapered nylon or Teflon washers of appropriate size can be employed to prevent extrusion.

### 6.8.8 Labeling, marking, and coding

Coding and identifying connectors and associated parts can expedite maintenance and troubleshooting procedures by keying the connectors to references in job instructions and by identifying replaceable parts for ordering. Labeling, marking and coding can also provide appropriate warnings and cautions.

- **6.8.8.1 Matching connectors or plugs and receptacles.** Each connector or plug and its corresponding connector or receptacle shall be labeled or coded so that the two parts are easily matched.
- **6.8.8.2 Noninterchangeable connectors.** Noninterchangeable connectors shall be labeled or coded so that they are clearly distinguishable. Coding methods include shape, size, and color.

- **6.8.8.3 Matching wires to terminals or pins.** Each wire in a connector or receptacle shall be clearly identified with its terminal post or pin.
- **6.8.8.4 Identification of terminals on terminal strips or blocks.** Terminals on terminal strips or blocks shall be identified on the terminal strip or block itself or on the chassis, adjacent to the terminals (same as paragraphs 6.9.1.8.3 and 6.10.5.8).
- **6.8.8.5 Visibility of codes and labels.** Labels or codes associated with connectors shall be located so that:
  - a. they are clearly visible during maintenance,
  - b. they are visible whether the connector is connected or disconnected, and
  - c. the connectors can be identified without disconnecting them.
- **6.8.8.6 Location of labels and codes -- connectors.** Labels and codes on connectors shall be located, in order of preference, (1) directly on the connector, (2) on plates permanently attached to the connector, or (3) on tabs or tapes attached to the connector.
- **6.8.8.7 Location of labels and codes -- receptacles.** Labels and codes for receptacles shall be located, in order of preference, (1) directly on the receptacle, (2) on the surface or panel immediately adjacent to the receptacle or, if it is recessed, adjacent to its access opening.
- **6.8.8.8 Consistency of labels and codes.** Labels and codes on connectors shall be consistent with labels and codes on associated items, such as pins, terminals, and receptacles.
- **6.8.8.9 Warnings and cautions.** If any hazard to maintainers or equipment exists in the connection or disconnection of a connector, the connector shall be labeled or coded with an appropriate warning or caution.
- **6.8.8.10 Marking electrical connections.** Marking adjacent to plugs, jacks and other electrical connectors shall identify the connected circuits to preclude cross connections.
- **6.8.8.11 Alignment coding.** If a connector has an alignment device, it shall be durably marked or coded to show the position of the alignment device. Methods for marking or coding include painted stripes and arrows (same as paragraph 6.8.4.4).

## 6.9 Lines and cables

General criteria and guidelines for lines and cables are given in this section. The routing and mounting of electrical cables (including extension and mock-up cables) and fluid and gas lines are covered, as well as their labeling and marking.

**Definitions.** A **cable** is a number of lines bound together within a single, permanent sheath. A **line** is any single length of pipe, wire, or tubing.

Lines and cables most often end in connectors, and some criteria and guidelines regarding connectors are also given in this section. See section 6.8 for detailed information pertaining to connectors.

## 6.9.1 Electrical

### 6.9.1.1 General

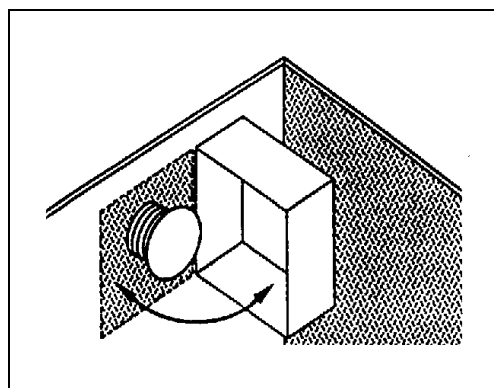
- **6.9.1.1.1 Selection.** Lines and cables shall be selected, designed, bound, mounted, and routed to:
  - a. preclude wear out, breakage, or damage,
  - b. facilitate logical and efficient divisions of maintenance responsibilities, and
  - c. allow maintainers to quickly and easily: (1) troubleshoot, test, check, and isolate malfunctions, (2) remove, repair, and replace other units of equipment and components, and (3) connect and disconnect lines and cables.
- **6.9.1.1.2 Insulation.** Clear plastic insulation should be used where possible to allow rapid detection of internal breaks.
- **6.9.1.1.3 Minimization.** Lines and cables should be designed to minimize the number of:
  - a. types and varieties of lines and cables,
  - b. different lengths of otherwise identical lines or cables, and
  - c. related connectors, fittings, and fixtures.
- **6.9.1.1.4 Quick-action connections.** When maintenance requires that cables be connected or disconnected easily or frequently, cables shall terminate in quick-action connectors.
- **6.9.1.1.5 Cable "fan out".** The wires in cables shall "fan out", (see exhibit 6.8.5.2.3) so that the individual wires can be attached to junction boxes, terminal blocks, or other mounts. Each attachment point shall be easily identifiable and easy to reach with test probes (same as paragraph 6.8.5.2.3).
- **6.9.1.1.6 Preformed cables.** Preformed cables should be used wherever possible to minimize wiring errors and allow for the use of more flexible and efficient assembly methods. Spare lines should be included to allow for growth and to speed wiring time as agreed upon by the acquisition agency.

- **6.9.1.1.7 Harnesses.** When harnesses are used they shall:
  - a. be designed, fabricated, and installed as units,
  - b. be held securely with lacing twine or other means acceptable to the user, and
  - c. keep the individual conductors essentially parallel, so they do not intertwine, though twisted pairs may be used when required.
- **6.9.1.1.8 Protection.** Shields or other protection shall be provided for easily damaged conductors such as waveguides, high-frequency cables, and insulated high-voltage cables.
- **6.9.1.1.9 Exposed cables.** Exposed cables shall be protected from mechanical damage. For example, armored cables might be used where damage is likely.
- **6.9.1.1.10 Special purpose cables.** Cables intended for use in the presence of nuclear, biological, or chemical hazards shall be sealed.
- **6.9.1.1.11 Insect protection.** If damage from termites is likely, line and cable insulation shall be protected by coating it with compounds of creosote, antimony, or other acceptable mixtures.
- **6.9.1.1.12 Fluid protection.** All electrical lines and cables shall be protected from oil, grease, fuel, hydraulic fluid, water or cleaning solvents. These may damage insulation and may result in injury to personnel.
- **6.9.1.1.13 Storage space.**

If long electrical cables are required for auxiliary power or test equipment, storage space shall be provided.

**Example.** Often, a storage compartment is present, but no easy means is provided for coiling the wire into a shape and size which will permit storage. A simple means of accomplishing this is a cable winder, a device around which the cable can be wrapped (see exhibit 6.9.1.1.13).

**Exhibit 6.9.1.1.13** Cable winders



- **6.9.1.1.14 Use of grommets.** When cables must pass over sharp edges, insulation shall be protected from fraying or other damage by grommets or equivalent means.

### 6.9.1.2 Length of cables and leads

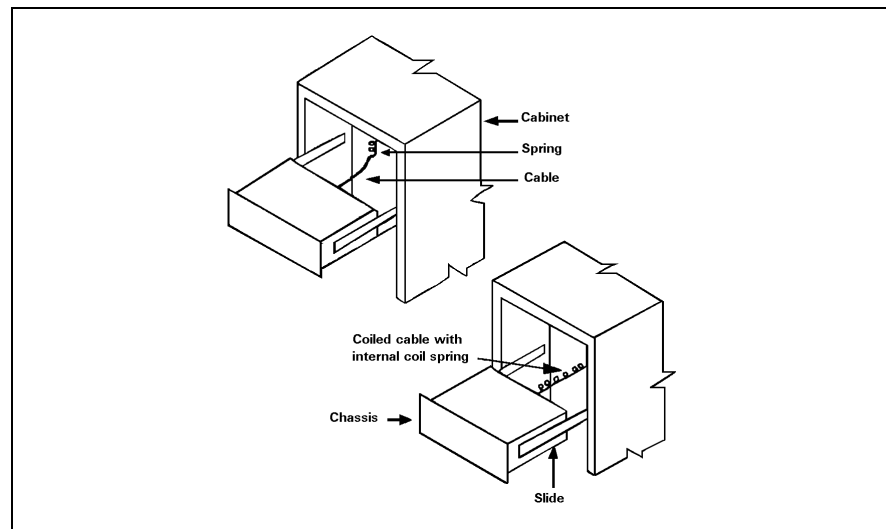
- **6.9.1.2.1 Length of cables.** If a circuit might be affected by differences in the length of a cable, the length of cables should be the same for each installation of a given type of electronic equipment.

**Discussion.** Even if a unit can be adjusted to compensate for differences in the length of the cable, using different lengths of cable means that an adjustment made on the bench might be out of tolerance when the unit is installed.

- **6.9.1.2.2 Extra cable.** Cables shall be long enough so that a unit of equipment can be moved to a convenient place for maintenance activities; extension cables shall be provided if necessary.
- **6.9.1.2.3 Accessibility.** Cables shall be long enough so that units of equipment mounted in drawers and on slide-out racks can be worked on without breaking electrical connections.
- **6.9.1.2.4 Cable length and connectors.** Cables shall be long enough so that connectors can be easily connected and disconnected.
- **6.9.1.2.5 Length of leads.** Lead lengths shall be as short as possible but long enough to allow all of the following that apply (see paragraph 6.8.5.2.1):
  - a. easy connection and disconnection, with enough slack to back the wire away from the point of attachment to facilitate removal of the unit,
  - b. sufficient slack for at least two (preferably six) replacements of terminal fittings, electrical considerations permitting,
  - c. movements of parts to which they may be attached (doors, covers, and the like) without undue stress or bending,
  - d. connection, disconnection, or movement without requiring a bending radius of less than six times the diameter of the lead, and
  - e. movement of the units which are difficult to handle in their mounted position to a more convenient position for connection or disconnection.
- **6.9.1.2.6 Slack.** Leads or cables to moving parts, doors, and covers shall have adequate slack and protection so that they:
  - a. permit movement, such as pulling out a drawer for maintenance, without breaking the electrical connection,
  - b. fold out of the way when the part is moved,

- c. are not pinched or otherwise damaged when the part is returned to its original position (see exhibit 6.9.1.2.6 for the use of springs and cable mechanisms to prevent pinching),

**Exhibit 6.9.1.2.6** Recoiling slack cable



- d. do not chafe or break under the repeated flexing required.

### 6.9.1.3 Routing and mounting

- **6.9.1.3.1 Routing considerations.** Lines and cables shall be routed so they will not be:
  - a. pinched or stressed by loose objects, doors, lids, covers, sliding drawers, or roll-out racks,
  - b. walked on or rolled over by heavy traffic,
  - c. used for hand- or foot-holds (a protective guard should be placed over the cables where the possibility of such use exists), or
  - d. bent or sharply twisted.
- **6.9.1.3.2 Combining lines.** The layout and routing of lines shall be determined during design and made as simple and functionally logical as possible by combining lines into cables (preferable) or combining lines into harnesses if cables are not used.
- **6.9.1.3.3 Segregate conductors.** Conductors shall be segregated into cables or harnesses according to their functions and relationships to replaceable equipment.
- **6.9.1.3.4 Routing over pipes.** Electrical wires and cables shall be mounted above, rather than under, pipes or fluid containers.

- **6.9.1.3.5 Lightly insulated wires.** Lines and cables that are lightly insulated shall be at least 19 mm (0.75 in) from a potential ground.
- **6.9.1.3.6 Protection.** Raceways, stuffing tubes, conduit, junction boxes, and insulation shall be provided as necessary to obtain the required degree of protection, security of mounting, and ease of maintenance.
- **6.9.1.3.7 Visual and physical access.** Lines, cables, and wire harnesses shall be routed so that they are readily accessible for inspection and repair, especially at points of connection, splicing, and testing.
- **6.9.1.3.8 Unobstructed access.** Lines and cables shall be accessible without requiring disassembly or removal of other equipment or components.
- **6.9.1.3.9 Replacement.** Lines and cables shall be accessible throughout their route for removal and replacement if they are damaged.
- **6.9.1.3.10 Areas to avoid.** High voltage lines and cables shall be routed away from sensitive equipment, high temperature sources, work areas, controls, and the like.
- **6.9.1.3.11 Ease of maintenance.** Line and cable routing shall facilitate maintenance by ensuring that each unit of equipment can be moved to a convenient place for maintenance activities; extension cables shall be provided if necessary.
- **6.9.1.3.12 Nonobstruction.** Line and cable routing shall not obstruct visual or physical access to equipment for operation or maintenance.
- **6.9.1.3.13 Remote switches.** Lines and cables shall not be routed through remote switches which may be turned on and off inadvertently while maintenance is being performed.
- **6.9.1.3.14 Cables within racks.** Cables shall not be terminated or mounted on the front of cabinets, control panels, display panels, or on the face of equipment racks. Test cables are an exception to this criterion (see paragraph 6.9.1.6.4).
- **6.9.1.3.15 Shortest route.** Lines and cables shall be routed over the shortest runs allowable by lead, mounting, and other requirements.

#### 6.9.1.4 Leads

- **6.9.1.4.1 No weight-bearing.** Leads shall be mounted so that they do not bear the weight of cables, harnesses, or other components.
- **6.9.1.4.2 Support.** Leads shall be mounted so that they are supported at splices and points of connection.

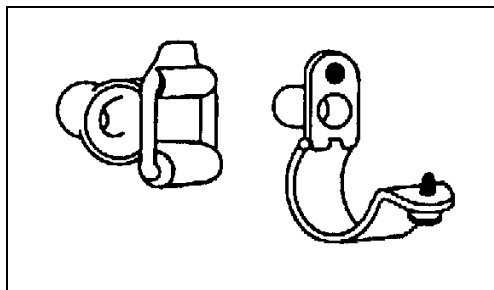
- **6.9.1.4.3 Orientation.** Where possible, leads shall be mounted so that they are oriented in a way that prevents erroneous connection or "crossing".
- **6.9.1.4.4 No flexing.** Leads shall be mounted so that they do not allow flexing at weak areas, for example, at splices, solder points, points where the conductor is bare or crimped, or points where strands are tinned together.
- **6.9.1.4.5 Signal checks.** Signal flow checks shall be made possible by the appropriate arrangement, location, and mounting of leads.

### 6.9.1.5 Clamps and mounting plates

- **6.9.1.5.1 Snug fit.** Clamps and mounting plates shall fit snugly without deforming or crimping the line or cable.
- **6.9.1.5.2 Spacing.** Clamps and mounting plates shall be operable by hand or with common hand tools.

- **6.9.1.5.3 Special clamps.** Quick-release clamps (hinged or spring) shall be used if cables are removed frequently. Hinged clamps are preferable for non-overhead mounting, because they support the weight of the line during maintenance, freeing the maintainer's hands for other tasks. Exhibit 6.9.1.5.3 shows these two types of clamps.

**Exhibit 6.9.1.5.3** Quick-release clamps, hinged and spring



**Discussion.** For overhead mounting, a spring clamp with a hinged, locking latch over the clamp's open side is preferable because it would help prevent accidents.

- **6.9.1.5.4 Placement.** Clamps and mounting plates shall be located at both ends of bends where the bending radius is 75 mm (3 in) or less.
- **6.9.1.5.5 Unsupported cable.** Lengths of cable or wire longer than 300 mm (12 in) shall be attached to the equipment chassis by means of clamps, unless contained in wiring ducts or cable retractors.
- **6.9.1.5.6 Visibility of clamps.** All clamps shall be visible when equipment is installed.



- **6.9.1.5.7 Mechanically-mounted clamps.** If a wire or cable is not routed through a wiring duct or conduit, it shall be attached with mechanically-mounted (not adhesive) cable clamps.

**Discussion.** Mechanically-mounted clamps can ensure the correct routing of electrical cables within and between units of equipment. They can also: (1) ensure that cables do not hinder or obstruct equipment maintenance, (2) prevent chafing due to contact with an adjacent surface, and (3) facilitate the mating of cables with their associated equipment.

- **6.9.1.5.8 Nonconductive.** Clamps and mounting plates that secure a conductor shall be nonconductive or properly insulated.

### 6.9.1.6 Test and extension cables

Test and extension cables need to be planned, designed, and provided to increase the efficiency and ease of maintenance.

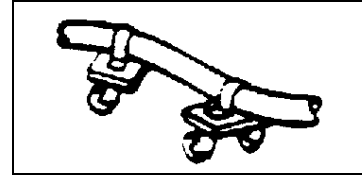
- **6.9.1.6.1 Easy access.** Test and extension cables shall allow equipment and components to be moved to a convenient location for the performance of maintenance activities.
- **6.9.1.6.2 Multiple related functions.** Test and extension cables should serve as many related functions as possible, but should avoid the possibility of misuse or misconnection.
- **6.9.1.6.3 Support equipment.** Test and extension cables shall permit support equipment to be placed in a convenient location.
- **6.9.1.6.4 Noninterference.** If it is essential that test cables terminate on control and display panels, the panel test receptacles shall be located so that the test cables will not visually or physically interfere with operational controls and displays.
- **6.9.1.6.5 Storage provisions.** Adequate storage shall be provided for test and extension cables. For example, racks, hooks, or cable winders might be provided within the storage place.
- **6.9.1.6.6 Handling devices for cable.** Reels or reel carts shall be provided for handling large, heavy, or long lines of cable. Exhibit 6.9.1.6.6 shows an example of a line and cable reel cart.
- **6.9.1.6.7 Automatic rewind.** If reels or reel carts are provided, they should rewind the cable automatically, when possible.

**Exhibit 6.9.1.6.6**  
Line and cable reel carts



- **6.9.1.6.8 Mobile support.** If especially large lines or cables must be moved frequently, wheels or other mobile supports shall be provided. Exhibit 6.9.1.6.7 shows an example of a line and cable mobile support.

**Exhibit 6.9.1.6.8** Line and cable mobile support



### 6.9.1.7 Bench mockup cables

- **6.9.1.7.1 Extension cables.** Bench mockups shall have extension cables for all units so that the units can be removed from the bench mockup for the performance of maintenance activities (same as paragraph 6.15.6.3).
- **6.9.1.7.2 Connectors on mockup cables.** Bench mockup cables shall have connectors that require only a strong push or pull to connect or disconnect them. Bench mockup cables are not subject to strong vibration or shock, but they are connected and disconnected frequently (same as paragraph 6.15.6.4).
- **6.9.1.7.3 Coverings.** Mockup cables shall have an extra-heavy covering (for example, vinyl tubing) to protect them from wear resulting from frequent connection and disconnection (same as paragraph 6.15.6.5).
- **6.9.1.7.4 Checking signal flow.** Bench mockup cables, including extension cables for units of equipment, shall have test points to check the signal flow through each wire (same as paragraph 6.15.6.6).

**Examples.** One method for accomplishing this is to provide test points at the connector; another is to provide test points on the junction boxes or terminal strips.

### 6.9.1.8 Labeling, marking, and coding

- **6.9.1.8.1 Coding wire.** Insulated wire, cables, and electrical connectors shall be color- or number-coded in accordance with standards (for example, MIL-STD-195 and MIL-STD-681) acceptable to the acquisition agency.

**Discussion.** Number-coded wire, cables, and electrical connectors are preferred so that maintainers who have problems discriminating various colors may be able to identify these items.

- **6.9.1.8.2 Identification.** Cables shall be labeled to indicate the equipment with which they are associated and the connectors with which they mate.

- 6.9.1.8.3 Identification of terminals on terminal strips or blocks.** Terminals on terminal strips or blocks shall be identified on the terminal strip or block itself or on the chassis, adjacent to the terminals (same as paragraphs 6.8.8.4 and 6.10.5.8).

- 6.9.1.8.4 Methods of color-coding.** Conductors shall be color-coded using, in order of preference, (1) solid-color insulation, (2) solid-color insulation with a colored-stripe tracer, or (3) color braid insulation with a woven tracer.

**Exhibit 6.9.1.8.4** Electrical cable coding

Number of Conductor	Basic color	Tracer
1	Black	None
2	White	None
3	Red	None
4	Green	None
5	Orange	None
6	Blue	None
7	White	Black
8	Red	Black
9	Green	Black
10	Orange	Black
11	Blue	Black
12	Black	White

**Explanation.** Exhibit 6.9.1.8.4 shows 21 discriminably different pattern variations based on different insulation and tracer colors. For more than 21 wires, see MIL-STD-686. If a wire's color coding is susceptible to becoming obscured, wires may be coded with numbered metal tags.

- 6.9.1.8.5 Cables within a sheath.** Cables containing individually insulated conductors with a common sheath shall be coded. The coding shall be repeated every 300 mm (12 in) along their entire length.
- 6.9.1.8.6 Coding for orientation.** Coding by such means as color or labels shall identify the correct item and its proper orientation or replacement.
- 6.9.1.8.7 Color-coded values for fixed resistors and small capacitors.** Fixed resistors and small capacitors shall be color-coded in accordance with exhibit 6.9.1.8.7. For fixed resistors (starting at the left-hand side), the first and second bands are for significant values, the third band is for the multiplier, and the fourth band signifies the tolerance value. The extra color band on the capacitor indicates the temperature coefficient.

**Example.** If a resistor is coded blue, gray, blue, and black (from left to right), its resistance is equal to  $68M\Omega \pm 20\%$ .

**Exhibit 6.9.1.8.7** Values for color-coded fixed resistors and small capacitors

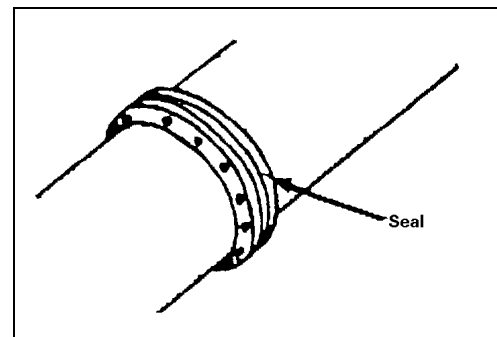
Significant figures	Color	Multiplier	Color	Tolerance
0	Black	1	Black or no color	± 20%
1	Brown	10		
2	Red	100	Silver	± 10%
3	Orange	1,000	Gold	± 5%
4	Yellow	10,000		
5	Green	100,000		
6	Blue	1,000,000		
7	Violet	--		
8	Gray	--		
9	White	--		
--	Gold	0.1		
--	Silver	0.01		

## 6.9.2 Fluid and gas lines

### 6.9.2.1 General

- **6.9.2.1.1 Use of flexible tubing.** Flexible tubing should be used instead of rigid lines, because it allows more flexibility in handling, can be backed-off easily, and is easier to thread through equipment when replacement is required.
- **6.9.2.1.2 Use of flexible hose.** Flexible hose should be used rather than pipes or tubing where minimum space is available for removing, handling, or replacing lines.

- **6.9.2.1.3 Visibility.** Gaskets and seals used in fluid and gas line connectors shall be visible after they are installed so that maintainers can see that the gasket or seal is present as illustrated in exhibit 6.9.2.1.3 (same as paragraph 6.8.7.7).

**Exhibit 6.9.2.1.3** Externally visible seals

- **6.9.2.1.4 Nonprotrusion.** Gaskets and seals used in fluid and gas connectors shall not protrude beyond the coupling (same as paragraph 6.8.7.8).

**Discussion.** Protruding gaskets and seals might be susceptible to damage, and that damage might spread internally, destroying the seal. Tapered nylon or Teflon washers of appropriate size can be employed to prevent extrusion.

- **6.9.2.1.5 Quick-action connectors.** Quick-action connectors shall be used on lines that require frequent disconnection.
- **6.9.2.1.6 Preventing leakage.** When quick-action connectors are used, self-sealing features should be provided to prevent leakage of fluid when the line is disconnected.
- **6.9.2.1.7 Standardized fittings.** To avoid the possibility of mismatching connectors during service or maintenance, fittings shall be standardized so that lines that differ in the substances they carry cannot be interchanged.
- **6.9.2.1.8 Avoiding spraying fluids.** Lines shall be kept from spraying or draining fluid on personnel or equipment during disconnection by locating connections away from work areas and sensitive components, shielding sensitive components where required, and providing drains and bleed fittings so lines can be drained or depressurized before they are disconnected (same as paragraph 12.6.4).
- **6.9.2.1.9 High-pressure lines.** Systems that contain liquids or high pressure gases (pressures exceeding 125 psi) shall be provided with isolation or disconnect valves to permit isolation for servicing and to aid in leak detection.
- **6.9.2.1.10 Cutoff valves.** Cutoff valves shall be provided at appropriate locations in the system to permit isolation or drainage of the system for maintenance and during emergencies.
- **6.9.2.1.11 Avoiding drainage problems.** Drainage problems shall be avoided by:
  - a. designing lines so they can be emptied completely if necessary,
  - b. making bends horizontal, rather than vertical, to avoid fluid traps,
  - c. avoiding low points or dips in lines that make them difficult to drain, and
  - d. providing special drains where low points do occur.

### **6.9.2.2 Routing and mounting**

- **6.9.2.2.1 Accessibility.** Fluid and gas lines mounted in cable trays shall be located for ready access.

- **6.9.2.2.2 Disconnecting.** Fluid lines should be mounted and installed so that rigid lines with connectors do not have to be backed-off before they can be disconnected (see paragraph 6.8.6.1).
- **6.9.2.2.3 Areas to avoid.** High pressure lines and cables shall be routed away from sensitive equipment, high temperature sources, work areas, controls, and the like.
- **6.9.2.2.4 Fuel lines.** Fuel lines shall be routed below electrical cables and hot pipes.
- **6.9.2.2.5 Heat resistant liners.** If fluid and gas lines are likely to become extremely hot, clamps and mounting plates shall be lined with heat resistant material so the maintainer will not be burned.
- **6.9.2.2.6 Avoiding line kinking.** Fluid and gas lines should be installed and mounted with sufficient clearance from surrounding equipment and structures to allow the maintainer to disconnect and remove the lines without bending or kinking them.

### 6.9.2.3 Clamps and supports

- **6.9.2.3.1 External service supports.** Unmounted lines attached to equipment (for example, lines from external service or test equipment or lines attached for other purposes) shall have supports capable of withstanding:
  - a. the initial surges of pressure through the line,
  - b. the weight of external extensions, and
  - c. the wear and tear of handling and repeated connection and disconnection.
- **6.9.2.3.2 Spring clamps.** Spring clamps shall be used to mount tubing and fluid pipes that may require frequent removal and replacement.

**Discussion.** For overhead mounting, a spring clamp shall be used with a hinged-locking latch over the clamp's open side to prevent accidents (see paragraph 6.9.1.5.3).

### 6.9.2.4 Labeling, marking, and coding

- **6.9.2.4.1 Fluid conductor coding.** Fluid conductors shall be either color coded (see exhibit 6.9.2.4.1), or coded by metal tags. Metal tags shall be used where adverse conditions (such as grease or mud) could obscure colors; otherwise, color coding shall be used.

**Exhibit 6.9.2.4.1** Color coding of fluid conductors

Contents	Valve handwheels and operating levers	Fed. Std 595 color number and chip
Steam	White	17886
Potable water	Dark blue	15044
Nitrogen	Light gray	16376
High pressure air	Dark gray	16081
Low pressure air	Tan	10324
Oxygen	Light green	14449
Salt water	Dark green	14062
Fuel oil	Yellow	13538
Lube oil	Yellow	13538
Fire protection	Red	11105
Foam discharge	Striped red/ green	11105 14062
Gasoline	Yellow	13538
Feedwater	Light blue	15200
Hydraulic	Orange	12246
Freon	Dark purple	17100
Hydrogen	Chartreuse	23814
Sewage	Gold	17043

- 6.9.2.4.2 Valve color coding.** Valves shall be color coded in accordance with the substances they control or the function they perform. Exhibit 6.9.2.4.2 lists recommended color codes for valves by substance.

**Exhibit 6.9.2.4.2** Valve color coding scheme

Contents	Color
Fuel	Red
Water injection	Red -gray-red
Lubrication	Yellow
Hydraulic	Blue & yellow
Pneumatic	Orange & blue
Instrument air	Orange & gray
Coolant	Blue
Breathing oxygen	Green
Air conditioning	Brown & gray
Fire protection	Brown
De-icing	Gray
Compressed gases	Orange
Electrical conduit	Brown & Orange

- 6.9.2.4.3 Hydraulic and pneumatic line coding.** Hydraulic and pneumatic lines shall be coded based on arrangement, size, shape, and color as necessary. Exhibit 6.9.2.4.3 lists color codes for lines by function.

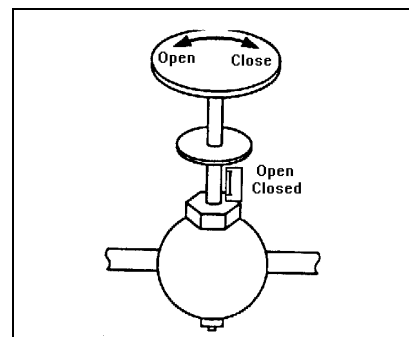
**Exhibit 6.9.2.4.3** Hydraulic and pneumatic line color coding scheme

Function	Color	Definition of function
Intensified pressure	Black	Pressure in excess of supply pressure induced by booster or intensifier.
Supply pressure	Red	Pressure of the power-actuating fluid.
Charging pressure	Intermittent red	Pump-inlet pressure, higher than atmospheric pressure.
Reduced pressure	Intermittent red	Auxiliary pressure lower than supply pressure.
Metered flow	Yellow	Fluid at a controlled flow rate (other than pump delivery).
Exhaust	Blue	Return of the power-actuating fluid to reservoir.
Intake	Green	Subatmospheric pressure, usually on the intake side of the pump.
Drain	Green	Return of leakage of control-actuating fluid to reservoir.
Inactive	Blank	Fluid within the circuit but not serving a functional purpose during the phase being represented.

- 6.9.2.4.4 Label contents.** Codes and labels shall be provided on, or adjacent to, the line as necessary to indicate the direction of flow.
- 6.9.2.4.5 Valve position labeling.** Labels or other marking devices shall be provided to clearly designate the position of a valve control. Exhibit 6.9.2.4.5 illustrates labeling of a valve control.

**Example.** A rider, as illustrated in exhibit 6.9.2.4.5, may be attached to the shaft to indicate the fully opened and fully closed positions.

**Exhibit 6.9.2.4.5** Valve position labeling





## 6.10 Packaging, layout, and mounting of internal components

Criteria and guidelines for the packaging, layout, mounting, labeling, and marking of internal modules, components, and parts are given in this section. All of these can affect the ease or difficulty of maintenance activities.

**Definitions.** A **module** is an assemblage of two or more interconnected parts or components that comprise a single physical and functional entity (for example, a printed circuit board). It is this singular functionality that defines a module. A **component** is a subdivision of a unit of equipment that can be treated as an object by the maintainer, but which can be further broken down into parts. A mounting board together with its mounted parts is an example of a component. A **part** is an object that cannot normally be broken down further without destroying its designated use. Fuses, resistors, and capacitors are examples of parts. **Packaging** is the grouping of functions, components, and parts into units or modules; **layout** is the physical arrangement of the parts and components that make up a module or a unit of equipment; **mounting** is the positioning and attachment of parts, components, and modules.

### 6.10.1 General

- **6.10.1.1 Accessibility.** Parts and modules on which maintenance is performed shall be positioned so that the maintainer has complete visual and physical access.
- **6.10.1.2 Minimize tool requirements.** Parts and modules shall be packaged, laid out, and mounted so that maintenance activities require a minimum number and variety of tools, preferably only common hand tools.
- **6.10.1.3 Minimize maintainer movement.** Parts and modules should be packaged, laid out, and mounted so that a minimum of movement is required of the maintainer in carrying out maintenance activities.
- **6.10.1.4 Organized by maintenance specialty.** Parts and modules should be packaged, laid out, and mounted so that maintenance activities by one maintenance specialist do not require removal or handling of equipment or components maintained by another specialist.

### 6.10.2 Packaging

Dividing a unit of equipment into a number of separate modules has several advantages: it can permit specialization by maintainers; it can speed up corrective maintenance; and it can make working on malfunctioning units easier.

**Definition.** **Modularization** is the separation of equipment into physically and functionally distinct units that can be easily removed and replaced.

### 6.10.2.1 Modularization

- **6.10.2.1.1 Modularization.** Units of equipment should be divided into as many modules as are electrically and mechanically practical and feasible for maintenance (see also paragraph 6.1.2.7).
- **6.10.2.1.2 Single function.** A module shall contain only parts that contribute to a single function; it shall not provide multiple, divergent functions.
- **6.10.2.1.3 Physical and functional interchangeability.** If modules are physically interchangeable, they shall also be functionally interchangeable; if they are not functionally interchangeable, they shall not be physically interchangeable.
- **6.10.2.1.4 Distinguishability of noninterchangeable modules.** Noninterchangeable modules shall be distinguishably different in appearance, and this difference shall be apparent when the module is in its installed position.
- **6.10.2.1.5 Unreliable components.** If a module contains some parts that are significantly less reliable than the remaining parts, the unreliable parts should be accessible without removal of the module.
- **6.10.2.1.6 Maintenance in installed location.** Modules shall be designed so that required maintenance can be performed with the module in its installed position, without requiring disconnection, disassembly, or removal of other modules.
- **6.10.2.1.7 Testing.** Modules shall be designed to permit testing when they are removed from their installed position, and they shall require little or no calibration immediately after installation.

### 6.10.2.2 Modularization methods

The breaking up of a unit of equipment into modules is done in accordance with one or more of the following methods: (1) logical flow packaging, (2) circuit packaging, or (3) component packaging.

In logical flow packaging, circuits, parts, and components are packaged and arranged in correspondence with their functional relationships.

In circuit packaging, all parts of a single circuit or logically related group of parts, and only that circuit or group, are placed in a separate module.

In component packaging, similar parts or components are located together, for example, all the fuses or all the relays might be grouped together.

- **6.10.2.2.1 Modularization method.** The modularization of equipment should be done using one or more of the following

methods, in this order of preference: (1) logical flow packaging, (2) circuit packaging, (3) component packaging.

- **6.10.2.2.2 Logical flow packaging.** If logical flow packaging is used:
  - a. Circuits and parts shall be packaged and located in an arrangement that parallels their functional relationships.
  - b. A module shall be designed so that only single input and output checks are necessary to isolate a fault in the module.
  - c. The unidirectional signal flow within a module shall be clearly indicated.
- **6.10.2.2.3 Circuit packaging.** If circuit packaging is used:
  - a. All parts of a given circuit or group of logically related parts shall be located in a single module.
  - b. A module shall contain only one circuit or group of related parts.
  - c. The circuit shall be packaged as a single terminal board or plug-in module when possible.
  - d. Circuits shall be grouped to minimize crisscrossing of signals among modules.
- **6.10.2.2.4 Component packaging.** If component packaging is used:
  - a. Similar components should be grouped in one location, for example, all fuses or all relays.
  - b. Inexpensive components should be placed on separate plug-in boards that can be discarded upon failure.
  - c. Similar parts that are likely to require replacement at approximately the same time should be grouped together.
  - d. Components requiring the same maintenance activity should be grouped together, for example test points or components requiring a particular cleaning method.
- **6.10.2.2.5 Printed circuit boards.** If printed circuit boards are used:
  - a. Printed circuit boards shall be designed and mounted for ease of removal and foolproof replacement.
  - b. Plug-in printed circuit boards shall be structurally rigid and easy to remove and replace, providing finger access and gripping aids if necessary.

- c. Feedback shall be provided to the maintainer when plug-in printed circuit boards are securely connected.
- d. Printed circuit boards shall be identified in accordance with MIL-STD-130, and references for parts mounted on the board shall be provided in accordance with MIL-STD-454, Requirement 67.

### 6.10.3 Layout

Criteria and guidelines governing the layout of the parts that make up a module fall into three general categories: (1) accessibility of the parts, (2) logical or functional grouping of parts, and (3) protection of maintainers and equipment from hazards.

#### 6.10.3.1 Accessibility

- **6.10.3.1.1 No interference from other parts.** Modules shall be laid out so that all parts can be removed and replaced without interference from and without removal of other parts.
- **6.10.3.1.2 No stacking of parts.** The parts that make up a module shall be mounted in an orderly, flat, two-dimensional array; they shall not be stacked one on top of another.
- **6.10.3.1.3 Consistent orientation.** If a module has more than one part of the same type that must be inserted in a particular orientation (connectors, for example), all those parts should be oriented in the same direction.
- **6.10.3.1.4 Spacing of parts.** The parts that make up a module shall be positioned so that any required tools (such as test probes or soldering irons) can be used without difficulty.
- **6.10.3.1.5 Separation of parts and wiring on printed circuit boards.** On printed circuit boards, all parts shall be mounted on one side of the board, and all wiring (including printed circuits) shall be placed on the other side.
- **6.10.3.1.6 Spacing of terminals.** Terminals to which wires are to be soldered shall be far enough apart that work on a terminal does not damage neighboring terminals or nearby parts (same as paragraph 6.8.5.2.9).
- **6.10.3.1.7 Frequently inspected component parts.** Parts that require frequent visual inspection (fuses, for example) shall be located where they can be seen easily without the removal of panels, covers, or other modules.
- **6.10.3.1.8 High failure-rate parts.** Parts that have a high failure rate, such as fuses, shall be located where they can be seen and replaced without the removal of other parts.
- **6.10.3.1.9 Indicator lights.** If a module contains indicator lights, it should be possible to change the lights from the front panel, that is, without opening or removing the module.

- **6.10.3.1.10 Shutoff switches.** If the module contains emergency shutoff switches, they shall be positioned within easy reach of the maintainer, and they shall be located or guarded to prevent inadvertent operation.
- **6.10.3.1.11 Visual and physical accessibility.** Test points, adjustment points, and cable and line connectors shall be located where the maintainer can see them easily and perform any required operations on them without interference.

### 6.10.3.2 Grouping of parts

- **6.10.3.2.1 Grouping maintenance displays.** All maintenance displays relevant to a particular task shall be grouped together and located where they are easily visible to the maintainer.
- **6.10.3.2.2 Separating maintenance and operational displays.** If a module contains both maintenance and operational displays, the maintenance displays should be separated from the operational displays.

### 6.10.3.3 Hazard protection

- **6.10.3.3.1 Avoidance of damage to parts and wiring.** The parts and wiring of a module shall be located and arranged so that they are not damaged when the module or the unit of equipment of which they are part is opened and closed.
- **6.10.3.3.2 Avoidance of damage from handling.** Parts that are susceptible to damage during maintenance activities shall be located or shielded so that they will not be damaged during these activities.
- **6.10.3.3.3 Avoidance of damage from the environment.** Parts shall be positioned so that they are not likely to be damaged by oil, other fluids, dirt, or static electricity.
- **6.10.3.3.4 Protecting maintainers from heat and electrical shock.** If a module contains parts that retain heat or electrical potential after power is turned off, those parts shall be located where maintainers will not touch them during maintenance activities, or they shall be shielded to protect the maintainers. In addition, heat-producing parts shall be shielded to protect maintainers from injury.
- **6.10.3.3.5 Bleeder networks.** Parts that retain electrical potential after power is turned off shall be equipped with bleeder networks (see paragraph 12.4.3.1).
- **6.10.3.3.6 Separating internal controls from hazardous voltages.** Internal controls such as switches and adjustment controls shall not be located where maintainers might come into contact with hazardous voltages while operating the controls.

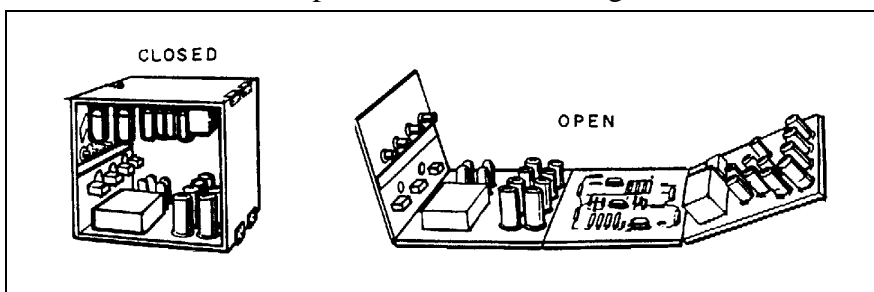
- **6.10.3.3.7 High current switching devices.** High current switching devices shall be shielded to prevent maintainers from coming into contact with them.

## 6.10.4 Mounting

This section describes several methods for mounting modules and gives criteria and guidelines pertaining to these methods; it then lists more general criteria and guidelines. The methods are: (1) foldout construction, (2) braces, (3) straps and brackets, and (4) shock mounts. In mounting a particular module, it may be appropriate to use more than one of these methods simultaneously.

- **6.10.4.1 Foldout mounting.** Foldout mounting should be used whenever feasible. Exhibit 6.10.4.1 gives an example of foldout mounting.

**Exhibit 6.10.4.1** Example of foldout mounting construction



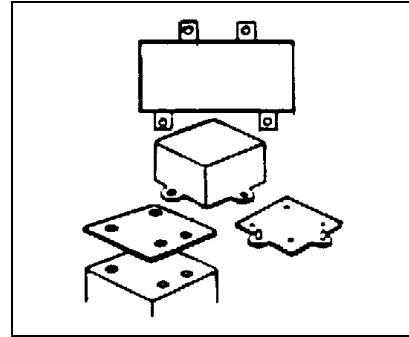
- **6.10.4.2 Prevention of damage with foldout mounting.** If foldout mounting is used, parts and wiring shall be positioned so that they are not damaged during opening and closing.
- **6.10.4.3 Support for hinged mounting.** If a module is mounted on hinges, some sort of brace or support shall be provided to hold the module in the "out" or "open" position.
- **6.10.4.4 Rests and stands.** If a module contains parts that might be damaged when it is moved into position for maintenance activities, the module shall include rests or stands that protect those parts. These rests and stands shall be integral parts of the construction of the module.
- **6.10.4.5 Straps and brackets -- characteristics.** Straps and brackets should:
  - a. be thick and rounded enough so that there are no sharp edges, and
  - b. be shorter than the part or module they hold so that they provide a clamping action.
- **6.10.4.6 Shock mounts.** Shock mounts should be used as appropriate to:

- c. eliminate vibration that would make displays and markings difficult to read,
- d. reduce noise levels that might be hazardous to maintainers, and
- e. reduce levels of vibration that might be hazardous to maintainers or equipment.

- **6.10.4.7 Preventing mounting errors by physical design.** Modules shall be designed so that it is physically impossible to mount them incorrectly.

**Discussion.** Incorrect mounting includes reversal, mismatching, and misaligning. Measures to prevent incorrect mounting include (1) the incorporation of keys or other aligning devices, (2) the provision of asymmetrical mounting brackets, and (3) the provision of asymmetrical mounting holes. Exhibit 6.10.4.7 illustrates all three of these measures.

**Exhibit 6.10.4.7** Error-free mounting provisions



- **6.10.4.8 Mounting and orientation of similar items.** Parts and modules that are similar shall use the same mounting method and be mounted with the same orientation.
- **6.10.4.9 Accessibility.** Parts and modules that are intended to be removed and replaced by maintainers shall be mounted so that they can be removed without the removal of other parts or modules and without interference from other parts or modules.
- **6.10.4.10 Controls.** Modules shall be mounted so that it is not necessary to disconnect controls that may be needed for maintenance.
- **6.10.4.11 Common hand tools.** Modules shall be designed so that they are replaceable by hand or with common hand tools.
- **6.10.4.12 Front access.** Modules designed to be replaceable should be accessible through the front surface of the equipment rather than the back.
- **6.10.4.13 Orientation of modules within cases.** If a module has a case, the proper orientation of the module within its case shall be obvious, preferably through the physical design of the case, rather than through labeling.
- **6.10.4.14 "Plug-in" connectors.** Electrical connections between modules shall be made using plug-in connectors unless special

requirements, such as holding power or sealing, dictate another type.

### 6.10.5 Labeling and marking

- **6.10.5.1 When to use labels and markings.** Labels or markings shall be used to:
  - a. outline and identify functional groups of parts,
  - b. identify each part by name or symbol,
  - c. indicate direction of current or signal flow to aid troubleshooting, and
  - d. if applicable, identify the value and tolerance level of parts.
- **6.10.5.2 Location of labels and markings -- consistency.** Labels and markings shall be placed consistently in relation to the parts to which they refer. This placement may be on or immediately adjacent to the part.
- **6.10.5.3 Location of labels and markings -- eye level.** If the part being labeled or marked will be below eye level in its installed position, the label or mark should be above the item; if the item will be above eye level, the label or mark should be below the item.
- **6.10.5.4 Visibility.** Labels and markings shall be placed so that the maintainer can see them without having to move or remove anything.
- **6.10.5.5 Orientation.** Labels shall be horizontally oriented so that the maintainer can read them while the module is in its installed position.
- **6.10.5.6 Electrical parts.** Small electrical parts that are attached to mounting boards (resistors and capacitors, for example) shall be labeled or marked on the mounting boards.
- **6.10.5.7 Parts requiring identification.** The following parts shall be identified with labels or markings on the parts themselves or on the chassis or board adjacent to the part:
  - a. all parts identified by designations in drawings, schematics, and parts descriptions of the module,
  - b. all wires, sockets, plugs, receptacles, and similar parts having designations in wiring diagrams of the module,
  - c. all replaceable mechanical parts,



- d. all semi-fixed electrical items, such as fuses and ferrule-clipped resistors, and
  - e. items having critical polarity or impedance ratings.
- **6.10.5.8 Identification of terminals on terminal strips or blocks.** Terminals on terminal strips or blocks shall be identified on the terminal strip or block itself or on the chassis, adjacent to the terminals (same as paragraphs 6.8.8.4 and 6.9.1.8.3).
  - **6.10.5.9 Identification of terminals on parts.** Each terminal of a part having terminals (transformers, relays, and capacitors, for example) shall be identified adjacent to the terminal.
  - **6.10.5.10 Identification of parts accessible from both sides.** Receptacles for plugs and other parts that are accessible from both sides of a board or panel shall be identified on both sides.
  - **6.10.5.11 Adequacy of markings.** Markings shall be sufficient to identify a part or component.
  - **6.10.5.12 Durability of markings.** Markings shall be durable enough to last the life of the equipment.
  - **6.10.5.13 Marking stacked parts.** If parts or modules are stacked, marking shall permit identification of the individual parts or modules (see paragraph 6.10.3.1.2).
  - **6.10.5.14 Marking enclosed parts.** If a part or module is enclosed or shielded, the marking shall be placed outside the enclosure or shield.
  - **6.10.5.15 Designation of parts.** The alphanumeric designation of a part shall be in accordance with MIL-STD-16 or comparable industry standards.
  - **6.10.5.16 Hazard warnings.** If any hazard exists in connection with a part or module, a warning or caution label shall be provided on the part or module, on the case or cover, or both (see paragraph 12.16.1).
  - **6.10.5.17 Labeling symmetric parts.** Parts that are symmetric in shape shall be labeled or marked to indicate the proper orientation for mounting.
  - **6.10.5.18 Insertion holes.** If a module has holes through which parts that require proper alignment are inserted (tubes or connectors, for example), labels showing the proper orientation of the part to be inserted shall be placed adjacent to the holes (same as paragraphs 6.2.8.6 and 6.4.6.4).
  - **6.10.5.19 Auxiliary information for parts.** Parts to which auxiliary information applies (for example, values and tolerances of resistors and capacitors) shall be labeled with that information. Preferably this information will be in alphanumeric, not coded, form.

## 6.11 Adjustment controls

Criteria and guidelines for accessing, adjusting, sequencing, and reading adjustment controls are given in this section.

- **6.11.1 Controls and feedback.** Each adjustment control shall provide feedback. This feedback might be visual, audible, or tactile.
- **6.11.2 Simultaneous access to controls and displays.** Maintainers shall have simultaneous access to an adjustment control and its associated display or other source of feedback; that is, they shall be able to observe the effects of adjustments as they are made.
- **6.11.3 Location of adjustment controls.** All the adjustment controls for a module or unit of equipment should be located on a single surface, preferably the front panel or face of the equipment.
- **6.11.4 Differentiating maintenance controls from operational controls.** When maintenance and operation of a unit of equipment are performed by different sets of people, the maintenance and operational controls should not appear on the same panel. If maintenance and operational controls do appear on the same panel, the maintenance controls should be grouped and separated from the operational controls. If appropriate, the maintenance controls might also be guarded with removable covers so as not to interfere with the operator's performance (see paragraph 9.1.5).
- **6.11.5 Independence of adjustment controls.** Where possible and practical, the adjustment of one control shall be independent of the adjustments of other controls.
- **6.11.6 Sequential adjustments.** If the adjustment of one control affects the adjustment of another, the controls shall be arranged in sequential order, and labeled or marked to indicate the order of adjustment.
- **6.11.7 Functionally related adjustments.** If a maintenance task consists of adjusting several functionally related variables, a single control with a switch for selecting the particular function should be provided so that the maintainer can select the functions in sequence and make adjustments with the same control.
- **6.11.8 Direct readings.** If a maintenance task requires adjusting a control to achieve a certain value or range of values, the display shall permit direct reading of the value or range; the maintainer shall not have to convert or transform the reading.
- **6.11.9 Knob adjustments preferred to screwdriver adjustments.** Knob adjustments should be used rather than screwdriver adjustments, especially if the adjustment is made more than once a month.

- **6.11.10 Screwdriver adjustments -- preventing slipping.** When screwdriver adjustment controls are used, a positive means, such as guides or slots, shall be provided to prevent the screwdriver tip from slipping.
- **6.11.11 Screwdriver guides.** If a screwdriver adjustment must be made without the maintainer being able to see the control, or if the control is located near a high voltage, screwdriver guides shall be provided (see paragraph 6.7.3.2.4).
- **6.11.12 Use of mirrors or flashlights.** Maintainers shall not have to use mirrors or flashlights in making adjustments.
- **6.11.13 Remote adjustments.** If it is not practical to provide access to an internally located control, a remote control should be provided.
- **6.11.14 Degree of adjustment.** Controls shall accommodate the degree of adjustment required, that is, gross adjustment, fine adjustment, or both.
- **6.11.15 Mechanical stops.** Adjustment controls intended to have a limited range of motion shall have mechanical stops; these stops shall be capable of withstanding a force or torque 100 times greater than the resistance to movement within the range of adjustment.
- **6.11.16 Previous settings.** If a maintenance task requires that a maintainer be able to quickly return a control to its previous setting, the control shall have a scale and pointer or equivalent.
- **6.11.17 Preventing inadvertent adjustment.** Adjustment controls shall be located and mounted so that they cannot be adjusted inadvertently by the maintainer.
- **6.11.18 Critical or sensitive adjustments.** Critical or sensitive adjustments shall incorporate features, such as locking devices, to prevent inadvertent or accidental adjustment. If a locking device is used, operation of the locking device shall not change the adjustment setting.
- **6.11.19 Hand or arm support.** If an adjustment control or the maintainer will be subjected to disturbing vibration during adjustment, a suitable hand or arm support shall be provided.
- **6.11.20 Avoidance of hazards.** Adjustment controls shall not be located close to dangerous voltages, moving machinery, or other hazards. If a hazardous location cannot be avoided, the controls shall be appropriately labeled, shielded, and guarded.

## 6.12 Failure detection and isolation

This section contains criteria and guidelines for failure detection and isolation through the use of alarms, failure indications, and diagnostic aids.

### 6.12.1 Alarms

- **6.12.1.1 When to use.** If critical equipment is not regularly monitored, an alarm (auditory, visual, or both) shall be provided to indicate malfunctions or conditions that would cause personnel injury or equipment damage. Fire protection and associated alarm systems shall meet the requirements of Subpart L - Fire Protection of 29 CFR 1910. Employee alarm systems are governed by 29 CFR 1910.165.
- **6.12.1.2 Visual versus auditory alarm.** If an auditory alarm would be overly intrusive or disruptive, the alarm shall be visual.
- **6.12.1.3 Special alarm.** Auditory as well as visual alarms shall be provided to indicate malfunctions when maintenance must be performed in an area with a high degree of ambient illumination.
- **6.12.1.4 Loss of redundancy.** If part of a redundant system, unit of equipment, module, or component becomes inoperable, an alarm signalling the loss of redundancy shall be provided to the user immediately. Users shall be able to acknowledge such an alarm, but the lack of available redundancy shall be continuously displayed until the redundant system, equipment, module, or component becomes operable again.

### 6.12.2 Failure indicators

- **6.12.2.1 Overload indicators.** If appropriate, an overload indicator shall be provided for each major unit of equipment, component, or circuit, even if it may sometimes be desirable to keep the overloaded item in operation.
- **6.12.2.2 Out of range indicators.** If equipment has failed or is not operating within tolerance limits, an indication shall be provided.
- **6.12.2.3 Power failure indicators.** If a power failure occurs, an indication shall be provided.
- **6.12.2.4 Open circuit indicators.** If a fuse or circuit breaker has opened a circuit, an indication shall be provided.
- **6.12.2.5 Power-on indicator.** A power-on indicator that extinguishes with loss of power shall be provided.

### 6.12.3 Diagnostic aids

- **6.12.3.1 Automated aids.** Fault isolation, inspection, and checkout tasks shall be automated to the extent practical.
- **6.12.3.2 Automatic self-checking components.** All essential electronic computer and peripheral components that are part of a system shall incorporate an automatic self-check diagnostic test of

software and hardware, both at power up and at the request of the operator, to ensure they are functioning properly.

- **6.12.3.3 On-demand system check.** On-demand system checkout shall be available.
- **6.12.3.4 Fault detection.** Equipment design shall facilitate rapid and positive fault detection and isolation of defective items to permit their prompt removal and replacement.
- **6.12.3.5 Identification.** The area of equipment served by a fuse or circuit breaker shall be identified.
- **6.12.3.6 Sensor verification.** The status of sensors on replacement units shall be verifiable with respect to accuracy and proper operation.
- **6.12.3.7 Equipment verification.** When feasible, equipment shall permit verification of operational status prior to installation without the need for disassembly.
- **6.12.3.8 Fault detection without disassembly.** Equipment shall permit fault detection and isolation without removing components, through the use of built-in test, integrated diagnostics, or standard test equipment. Fault detection and isolation shall identify without ambiguity which component has failed.
- **6.12.3.9 Portable diagnostic tools.** When built-in test equipment is not available, diagnostic tools or portable equipment shall be provided to aid in fault isolation.

## 6.13 Fuses and circuit breakers

This section contains criteria and guidelines for systems that use fuses and circuit breakers. General criteria and guidelines address the selection and use of fuses and circuit breakers, the design characteristics of fuses, push-pull circuit breakers, toggle bat and legend switch circuit breakers, and the labeling of fuses and circuit breakers.

### 6.13.1 General

- **6.13.1.1 Selection of fuses and circuit breakers.** Fuses and circuit breakers should be selected so that they are appropriate to the particular function they will perform. Exhibit 6.13.1.1 lists the appropriate type of fuse or circuit breaker for a variety of functions.

**Discussion.** When selecting fuses or circuit breakers, consider the suitability of each to perform a particular function. There are two types of circuit breakers, thermal air and magnetic air. Thermal air circuit breakers are used primarily for overcurrent circuit protection. They are best adapted to DC circuits up to 250 volts, and to AC circuits up to 600 volts in capacities up to 600 amperes. Magnetic air circuit breakers may be used to provide

protection in event of overcurrent, undercurrent, reverse current, low voltage, and reverse phase.

**Exhibit 6.13.1.1** General comparison of fuses and circuit breakers

Function	Fuse	Thermal air	Magnetic air
Instantaneous action	X		X
Time delay features	X	X	X
Resetting		X	X
Adjustable tripping range for other than maximum			X
Automatic resetting			X
Remote control resetting and tripping			X
Overcurrent protection	X	X	X
Low current, reverse current, and low voltage protection			X

- **6.13.1.2 Location of fuses and circuit breakers.** Fuses and circuit breakers shall be grouped in a minimum number of centralized, readily accessible locations for removal, replacement, and resetting.
- **6.13.1.3 Verification of an open circuit.** An indication shall be provided when a fuse or circuit breaker has opened a circuit.
- **6.13.1.4 Individual fused units.** Fuses or circuit breakers should be provided so that each unit of a system is separately fused and adequately protected from harmful variations in voltages.

## 6.13.2 Fuses


- **6.13.2.1 Using fuses.** Fuses shall conform to MIL-F-15160.
- **6.13.2.2 Worker safety.** Fuse installations shall be designed so that only the "cold" terminal of the fuse can be touched by maintenance personnel.
- **6.13.2.3 Safeguarding the circuit.** Fuses shall be provided that safeguard the circuit if the wrong switch or jack position is used.
- **6.13.2.4 Quick-disconnect fuse holders.** Fuse holder cups or caps should be of the quick-disconnect type rather than the screw-in type; they should be knurled and large enough to be removed easily by hand.

- **6.13.2.5 No special tools for fuse replacement.** Fuse replacement shall not require special tools, unless they are needed for safety.
- **6.13.2.6 No other components to be removed.** Fuses shall be located so they can be replaced without removing any other components.
- **6.13.2.7 Spare fuse provisions.** Spare fuses and holders for them shall be provided and located near fuse holders. Labels adjacent to these spare fuse holders shall contain the word "SPARE" and shall state the fuse values and functions.
- **6.13.2.8 Anticorrosion precautions.** A silicon electrical lubricating compound should be applied to the fuse and the interior of the fuse holder. The exterior of the fuse holder (except contact surfaces) should be coated with fungicidal varnish. Sealed fuses should be used.

### 6.13.3 Push-pull circuit breakers


- **6.13.3.1 Push-pull circuit breaker specifications.** Push-pull actuated circuit breaker dimensions, displacement, and separation shall conform to exhibit 6.13.3.1.
- **6.13.3.2 Power switches.** Push-pull type circuit breakers shall not be used as power switches.

## Exhibit 6.13.3.1 Push-pull circuit breaker specifications



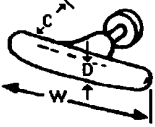
Push-pull control, low resistance, for two-position, mechanical and electrical systems. Alternate three position plus rotary function acceptable for application such as vehicle headlight plus parking lights, panel and dome lights. Provide serrated rim.

D. Minimum diameter 19 mm (0.75 in)	C. Minimum clearance 25 mm (1.0 in) add 13 mm (0.5 in) for gloved hand	12-38 mm (0.5-1.5 in) Minimum between pull positions: 13 mm (0.5 in)	S. Minimum space between: 38 mm (1.5 in) add 13 mm (0.5 in) for gloved hand
---	---	--	---



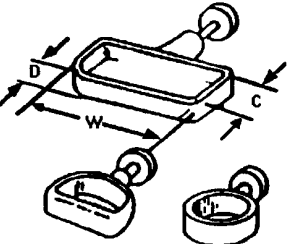
Alternate handle; miniature electrical panel switch only. Avoid glove use application.

D. Minimum diameter: 6.5 mm (0.25 in)	N/A	L. Minimum length 19 mm (0.75 in)	Minimum: 13 mm (0.5 in)	S. Minimum space between: 25 mm (1 in)
---	-----	---	-------------------------------	---



High-force push-pull, for two-position mechanical system only.

W. Minimum width: 100 mm (4 in)	D. Depth: 16-38 mm (0.6-1.5 in)	C. Minimum clearance: 38 mm (1.5 in) add 6 mm (0.24 in) for gloved hand	Minimum 25 mm (1 in) Preferred: 50 mm (2 in)
---------------------------------------	---------------------------------------	--	---



Same as above. Preferred where possible garment or cable-snag possibility exists.

W. Minimum width: 100 mm (4 in)	D. Depth: 16-38 mm (0.6-1.5 in)	C. Minimum clearance 38 mm (1.5 in)	Minimum: 25 mm (1 in) Preferred: 50 mm (2 in)	S. Minimum space between: 13 mm (0.5 in)
---------------------------------------	---------------------------------------	---	--	---

**Note.** 1 and 2 finger pulls also acceptable for less than 18 N (4.0 lb) application

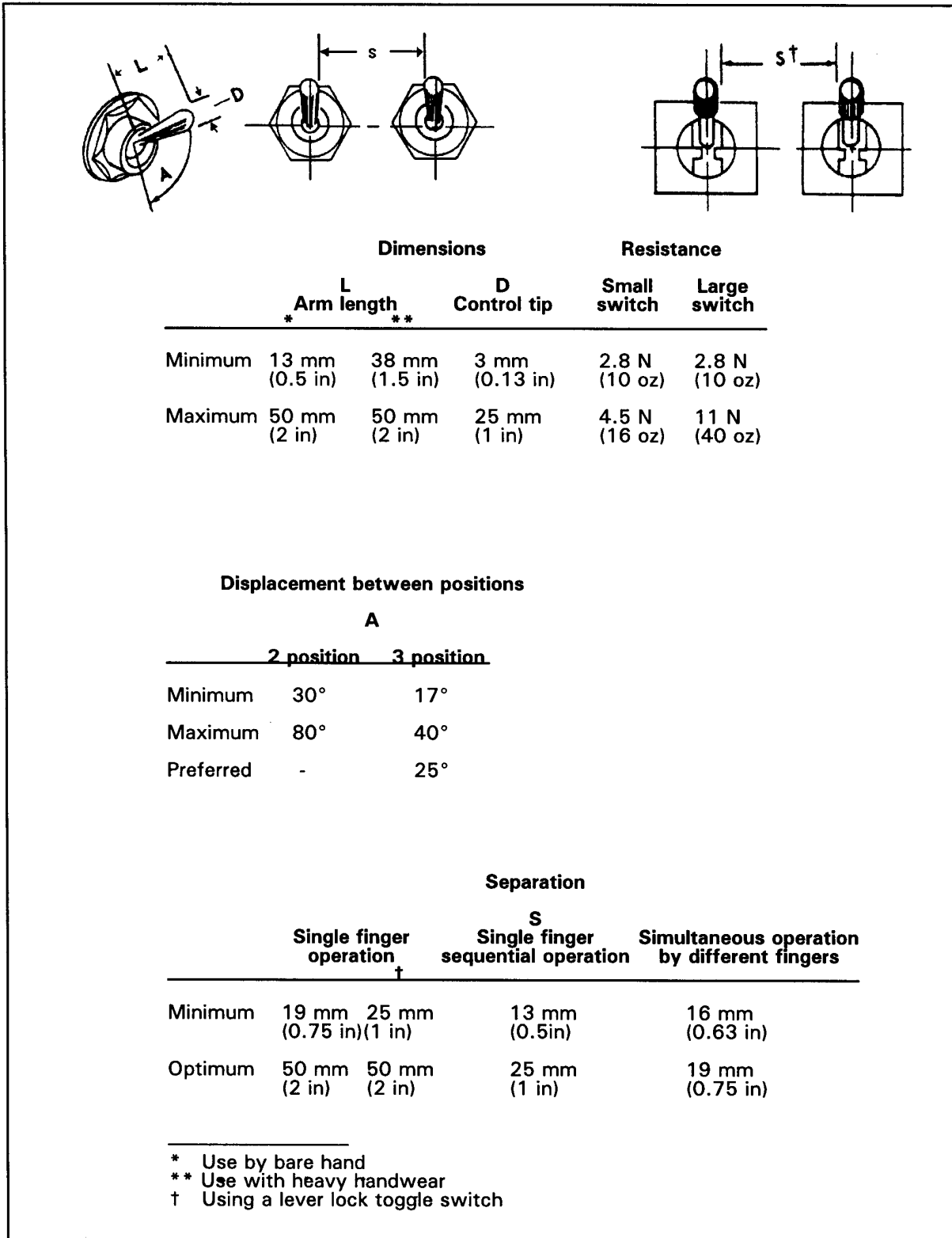
## 6.13.4 Toggle bat and legend switch circuit breakers

Toggle bat and legend switch actuated circuit breakers may be used to control electrical power.

- 6.13.4.1 **Toggle bat specifications.** Dimensions, resistance, displacement, and separation for toggle bat actuated breakers shall comply with exhibit 6.13.4.1.

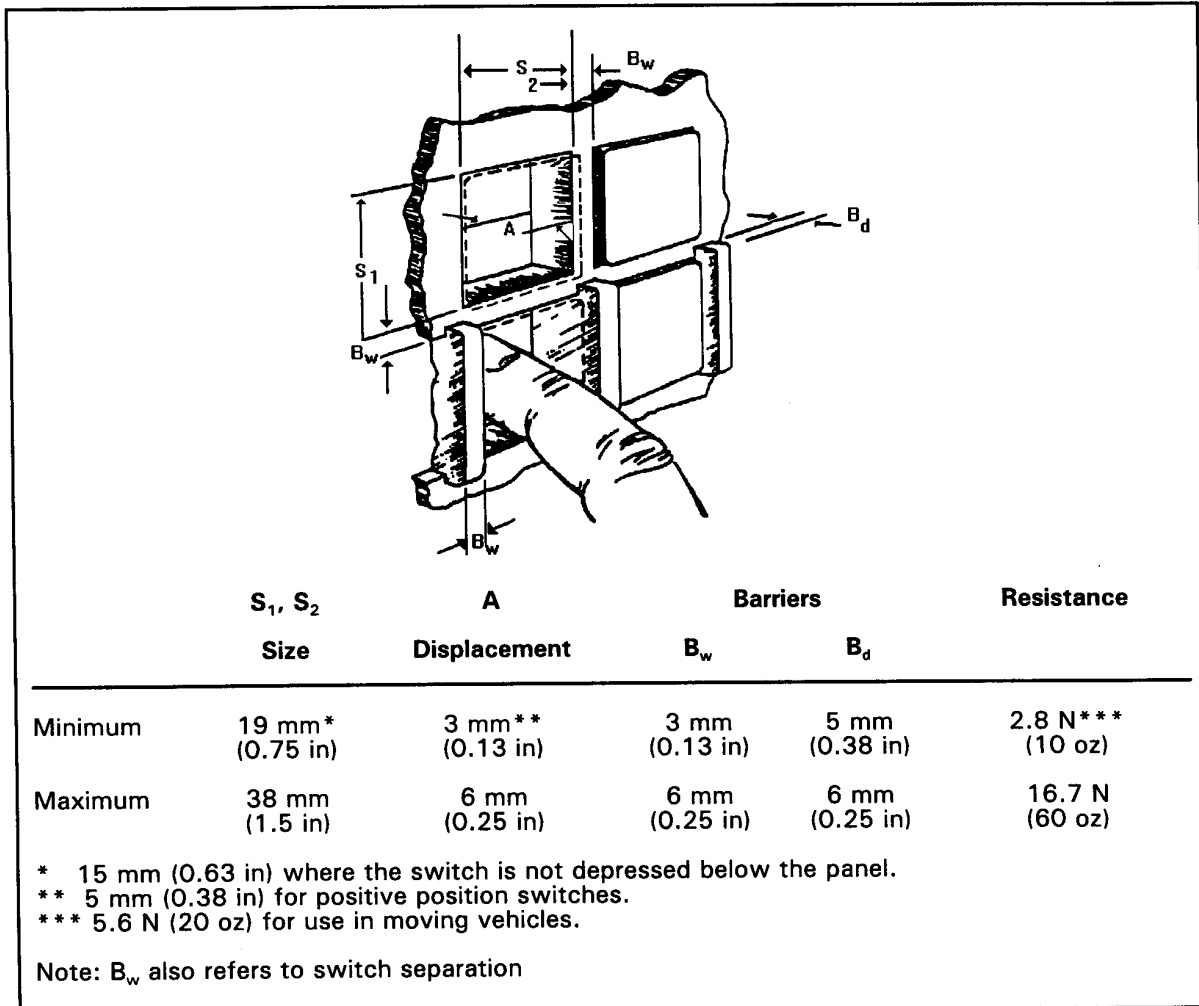


**Exhibit 6.13.4.1 Toggle bat specifications**



- 6.13.4.2 **Legend switch specifications.** Legend switch actuated breakers shall comply with the dimension, displacement, separation, and resistance criteria shown in exhibit 6.13.4.2.

Exhibit 6.13.4.2 Legend switch specifications



### 6.13.5 Labeling and marking

- 6.13.5.1 **Fuses and circuit breakers.** Fuses and circuit breakers shall be permanently labeled or marked. The labeling or marking shall be legible in the anticipated ambient illumination range for the maintainer's location.
- 6.13.5.2 **Fuse ratings.** A fuse's rating shall be indicated adjacent to the fuse. The rating shall be in whole numbers, common fractions, such as 1/2, or whole numbers and common fractions, such as 2 1/2.

## 6.14 Test points and service points

- **6.13.5.3 Circuits.** The area of equipment served by a fuse or circuit breaker shall be identified.

Strategically placed test points make signals available to maintenance personnel for checking, adjusting, and troubleshooting. Test points are recommended for units of equipment that are not completely self-checking.

**Definition. Test points** are a means for conveniently and safely determining the operational status of equipment and for isolating malfunctions. **Service points** are a means for lubricating, filling, draining, charging, and performing other service functions. They permit the routine performance of these services on all equipment and components requiring them.

### 6.14.1 Adjustment controls

- **6.14.1.1 Location.** An adjustment control associated with a test point shall be located near the test point and shall provide a signal at the test point that indicates clearly when the correct adjustment has been achieved.
- **6.14.1.2 Individual adjustment controls.** A test point should not have more than one associated adjustment control.

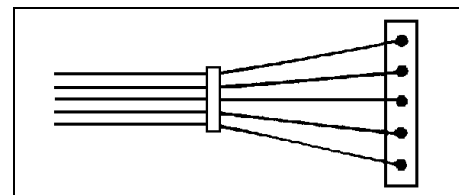
### 6.14.2 Location and arrangement

- **6.14.2.1 Test points for units of equipment.** A test point should be provided for each input to and output from a unit of equipment.
- **6.14.2.2 Arranging test points.** When testing complexity warrants, test points shall be arranged on a single control panel or on a series of functionally autonomous panels.
- **6.14.2.3 Tracing signals.** Test points should be provided to permit the systematic tracing of signals and voltages through a unit of equipment. These test points allow a maintainer to determine the point at which signals or voltages in a malfunctioning unit are out of tolerance.
- **6.14.2.4 Test and service point accessibility.** All test and service points shall be physically and visually accessible to the maintainer.
- **6.14.2.5 Proximity to associated controls and displays.** Test and service points shall be located in physical and visual proximity to the controls and displays used to make the adjustments associated with the points.
- **6.14.2.6 Test and service point location.** Test and service points should be provided, designed, and located in accordance with

their frequency of use and any applicable time limits on maintenance activities.

- **6.14.2.7 Minimizing testing and servicing.** Requirements for periodic or repetitive testing and servicing of components should be avoided if possible by using sealed bearings, oil impregnated bushings, highly reliable components, and the like.
- **6.14.2.8 Minimizing test and service points.** To reduce the number of test and service points required, built-in indicators, center reading meters, pressure gauges, direct reading fluid level gauges, and the like shall be used for quick checks, thus avoiding the need for auxiliary equipment.
- **6.14.2.9 Avoid isolated test or service points.** Isolated test or service points should be avoided; such points are likely to be overlooked or neglected.
- **6.14.2.10 Compatibility of test and service points.** Test and service points shall be designed for compatibility with checking, troubleshooting, and servicing procedures and with test and service equipment.
- **6.14.2.11 Distinctive connections.** Distinctively different connectors or fittings should be provided for each type of test or service equipment (for example, grease and oil fittings should be distinctively different from each other) to minimize the likelihood of error.
- **6.14.2.12 Avoid separate accessories.** Separate funnels, strainers, adapters, and other accessories should be avoided. Where practical, these accessories should be built into the equipment or the service equipment, so that they need not be handled separately.
- **6.14.2.13 Terminal strips.** If special test points are not provided on electrical equipment, cables should be fanned out on terminal strips as illustrated in exhibit 6.14.2.13.

**Exhibit 6.14.2.13** Terminal strips



### 6.14.3 Drain points

- **6.14.3.1 Drain provisions.** Drains shall be provided on all fluid tanks and systems, fluid filled cases, filter systems, float chambers, and other items that are likely to contain fluid that would otherwise be difficult to remove.
- **6.14.3.2 Minimization.** The number of types and sizes of drain fittings should be minimized and standardized throughout the system.

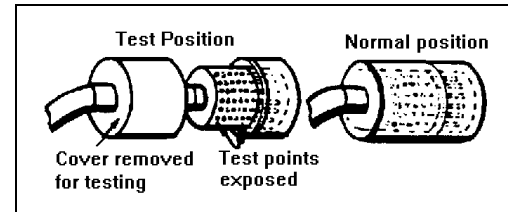
- **6.14.3.3 Valves and petcocks versus drain plugs.** Whenever practical, valves or petcocks should be used rather than drain plugs.
- **6.14.3.4 Drain plugs.** Drain plugs shall require only common hand tools for operation, and their placement shall ensure adequate tool and work clearance for operation.
- **6.14.3.5 Labels.** Drain cocks or valves shall be clearly labeled to indicate open and closed positions, and the direction of movement required for opening.
- **6.14.3.6 Drain cock motions.** Drain cocks shall always close with clockwise motion and open with counterclockwise motion.
- **6.14.3.7 Instruction labels.** Instruction labels shall be provided, as necessary, to ensure that the fluid system is properly prepared prior to draining.
- **6.14.3.8 Accessibility.** As applicable, drain points shall be designed, located, and installed:
  - a. where they are reachable and operable by the maintainer,
  - b. so that fluid will not drain or spill on equipment or personnel,
  - c. at the lowest point in the system if complete draining is required,
  - d. to permit selective draining or bleeding to facilitate maintenance procedures,
  - e. to permit drainage directly into a waste container without use of separate adapters or piping, and
  - f. so that fuel or other combustible fluids cannot run down to or collect in hazardous areas.

#### 6.14.4 Accessibility

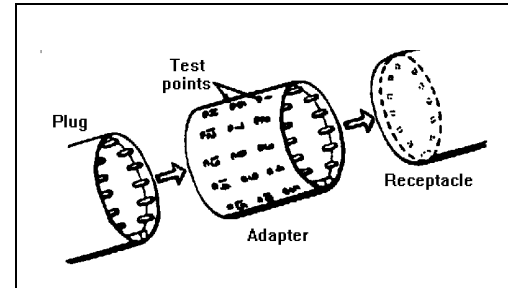
- **6.14.4.1 Test and service point accessibility.** Test and service points shall be easily accessible for checking and troubleshooting. Recommended minimum clearances are 19 mm (0.75 in) when only finger control is required, and 75 mm (3 in) when the gloved hand is used.
- **6.14.4.2 Test probe guides.** Suitable guides for test probes should be provided when test points are located internally.
- **6.14.4.3 Test accesses.** Test accesses should be provided for mechanical components likely to wear. For example, brake assemblies should be provided with an inspection opening to permit insertion of a gauge for determining the clearance between the brake lining and drum.

- **6.14.4.4 Test points in plugs.** If appropriate, plugs with integral test points for each input and output shall be used. If dust or moisture is a factor, an integral sliding cover for the test points shall be provided on the plug, as shown in exhibit 6.14.4.4 (a). An acceptable alternative is the provision of a test-point adapter for insertion between a plug and its receptacle, as shown in exhibit 6.14.4.4 (b) (see also paragraph 6.8.5.1.13).

**Exhibit 6.14.4.4 (a)** Test plug with sliding cover



**Exhibit 6.14.4.4 (b)** Test point adapter



## 6.14.5 Safety

- **6.14.5.1 Test point shielding.** All test points shall be located or shielded to protect the maintainer against contact with high voltages.
- **6.14.5.2 Minimum clearance.** Test and service points shall be separated by more than a hand's width, 114 mm (4.5 in), from the nearest hazard.
- **6.14.5.3 Recessed test and service points.** Test and service points should be recessed to protect them from damage by personnel, dust, moisture, and the like.
- **6.14.5.4 High pressure test indicators.** High pressure test indicators should be used wherever possible to avoid some of the hazards associated with making temporary high pressure connections.
- **6.14.5.5 Ground points.** If a good grounding point is not available, a special "ground" point shall be provided. Connection to this special ground point shall be made during tests of a given unit.

**Discussion.** Maintainers may have difficulty if only painted surfaces are available for ground connections.

- **6.14.5.6 Shields around lubrication points.** Shields should be provided around lubrication points that may be serviced while equipment is operating.

### 6.14.6 Labeling, marking, and coding

- **6.14.6.1 Label location.** Labels for test and service points shall be in full view of the maintainer making connections or adjustments.
- **6.14.6.2 Distinguishable marking.** Test and service points shall be designed and marked so that they are easily distinguishable, for example, by coding them with distinctive colors.
- **6.14.6.3 Distinguishing test and service points.** If color coding is used, the color of test points shall be clearly different from the color of service points.
- **6.14.6.4 Hazardous points.** Hazardous test and service points shall be labeled to warn maintainers about any possible injury to themselves or damage to internal circuits.
- **6.14.6.5 Identification of test points.** Each test point shall be clearly labeled with a number, letter, symbol, or description of its function or, at a minimum, with a code number keyed to the user documentation.
- **6.14.6.6 Luminescent markings.** If test points must be read under very low ambient illumination, they should be marked in phosphorescent colors.
- **6.14.6.7 Tolerance limits.** Each test point should be labeled with the tolerance limits of the signal to be measured there.
- **6.14.6.8 Internal test and service points.** When a test or service point is located internally, its location shall be indicated on the cover or adjacent to its access opening on the surface of the equipment.

## 6.15 Test equipment

This section contains general criteria and guidelines for test equipment and specific criteria and guidelines for four types of test equipment: (1) built-in, (2) go, no-go, (3) automatic, and (4) collating. Bench mockups and storage for test equipment are also addressed.

**Definitions.** **Built-in test equipment** is an integral part of a unit of equipment and can range from a simple voltmeter to a complex automatic checker. **Go, no-go test equipment** provides one of two alternative answers to any question. For example, it tells whether a given signal is in or out of tolerance. **Automatic test equipment** checks two or more signals in sequence without the intervention of a maintainer. The test usually stops when the first out-of-tolerance signal is detected. **Collating test equipment** presents the results of two or more checks as a single display; for example, a light might come on only if a number of different signals are in tolerance.

### 6.15.1 General

Test equipment is intended to: (1) simplify the job of the maintainer, (2) reduce the preparation or turn-around time for installing, maintaining, and repairing systems, and (c) reduce total maintenance costs. It needs to be fast, easy, and safe to use.

The type of test equipment is decided upon in the early stages of equipment design. Selection of test equipment depends on: (1) the mission and operational characteristics of the equipment, (2) the anticipated reliability of the equipment, (3) the maintenance concept, (4) the available personnel, (5) the operational environment, (6) the logistics support requirements, and (7) the development time and cost.

#### 6.15.1.1 General characteristics

The following general criteria and guidelines are aimed at simplifying the maintainers' job.

- **6.15.1.1.1 Test equipment treatment.** Test equipment and bench mockups shall be treated like any other equipment with respect to design requirements for units, covers, cases, cables, connectors, test points, displays, and controls.
- **6.15.1.1.2 Accuracy of test equipment.** The accuracy of all test equipment shall exceed that of the equipment being tested.
- **6.15.1.1.3 Conversion tables.** Conversion tables shall not be used in deciding if equipment is within tolerances.
- **6.15.1.1.4 Selector switches.** Selector switches should be used rather than multiple plug-in connections as long as the effects of switching do not degrade the desired information.
  - Discussion.** Selector switches can be used more quickly than plug-in connections, and they reduce the likelihood of faulty connections.
- **6.15.1.1.5 Maintenance instructions.** Clear operating and maintenance instructions shall be prepared and available to the maintainer.
- **6.15.1.1.6 Storing instructions.** Full instructions shall be stored inside the test equipment's cover or case, if any, or attached to a metal plate containing a checklist for operating the equipment.
- **6.15.1.1.7 Labeling.** The outer case and all removable parts should be clearly labeled with the equipment identification, including its purpose and any precautions that should be observed in using it.
- **6.15.1.1.8 Label contents.** The label shall contain all items the maintainer must be able to recognize, read, or use.

#### 6.15.1.2 Safety

- **6.15.1.2.1 Shielding hazardous parts.** Test equipment shall be designed so that all exposed moving and cutting parts are shielded to prevent maintainer injuries during maintenance tasks.



- **6.15.1.2.2 Safeguarding the circuit.** Fuses shall be provided that safeguard the circuit if a wrong switch or jack position is used.
- **6.15.1.2.3 Covering exposed parts.** Protrusions, rails, and corners on test equipment with which maintainers might come into contact should be covered with rubber or other appropriate materials.
- **6.15.1.2.4 Warning of errors.** If possible, the test equipment shall be designed either to prevent the maintainer from making errors or to warn him or her of potential or actual errors.
- **6.15.1.2.5 Minimizing hazards.** When possible, fail-safe features should be incorporated in test equipment to minimize any danger to maintainers or equipment.
- **6.15.1.2.6 Internal controls.** Internal controls shall be located away from dangerous voltages.
- **6.15.1.2.7 Safeguarding high voltages.** High voltage areas shall be insulated or shielded.
- **6.15.1.2.8 Warning labels.** Adequate warnings shall be provided wherever potential hazards exist.

### 6.15.1.3 Ease of use

- **6.15.1.3.1 Accessibility.** Adjustment points, test points, cables, connectors, and labels for all required maintenance tasks shall be visually and physically accessible. Access openings necessary to connect test equipment using required tools shall accommodate maintainers and equipment as specified in section 6.4.3 and paragraph 6.14.4.1.
- **6.15.1.3.2 Minimizing test equipment.** The number and types of test equipment and accessories, such as connectors and test cables, should be minimized.
- **6.15.1.3.3 Ease of use.** Equipment should be simple to operate, have self-checking and calibrating features, and have a minimum number of controls and displays.
- **6.15.1.3.4 Reducing the number and complexity of steps.** The number and complexity of steps should be reduced by grouping controls (such as by sequence or criticality) or by making certain operations automatic.
- **6.15.1.3.5 Individual operation.** Test equipment should be designed for operation by one person.

### 6.15.1.4 Controls and displays

- **6.15.1.4.1 Calibration check.** Test equipment should be easily calibrated or equipped with a simple check (for example, a go,

no-go indicator) to indicate whether or not the test equipment is out of calibration or is malfunctioning.

- **6.15.1.4.2 Warm-up indicators.** A warm-up indicator should be provided, if applicable, to show when the test equipment is warmed up and ready to use. If such a signal cannot be provided, a label near the warm-up switch should state clearly how much warm-up time is required.
- **6.15.1.4.3 Automatic shutoff switches.** If feasible, test equipment should have an automatic shutoff. If it is not feasible, test equipment should have both warning lights and written warnings to remind the maintainer to turn the equipment off when finished.
- **6.15.1.4.4 Misalignment.** Controls and displays should be designed to prevent misalignment that might be caused by vibration, service use, or accidental contact.

### 6.15.2 Built-in test equipment (including partially built-in, portable, and test panels)

The advantages of built-in test equipment include: (1) being less likely than portable test equipment to be lost or damaged, (2) being available when needed, and (3) requiring no special storage facilities.

The disadvantages of built-in test equipment include: (1) adding to the weight and space requirements of the equipment being tested, (2) requiring more built-in test equipment because a separate item is usually required for each unit of equipment, (3) transporting built-in test equipment to a point for convenient calibration may be more difficult than transporting portable test equipment, and (4) installing test equipment permanently may increase the complexity of wiring for the system and may even increase the amount of maintenance activity.

**Definition. Built-in test equipment** is an integral part of a unit of equipment and can range from a simple voltmeter to a complex automatic checker.

#### 6.15.2.1 Completely built-in test equipment

- **6.15.2.1.1 Combining test points.** If a unit of equipment has built-in test capabilities, all maintenance tests should be performed with the built-in test unit.
- **6.15.2.1.2 Efficiency.** If possible, built-in test units should be integrated into the equipment for efficient maintenance and troubleshooting.

**Discussion.** If voltages and wave shapes must be checked, for example, the test unit might consist of a meter, an oscilloscope, and a rotary switch for selecting circuits.

- **6.15.2.1.3 Easy to use.** Meters and oscilloscopes should have fixed, preset circuits so that the meter always reads center scale and the oscilloscope requires no adjustment.
- **6.15.2.1.4 In-tolerance.** Either an in-tolerance meter reading or an in-tolerance waveshape on the oscilloscope should be coded for each position of the rotary switch. If more test points are needed than can be handled by a single switch, multiple switches can be used.

### 6.15.2.2 Partially built-in test equipment

- **6.15.2.2.1 Combining test points.** If possible, all test points should be incorporated into one built-in unit of test equipment.
- **6.15.2.2.2 Test capabilities.** To the extent feasible, all the test capabilities described in section 6.15.2.1 should be built-in.

**Example.** A center-reading meter might be mounted on each major component that can be checked by a meter, and a set of test jacks might be provided as an outlet for signals requiring an oscilloscope.

### 6.15.2.3 Portable test equipment

- **6.15.2.3.1 When to use.** If it is not practical to incorporate all test points into one unit of built-in test equipment or to provide a center-reading meter and test jacks for an external oscilloscope, a portable test unit shall be provided.
- **6.15.2.3.2 Single connection.** Portable test equipment shall connect to its associated unit of equipment or partially built-in test equipment through a single, multi-prong connector.
- **6.15.2.3.3 Internal storage.** Portable test equipment shall have enough storage space in its handling case or lid to contain leads, probes, spares, and any special tools required for operation.
- **6.15.2.3.4 Operating instructions.** Instructions for operating portable test equipment shall be provided on the face of the test equipment, on its case or cover, if any, or in a special storage compartment in the test. These instructions shall be easily readable by the maintainer while the test equipment is being operated. If applicable, the instructions shall include a reminder to calibrate the equipment and instructions for calibration.
- **6.15.2.3.5 Calibration records.** If applicable, a placard shall be attached to the equipment for recording calibration information, including tolerance check values.

#### 6.15.2.4 Built-in test panel

- **6.15.2.4.1 When to use.** If built-in, partially built-in, or portable test units are not practical, a test panel should be provided on the equipment.
- **6.15.2.4.2 Test point connections.** Test points shall permit the connection of appropriate test equipment, such as voltage meters or oscilloscopes.
- **6.15.2.4.3 Block diagram.** When applicable, the test points on a test panel should be arranged within a miniature block diagram of the system, with each block representing components or units of equipment.
- **6.15.2.4.4 Overlays.** Overlays for the test panel should be provided to direct the maintainer to test points that should be checked and the order in which they should be checked. Instructions should be provided in the user documentation.
- **6.15.2.4.5 Tolerance limits for signals.** Tolerance limits for signals should be shown on overlays, and test points should be coded on the test panel. Full instructions should be provided in user documentation so that they are still available in the event an overlay is lost.

#### 6.15.3 Go, no-go test equipment

The advantages of go, no-go test equipment include: (1) presenting information in a clear, unambiguous manner and (2) simplifying difficult tasks, such as balancing circuits and checking complex waveshapes.

The disadvantages include: (1) requiring unique circuitry for each signal value to be tested (sometimes, however, ordinary displays can be converted to go, no-go displays by appropriate use of reference scales such as a colored section on a meter dial), (2) increasing the number and complexity of circuits required, which will probably add to initial cost and development time and increase the rate of test equipment breakdown, (3) providing relatively little help to the maintainer in checking common voltages or simple waveshapes, and (4) requiring a special model for many or most units of equipment.

**Definition.** **Go, no-go test equipment** provides one of two alternative answers to any question. For example, it tells whether a given signal is in or out of tolerance.

#### 6.15.4 Automatic test equipment

An advantage of automatic test equipment is that it can make a rapid sequence of checks with little or no chance of omitting steps.

Disadvantages of automatic test equipment include: (1) it can be relatively expensive, large, and heavy, and it may require maintenance of itself, (2) it can be relatively specialized, with little versatility, (3) it can require self-checking features to detect test equipment malfunctioning, which adds to cost and to

problems of maintaining the test equipment, and (4) it will probably require a special model for each unit of equipment.

**Definition. Automatic test equipment** checks two or more signals in sequence without the intervention of a maintainer. Testing usually stops when the first out-of-tolerance signal is detected.

### 6.15.5 Collating test equipment

An advantage of collating test equipment is that it reduces the number of displays the maintainer must read, thereby reducing testing time and, probably, errors.

The disadvantages are similar to those for go, no-go and automatic test equipment.

**Definition. Collating test equipment** presents the results of two or more checks as a single display; for example, a "test passed" light would come on only if all of the relevant signals are in tolerance.

- **6.15.5.1 Identification of out-of-tolerance signals.** If equipment fails a test performed by collating test equipment, the test equipment should indicate which signal(s) are out of tolerance, not just that the equipment failed the test.

### 6.15.6 Bench mockups

- **6.15.6.1 Accessibility.** Adequate space shall be provided in the layout of a mockup to allow the maintainer to perform any required maintenance activities on the units.
- **6.15.6.2 Support for test equipment.** Pullout shelves or some other method of supporting the test equipment shall be provided while the test equipment is being used.
- **6.15.6.3 Extension cables.** Bench mockups shall have extension cables for all units so that the units can be removed from the bench mockup for the performance of maintenance activities (same as paragraph 6.9.1.7.1).
- **6.15.6.4 Connectors on mockup cables.** Bench mockup cables shall have connectors that require only a strong push or pull to connect and disconnect them. Bench mockup cables are not subject to strong vibration or shock, but they are connected and disconnected frequently (same as paragraph 6.9.1.7.2).
- **6.15.6.5 Coverings.** Mockup cables shall have an extra-heavy covering (for example, vinyl tubing) to protect them from wear resulting from frequent connection and disconnection (same as paragraph 6.9.1.7.3).
- **6.15.6.6 Checking signal flow.** Bench mockup cables, including extension cables for units of equipment, shall have test points to

check the signal flow through each wire (same as paragraph 6.9.1.7.4).

**Examples.** One method for accomplishing this is to provide test points at the connector; another is to provide test points on junction boxes or terminal strips.

- **6.15.6.7 Test leads.** Test leads should require no more than a fraction of a turn for attachment to the equipment being maintained.
- **6.15.6.8 Signal values.** The operating instructions for bench mockups shall include correct signal values and tolerances for each test point.
- **6.15.6.9 Covers.** Transparent, plastic covers should be used on mockup units that contain parts whose operation may be checked visually, unless a metal cover is needed for electrical shielding.
- **6.15.6.10 Easy access.** All mockup units shall be installed so that every unit is accessible without removing any other unit.

### 6.15.7 Storage space

- **6.15.7.1 Available storage.** Storage space shall be provided for removable items, for example, test leads.
- **6.15.7.2 Securing accessories.** Fasteners and holders shall be provided to hold accessories securely and safely in the storage compartment.
- **6.15.7.3 Labeling.** A label shall show the intended contents of the storage compartment and how they should be stored.
- **6.15.7.4 Handles.** If test equipment has hinged handles on the cover or case, the handles shall be recessed for convenient storage.

## 6.16 Tools

Criteria and guidelines for common hand tools and special tools are given in this section. The tools required by maintainers depend upon the nature of the maintenance tasks and the characteristics of the equipment. It is highly desirable that the need for special tools, that is, tools other than the most common types and sizes of hand tools, be eliminated or at least minimized. This goal can best be accomplished early in the equipment design process, but it deserves attention throughout design and development.

### 6.16.1 General

- **6.16.1.1 Minimize maintenance tools.** Units of equipment shall be designed to minimize the number and types of tools required to accomplish maintenance tasks (see paragraph 6.1.3.4).

- **6.16.1.2 Use common tools.** Whenever possible, units of equipment shall be designed to use common tools for maintenance (see paragraph 6.1.3.5).
- **6.16.1.3 Minimize variety and sizes of tools required.** The variety and number of different sizes of tools required shall be minimized; ideally, the tools required shall be limited to those normally found in a maintainer's tool kit.
- **6.16.1.4 Special tools.** Uncommon or specially-designed tools shall be used only when common hand tools do not satisfy the requirements or when the special tools provide a significant advantage over common hand tools. Special tools shall not be required or used without the approval of the acquisition program office (same as paragraph 6.1.3.6).

### 6.16.2 Common hand tools

- **6.16.2.1 Gripping surfaces.** Tool handles shall have adequate gripping surfaces.
- **6.16.2.2 Providing thongs.** If a tool will be used where dropping it could cause injury, damage, or significant loss of time, the tool should be provided with a thong or other means of attachment to the maintainer or the equipment.
- **6.16.2.3 Insulation of handles.** If a tool will be used in the vicinity of voltages in excess of 30 volts, the tool handle and any other part of the tool the maintainer is likely to touch shall be electrically insulated.

### 6.16.3 Special tools

- **6.16.3.1 Reasons for requiring special tools.** Special tools shall be required only when common tools cannot be used or when they are necessary to facilitate maintenance tasks, reduce time, or improve accuracy.
- **6.16.3.2 Check for existing tools.** If a special tool is needed, the designer should check any special tools that might already exist to see if one of them would suffice. If a new tool is needed, it should be as simple, practical, and universal as possible.
- **6.16.3.3 Availability of special tools.** If a special tool is required for the maintenance of a unit of equipment, the tool shall be made available at the same time as the equipment.
- **6.16.3.4 Attach to equipment.** If a unit of equipment requires a special tool for maintenance, the tool should be mounted on or attached to the equipment in a readily accessible location.
- **6.16.3.5 Temperature extremes.** If a tool will be used in extreme climates, the handles should be insulated.

- **6.16.3.6 Spark resistance.** If a tool will be used in areas where fire or explosion hazards exist, the tool shall be spark resistant.



## Section 7 contents

### 7 Human-equipment interfaces ..... 7-1

#### 7.1 Display-control integration ..... 7-1

##### 7.1.1 Basic display-control relationships ..... 7-1

- 7.1.1.1 Relationship ..... 7-1
- 7.1.1.2 No obstruction ..... 7-1
- 7.1.1.3 Complexity and precision ..... 7-1
- 7.1.1.4 Feedback ..... 7-1
- 7.1.1.5 Time lag ..... 7-1
- 7.1.1.6 Illumination ..... 7-2
- 7.1.1.7 Simultaneous access ..... 7-2
- 7.1.1.8 Emergency controls and displays ..... 7-2

##### 7.1.2 Grouping of displays and controls ..... 7-2

- 7.1.2.1 Functional grouping ..... 7-2
- 7.1.2.2 Location based on order of use ..... 7-2
- 7.1.2.3 Arrangement of groups ..... 7-2
- 7.1.2.4 Marking functional groups ..... 7-2
- 7.1.2.5 Consistency ..... 7-2
- 7.1.2.6 Location and arrangement ..... 7-2
- 7.1.2.7 Arrangement within groups ..... 7-3
- 7.1.2.8 Logical flow arrangement ..... 7-3
- 7.1.2.9 Arrangement by importance or frequency of use ..... 7-3
- 7.1.2.10 Different arrangement of controls and displays ..... 7-3
- 7.1.2.11 Vertical and horizontal arrays ..... 7-3
- 7.1.2.12 Simultaneous use ..... 7-3
- 7.1.2.13 Multiple displays ..... 7-3
- 7.1.2.14 Combined control ..... 7-3
- 7.1.2.15 Displays selected by switches ..... 7-3
- 7.1.2.16 Separated controls and displays ..... 7-4
- 7.1.2.17 Arrangement of separated controls and displays ..... 7-4
- 7.1.2.18 Correspondence of controls and displays with equipment ..... 7-4
- 7.1.2.19 Alternative techniques ..... 7-4

<b>7.1.3 Movement relationships</b>	7-4
■ 7.1.3.1 Display response to control	7-4
■ 7.1.3.2 Display response time	7-4
■ 7.1.3.3 Moving pointer, circular scale	7-4
■ 7.1.3.4 Moving pointer, linear scale	7-4
□ 7.1.3.5 Digital displays and arrays of indicator lights	7-4
■ 7.1.3.6 Fixed pointer, moving scale	7-5
■ 7.1.3.7 Fixed pointer, moving circular scale	7-5
■ 7.1.3.8 Fixed pointer, moving linear scale	7-5
■ 7.1.3.9 Direct linkage	7-5
■ 7.1.3.10 Common plane	7-5
■ 7.1.3.11 Movement direction	7-5
■ 7.1.3.12 Labeling	7-5
<b>7.1.4 Display to control movement ratio</b>	7-5
■ 7.1.4.1 Minimization of time	7-5
■ 7.1.4.2 Range of display movement	7-5
■ 7.1.4.3 Knob, coarse setting	7-6
■ 7.1.4.4 Knob, fine setting	7-6
■ 7.1.4.5 Bracketing	7-6
■ 7.1.4.6 Lever, coarse setting	7-6
■ 7.1.4.7 Lever, coarse two-dimensional setting	7-6
■ 7.1.4.8 Counters	7-6
<b>7.2 Visual displays</b>	7-6
<b>7.2.1 Principles of display</b>	7-6
<b>7.2.1.1 General</b>	7-6
□ 7.2.1.1.1 Clear indication of conditions	7-6
■ 7.2.1.1.2 Legibility	7-6
■ 7.2.1.1.3 Alerting and warning displays	7-7
■ 7.2.1.1.4 Content	7-7
■ 7.2.1.1.5 Precision	7-7
■ 7.2.1.1.6 Directly usable	7-7
■ 7.2.1.1.7 Combined operator and maintainer information	7-7
■ 7.2.1.1.8 Unnecessary markings	7-7
■ 7.2.1.1.9 Display duration	7-7
■ 7.2.1.1.10 Timeliness	7-7
■ 7.2.1.1.11 Advisory and alerting displays	7-7

<b>7.2.1.2 Display reliability and validity</b>	.....	<b>7-7</b>
■ 7.2.1.2.1 Redundancy	.....	7-8
■ 7.2.1.2.2 Display failure	.....	7-8
■ 7.2.1.2.3 Display circuit failure	.....	7-8
<b>7.2.1.3 Visual coding</b>	.....	<b>7-8</b>
■ 7.2.1.3.1 Objectives	.....	7-8
■ 7.2.1.3.2 Visual coding methods	.....	7-8
■ 7.2.1.3.3 Consistency	.....	7-8
<b>7.2.1.4 Analog and digital coding</b>	.....	<b>7-8</b>
□ 7.2.1.4.1 Analog and digital coding	.....	7-8
□ 7.2.1.4.2 When to use digital displays	.....	7-8
■ 7.2.1.4.3 When not to use digital displays	.....	7-8
□ 7.2.1.4.4 When to use analog displays	.....	7-8
<b>7.2.1.5 Visual warning and signal devices</b>	.....	<b>7-9</b>
■ 7.2.1.5.1 Alerting and warning displays	.....	7-9
□ 7.2.1.5.2 Alarm parameter selection	.....	7-9
□ 7.2.1.5.3 General alarms	.....	7-9
■ 7.2.1.5.4 Prioritization of alarms	.....	7-9
■ 7.2.1.5.5 Priority levels	.....	7-9
□ 7.2.1.5.6 Visual coding of priority levels	.....	7-9
■ 7.2.1.5.7 Audible coding of priority levels	.....	7-9
■ 7.2.1.5.8 Emergency conditions	.....	7-9
■ 7.2.1.5.9 Visual tiles	.....	7-10
■ 7.2.1.5.10 Singular in purpose	.....	7-10
■ 7.2.1.5.11 Automatic clearing of alarms	.....	7-10
■ 7.2.1.5.12 Out-of-service alarms	.....	7-10
■ 7.2.1.5.13 Testing of alarms	.....	7-10
<b>7.2.1.6 Location and arrangement</b>	.....	<b>7-10</b>
■ 7.2.1.6.1 Location	.....	7-10
□ 7.2.1.6.2 Accessibility	.....	7-10
■ 7.2.1.6.3 Orientation and parallax	.....	7-10
<b>Exhibit 7.2.1.6.3</b> Lines of sight	.....	7-11
■ 7.2.1.6.4 Reflections	.....	7-10
■ 7.2.1.6.5 Vibration	.....	7-10
□ 7.2.1.6.6 Grouping	.....	7-10
■ 7.2.1.6.7 Function and sequence	.....	7-11
□ 7.2.1.6.8 Frequently used displays	.....	7-11
<b>Exhibit 7.2.1.6.8</b> Optimum vertical and horizontal visual fields	.....	7-12

■ 7.2.1.6.9 Important or critical displays .....	7-11
■ 7.2.1.6.10 Consistency .....	7-11
■ 7.2.1.6.11 Maximum viewing distance .....	7-11
■ 7.2.1.6.12 Absolute minimum viewing distance .....	7-11
□ 7.2.1.6.13 Preferred minimum viewing distance .....	7-11
□ 7.2.1.6.14 Minimum viewing distance to CRTs .....	7-12
<b>7.2.2 Transilluminated displays</b> .....	<b>7-12</b>
<b>7.2.2.1 General</b> .....	<b>7-13</b>
□ 7.2.2.1.1 When to use .....	7-13
■ 7.2.2.1.2 Meaning of illumination .....	7-13
■ 7.2.2.1.3 Positive feedback .....	7-13
■ 7.2.2.1.4 Meaning of no illumination .....	7-13
■ 7.2.2.1.5 Grouping of indicator lights .....	7-13
■ 7.2.2.1.6 Location of transilluminated indicators .....	7-13
■ 7.2.2.1.7 Location of indicators for critical functions .....	7-13
■ 7.2.2.1.8 Maintenance displays .....	7-14
■ 7.2.2.1.9 Luminance .....	7-14
■ 7.2.2.1.10 Variable luminance .....	7-14
■ 7.2.2.1.11 False or obscured indication .....	7-14
■ 7.2.2.1.12 Contrast within an indicator .....	7-14
■ 7.2.2.1.13 Low ambient illumination .....	7-14
■ 7.2.2.1.14 Lamp redundancy .....	7-14
■ 7.2.2.1.15 Lamp testing .....	7-14
□ 7.2.2.1.16 Indicator circuit testing .....	7-15
■ 7.2.2.1.17 Removal and replacement of lamps .....	7-15
■ 7.2.2.1.18 Nonhazardous lamp replacement .....	7-15
■ 7.2.2.1.19 Proper installation of indicator covers .....	7-15
■ 7.2.2.1.20 Color coding .....	7-15
<b>Exhibit 7.2.2.1.20 Color coding of</b> transilluminated displays .....	7-16
■ 7.2.2.1.21 Flashing lights .....	7-15
<b>7.2.2.2 Legend lights</b> .....	<b>7-15</b>
■ 7.2.2.2.1 When to use .....	7-15
■ 7.2.2.2.2 Color coding .....	7-15
■ 7.2.2.2.3 Size of legend lights .....	7-15
■ 7.2.2.2.4 Illuminated label versus illuminated background .....	7-16
■ 7.2.2.2.5 Lettering of legends .....	7-16
■ 7.2.2.2.6 Visibility and legibility of lettering .....	7-16
■ 7.2.2.2.7 Multi-legend indicators .....	7-17
<b>7.2.2.3 Simple indicator lights</b> .....	<b>7-17</b>
□ 7.2.2.3.1 When to use .....	7-17
■ 7.2.2.3.2 Spacing .....	7-17
■ 7.2.2.3.3 Coding .....	7-17

	<b>Exhibit 7.2.2.3.3</b> Coding of simple indicator lights .....	7-17
<b>7.2.2.4</b>	<b>Transilluminated panel assemblies</b> .....	<b>7-18</b>
	□ 7.2.2.4.1 When to use .....	7-18
	■ 7.2.2.4.2 Large, single, pictorial graphic panels .....	7-18
	■ 7.2.2.4.3 Replacing lamps .....	7-18
	■ 7.2.2.4.4 Brightness .....	7-18
<b>7.2.3</b>	<b>Scale indicators</b> .....	<b>7-18</b>
<b>7.2.3.1</b>	<b>General</b> .....	<b>7-18</b>
	<b>Exhibit 7.2.3.1</b> Characteristics and ratings of fixed and moveable pointer scales for various uses .....	7-19
	■ 7.2.3.1.1 When to use .....	7-19
	□ 7.2.3.1.2 Type of information .....	7-19
	■ 7.2.3.1.3 Linear scales .....	7-19
	■ 7.2.3.1.4 Scale graduations .....	7-19
	■ 7.2.3.1.5 Intermediate marks .....	7-19
	■ 7.2.3.1.6 Numerals .....	7-19
	■ 7.2.3.1.7 Scale starting point .....	7-20
	□ 7.2.3.1.8 Pointer length .....	7-20
	□ 7.2.3.1.9 Pointer tip .....	7-20
	■ 7.2.3.1.10 Pointer mounting .....	7-20
	■ 7.2.3.1.11 Pointer color .....	7-20
	■ 7.2.3.1.12 Luminance contrast .....	7-20
	■ 7.2.3.1.13 Calibration information .....	7-20
	□ 7.2.3.1.14 Coding .....	7-20
	■ 7.2.3.1.15 Pattern or color coding .....	7-20
	■ 7.2.3.1.16 Use of colors .....	7-20
	□ 7.2.3.1.17 Pattern-coding .....	7-20
<b>7.2.3.2</b>	<b>Moving-pointer, fixed-scale indicators</b> .....	<b>7-20</b>
	■ 7.2.3.2.1 Numerical progression .....	7-20
	■ 7.2.3.2.2 Orientation .....	7-21
	■ 7.2.3.2.3 Scale reading and pointer movement .....	7-21
	■ 7.2.3.2.4 Zero position and direction of movement .....	7-21
	■ 7.2.3.2.5 Pointer alignment, circular scales .....	7-21
	■ 7.2.3.2.6 Scale break .....	7-21
	■ 7.2.3.2.7 Number of pointers .....	7-21
	■ 7.2.3.2.8 Pointer alignment, noncircular scales .....	7-21
	■ 7.2.3.2.9 Relative position of scale marks and numbers .....	7-21
	■ 7.2.3.2.10 Placement of pointers .....	7-21
	■ 7.2.3.2.11 Placement of numbers .....	7-22

<b>7.2.3.3 Fixed-pointer moving-scale indicators</b>	.....	<b>7-22</b>
■ 7.2.3.3.1 When to use	.....	7-22
■ 7.2.3.3.2 Numerical progression	.....	7-22
■ 7.2.3.3.3 Orientation	.....	7-22
■ 7.2.3.3.4 Alignment of pointer or fixed reference line	.....	7-22
■ 7.2.3.3.5 Setting	.....	7-22
■ 7.2.3.3.6 Tracking	.....	7-22
□ 7.2.3.3.7 Moving tape displays	.....	7-22
■ 7.2.3.3.8 Composite scalar and pictorial displays	.....	7-22
<b>7.2.4 Cathode ray tube displays</b>	.....	<b>7-23</b>
<b>7.2.4.1 General</b>	.....	<b>7-23</b>
■ 7.2.4.1.1 Refresh rate	.....	7-23
□ 7.2.4.1.2 Screen phosphor and persistence	.....	7-23
□ 7.2.4.1.3 Geometric distortion	.....	7-23
■ 7.2.4.1.4 Chromatic aberration	.....	7-23
■ 7.2.4.1.5 Luminance	.....	7-23
<b>7.2.4.2 Color</b>	.....	<b>7-23</b>
□ 7.2.4.2.1 Preferred colors	.....	7-23
□ 7.2.4.2.2 Color saturation	.....	7-23
□ 7.2.4.2.3 Color coding	.....	7-23
■ 7.2.4.2.4 Limitations of color usage	.....	7-24
<b>7.2.4.3 Ambient illumination</b>	.....	<b>7-24</b>
■ 7.2.4.3.1 Screen luminance	.....	7-24
■ 7.2.4.3.2 Faint signals	.....	7-24
■ 7.2.4.3.3 Luminance range of adjacent surfaces	.....	7-24
■ 7.2.4.3.4 Ambient illuminance	.....	7-24
□ 7.2.4.3.5 Medium to high ambient illumination	.....	7-25
<b>7.2.4.4 Glare control</b>	.....	<b>7-25</b>
■ 7.2.4.4.1 Glare	.....	7-25
■ 7.2.4.4.2 Adjacent surfaces	.....	7-25
□ 7.2.4.4.3 Avoiding reflected glare	.....	7-25
□ 7.2.4.4.4 Etched filters	.....	7-25
<b>7.2.4.5 Viewing distance, angle, and screen orientation</b>		
■ 7.2.4.5.1 Viewing distance	.....	7-25
□ 7.2.4.5.2 Variable viewing distance	.....	7-26

	□ 7.2.4.5.3 Viewing angle and screen orientation .....	7-26
	■ 7.2.4.5.4 Visual display terminals for office environments ....	7-26
<b>7.2.4.6 Alphanumeric character displays</b>	.....	<b>7-26</b>
	■ 7.2.4.6.1 Font legibility .....	7-26
	■ 7.2.4.6.2 Character size (height) .....	7-26
	<b>Exhibit 7.2.4.6.2</b> Minimum alphanumeric character height; as a fraction of viewing distance and, height at a viewing distance of 457 mm (18 in) .....	7-26
	■ 7.2.4.6.3 Luminance contrast .....	7-27
	□ 7.2.4.6.4 Medium to high ambient illumination .....	7-27
	■ 7.2.4.6.5 Resolution .....	7-27
<b>7.2.4.7 Symbolic and pictographic coding and displays</b>	.....	<b>7-27</b>
	■ 7.2.4.7.1 Pictorial and graphic situation formats .....	7-27
	□ 7.2.4.7.2 Signal size .....	7-27
	□ 7.2.4.7.3 Resolution .....	7-27
	□ 7.2.4.7.4 Display updating .....	7-27
	■ 7.2.4.7.5 Character height-to-width ratio .....	7-27
	□ 7.2.4.7.6 Stroke width .....	7-28
	■ 7.2.4.7.7 Spacing between characters .....	7-28
	■ 7.2.4.7.8 Spacing between words .....	7-28
	■ 7.2.4.7.9 Spacing between lines .....	7-28
<b>7.2.5 Large-screen displays</b>	.....	<b>7-28</b>
<b>7.2.5.1 General</b>	.....	<b>7-28</b>
	□ 7.2.5.1.1 When to use .....	7-28
	■ 7.2.5.1.2 When not to use .....	7-28
	■ 7.2.5.1.3 Viewing distance .....	7-28
	■ 7.2.5.1.4 Physical interruption of view .....	7-29
	■ 7.2.5.1.5 Control of displayed information .....	7-29
	■ 7.2.5.1.6 Content of displayed information .....	7-29
	■ 7.2.5.1.7 Minimum matrix .....	7-29
	■ 7.2.5.1.8 Character size .....	7-29
	□ 7.2.5.1.9 Luminance .....	7-29
	□ 7.2.5.1.10 Character size and luminance .....	7-29
	□ 7.2.5.1.11 Character aspect ratio .....	7-29
	□ 7.2.5.1.12 Modulation depth .....	7-29
	□ 7.2.5.1.13 Polarity .....	7-29
	□ 7.2.5.1.14 Background for colored objects .....	7-29
<b>7.2.5.2 Large-screen optical projection displays</b>	.....	<b>7-30</b>
	■ 7.2.5.2.1 When to use .....	7-30

■ 7.2.5.2.2 Viewing distance and screen size .....	7-30
■ 7.2.5.2.3 Viewing angle .....	7-30
■ 7.2.5.2.4 Image luminance and light distribution .....	7-30
■ 7.2.5.2.5 Character style .....	7-30
■ 7.2.5.2.6 Character size .....	7-31
□ 7.2.5.2.7 Luminance ratio .....	7-31
■ 7.2.5.2.8 Minimum luminance ratio .....	7-31
■ 7.2.5.2.9 Superimposed images .....	7-31
■ 7.2.5.2.10 Alignment .....	7-31
■ 7.2.5.2.11 Minimizing distortion .....	7-31
□ 7.2.5.2.12 Projection displays .....	7-31
□ 7.2.5.2.13 Reflected luminance of screen .....	7-31
□ 7.2.5.2.14 Alternative projection methods .....	7-31
<b>7.2.6 Dot matrix and segmented displays .....</b>	<b>7-32</b>
■ 7.2.6.1 Seven-segment displays .....	7-32
■ 7.2.6.2 Matrix size .....	7-32
■ 7.2.6.3 Visual angle .....	7-32
□ 7.2.6.4 Viewing angle .....	7-32
■ 7.2.6.5 Emitter color .....	7-32
■ 7.2.6.6 Intensity control .....	7-32
<b>7.2.7 Light emitting diodes .....</b>	<b>7-32</b>
■ 7.2.7.1 General .....	7-32
□ 7.2.7.2 When to use .....	7-32
□ 7.2.7.3 Intensity control .....	7-33
■ 7.2.7.4 Color coding .....	7-33
■ 7.2.7.5 Testing .....	7-33
■ 7.2.7.6 Location of red alphanumeric LEDs and segmented displays .....	7-33
<b>7.2.8 Special displays .....</b>	<b>7-33</b>
<b>7.2.8.1 Flat-panel displays .....</b>	<b>7-33</b>
□ 7.2.8.1.1 Character formation -- vertical orientation .....	7-33
□ 7.2.8.1.2 Character formation -- nonvertical orientation .....	7-33
□ 7.2.8.1.3 Character stroke width .....	7-33
<b>Exhibit 7.2.8.1.3</b> Stroke width for pixel-generated characters .....	7-33
□ 7.2.8.1.4 Character height-width relationship .....	7-34
<b>Exhibit 7.2.8.1.4</b> Height-width relationship for pixel-generated characters .....	7-34
□ 7.2.8.1.5 Image formation time .....	7-34



□ 7.2.8.1.6 Pixel failure rate .....	7-34
□ 7.2.8.1.7 Text redundancy to counteract display element failure .....	7-34
□ 7.2.8.1.8 Display polarity .....	7-34
□ 7.2.8.1.9 First-surface treatment for flat panel displays .....	7-34
<b>7.2.8.2 Liquid crystal displays</b> .....	<b>7-34</b>
□ 7.2.8.2.1 Ambient illumination .....	7-35
□ 7.2.8.2.2 Polarity .....	7-35
□ 7.2.8.2.3 Minimize backlighting .....	7-35
□ 7.2.8.2.4 Low ambient illumination .....	7-35
□ 7.2.8.2.5 Minimize off-axis of backlit LCDs .....	7-35
<b>7.2.8.3 Gas plasma displays</b> .....	<b>7-35</b>
□ 7.2.8.3.1 Prototypes .....	7-35
□ 7.2.8.3.2 Verified by users .....	7-35
<b>7.2.8.4 Electroluminescent displays</b> .....	<b>7-35</b>
■ 7.2.8.4.1 Applicable guidelines .....	7-35
■ 7.2.8.4.2 Alphanumeric character and symbol size .....	7-35
□ 7.2.8.4.3 Prototyping .....	7-36
□ 7.2.8.4.4 Verified by users .....	7-36
<b>7.2.8.5 Stereoscopic displays</b> .....	<b>7-36</b>
□ 7.2.8.5.1 Meaningful use .....	7-36
□ 7.2.8.5.2 No performance degradation .....	7-36
□ 7.2.8.5.3 No interocular crosstalk .....	7-36
□ 7.2.8.5.4 Color in three-dimensional displays .....	7-36
□ 7.2.8.5.5 Dynamic displays .....	7-36
□ 7.2.8.5.6 Spatial separation of depth-coded objects .....	7-36
□ 7.2.8.5.7 Size scaling .....	7-36
□ 7.2.8.5.8 Luminance and depth .....	7-36
<b>7.2.8.6 Touch- interactive devices</b> .....	<b>7-37</b>
□ 7.2.8.6.1 Minimal parallax .....	7-38
□ 7.2.8.6.2 Minimal specular glare .....	7-38
<b>7.2.9 Counters, printers, and flags displays</b> .....	<b>7-38</b>

	<b>Exhibit 7.2.9</b> Characteristics and ratings of counters, printers, and flags for various uses .....	7-38
<b>7.2.9.1</b>	<b>Counters</b> .....	<b>7-38</b>
	□ 7.2.9.1.1 When to use .....	7-38
	■ 7.2.9.1.2 Mounting .....	7-39
	■ 7.2.9.1.3 Movement .....	7-39
	■ 7.2.9.1.4 Illumination .....	7-39
	■ 7.2.9.1.5 Spacing between numerals .....	7-39
	■ 7.2.9.1.6 Finish .....	7-39
	■ 7.2.9.1.7 Contrast .....	7-39
<b>7.2.9.2</b>	<b>Printers and alphanumeric hard copy displays</b> .....	<b>7-39</b>
	□ 7.2.9.2.1 When to use .....	7-39
	■ 7.2.9.2.2 Contrast .....	7-39
	■ 7.2.9.2.3 Illumination .....	7-39
	■ 7.2.9.2.4 Take-up provision .....	7-40
	□ 7.2.9.2.5 Annotation .....	7-40
	■ 7.2.9.2.6 Legibility .....	7-40
	■ 7.2.9.2.7 Printed edges .....	7-40
	■ 7.2.9.2.8 Control, replenishment, and service .....	7-40
<b>7.2.9.3</b>	<b>Plotters, recorders, and graphic data hard copy displays</b> .....	<b>7-40</b>
	□ 7.2.9.3.1 When to use .....	7-40
	■ 7.2.9.3.2 Visibility .....	7-40
	■ 7.2.9.3.3 Contrast .....	7-40
	■ 7.2.9.3.4 Take-up provision .....	7-40
	■ 7.2.9.3.5 Job aids .....	7-41
	■ 7.2.9.3.6 Smudging and smearing .....	7-41
	■ 7.2.9.3.7 Annotation .....	7-41
	■ 7.2.9.3.8 Control, replenishment, and service .....	7-41
<b>7.2.9.4</b>	<b>Flags</b> .....	<b>7-41</b>
	□ 7.2.9.4.1 When to use .....	7-41
	■ 7.2.9.4.2 Mounting .....	7-41
	■ 7.2.9.4.3 Snap action .....	7-41
	■ 7.2.9.4.4 Contrast .....	7-41
	■ 7.2.9.4.5 Malfunction indication .....	7-41
	■ 7.2.9.4.6 Legend .....	7-41
	■ 7.2.9.4.7 Test provision .....	7-42

<b>7.3 Audio displays</b>	7-42
<b>7.3.1 General</b>	7-42
□ 7.3.1.1 Single audio displays	7-42
□ 7.3.1.2 When to use	7-42
□ 7.3.1.3 Signal type	7-42
<b>Exhibit 7.3.1.3 Characteristics and ratings of audio signals for various uses</b>	7-43
■ 7.3.1.4 False alarms	7-42
■ 7.3.1.5 Failure	7-42
■ 7.3.1.6 Circuit operability test	7-42
■ 7.3.1.7 Redundant visual warning	7-43
<b>7.3.2 Audio warnings and signals</b>	7-43
<b>7.3.2.1 General</b>	7-43
□ 7.3.2.1.1 General	7-43
■ 7.3.2.1.2 Alerting and warning system	7-44
<b>7.3.2.2 Characteristics of warning signals</b>	7-44
□ 7.3.2.2.1 Nature of signals	7-44
■ 7.3.2.2.2 Two-element signals	7-44
■ 7.3.2.2.3 Single-element signal	7-44
■ 7.3.2.2.4 Caution signals	7-44
■ 7.3.2.2.5 Relation to visual displays	7-44
■ 7.3.2.2.6 Frequency range	7-44
■ 7.3.2.2.7 Spurious signals	7-44
■ 7.3.2.2.8 Audibility	7-44
■ 7.3.2.2.9 Compatibility with clothing and equipment	7-44
<b>7.3.2.3 Signal characteristics versus operational conditions and objectives</b>	7-45
■ 7.3.2.3.1 Audibility	7-45
■ 7.3.2.3.2 Maximum intensity	7-45
□ 7.3.2.3.3 Attention	7-45
□ 7.3.2.3.4 Onset and sound pressure level	7-45
□ 7.3.2.3.5 Dichotic presentation	7-45
■ 7.3.2.3.6 Headset	7-45
□ 7.3.2.3.7 When not to use headsets	7-45
■ 7.3.2.3.8 Multiple audio signals	7-46
■ 7.3.2.3.9 Coding	7-46

■ 7.3.2.3.10 Differentiation from routine signals .....	7-46
□ 7.3.2.3.11 Consistent signals .....	7-46
■ 7.3.2.3.12 Acoustic environment .....	7-46
■ 7.3.2.3.13 Noninterference .....	7-46
□ 7.3.2.3.14 Separate channels .....	7-46
<b>7.3.3 Verbal warning signals .....</b>	<b>7-46</b>
■ 7.3.3.1 Nature of signals .....	7-46
■ 7.3.3.2 Intensity .....	7-47
■ 7.3.3.3 Type of voice .....	7-47
■ 7.3.3.4 Delivery style .....	7-47
■ 7.3.3.5 Speech processing .....	7-47
■ 7.3.3.6 Message content .....	7-47
■ 7.3.3.7 Critical warning signals .....	7-47
■ 7.3.3.8 Message priorities .....	7-47
<b>7.3.4 Controls for audio warning devices .....</b>	<b>7-47</b>
<b>7.3.4.1 General .....</b>	<b>7-47</b>
■ 7.3.4.1.1 Automatic and manual shutoff .....	7-47
■ 7.3.4.1.2 Automatic reset .....	7-48
<b>7.3.4.2 Volume control and duration .....</b>	<b>7-48</b>
■ 7.3.4.2.1 Control of volume .....	7-48
■ 7.3.4.2.2 Ganging to mode switches .....	7-48
■ 7.3.4.2.3 Caution signal controls .....	7-48
■ 7.3.4.2.4 Duration .....	7-48
■ 7.3.4.2.5 Duration limitations .....	7-48
<b>7.3.5 Voice communication systems .....</b>	<b>7-48</b>
<b>7.3.5.1 Speech transmission equipment .....</b>	<b>7-48</b>
■ 7.3.5.1.1 Frequency range .....	7-48
■ 7.3.5.1.2 Dynamic range .....	7-49
■ 7.3.5.1.3 Noise cancelling microphones .....	7-49
■ 7.3.5.1.4 Pre-emphasis .....	7-49
□ 7.3.5.1.5 Noise shields .....	7-49

<b>7.3.5.2 Speech reception equipment</b>	.....	<b>7-49</b>
■ 7.3.5.2.1 Frequency range	.....	7-49
■ 7.3.5.2.2 Use of de-emphasis	.....	7-50
■ 7.3.5.2.3 Monitoring of speakers	.....	7-50
■ 7.3.5.2.4 Filtering of speaker signals	.....	7-50
■ 7.3.5.2.5 Use of binaural headsets	.....	7-50
□ 7.3.5.2.6 Binaural headsets	.....	7-50
<b>7.3.5.3 Design for maintainer comfort and convenience</b>	.....	<b>7-50</b>
■ 7.3.5.3.1 Comfort	.....	7-50
■ 7.3.5.3.2 Hands-free operation	.....	7-50
■ 7.3.5.3.3 Accessibility of handsets	.....	7-50
<b>7.3.5.4 Operating controls for voice communication equipment</b>	.....	<b>7-51</b>
■ 7.3.5.4.1 Volume controls	.....	7-51
□ 7.3.5.4.2 Separate controls for power and volume	.....	7-51
■ 7.3.5.4.3 Combined power and volume controls	.....	7-51
■ 7.3.5.4.4 Squelch control	.....	7-51
■ 7.3.5.4.5 Foot-operated controls	.....	7-51
■ 7.3.5.4.6 Duplicate emergency controls	.....	7-51
■ 7.3.5.4.7 Speaker and side tone	.....	7-51
<b>7.3.5.5 Conventional telephone systems</b>	.....	<b>7-52</b>
■ 7.3.5.5.1 General	.....	7-52
■ 7.3.5.5.2 Cords	.....	7-52
■ 7.3.5.5.3 Handset cradles	.....	7-52
■ 7.3.5.5.4 Multiple telephones	.....	7-52
■ 7.3.5.5.5 Press-to-talk button	.....	7-52
□ 7.3.5.5.6 Switching	.....	7-52
■ 7.3.5.5.7 Priority	.....	7-52
□ 7.3.5.5.8 Noisy environments	.....	7-52
<b>7.3.5.6 Speech intelligibility</b>	.....	<b>7-52</b>
□ 7.3.5.6.1 Evaluation method	.....	7-52
■ 7.3.5.6.2 Intelligibility criteria	.....	7-53
<b>Exhibit 7.3.5.6.2</b> Speech intelligibility criteria for various communication requirements and evaluation methods	.....	7-53

<b>7.4 Controls</b>	.....	<b>7-53</b>
<b>7.4.1 General</b>	.....	<b>7-53</b>
<b>7.4.1.1 Selection of controls</b>	.....	<b>7-53</b>
■ 7.4.1.1.1 Distribution of workload	.....	7-53
■ 7.4.1.1.2 Multirotation controls	.....	7-53
■ 7.4.1.1.3 Detent stops	.....	7-53
■ 7.4.1.1.4 Limit stops	.....	7-54
□ 7.4.1.1.5 Characteristics of common controls	.....	7-54
<b>Exhibit 7.4.1.1.5 (a)</b> Characteristics of common controls for discrete adjustment	.....	7-54
<b>Exhibit 7.4.1.1.5 (b)</b> Characteristics of common controls for continuous adjustment	.....	7-55
□ 7.4.1.1.6 Advantages and disadvantages of common controls	.....	7-55
<b>Exhibit 7.4.1.1.6</b> Advantages and disadvantages of common controls	.....	7-56
<b>7.4.1.2 Direction of movement</b>	.....	<b>7-58</b>
■ 7.4.1.2.1 Consistency of movement	.....	7-58
□ 7.4.1.2.2 Valve controls	.....	7-58
■ 7.4.1.2.3 Labeling and marking valve controls	.....	7-58
<b>7.4.1.3 Arrangement and grouping</b>	.....	<b>7-58</b>
■ 7.4.1.3.1 Grouping	.....	7-58
■ 7.4.1.3.2 Sequential operation	.....	7-58
■ 7.4.1.3.3 Location of primary controls	.....	7-58
■ 7.4.1.3.4 Consistency	.....	7-58
■ 7.4.1.3.5 Remote controls	.....	7-58
■ 7.4.1.3.6 Maintenance and adjustment	.....	7-58
■ 7.4.1.3.7 Spacing	.....	7-59
<b>Exhibit 7.4.1.3.7</b> Minimum spacing between controls	.....	7-57
<b>7.4.1.4 Coding</b>	.....	<b>7-59</b>
■ 7.4.1.4.1 Methods and requirements	.....	7-59
<b>Exhibit 7.4.1.4.1</b> Advantages and disadvantages of different types of coding	.....	7-60
□ 7.4.1.4.2 Location coding	.....	7-60

<ul style="list-style-type: none"> <li> <ul style="list-style-type: none"> <li>■ 7.4.1.4.3 Size coding ..... 7-60</li> <li>■ 7.4.1.4.4 Shape coding ..... 7-60</li> <li>■ 7.4.1.4.5 Color coding ..... 7-61</li> <li>■ 7.4.1.4.6 Association of control with display ..... 7-61</li> <li>■ 7.4.1.4.7 Control panel contrast ..... 7-61</li> <li>■ 7.4.1.4.8 Ambient lighting and limitations on color coding ..... 7-61</li> </ul> </li> </ul>	
<b>7.4.1.5 Compatibility with handwear and blind operation</b>	<b>7-61</b>
<ul style="list-style-type: none"> <li> <ul style="list-style-type: none"> <li>■ 7.4.1.5.1 Compatibility with handwear ..... 7-61</li> <li>□ 7.4.1.5.2 Use of prototypes ..... 7-62</li> <li>■ 7.4.1.5.3 Blind operation ..... 7-62</li> </ul> </li> </ul>	
<b>7.4.1.6 Prevention of accidental actuation</b>	<b>7-62</b>
<ul style="list-style-type: none"> <li> <ul style="list-style-type: none"> <li>■ 7.4.1.6.1 Location and design ..... 7-62</li> <li>□ 7.4.1.6.2 Internal controls ..... 7-62</li> <li>■ 7.4.1.6.3 Rapid operation ..... 7-62</li> <li>■ 7.4.1.6.4 Methods ..... 7-62</li> <li>■ 7.4.1.6.5 "Dead man" controls ..... 7-63</li> </ul> </li> </ul>	
<b>7.4.2 Foot-operated controls</b>	<b>7-63</b>
<ul style="list-style-type: none"> <li> <ul style="list-style-type: none"> <li>□ 7.4.2.1 When to use ..... 7-63</li> <li>□ 7.4.2.2 When not to use ..... 7-63</li> <li>■ 7.4.2.3 Operation ..... 7-63</li> <li>■ 7.4.2.4 Configuration and placement ..... 7-64</li> </ul> </li> </ul>	
<b>7.4.3 Foot-operated switches</b>	<b>7-64</b>
<ul style="list-style-type: none"> <li> <ul style="list-style-type: none"> <li>■ 7.4.3.1 Foot-operated switch specifications ..... 7-64</li> <li style="padding-left: 40px;"><b>Exhibit 7.4.3.1</b> Foot-operated switch specifications ..... 7-64</li> <li>□ 7.4.3.2 When to use ..... 7-65</li> <li>■ 7.4.3.3 Operation ..... 7-65</li> <li>□ 7.4.3.4 Operation in wet or slippery conditions ..... 7-65</li> <li>■ 7.4.3.5 Feedback ..... 7-65</li> </ul> </li> </ul>	
<b>7.4.4 Hand-operated controls</b>	<b>7-65</b>
<b>7.4.4.1 Rotary selector switches</b>	<b>7-65</b>
<ul style="list-style-type: none"> <li> <ul style="list-style-type: none"> <li>□ 7.4.4.1.1 Rotary selector switch specifications ..... 7-65</li> </ul> </li> </ul>	

	<b>Exhibit 7.4.4.1.1</b> Rotary selector switch specifications .....	7-66
□	7.4.4.1.2 When to use .....	7-65
□	7.4.4.1.3 Moving pointer, fixed scale .....	7-65
■	7.4.4.1.4 Shape .....	7-65
■	7.4.4.1.5 Number of positions .....	7-66
■	7.4.4.1.6 Placement of switch positions .....	7-66
■	7.4.4.1.7 Switch resistance .....	7-67
■	7.4.4.1.8 Reference line .....	7-67
■	7.4.4.1.9 Parallax .....	7-67
<b>7.4.4.2</b>	<b>Key-operated switches</b> .....	<b>7-67</b>
■	7.4.4.2.1 Key-operated switch specifications .....	7-67
	<b>Exhibit 7.4.4.2.1</b> Key-operated switch specifications .....	7-67
■	7.4.4.2.2 Color, shape, and size coding .....	7-67
■	7.4.4.2.3 Marking and labeling .....	7-68
■	7.4.4.2.4 Teeth on both edges .....	7-68
■	7.4.4.2.5 Teeth on a single edge .....	7-68
■	7.4.4.2.6 ON-OFF switches .....	7-68
□	7.4.4.2.7 Direction of rotation .....	7-68
□	7.4.4.2.8 Key removal .....	7-68
<b>7.4.4.3</b>	<b>Discrete thumbwheel controls</b> .....	<b>7-68</b>
□	7.4.4.3.1 When to use .....	7-68
■	7.4.4.3.2 Shape .....	7-68
□	7.4.4.3.3 Coding .....	7-68
■	7.4.4.3.4 Direction of movement .....	7-69
■	7.4.4.3.5 Internal illuminance and appearance of characters .....	7-69
□	7.4.4.3.6 External illuminance and appearance of characters .....	7-69
■	7.4.4.3.7 Visibility .....	7-69
■	7.4.4.3.8 Dimensions .....	7-69
	<b>Exhibit 7.4.4.3.8</b> Discrete thumbwheel specifications .....	7-69
■	7.4.4.3.9 Resistance .....	7-70
■	7.4.4.3.10 Separation .....	7-70
<b>7.4.4.4</b>	<b>Knobs</b> .....	<b>7-70</b>
■	7.4.4.4.1 Knob specifications .....	7-70
	<b>Exhibit 7.4.4.4.1</b> Knob specifications .....	7-71
□	7.4.4.4.2 When to use .....	7-70
□	7.4.4.4.3 Knob style .....	7-72



<b>7.4.4.5 Ganged control knobs</b>	.....	<b>7-72</b>
■ 7.4.4.5.1 Ganged control knob specifications	.....	7-72
<b>Exhibit 7.4.4.5.1</b> Ganged control knob specifications	.....	7-72
□ 7.4.4.5.2 When to use	.....	7-72
□ 7.4.4.5.3 Serrations	.....	7-73
■ 7.4.4.5.4 Marking	.....	7-73
■ 7.4.4.5.5 Knob and display relationship	.....	7-73
<b>Exhibit 7.4.4.5.5</b> Relationship between ganged knobs and their associated displays	.....	7-73
■ 7.4.4.5.6 Inadvertent movement, critical	.....	7-73
□ 7.4.4.5.7 Inadvertent movement, noncritical	.....	7-73
<b>7.4.4.6 Continuous adjustment thumbwheels</b>	.....	<b>7-74</b>
■ 7.4.4.6.1 Continuous thumbwheel specifications	.....	7-74
<b>Exhibit 7.4.4.6.1</b> Continuous thumbwheel specifications	.....	7-74
□ 7.4.4.6.2 When to use	.....	7-75
■ 7.4.4.6.3 Orientation and movement	.....	7-75
■ 7.4.4.6.4 Turning aids	.....	7-75
■ 7.4.4.6.5 OFF position	.....	7-75
<b>7.4.4.7 Cranks</b>	.....	<b>7-75</b>
■ 7.4.4.7.1 Crank specifications	.....	7-75
<b>Exhibit 7.4.4.7.1</b> Crank specifications	.....	7-76
□ 7.4.4.7.2 When to use	.....	7-75
■ 7.4.4.7.3 Grip handle	.....	7-75
□ 7.4.4.7.4 Folding handles	.....	7-75
■ 7.4.4.7.5 Crank balance	.....	7-75
<b>7.4.4.8 Push buttons</b>	.....	<b>7-77</b>
■ 7.4.4.8.1 Push button specifications	.....	7-77
<b>Exhibit 7.4.4.8.1</b> Push button specifications	.....	7-77
□ 7.4.4.8.2 When to use	.....	7-78
■ 7.4.4.8.3 When not to use	.....	7-78
□ 7.4.4.8.4 Shape	.....	7-78
■ 7.4.4.8.5 Positive feedback	.....	7-78
■ 7.4.4.8.6 Prevention of inadvertent operation	.....	7-78

<b>7.4.4.9 Keyboards</b>	.....	<b>7-78</b>
□ 7.4.4.9.1 When to use	.....	7-78
■ 7.4.4.9.2 Numeric keyboards	.....	7-78
■ 7.4.4.9.3 Alphanumeric keyboards	.....	7-78
■ 7.4.4.9.4 Two-dimensional cursor control	.....	7-78
□ 7.4.4.9.5 Cursor control key layout	.....	7-78
■ 7.4.4.9.6 Consistent keyboards	.....	7-78
■ 7.4.4.9.7 Positive feedback	.....	7-79
<b>7.4.4.10 Toggle switches</b>	.....	<b>7-79</b>
■ 7.4.4.10.1 Toggle switch specifications	.....	7-79
<b>Exhibit 7.4.4.10.1</b> Toggle switch specifications	.....	7-80
□ 7.4.4.10.2 When to use	.....	7-79
■ 7.4.4.10.3 Three-position toggle switches	.....	7-79
■ 7.4.4.10.4 Preventing accidental actuation	.....	7-79
■ 7.4.4.10.5 Positive feedback	.....	7-79
□ 7.4.4.10.6 Orientation	.....	7-79
<b>7.4.4.11 Legend switches</b>	.....	<b>7-81</b>
■ 7.4.4.11.1 Legend switch specifications	.....	7-81
<b>Exhibit 7.4.4.11.1</b> Legend switch specifications	.....	7-81
■ 7.4.4.11.2 Barriers	.....	7-81
■ 7.4.4.11.3 Positive feedback	.....	7-81
■ 7.4.4.11.4 Legibility of legend	.....	7-82
■ 7.4.4.11.5 Lamp replacement	.....	7-82
□ 7.4.4.11.6 Cover replacement	.....	7-82
■ 7.4.4.11.7 Legends	.....	7-82
<b>7.4.4.12 Rocker switches</b>	.....	<b>7-82</b>
■ 7.4.4.12.1 Rocker switch specifications	.....	7-82
<b>Exhibit 7.4.4.12.1</b> Rocker switch specifications	.....	7-83
□ 7.4.4.12.2 When to use	.....	7-82
■ 7.4.4.12.3 Three-position rocker switches	.....	7-82
■ 7.4.4.12.4 Preventing accidental actuation	.....	7-82
■ 7.4.4.12.5 Positive feedback	.....	7-82
■ 7.4.4.12.6 Orientation	.....	7-82
□ 7.4.4.12.7 Illumination	.....	7-83
■ 7.4.4.12.8 Labels	.....	7-84
<b>7.4.4.13 Slide switches</b>	.....	<b>7-84</b>
■ 7.4.4.13.1 Slide switch specifications	.....	7-84

	<b>Exhibit 7.4.4.13.1</b> Slide switch specifications .....	7-84
	■ 7.4.4.13.2 Preventing accidental actuation .....	7-85
	■ 7.4.4.13.3 Orientation .....	7-85
	■ 7.4.4.13.4 Positive feedback .....	7-85
<b>7.4.4.14 Discrete push-pull controls</b>	.....	<b>7-85</b>
	■ 7.4.4.14.1 Push-pull control specifications .....	7-85
	<b>Exhibit 7.4.4.14.1</b> Push-pull control specifications .....	7-86
	□ 7.4.4.14.2 When to use .....	7-85
	■ 7.4.4.14.3 Rotation .....	7-85
	■ 7.4.4.14.4 Detents .....	7-85
	■ 7.4.4.14.5 Snagging and inadvertent operation .....	7-86
	■ 7.4.4.14.6 Direction of movement .....	7-87
	□ 7.4.4.14.7 Resistance .....	7-87
<b>7.4.4.15 Printed circuit switches</b>	.....	<b>7-87</b>
	■ 7.4.4.15.1 Dimensions .....	7-87
	■ 7.4.4.15.2 Resistance .....	7-87
	■ 7.4.4.15.3 Displacement .....	7-87
	■ 7.4.4.15.4 Separation .....	7-87
	■ 7.4.4.15.5 Shape .....	7-87
<b>7.4.4.16 Levers</b>	.....	<b>7-87</b>
	■ 7.4.4.16.1 Lever specifications .....	7-87
	<b>Exhibit 7.4.4.16.1</b> Lever specifications .....	7-88
	□ 7.4.4.16.2 When to use .....	7-89
	■ 7.4.4.16.3 Coding .....	7-89
	■ 7.4.4.16.4 Labeling .....	7-89
	■ 7.4.4.16.5 Limb support .....	7-89
<b>7.4.4.17 Hand-operated displacement joysticks</b>	.....	<b>7-89</b>
	■ 7.4.4.17.1 Specifications .....	7-89
	■ 7.4.4.17.2 Movement characteristics .....	7-90
	□ 7.4.4.17.3 When to use .....	7-90
	■ 7.4.4.17.4 When not to use .....	7-90
<b>7.4.4.18 Finger-operated displacement joysticks</b>	.....	<b>7-90</b>
	■ 7.4.4.18.1 Finger-operated displacement joystick specifications .....	7-90

	<b>Exhibit 7.4.4.18.1</b> Finger-operated displacement joystick specifications .....	7-91
	▪ 7.4.4.18.2 Mounting .....	7-90
	▪ 7.4.4.18.3 Movement characteristics .....	7-90
<b>7.4.4.19 Thumbtip and fingertip-operated displacement joysticks</b>	.....	<b>7-91</b>
	▪ 7.4.4.19.1 Usage .....	7-91
	▪ 7.4.4.19.2 Mounting .....	7-92
	▪ 7.4.4.19.3 Movement characteristics .....	7-92
<b>7.4.4.20 Hand-operated isometric joysticks</b>	.....	<b>7-92</b>
	▪ 7.4.4.20.1 Specifications .....	7-92
	▪ 7.4.4.20.2 Mounting .....	7-92
<b>7.4.4.21 Thumbtip and fingertip-operated isometric joysticks</b>	.....	<b>7-92</b>
	▪ 7.4.4.21.1 Mounting .....	7-92
<b>7.4.4.22 Ball controls</b>	.....	<b>7-93</b>
	▪ 7.4.4.22.1 Specifications .....	7-93
	<b>Exhibit 7.4.4.22.1</b> Ball control specifications .....	7-93
	▪ 7.4.4.22.2 Limb support .....	7-93
	▪ 7.4.4.22.3 Movement characteristics .....	7-93
	□ 7.4.4.22.4 When to use .....	7-94
	▪ 7.4.4.22.5 Movement of a follower off a display .....	7-94
<b>7.4.4.23 Grid and stylus devices</b>	.....	<b>7-94</b>
	▪ 7.4.4.23.1 Specifications .....	7-94
	▪ 7.4.4.23.2 Dynamic characteristics .....	7-94
	□ 7.4.4.23.3 When to use .....	7-94
<b>7.4.4.24 Hand controls requiring high force</b>	.....	<b>7-94</b>
	▪ 7.4.4.24.1 Specifications .....	7-94
	<b>Exhibit 7.4.4.24.1</b> High-force hand control specifications .....	7-95
	▪ 7.4.4.24.2 When not to use .....	7-96

<b>7.4.4.25 Miniature controls</b>	.....	<b>7-96</b>
■ 7.4.4.25.1 Dimensions and separation	.....	7-96
□ 7.4.4.25.2 Resistance and displacement	.....	7-96
■ 7.4.4.25.3 When to use	.....	7-96
■ 7.4.4.25.4 Other requirements	.....	7-96
<b>7.5 Labeling and marking</b>	.....	<b>7-96</b>
<b>7.5.1 General</b>	.....	<b>7-96</b>
■ 7.5.1.1 Use	.....	7-96
■ 7.5.1.2 Size graduation	.....	7-96
□ 7.5.1.3 Demarcation with size graduation	.....	7-97
■ 7.5.1.4 General requirements	.....	7-97
■ 7.5.1.5 Principles of labeling	.....	7-97
■ 7.5.1.6 Avoid similar labels	.....	7-97
■ 7.5.1.7 Meaningful labels	.....	7-97
■ 7.5.1.8 Function labels	.....	7-97
■ 7.5.1.9 Functional relationship	.....	7-97
■ 7.5.1.10 Label mounting	.....	7-97
□ 7.5.1.11 Label removal	.....	7-97
■ 7.5.1.12 Curved labels	.....	7-97
■ 7.5.1.13 Label reflectance	.....	7-98
■ 7.5.1.14 Units of measurement	.....	7-98
□ 7.5.1.15 Tag mounting	.....	7-98
<b>7.5.2 Location and orientation</b>	.....	<b>7-98</b>
■ 7.5.2.1 Readability	.....	7-98
■ 7.5.2.2 No obstruction	.....	7-98
■ 7.5.2.3 Position near control or display	.....	7-98
□ 7.5.2.4 Above control or display	.....	7-98
□ 7.5.2.5 Separate labels	.....	7-98
■ 7.5.2.6 Functional grouping	.....	7-98
□ 7.5.2.7 Consistent location	.....	7-98
□ 7.5.2.8 Hierarchical labeling	.....	7-98
■ 7.5.2.9 Horizontal orientation	.....	7-99
■ 7.5.2.10 Preserving readability	.....	7-99
<b>7.5.3 Typographic matters</b>	.....	<b>7-99</b>
■ 7.5.3.1 Character height for viewing distance	.....	7-99
<b>Exhibit 7.5.3.1</b> Minimum character height for various viewing distances under normal luminance levels	.....	7-99
■ 7.5.3.2 Stroke width in normal illumination	.....	7-99

■ 7.5.3.3	Stroke width in dim illumination .....	7-99
■ 7.5.3.4	Stroke width for transilluminated characters .....	7-99
■ 7.5.3.5	Width to height ratios .....	7-99
■ 7.5.3.6	Character spacing .....	7-100
■ 7.5.3.7	Word spacing .....	7-100
■ 7.5.3.8	Line spacing .....	7-100
■ 7.5.3.9	Case of letters .....	7-100
<b>7.5.4</b>	<b>Design of label characters .....</b>	<b>7-100</b>
■ 7.5.4.1	Contrast .....	7-100
■ 7.5.4.2	Dark adaptation .....	7-100
□ 7.5.4.3	Style or font .....	7-100
□ 7.5.4.4	Confusion between characters .....	7-100
□ 7.5.4.5	Borders .....	7-101
<b>7.5.5</b>	<b>Wording and information .....</b>	<b>7-101</b>
□ 7.5.5.1	Wording .....	7-101
■ 7.5.5.2	Simplicity .....	7-101
■ 7.5.5.3	Consistency .....	7-101
■ 7.5.5.4	Irrelevant information .....	7-101
□ 7.5.5.5	Relevant information .....	7-101
■ 7.5.5.6	Pictorial symbols .....	7-101
<b>7.6</b>	<b>Accommodating people with disabilities .....</b>	<b>7-101</b>
<b>7.6.1</b>	<b>Physical manipulations for people with disabilities .....</b>	<b>7-103</b>
□ 7.6.1.1	Inserting and removing objects .....	7-103
□ 7.6.1.2	Opening doors and drawers .....	7-104
□ 7.6.1.3	Moving, removing, and replacing parts .....	7-104
□ 7.6.1.4	Understanding manipulations .....	7-105
<b>7.6.2</b>	<b>Displays for people with disabilities .....</b>	<b>7-105</b>
□ 7.6.2.1	Hearing auditory outputs .....	7-105
□ 7.6.2.2	Ensuring that auditory outputs are not missed .....	7-106
□ 7.6.2.3	Location of visual outputs .....	7-106
□ 7.6.2.4	Reaching printed outputs .....	7-107
□ 7.6.2.5	Perceiving visual displays .....	7-107
□ 7.6.2.6	Ensuring that visual outputs are not missed .....	7-107

	□ 7.6.2.7 Understanding visual and auditory outputs .....	7-108
	□ 7.6.2.8 Avoiding flashing-induced seizures .....	7-109
<b>7.6.3 Controls for people with disabilities</b>	.....	<b>7-109</b>
	□ 7.6.3.1 Manipulating controls .....	7-109
	■ 7.6.3.2 Maximum force requirements .....	7-110
	□ 7.6.3.3 Minimize force requirements .....	7-110
	□ 7.6.3.4 Unobstructed access .....	7-110
	□ 7.6.3.5 Momentary, not continuous, operation .....	7-110
	□ 7.6.3.6 One manipulation at a time .....	7-111
	□ 7.6.3.7 Unconstrained manipulation .....	7-111
	□ 7.6.3.8 Connecting special alternative input and control devices .....	7-111
	□ 7.6.3.9 Reaching controls .....	7-111
	□ 7.6.3.10 Finding controls .....	7-112
	□ 7.6.3.11 Reading control labels .....	7-112
	□ 7.6.3.12 Understanding control operation .....	7-113
	□ 7.6.3.13 Determining control status .....	7-113
<b>7.6.4 Telecommunications for people with disabilities</b>	.....	<b>7-114</b>
	■ 7.6.4.1 Telecommunications capabilities for people with hearing disabilities .....	7-114
<b>7.6.5 Safety for people with disabilities</b>	.....	<b>7-114</b>
	□ 7.6.5.1 Avoiding injury .....	7-114
	□ 7.6.5.2 Determining control status .....	7-114





## 7 Human-equipment interfaces

This section contains human factors engineering criteria and guidelines for the design and selection of displays and controls that are part of the human-equipment interfaces in FAA systems. Both general and specific design criteria and guidelines are provided for display-control integration, visual displays, aural displays, various types of controls, and labeling.

### 7.1 Display-control integration

This section contains design criteria and guidelines addressing the relationships, groupings, and movement of displays associated with controls.

#### 7.1.1 Basic display-control relationships

- **7.1.1.1 Relationship.** The relationship of a control to its associated display and a display to its associated control shall be immediately apparent and unambiguous to the maintainer.

**Discussion.** Display-control relationships can be made apparent through the use of one or more of the following: proximity, grouping, coding, demarcation, labeling, spacing, color coding, insert panels, and panel relief.

- **7.1.1.2 No obstruction.** The control itself should not obscure the display. Similarly, the maintainer's hand should not obscure the display while he or she is operating the control.

**Discussion.** Frequently, controls are located below displays so that both right- and left-handed people are accommodated.

- **7.1.1.3 Complexity and precision.** The complexity and precision of displays shall not exceed the ability of the maintainer to discriminate detail. Similarly, the complexity and precision of controls shall not exceed the maintainer's manipulative capability, including manual dexterity, coordination, and reaction time, under the dynamic conditions and environment in which his or her performance is expected to occur.
- **7.1.1.4 Feedback.** A display associated with an input control device shall provide feedback for any operation of the control. In general, this feedback shall occur so rapidly that the maintainer perceives it to be instantaneous (see also paragraph 7.1.3.2).
- **7.1.1.5 Time lag.** There should be no discernable time lag between a change in a system condition being monitored and its indication on a display. If there is a time lag between control activation and ultimate system state, the system should provide immediate feedback to the maintainer of the process and direction of parameter change.

- **7.1.1.6 Illumination.** Adjustable illumination shall be provided for all visual displays and for any labels or markings for displays, controls, and panels that must be read at night or under darkened conditions.
- **7.1.1.7 Simultaneous access.** If more than one maintainer requires simultaneous access to the same controls and displays, each maintainer shall have the physical and visual access to the controls and displays necessary to perform his or her tasks.
- **7.1.1.8 Emergency controls and displays.** Emergency controls and displays shall be located where they can be seen and reached quickly and easily.

## 7.1.2 Grouping of displays and controls

- **7.1.2.1 Functional grouping.** If functional grouping is used, related controls and displays shall be located near one another and arranged in functional groups, for example, power, status, and test.
- **7.1.2.2 Location based on order of use.** The controls and displays within a functional group shall be located to provide for left-to-right or top-to-bottom order of use, or both.
- **7.1.2.3 Arrangement of groups.** Provided that the integrity of grouping by function and sequence is not compromised, the more frequently used and the most important groups should be located in areas of easiest access.

**Example.** If two groups of controls are located on a panel (both of which are arranged by function and sequence), the most frequently used and most important of the two groups is to be placed within the easiest access.

- **7.1.2.4 Marking functional groups.** A functional group of controls and displays should be indicated by a technique such as enclosing the group with a line marked on the panel or color coding the group.
- **7.1.2.5 Consistency.** Provided that the integrity of grouping by function and sequence is not compromised, the location of recurring functional groups and individual items on different panels shall be consistent from panel to panel. Additionally, the arrangement of functionally similar controls and displays shall be similar when used in different locations on the same panel. Mirror image arrangements shall not be used.
- **7.1.2.6 Location and arrangement.** If a maintainer uses large numbers of controls and displays, their location and arrangement shall aid him or her in determining which control is used with which display, which control affects which equipment component, and which display describes which component.

- **7.1.2.7 Arrangement within groups.** Controls and displays within functional groups shall be arranged to correspond to operational sequence, function, or both.
- **7.1.2.8 Logical flow arrangement.** If there is no unique operational sequence, the controls and displays within a functional group should be arranged in a manner consistent with their logical flow.
- **7.1.2.9 Arrangement by importance or frequency of use.** If the controls and displays within a functional group are not used in any specific sequence, they should be arranged either in accordance with their importance or their frequency of use.
- **7.1.2.10 Different arrangement of controls and displays.** If controls are arranged in fewer rows than displays, controls affecting the top row of displays shall be positioned at the far left; controls affecting the second row of displays shall be placed immediately to the right of these, and so on.
- **7.1.2.11 Vertical and horizontal arrays.** If a horizontal row of displays is associated with a vertical column of controls or vice versa, the farthest left item in the horizontal array shall correspond to the top item in the vertical array. However, this type of arrangement shall be avoided whenever possible.
- **7.1.2.12 Simultaneous use.** A visual display that is monitored concurrently with manipulation of a related control shall be located so that the maintainer does not have to observe the display from an extreme visual angle, thus avoiding the possible introduction of errors due to parallax.
- **7.1.2.13 Multiple displays.** If a maintainer needs to manipulate a control while observing more than one display, the control shall be placed as near as possible to all of the related displays, but not so that it obscures any of the displays or so that the maintainer obscures any of the displays as he or she manipulates the control.
- **7.1.2.14 Combined control.** If more than one display is affected by a combined control, such as ganged knobs, the displays shall be arranged from left to right with the combined control below the center of the displays (the relationship between ganged knobs and their associated displays is illustrated in exhibit 7.4.4.5.5). The combined control shall not obscure any of the displays, and the maintainer shall not obscure any of the displays as he or she manipulates the control.
- **7.1.2.15 Displays selected by switches.** If one of a group of displays is selected for viewing with a rotary selector switch, the displays shall be arranged so that their sequence corresponds to the switch positions. For example, the top or left-most display might correspond to switch position one; the next display down or to the right, to switch position two, and so on. If the switch includes an OFF position, the OFF position shall be to the left of the first active position (that is, it shall be the most counter-

clockwise position). If applicable, displays that are not selected shall read off-scale, not zero.

- **7.1.2.16 Separated controls and displays.** If controls are located on panels separate from their associated displays, the control and display panels should be adjacent to each other.

**Discussion.** The preferred arrangement is to place the display panel above the control panel.

- **7.1.2.17 Arrangement of separated controls and displays.** If controls and displays are located on separate panels, the arrangement of the controls shall correspond to the arrangement of the associated displays.
- **7.1.2.18 Correspondence of controls and displays with equipment.** If applicable, the arrangement of controls and displays shall correspond to the physical arrangement of their associated units or components of equipment.
- **7.1.2.19 Alternative techniques.** If none of the preceding criteria or guidelines for arranging controls and displays applies, some other technique, such as color coding, should be used to indicate the association of controls and displays.

### 7.1.3 Movement relationships

- **7.1.3.1 Display response to control.** The response of a display to movements of its associated control shall be consistent, predictable, and compatible with the maintainer's expectations.
- **7.1.3.2 Display response time.** The delay between the movement of a control and the response to that movement on the display shall be minimized. The delay shall be consistent with safe and efficient system operation.
- **7.1.3.3 Moving pointer, circular scale.** Clockwise movement of a rotary control or movement of a linear control forward, up or to the right shall produce a clockwise movement of circular scale pointers and an increase in the magnitude of the reading.
- **7.1.3.4 Moving pointer, linear scale.** Clockwise movement of a rotary control or movement of a linear control forward, up or to the right shall produce a movement up of a pointer on a vertical linear scale and to the right of a pointer on a horizontal scale; in both cases, the control movement shall result in an increase in the magnitude of the reading.
- **7.1.3.5 Digital displays and arrays of indicator lights.** Clockwise movement of a rotary control or movement of a linear control forward, up, or to the right should produce increasing values in digital displays and a bottom-to-top or left-to-right movement in an array of indicator lights.

- **7.1.3.6 Fixed pointer, moving scale.** A display with a fixed pointer and a moving scale shall be used only if an operation requires it and it has been approved by the acquisition program office (see paragraph 7.2.3.1.1).
- **7.1.3.7 Fixed pointer, moving circular scale.** Clockwise movement of a rotary control or movement of a linear control forward, up, or to the right shall produce a counterclockwise movement of the scale and an increase in the magnitude of the reading (see paragraph 7.1.3.6).
- **7.1.3.8 Fixed pointer, moving linear scale.** Clockwise movement of a rotary control or movement of a linear control forward, up, or to the right shall produce a movement of the scale down or to the left and an increase in the magnitude of the reading (see paragraph 7.1.3.6).
- **7.1.3.9 Direct linkage.** If there is a direct linkage between a control and a display, such as a radio frequency selector control and a station pointer display, the control and the indicator shall move in the same direction. If the display is a rotary device that moves through an arc of 180° or more, a rotary control shall be used. If the display is a rotary device that moves through an arc of less than 180°, a linear control shall be used.
- **7.1.3.10 Common plane.** Controls shall be selected so that the direction of movement of the control is consistent with the related movement of an associated display and with the movement of any associated equipment.
- **7.1.3.11 Movement direction.** If a rotary control and a linear display are in the same plane, the part of the control adjacent to the display shall move in the same direction as the moving part of the display.
- **7.1.3.12 Labeling.** If the control-display relationships specified in this section cannot be followed, controls shall be clearly labeled to indicate the direction of control movement required.

#### 7.1.4 Display to control movement ratio

- **7.1.4.1 Minimization of time.** Display to control ratios for continuous adjustment controls shall minimize the total time required to make the desired control movement (that is, coarse adjustment time plus fine adjustment time), consistent with display size, tolerance requirements, viewing distance, and time delays.
- **7.1.4.2 Range of display movement.** If a wide range of display element movement is required, a small movement of the control shall yield a large movement of the display element. If a small range of display element movement is required, a large

movement of the control shall result in a small movement of the display element, consistent with the final accuracy required.

- **7.1.4.3 Knob, coarse setting.** If a knob is provided for making coarse display element settings on linear scales, that is, settings with a tolerance between 0.4 and 2.5 mm (0.016 and 0.100 in), one complete revolution of the knob shall result in moving the display element approximately 150 mm (6 in).
- **7.1.4.4 Knob, fine setting.** If a knob is provided for making fine display element settings on linear scales, that is, settings with a tolerance between 0.2 and 0.4 mm (0.008 and 0.016 in), one complete revolution of the knob shall result in moving the display element approximately 25 to 50 mm (1 to 2 in).
- **7.1.4.5 Bracketing.** If a rotary control will be used for bracketing to locate a maximum or minimum rather than to achieve a specific setting, for example, as in tuning a transmitter, rotation of the control of not less than 10° and not more than 30° shall produce a clearly noticeable peak or dip in the display.
- **7.1.4.6 Lever, coarse setting.** If a lever is provided for coarse settings, that is, settings with a tolerance between 0.4 to 2.5 mm (0.016 to 0.100 in), three units of lever movement shall result in one unit of movement of the display element.
- **7.1.4.7 Lever, coarse two-dimensional setting.** If a lever is provided to make coarse settings in two dimensions, that is, settings with a tolerance of 2.5 mm (0.100 in), two and a half units of lever movement shall result in one unit of movement of the display element.
- **7.1.4.8 Counters.** If a counter is provided, one complete revolution of the control shall result in approximately 50 counts, for example, five revolutions of a ten-count drum.

## 7.2 Visual displays

Almost all of the maintainer's decisions and actions depend upon the information presented to him or her by means of displays. This section contains criteria and guidelines for visual displays.

### 7.2.1 Principles of display

#### 7.2.1.1 General

- **7.2.1.1.1 Clear indication of conditions.** Visual displays should provide the maintainer a clear indication of equipment or system conditions for operation and maintenance under any eventuality commensurate with the operational and maintenance philosophies of the system under design.
- **7.2.1.1.2 Legibility.** Displays shall be legible under all anticipated viewing conditions.

**Discussion.** Factors affecting the legibility of a display include the nature and characteristics of the display itself, ambient lighting, and viewing distance.

- **7.2.1.1.3 Alerting and warning displays.** Alerting and warning displays shall result in a greater probability of a maintainer's detecting the triggering condition than would be the case in their absence (same as paragraph 7.2.1.5.1).
- **7.2.1.1.4 Content.** The information displayed to a maintainer shall be sufficient to allow him or her to perform the intended task.
- **7.2.1.1.5 Precision.** Information shall be displayed only within the limits and precision required for specific maintainer actions or decisions.
- **7.2.1.1.6 Directly usable.** Information shall be presented in a directly usable form, that is, maintainers shall not have to transpose, compute, interpolate, or mentally translate the information displayed into other units.
- **7.2.1.1.7 Combined operator and maintainer information.** Information specific to operators and maintainers shall not be combined within a single display unless (1) the content and format of the information are well suited to combination and (2) the combination does not hinder the performance of either operators or maintainers (see also paragraph 6.11.4).
- **7.2.1.1.8 Unnecessary markings.** Trademarks, company names, and other markings not needed to identify a panel or aid in performing tasks shall not be displayed on a panel face.
- **7.2.1.1.9 Display duration.** Visual signals and other displayed information shall be of sufficient duration to permit reliable detection and use by the maintainer under the expected workload and environmental conditions.
- **7.2.1.1.10 Timeliness.** Displays that require refreshing of information, such as cathode ray tubes (CRTs), head-up displays, and collimated displays, shall be refreshed at a rate that ensures that the displayed information is sufficiently current to permit maintainers to perform their required tasks (see paragraph 7.2.4.1.1).
- **7.2.1.1.11 Advisory and alerting displays.** If appropriate, integrated displays, that is, displays that contain more than a single type or piece of information, shall be capable of advising or alerting the maintainer if one or more of the pieces of information becomes critical.

### 7.2.1.2 Display reliability and validity

This section contains general criteria and guidelines for display reliability and validity. Additional specific criteria and guidelines are included in later sections pertaining to specific types of visual displays.

- **7.2.1.2.1 Redundancy.** Redundancy in the display of information shall be avoided unless it is required for specified safety or task performance reasons.
- **7.2.1.2.2 Display failure.** Failure of a display or its circuit shall be immediately apparent to the maintainer.
- **7.2.1.2.3 Display circuit failure.** Failure of a display circuit shall not cause a failure in the equipment associated with the display.

### 7.2.1.3 Visual coding

This section contains general criteria and guidelines for visual coding. Additional specific criteria and guidelines are given in sections pertaining to specific types of displays.

- **7.2.1.3.1 Objectives.** Visual coding shall be used to facilitate:
  - a. discrimination among individual displays,
  - b. identification of functionally related displays,
  - c. indication of relationships among displays, and
  - d. identification of critical information within a display.
- **7.2.1.3.2 Visual coding methods.** Displays shall be coded by color, size, location, shape, or flash coding as applicable.
- **7.2.1.3.3 Consistency.** Visual coding shall be consistent within a system or unit of equipment and between similar units of equipment.

### 7.2.1.4 Analog and digital coding

- **7.2.1.4.1 Analog and digital coding.** Information should be coded in either digital or analog form.

**Discussion.** Displays such as meters, plotters, and bar charts on CRTs are examples of analog displays; digital counters and numbers presented on CRTs are examples of digital displays.

- **7.2.1.4.2 When to use digital displays.** Digital displays should be used if there is a need for quick, precise readings of quantitative values and trend information is not needed.
- **7.2.1.4.3 When not to use digital displays.** Digital displays shall not be used if (1) they are the only information displays and perception of a pattern of variation is important or (2) values change so slowly or rapidly that reading them is difficult.
- **7.2.1.4.4 When to use analog displays.** Analog displays should be used if (1) values need to be considered in relation to ranges or zones or (2) trend information is required.



### 7.2.1.5 Visual warning and signal devices

- **7.2.1.5.1 Alerting and warning displays.** Alerting and warning displays shall result in a greater probability of a maintainer's detecting the triggering condition than would be the case in their absence (same as paragraph 7.2.1.1.3).

**Discussion.** In some cases it may be desirable to alert the maintainer by providing an audible signal as well as a visual signal (see section 7.3).

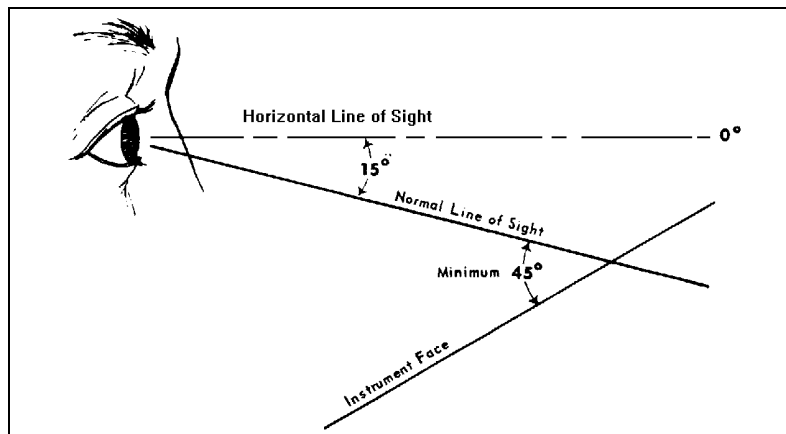
- **7.2.1.5.2 Alarm parameter selection.** If applicable, the limits or set points that initiate an alarm or warning display should be set so that the alarm gives maintainers adequate time to respond to the condition before it becomes more serious.
- **7.2.1.5.3 General alarms.** Alarms that require a maintainer to go to a different location for specific information should be avoided. If they are used, they should allow sufficient time for the maintainer to obtain and use the necessary information.
- **7.2.1.5.4 Prioritization of alarms.** If a system or unit of equipment permits several alarms to be visible or audible at the same time, the alarms shall be prioritized so that maintainers can differentiate the most important alarm or alarms from those that are less important. If two or more systems or equipment are in an alarm condition, then only the most important alarm shall be audible; less important alarms shall be suppressed.
- **7.2.1.5.5 Priority levels.** Prioritization of alarms shall be based on their importance, severity, and time urgency. The number of priority levels shall not exceed four.
- **7.2.1.5.6 Visual coding of priority levels.** Visual signals should be coded to indicate the priority level of the signal. Acceptable coding methods include color, position, shape, flashing, and symbol.
- **7.2.1.5.7 Audible coding of priority levels.** If audible signals accompany visual alarms, they, too, shall be coded by priority. Acceptable coding methods for audible signals include pulse coding, duration, and frequency. Intensity shall not be used as a coding method. If pulse coding is used, the number of levels shall not exceed three. If duration is used, the number of levels shall not exceed three. If frequency coding is used, the number of levels shall not exceed five.
- **7.2.1.5.8 Emergency conditions.** Flashing red shall be used to denote emergency conditions that require immediate maintainer action to avert impending injury, equipment damage, or both. The flashing rate shall be from three to five flashes per second, with approximately equal on and off times. If an emergency condition exists and the flasher fails, the light shall illuminate and burn steadily.

- **7.2.1.5.9 Visual tiles.** If visual tiles are used, their legends shall be in accordance with the criteria that follow.
  - a. Legends shall be concise, specific, and unambiguous.
  - b. Any abbreviations or acronyms used in legends shall be consistent with usage throughout the equipment or system.
  - c. Legends shall be legible in worst-case conditions, for example, from the far end of the room, or from a spot that maximizes glare.
- **7.2.1.5.10 Singular in purpose.** A visual alarm, with the exception of master caution, warning, and advisory indicators, shall be singular in purpose yet comprehensive in meaning. It shall not refer the maintainer to other alarm indicators for other warning information.
- **7.2.1.5.11 Automatic clearing of alarms.** The equipment or system that triggers an alarm shall clear the alarm automatically when the triggering condition no longer exists.
- **7.2.1.5.12 Out-of-service alarms.** If an alarm fails, the system shall provide a prompt indication of the failure.
- **7.2.1.5.13 Testing of alarms.** One or more controls shall be provided to permit the testing of alarms.

#### 7.2.1.6 Location and arrangement

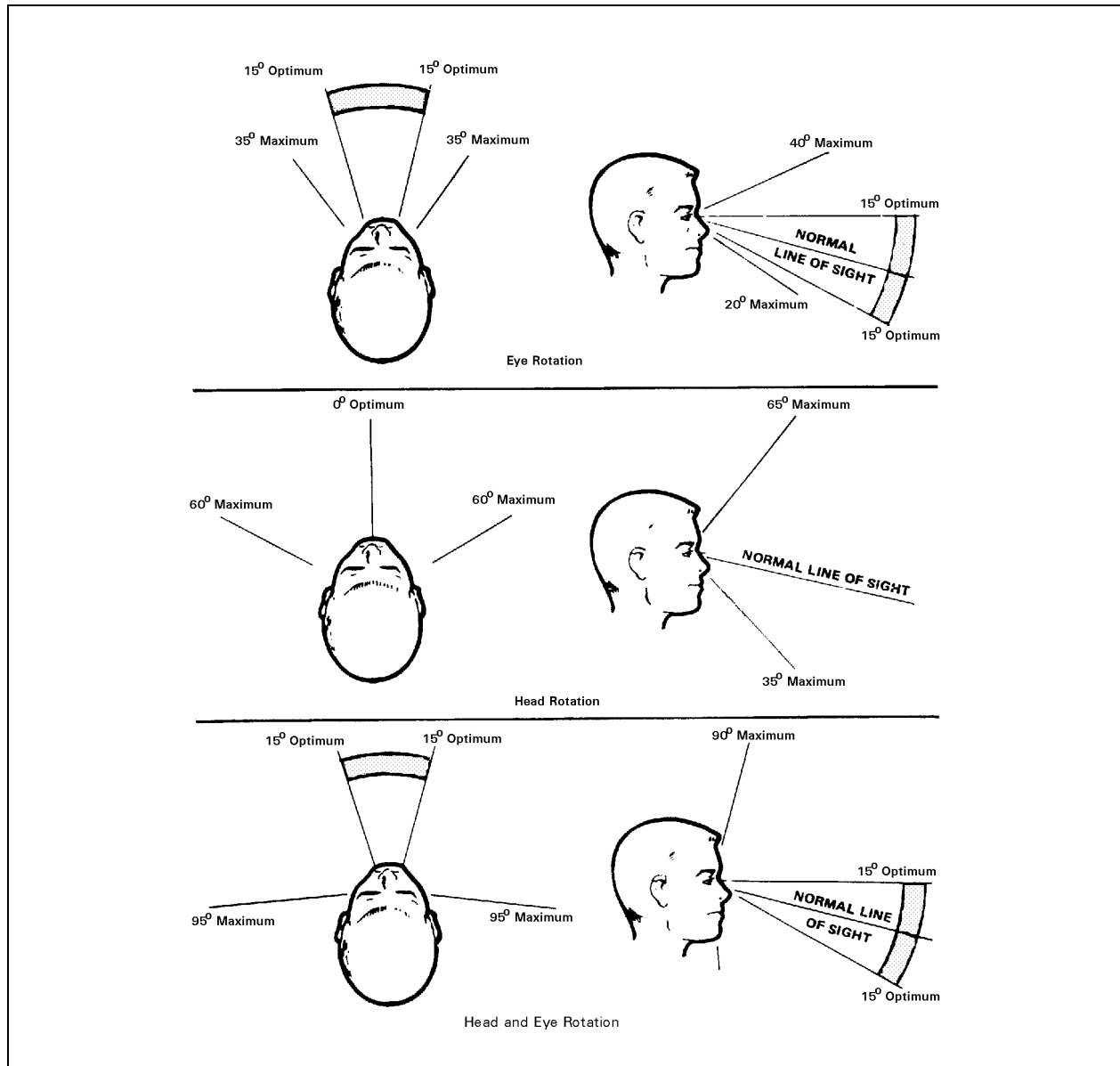
- **7.2.1.6.1 Location.** Displays shall be located so that a maintainer can read them to the degree of accuracy required without having to assume an uncomfortable, awkward, or unsafe position.
- **7.2.1.6.2 Accessibility.** A maintainer should be able to read a visual display without the use of a ladder, a flashlight, or other special equipment.
- **7.2.1.6.3 Orientation and parallax.** If feasible, display faces shall be perpendicular to the maintainer's line of sight. In no case shall they be more than 45° from the line of sight as illustrated in exhibit 7.2.1.6.3. Parallax shall be minimized.
- **7.2.1.6.4 Reflections.** Displays shall be constructed, arranged, and mounted to prevent interference from reflections of illumination sources, windows, and other visual displays. If necessary, shields, filters, or other techniques shall be used to ensure that system performance is not degraded.
- **7.2.1.6.5 Vibration.** Vibration of visual displays shall not hinder maintainers in the performance of their tasks.
- **7.2.1.6.6 Grouping.** All displays necessary to support a maintainer's activities or sequence of activities should be grouped together.

Exhibit 7.2.1.6.3 Lines of sight



- **7.2.1.6.7 Function and sequence.** Displays shall be arranged in relation to one another according to their sequence of use or the functional relations of the components they represent. If possible, they shall do both, that is, they shall be arranged sequentially within a functional group so that they provide a left-to-right or top-to-bottom information flow within the group.
- **7.2.1.6.8 Frequently used displays.** The displays used most frequently should be grouped together and placed in the optimum visual field, as illustrated in exhibit 7.2.1.6.8.
- **7.2.1.6.9 Important or critical displays.** Important or critical displays shall be located in the optimum visual field as illustrated in exhibit 7.2.1.6.8. Furthermore, they shall occupy a privileged position in that field, for example, the top or left-most position, or they shall be highlighted in some manner.
- **7.2.1.6.10 Consistency.** The arrangement of displays within a system shall be consistent in principle from application to application.
- **7.2.1.6.11 Maximum viewing distance.** If there is a control associated with a display, the viewing distance from the eye reference point of a seated maintainer to the associated display and control shall not exceed 635 mm (25 in).
- **7.2.1.6.12 Absolute minimum viewing distance.** With the exception of CRT displays (see paragraph 7.2.1.6.14) and collimated displays, the viewing distance from the eye reference point to a display shall not be less than 330 mm (13 in).
- **7.2.1.6.13 Preferred minimum viewing distance.** The viewing distance from the eye reference point to a display should be at least 510 mm (20 in).

Exhibit 7.2.1.6.8 Optimim vertical and horizontal visual fields



- **7.2.1.6.14 Minimum viewing distance to CRTs.** The minimum viewing distance from the eye reference point to a CRT should be at least 250 mm (10 in), although the design should allow viewers to move as close as they like.

## 7.2.2 Transilluminated displays

This section contains criteria and guidelines for transilluminated displays.

**Definition.** A **transilluminated display** is a display in which light passes through the element being viewed.

These displays include panels and indicators that use back- or edge-lighting and that use clear, translucent, fluorescent, or sandwich material.

Criteria and guidelines are given for three general types of transilluminated displays that are widely used: (1) legend lights that present information in the form of meaningful words, numbers, symbols, and abbreviations, (2) simple indicator lights, and (3) panel assemblies that present qualitative status or system readiness information.

### 7.2.2.1 General

- **7.2.2.1.1 When to use.** Transilluminated indicators should be used to display qualitative information that requires immediate attention or an immediate response. They may also be used occasionally, if appropriate, to display maintenance and adjustment information. Their use, however, should be minimized in general, reserved for displaying only that information necessary for effective operation and maintenance.
- **7.2.2.1.2 Meaning of illumination.** Illumination of a transilluminated display, including illuminated push buttons, shall indicate equipment response, not simply a response to the operation of a control.
- **7.2.2.1.3 Positive feedback.** Changes in display status shall signify changes in functional status, not simply a response to the operation of a control.
- **7.2.2.1.4 Meaning of no illumination.** The absence or removal of illumination of a transilluminated display shall not be used to indicate (1) a malfunction, "no-go," or out-of-tolerance condition or (2) a "ready" or in-tolerance condition unless the bulb can be easily tested by the operator. Similarly, the absence of illumination shall not indicate a "power off" condition on a maintenance display. The absence of illumination of a "power on" indicator is acceptable for an operational display.
- **7.2.2.1.5 Grouping of indicator lights.** Master caution lights, master warning lights, master advisory lights, and summation lights used to indicate the condition of an entire subsystem shall be set apart from lights that show the status of subsystem components, except as required in paragraph 7.2.2.1.8.
- **7.2.2.1.6 Location of transilluminated indicators.** If a transilluminated indicator is associated with a control, it shall be located so that the association of the indicator with the control is unambiguous and so that the light is visible as a maintainer is operating the control.
- **7.2.2.1.7 Location of indicators for critical functions.** Indicators for critical functions shall be located within 15° of the maintainer's normal line of sight, as illustrated in exhibit 7.2.1.6.8. The lever, switch, or other control device by which

the maintainer takes an action in response to the indicator shall be an integral part of or located as close as possible to the indicator.

- **7.2.2.1.8 Maintenance displays.** Indicator lights used solely for maintenance and adjustment shall be covered or nonvisible during normal operation of the equipment, but shall be readily accessible when needed.
- **7.2.2.1.9 Luminance.** The luminance of a transilluminated display shall be compatible with the expected ambient illuminance level, and shall be at least 10 percent greater than the surrounding luminance. If glare must be reduced, the luminance of the transilluminated display shall not exceed 300 percent of the surrounding luminance.
- **7.2.2.1.10 Variable luminance.** If a display will be used in varied ambient illuminance, a dimming control shall be provided. The range of control shall permit the display to be legible under the expected range of ambient illuminance. The control shall be capable of providing multiple steps or continuously variable illumination. Dimming to full OFF may be provided in noncritical operations, but shall not be used if inadvertent failure to turn an indicator ON could lead to a critical maintenance failure, such as the failure to detect or perform a critical step in a maintenance procedure.
- **7.2.2.1.11 False or obscured indication.** Indicators shall be arranged, mounted, or shielded to prevent direct or reflected light from making indicators appear to be illuminated when they are not or appear not to be illuminated when they are.
- **7.2.2.1.12 Contrast within an indicator.** The luminance contrast within an indicator shall be at least 0.1. Special displays specifically designed for legibility in sunlight are exempt from this criterion.

**Definition. Luminance contrast** is the contrast between a figure and its background. Luminance contrast ( $C$ ) is equal to the difference between the higher luminance value ( $L_1$ ) and the lower ( $L_2$ ) divided by the lower value ( $L_2$ ):  $C = (L_1 - L_2)/L_2$ .

- **7.2.2.1.13 Low ambient illumination.** If low ambient illumination is expected, the luminance contrast should be at least 9.0 with the background luminance less than the figure luminance.
- **7.2.2.1.14 Lamp redundancy.** Incandescent lamps used in displays shall be redundant, either through dual filaments or dual lamps. When one filament or lamp fails, the intensity of the display shall decrease sufficiently to indicate the need for lamp replacement, but not so much that the performance of a maintainer is degraded.
- **7.2.2.1.15 Lamp testing.** If a control panel includes indicator lights using incandescent lamps, it shall also include a means to

test the lamps (see paragraph 7.2.7.5, for exception). If maintenance procedures require dark adaptation, a means for reducing the total brightness of the indicators during testing shall be provided.

**Discussion.** If the panel contains three or fewer lamps, it is preferable that each lamp have its own "press-to-test" control. Otherwise, it is preferable that there be a single control that tests all lamps at the same time.

- **7.2.2.1.16 Indicator circuit testing.** A means should be provided for testing the operation of indicator circuits.
- **7.2.2.1.17 Removal and replacement of lamps.** Where possible, lamps shall be removable and replaceable through the front of the display panel. Removal and replacement of lamps shall not require the use of tools and shall be accomplished easily and rapidly.
- **7.2.2.1.18 Nonhazardous lamp replacement.** The removal and replacement of lamps while power is applied to the equipment shall not pose a hazard to the maintainer and shall not damage indicator circuit components.
- **7.2.2.1.19 Proper installation of indicator covers.** If the design of indicator covers does not prevent their inadvertent interchange, a means shall be provided for checking the covers after installation to ensure that they are properly installed.
- **7.2.2.1.20 Color coding.** Color coding of transilluminated displays shall be in accordance with exhibit 7.2.2.1.20.
- **7.2.2.1.21 Flashing lights.** The use of flashing lights shall be minimized. They shall be used only to call a maintainer's attention to a condition requiring immediate action. The flash rate shall be not less than three and not more than five flashes per second, with the on and off times being approximately equal. If more than one flashing indicator is located within a maintainer's field of view, their flashes shall be synchronized. If the indicator is activated but the flashing device has failed, the light shall remain ON.

### 7.2.2.2 Legend lights

- **7.2.2.2.1 When to use.** Legend lights shall be used in preference to simple indicator lights except where design considerations demand that simple indicators be used.
- **7.2.2.2.2 Color coding.** The color coding of legend lights shall conform to exhibit 7.2.2.1.20.
- **7.2.2.2.3 Size of legend lights.** Legend lights indicating existing or impending hazards (flashing red, red, and yellow) and master summation "go" (green) and "no-go" (red) shall be discriminably larger than other legend lights.

**Exhibit 7.2.2.1.20** Color coding of transilluminated displays

Color	Use	Examples
flashing red	to indicate an emergency condition that requires immediate action to avert impending injury, equipment damage, or both	
red	to indicate that (1) the system or a portion of the system is inoperative, or (2) successful task completion is not possible until appropriate corrective or override action is taken	"no-go" "error" "failure" "malfunction"
yellow	to indicate (1) a marginal condition, (2) an unexpected delay, (3) that caution is necessary, or (4) that rechecking is necessary	
green	to indicate that (1) equipment is "in tolerance," (2) conditions are satisfactory, or (3) it is all right to proceed	"go ahead" "in tolerance" "ready" "function activated"
white	to indicate system conditions that do not have "right" or "wrong" implications	(1) indicating which of several functions has been selected, (2) indicating a transitory condition such as an action or test in progress, provided such indications have no implications of success or failure
blue	to advise only	

- **7.2.2.2.4** Illuminated label versus illuminated background. An illuminated label and an opaque background shall be used: (1) if dark adaptation of the maintainer's eyes is required, (2) if the level of ambient illumination is high, or (3) if needed under other illumination conditions to distinguish control switches from display indicators with similar or identical labels. An opaque label on an illuminated background shall be used: (1) if the indicator is a critical alerting indicator, such as a master warning light, or (2) if dark adaptation is not required.
- **7.2.2.2.5 Lettering of legends.** The size and other characteristics of the lettering of legends on legend switches shall conform to section 7.5.5.
- **7.2.2.2.6 Visibility and legibility of legend.** In general, the lettering on single-legend indicators shall be visible and legible whether or not the indicator is illuminated. Warning and caution legends are excepted from this requirement.



**Discussion.** It is usually preferable that users not be able to read warning and caution legends when they are not illuminated.

- **7.2.2.2.7 Multi-legend indicators.** Indicators that are capable of presenting more than one legend shall present only one legend at a time, that is, only the legend in use shall be visible. If the indicator "stacks" the different legends, it shall be designed so that it meets the following criteria.
  - a. Legends higher in the stack do not obscure legends lower in the stack.
  - b. Parallax is minimized.
  - c. The brightness and contrast between the legend and background is approximately equal from one legend to another.

**7.2.2.3 Simple indicator lights**

- **7.2.2.3.1 When to use.** If design considerations preclude the use of legend lights, simple indicator lights should be used.
- **7.2.2.3.2 Spacing.** The spacing between adjacent edges of simple round indicator light fixtures shall permit unambiguous labeling, signal interpretation, and convenient lamp removal and replacement.
- **7.2.2.3.3 Coding.** The coding of simple indicator lights by size and color shall conform to exhibit 7.2.2.3.3.

**Discussion.** The different sizes shown in exhibit 7.2.2.3.3 are intended to vary the attention-demanding property of the lights. It is assumed that larger lights are at least equal in luminance to smaller ones.

**Exhibit 7.2.2.3.3** Coding of simple indicator lights

Size/type	Red	Color Yellow	Green	White
13 mm (0.5 in) diameter or smaller/ steady	Malfunction, action stopped, failure, stop	Delay, check, recheck, acceptable, action	Go ahead, in tolerance, ready	Functional or physical position, action in progress
25 mm (1 in) diameter or larger/ steady	Master summation (system or subsystem)	Extreme caution (impending danger)	Master summation (system or subsystem)	
25 mm (1 in) diameter or larger/ flashing (3 to 5 per sec)	Emergency condition (impending personnel or equipment disaster)			

#### 7.2.2.4 Transilluminated panel assemblies

- **7.2.2.4.1 When to use.** Transilluminated panel assemblies should be used to:
  - a. Provide illuminated labels for control panels,
  - b. serve as a light source for transilluminated control knobs,
  - c. provide illuminated association markings on a control panel, for example, connecting lines between controls, or outlines around a functionally-related group of controls, displays, or both, and
  - d. create a diagrammatic representation of such things as a system process or a communication network.
- **7.2.2.4.2 Large, single, pictorial graphic panels.** Large, single, pictorial graphic panels used to display system processing, communications networks, or other similar applications shall comply with the requirements for visibility, legibility, color, and illumination as specified in this standard.
- **7.2.2.4.3 Replacing lamps.** If replaceable incandescent lamps are used as the source of illumination for integral lighting of panel assemblies, the lamps shall be readily accessible without disconnecting the panel. A sufficient number of lamps shall be provided so that failure of one lamp will not cause any part of the display to be unreadable.
- **7.2.2.4.4 Brightness.** The brightness of illuminated markings and transilluminated controls shall be compatible with the ambient environment and operating conditions, for example, dark adaptation requirements. Brightness controls (dimming) shall be provided as necessary to maintain appropriate visibility and dark adaptation levels.

### 7.2.3 Scale indicators

#### 7.2.3.1 General

There are two general types of scale indicators, those in which the scale is fixed and the pointer moves, and those in which the pointer is fixed and the scale moves. In either case, the scales can be circular, curved (that is, an arc), straight and oriented vertically, or straight and oriented horizontally. Characteristics and ratings of the goodness of each type for a variety of uses are given in exhibit 7.2.3.1.

**Exhibit 7.2.3.1** Characteristics and ratings of fixed and moveable pointer scales for various uses

Use	Scales	
	Moving pointer	Fixed pointer
Quantitative information	<b>(Fair)</b> May be difficult to read while pointer is in motion.	<b>(Fair)</b> May be difficult to read while pointer is in motion.
Qualitative information	<b>(Good)</b> Location of pointer easy. Numbers and scale need not be read. Position change easily detected	<b>(Poor)</b> Difficult to judge direction and magnitude of deviation without reading numbers and scale
Setting	<b>(Good)</b> Simple and direct relation of motion of pointer to motion of setting knob. Position change aids monitoring	<b>(Fair)</b> Relation to motion of setting knob may be ambiguous. No pointer position change to aid monitoring. Not readable during rapid setting.
Tracking	<b>(Good)</b> Pointer position readily controlled and monitored. Simplest relation to manual control motion.	<b>(Fair)</b> No position changes to aid monitoring. Relation to control motion somewhat ambiguous.
General	Requires largest exposed and illuminated area on panel. Scale length limited unless multiple pointers are used.	Saves panel space. Only small section of scale need be exposed and illuminated. Use of tape allow long scale.

- **7.2.3.1.1 When to use.** Moving-pointer, fixed-scale indicators shall be used rather than fixed-pointer, moving-scale indicators. The latter shall be used only if an operation requires it and if it has been approved by the acquisition program office (see paragraph 7.1.3.6).
- **7.2.3.1.2 Type of information.** Scale indicators should be used (1) to display quantitative information in combination with qualitative information, for example, trend or direction-of-motion, and (2) if quantitative information is to be displayed and there is no need (such as speed or accuracy) for the use of printers or counters.
- **7.2.3.1.3 Linear scales.** Linear scales shall be used in preference to nonlinear scales unless system requirements clearly dictate nonlinearity to satisfy maintainer information requirements.
- **7.2.3.1.4 Scale graduations.** Scale graduations shall progress by 1, 2, or 5 units or decimal multiples thereof.
- **7.2.3.1.5 Intermediate marks.** The number of minor or intermediate marks between numbered scale marks shall not exceed nine.
- **7.2.3.1.6 Numerals.** Whole numbers shall be used for major graduation marks unless the measurement is normally expressed in decimals.

- **7.2.3.1.7 Scale starting point.** Display scales shall start at zero unless this is inappropriate for the information displayed.
- **7.2.3.1.8 Pointer length.** Control and display pointers should extend to, but not overlap, the shortest scale graduation marks.
- **7.2.3.1.9 Pointer tip.** Each side of the pointer tip should be tapered at a 20° angle (for a total included angle of 40°), terminating in a flat tip equal in width to the width of the minor scale graduations.
- **7.2.3.1.10 Pointer mounting.** The pointer shall be mounted as close as possible to the face of the dial to minimize parallax.
- **7.2.3.1.11 Pointer color.** Pointer color from the tip to the center of the dial shall be the same as the color of the marks. The tail of the pointer shall be the same color as the dial face, unless the tail is used as an indicator itself or unless the pointer is used for horizontal alignment.
- **7.2.3.1.12 Luminance contrast.** The luminance contrast between the scale face and the markings and between the scale face and the pointer shall be at least 3.0.
- **7.2.3.1.13 Calibration information.** Provisions shall be made for placing calibration information on instruments without degrading dial legibility.
- **7.2.3.1.14 Coding.** Coding, for example, by pattern or color, should be used on the face of scale indicators to convey such information as: (1) desirable, undesirable, and inefficient operating ranges; (2) dangerous operating levels; and (3) warnings and cautions.
- **7.2.3.1.15 Pattern or color coding.** If a given range on a scale indicates a desired operating or other condition, that range shall be made readily identifiable by means of pattern- or color-coding on the face of the indicator.
- **7.2.3.1.16 Use of colors.** Red, yellow, and green shall be used in accordance with the meanings specified in exhibit 7.2.2.1.20. If used, they shall be distinguishable under all expected lighting conditions.
- **7.2.3.1.17 Pattern coding.** If a scale having ranges will be viewed under low or colored illumination, the ranges should be coded by patterns rather than by color.

### 7.2.3.2 Moving-pointer, fixed-scale indicators

- **7.2.3.2.1 Numerical progression.** Numerical values shall increase on fixed scales in the clockwise direction, from left to

right, and from bottom to top, for curved, horizontal, and vertical scales, respectively.

- **7.2.3.2.2 Orientation.** Numbers on fixed scales shall be oriented in the upright position.
- **7.2.3.2.3 Scale reading and pointer movement.** The magnitude of a scale reading shall increase as the pointer moves clockwise, up, or to the right.
- **7.2.3.2.4 Zero position and direction of movement.** If positive and negative values are displayed in opposite directions from a zero or a null position, the magnitude of a positive scale reading shall increase as the pointer moves clockwise, up, or to the right, and the magnitude of a negative reading shall increase as the pointer moves counterclockwise, down, or to the left. If the indicator is circular, the zero or null point shall be located at either the 12 or 9 o'clock position.
- **7.2.3.2.5 Pointer alignment, circular scales.** If stable values exist for normal operating conditions in a group of circular-scale indicators, the indicators shall be arranged either in rows so that all pointers line up horizontally on the 9 o'clock position under normal operating conditions or in columns so that all pointers line up vertically on the 12 o'clock position under normal operating conditions. If the indicators are arranged in a matrix, the pointers shall be aligned on the 9 o'clock position rather than the 12 o'clock position.
- **7.2.3.2.6 Scale break.** Curved scales that do not indicate complete revolutions shall have a break between the two ends of the scale of at least 10°.
- **7.2.3.2.7 Number of pointers.** If precise readings are required, no more than two coaxial pointers shall be mounted on one indicator face.
- **7.2.3.2.8 Pointer alignment, noncircular scales.** If stable values exist for normal operating conditions in a group of indicators, vertical scales shall be arranged in rows so that the pointers are aligned horizontally, and horizontal scales shall be arranged in columns so that the pointers are aligned vertically.
- **7.2.3.2.9 Relative position of scale marks and numbers.** If reading time and accuracy are critical, circular scale markings and location of associated numbers shall be arranged to prevent pointers from covering any portion of the scale marks or numerals. Scale marks shall be on or close to the plane of the pointer tip to minimize parallax.

**Discussion.** If readout accuracy is not critical, that is, if the gross relationship between the pointer and a number is all that is required, the numbers may be placed inside the scale markings, where they are obscured by the pointer when it moves over them.

- **7.2.3.2.10 Placement of pointers.** Pointers shall be located to the right of vertical scales and at the bottom of horizontal scales.

- **7.2.3.2.11 Placement of numbers.** Numbers shall be placed on the side of graduation marks away from the pointer so that the pointer does not obscure the numbers.

**Discussion.** If the space for circular or curved scales is so limited that the graduations would be difficult to read with this placement, the numbers may be placed inside the graduation marks.

### 7.2.3.3 Fixed-pointer moving-scale indicators

- **7.2.3.3.1 When to use.** A fixed-pointer, moving-scale indicator shall be used only if an operation requires it and if it has been approved by the acquisition program office (see paragraph 7.1.3.6).
- **7.2.3.3.2 Numerical progression.** On fixed-pointer, moving-scale indicators, numbers shall increase in magnitude in the clockwise direction around the face of a circular or curved dial so that a counter-clockwise movement of the dial results in a higher reading. On vertical or horizontal straight moving scales, numbers shall increase from bottom to top or from left to right, respectively.
- **7.2.3.3.3 Orientation.** Numbers on moving scales shall be upright when in the reading position, that is, as they move past the pointer.
- **7.2.3.3.4 Alignment of pointer or fixed reference line.** For circular scales, the pointer or fixed reference line shall be aligned at the 12 o'clock position for right-left directional information and at the 9 o'clock position for up-down information. For purely quantitative information, either position may be used.
- **7.2.3.3.5 Setting.** If a display will be used for setting a value, for example, tuning a receiver to a specific frequency, the unused portion of the dial face shall be covered, and the open window shall be large enough to permit at least one numbered graduation to appear at each side of any setting.
- **7.2.3.3.6 Tracking.** If a display will be used for tracking, as in the case of a directional indicator, the whole face of the dial shall be exposed.
- **7.2.3.3.7 Moving tape displays.** If the length of a scale exceeds the limits of the display and if compression of the scale markings would make the display illegible or subject to errors in reading, a moving tape scale should be used.
- **7.2.3.3.8 Composite scalar and pictorial displays.** Functionally-related information from scales, pointers, and pictorialized symbols is sometimes combined to produce a single display, for example, an artificial horizon or a display that shows both true and relative bearings. The design of these composite displays shall conform to the criteria and guidelines of this

section for direction-of-motion, scale-pointer relationships, and legibility.

## 7.2.4 Cathode ray tube displays

### 7.2.4.1 General

- **7.2.4.1.1 Refresh rate.** Cathode ray tube (CRT) displays shall meet either of the following criteria: (1) the screen shall be refreshed at a rate of at least 50 Hz, or (2) the screen shall have no apparent flicker to at least 90 percent of a sample of the user population when viewed under the expected conditions of use.
- **7.2.4.1.2 Screen phosphor and persistence.** General purpose CRTs should use medium-persistence phosphors.

**Discussion.** High-persistence phosphors tend to produce trails or after images behind moving elements, and low-persistence phosphors are likely to result in a perceptible flicker.

- **7.2.4.1.3 Geometric distortion.** The combined effects of all geometric distortion should not displace any point on the projected display from its correct position by more than 2 to 5 percent of picture height.
- **7.2.4.1.4 Chromatic aberration.** Color fringes on images on CRT displays shall not have an adverse effect on a user's perception or performance. These fringes may be perceptible.
- **7.2.4.1.5 Luminance.** Either characters or their background, whichever has higher luminance, shall have a luminance of at least 35 cd/m<sup>2</sup> (10 fL).

### 7.2.4.2 Color

Some commonly used color combinations for monochrome monitors are black images on a white background, white images on a dark background, green images on a dark background, and amber images on a dark background.

- **7.2.4.2.1 Preferred colors.** If light images on a dark background will be viewed extensively, the images should be amber or green rather than white.
- **7.2.4.2.2 Color saturation.** If possible, highly saturated colors should be used to maximize differences among colors. If hue saturation combinations are used to provide different values for a color code, caution should be taken to ensure that changes in saturation do not produce colors difficult to see under some viewing conditions, such as high levels of ambient illumination.
- **7.2.4.2.3 Color coding.** Red, green, and yellow may be used to code alphanumeric information; blue should be used only to code large symbols and only if symbol identification is not a problem; and white should be used to code peripheral signals. Color codes

should conform to conventional meanings as listed in exhibit 7.2.2.3.3.

- **7.2.4.2.4 Limitations of color usage.** The following restrictions on the use of specific colors shall be incorporated into display design.
  - a. If orange is used, it shall be readily differentiated from red, yellow, and white.
  - b. Magenta shall be used sparingly.
  - c. Pure blue shall not be used on a dark background for text, thin lines, or high resolution information.
  - d. Simultaneous presentation of both pure red and pure blue (and to a lesser extent, red and green or blue and green) on a dark background shall be avoided since they may result in a three dimensional effect, unless this effect is intentional or acceptable.
  - e. Dominant wavelengths above 650 nm shall be avoided because people with protanopic vision are noticeably less sensitive to these wavelengths.
  - f. Once a color is assigned a specific use or meaning, no other color shall be used for the same purpose.

### 7.2.4.3 Ambient illumination

- **7.2.4.3.1 Screen luminance.** The ambient illuminance shall not contribute more than 25 percent of screen brightness through diffuse reflection and phosphor excitation. A control shall be provided to vary the CRT luminance from 10 percent of minimum ambient luminance to full CRT luminance. A control shall be provided to vary the luminous symbol and dark background or dark symbol and luminous background contrast ratio.
- **7.2.4.3.2 Faint signals.** If the detection of faint signals is required, and if the ambient illuminance may be above 2.7 lux (0.25 ft-c), CRTs shall be hooded, shielded, or recessed. A filter system shall not be used unless approved by the acquisition program office.
- **7.2.4.3.3 Luminance range of adjacent surfaces.** The luminance range of surfaces immediately adjacent to CRTs shall be between 10 and 100 percent of screen background luminance. With the exception of emergency indicators, no light source in the immediate surrounding area shall be of greater luminance than the CRT signal.
- **7.2.4.3.4 Ambient illuminance.** The ambient illuminance in the CRT area shall be appropriate for other visual functions such as setting controls, reading instruments, and maintenance, but shall



not degrade the visibility of signals on the CRT display. If a CRT display is used in variable ambient illuminance, illuminance controls shall be provided to dim all light sources, including illuminated panels, indicators, and switches in the immediate vicinity of the CRT. Automatic adjustment of CRT brightness may be used if the adjustment is a function of ambient illuminance and the range of adjustment is adequate for the full range of ambient illuminance.

- **7.2.4.3.5 Medium to high ambient illumination.** If the ambient illumination in the vicinity of the CRT is in the medium to high range, such as in normal office and control room illumination, dark characters and symbols on a light background should be used rather than light characters on a dark background (same as paragraph 7.2.4.6.4).

#### 7.2.4.4 Glare control

Glare may be of two types, diffuse or specular. Diffuse glare is caused by the general environmental illuminance, which effectively reduces the display contrast. Specular glare is the appearance of unwanted images (reflections) on the display surface. The most effective method of glare control is to design the workplace so that neither type is produced. Other methods include screen meshes placed over the display surface, etched faceplates, anti-reflective coatings, and bonded quarterwave filters. All of these degrade both contrast and resolution to some degree.

- **7.2.4.4.1 Glare.** Glare shall be minimized by (1) proper placement of the CRT relative to light sources, (2) use of an anti-glare treatment, such as a diffusing surface or an optical coating, or (3) filter control of the light sources. Hoods shall not be used for this purpose because they tend to restrict the viewing angle of screens. Use of anti-glare treatments shall not violate the requirements for luminance, contrast, and resolution contained in this section.
- **7.2.4.4.2 Adjacent surfaces.** Surfaces adjacent to the CRT shall have a dull, matte finish in accordance with FAA-STD-001B.
- **7.2.4.4.3 Avoiding reflected glare.** To the extent possible, glare should be avoided by altering the angular relationships among the user, the display, and the glare source. One way to do this is to give the user the ability to adjust the height, viewing angle, and contrast of the display.
- **7.2.4.4.4 Etched filters.** Etches with gloss values of 45 or less should not be used on monochrome CRTs, and etched filters should not be used on high-resolution displays.

#### 7.2.4.5 Viewing distance, angle, and screen orientation

- **7.2.4.5.1 Viewing distance.** If practical, a 400 to 700 mm (16 to 28 in) viewing distance shall be provided.

**Discussion.** If periods of viewing a CRT will be short, or if dim signals must be detected, the viewing distance may be reduced to 250 mm (10 in).

- **7.2.4.5.2 Variable viewing distance.** The workplace design should permit the observer to view the CRT from as close as desired.
- **7.2.4.5.3 Viewing angle and screen orientation.** The CRT screen should be directly in front of the viewer when the viewer is in his or her normal working position. The line of sight from the viewer's eyes to the center of the screen should be between 10° and 20° below horizontal. The screen should be tilted back so that the surface is perpendicular to the line of sight. The top of the screen should not be above the viewer's eye level.
- **7.2.4.5.4 Visual display terminals for office environments.** Visual display terminals for use in office environments shall conform to the criteria and guidelines in ANSI/HFS 100-1988.

#### 7.2.4.6 Alphanumeric character displays

- **7.2.4.6.1 Font legibility.** If alphanumeric characters appear on CRT-like displays, the font style shall allow discrimination of similar characters, for example the letter "l" and the number "1", or the letter "Z" and the number "2". Fonts with serifs, variable stroke widths, and slanting characters shall be avoided.
- **7.2.4.6.2 Character size (height).** The vertical viewing angle for alphanumeric characters shall be 16 min of arc for black and white displays and 21 min of arc for color displays. The preferred angles are 20 min and 30 min, respectively. Exhibit 7.2.4.6.2 gives minimum character heights as a fraction of the viewing distance for different types of information and two levels of display brightness. It includes actual values for a typical viewing distance of 457 mm (18 in).

**Exhibit 7.2.4.6.2** Minimum alphanumeric character height; as a fraction of viewing distance and, at a viewing distance of 457 mm (18 in)

Type of displayed information	High display brightness (1.0 fL or more)	Low display brightness (.03 to 1.0 fL)
Critical data, position on display variable	.0045 2 mm (.08 in)	.007 3.3 mm (.13 in)
Critical data, position fixed	.0035 1.5 mm (.06 in)	.0055 2.5 mm (.10 in)
Noncritical data (labels, etc.)	.002 1 mm (.04 in)	.002 1 mm (.04 in)

- **7.2.4.6.3 Luminance contrast.** Contrast between light characters and a dark screen background shall be at least 6:1, or 1:6 for dark characters on a light background. The preferred values are 10:1 and 1:10, respectively.
- **7.2.4.6.4 Medium to high ambient illumination.** If the ambient illumination in the vicinity of the CRT is in the medium to high range, such as in normal office and control room illumination, dark characters and symbols on a light background should be used rather than light characters on a dark background (same as paragraph 7.2.4.3.5).
- **7.2.4.6.5 Resolution.** CRTs for displaying simple alphanumeric text shall have a resolution of at least 0.8 resolution elements per mm (20 per in). Alphanumeric characters should have at least 10 resolution elements per character height. If high reading speed is required, high resolution monitors with at least 3.5 pixels per mm (90 pixels per in) shall be used.

#### 7.2.4.7 Symbolic and pictographic coding and displays

- **7.2.4.7.1 Pictorial and graphic situation formats.** Pictorial or situation data, such as plan position indicator data, shall be presented as luminous symbols on a dark background.
- **7.2.4.7.2 Signal size.** If a target of complex shape is to be distinguished from other objects having complex shapes, the target shape should subtend a visual angle of at least 20 min. An angle of 40 min is preferred. At a viewing distance of 18 in, these angles represent values of 1.5 mm (0.06 in) and 3.0 mm (0.12 in), respectively. The complex shape should span at least 10 lines or resolution elements. Image quality should be consistent with the maintainer's needs.
- **7.2.4.7.3 Resolution.** CRTs for displaying complex symbols and graphic detail should have at least 3.9 resolution elements per mm (100 per in).
- **7.2.4.7.4 Display updating.** Typical control room displays should be updated at least as frequently as once every 4 seconds. Updating may occur less frequently if consistent with the system and the information needs of the maintainer. However, if updating occurs less frequently than once every four seconds, the display should include information about the age of the displayed information.
- **7.2.4.7.5 Character height-to-width ratio.** The ratio of character height to width shall be:
  - a. 1:0.7 to 1:0.9 for equally-spaced characters and lines of 80 or fewer characters,
  - b. at least 1:0.5 if it is necessary to have more than 80 characters per line, or

- c. as much as 1:1 for characters such as M and W for proportionally-spaced characters (same as paragraph 8.2.3.8).
- **7.2.4.7.6 Stroke width.** Stroke width should be at least 1/12 of character height.
- **7.2.4.7.7 Spacing between characters.** Spacing between characters shall be at least 10 percent of character height (same as paragraph 8.2.3.3).
- **7.2.4.7.8 Spacing between words.** Spacing between words shall be at least one character width for equally-spaced characters or the width of capital N for proportionally-spaced characters (same as paragraph 8.2.3.4).
- **7.2.4.7.9 Spacing between lines.** Spacing between lines shall be at least two stroke widths or 15 percent of character height, whichever is greater. This space is in addition to any space required for accent marks on upper case characters and descenders on lower case letters (same as paragraph 8.2.3.5).

## 7.2.5 Large-screen displays

The selection or design of a large-screen display, especially a projection display, may be more complex than that of other workstation displays. The effects of ambient illumination, observer location, type of data to be displayed, visual acuity for symbol size and contrast, screen size, screen format, symbol luminance, and screen gain are all important factors.

### 7.2.5.1 General

Currently both direct view (such as, high luminance CRTs and large plasma displays) and projection (such as, light valves and projection CRTs) large-screen displays are in use. Criteria and guidelines for direct view large-screen displays are given in this section and those for large-screen projection displays are given in section 7.2.5.2.

- **7.2.5.1.1 When to use.** Large-screen displays should be used if:
  - a. More than one maintainer needs to refer to the same displayed information, but space or other constraints make the use of a single, common display preferable to many, individual displays.
  - b. One or more members of a team of maintainers need to be able to move about, yet still need access to displayed information.
- **7.2.5.1.2 When not to use.** Large-screen displays shall not be used if the spatial and environmental conditions do not allow all critical maintainers to have appropriate visual access in terms of viewing distance, angle, and lack of interference from intervening objects, personnel, and ambient lighting. (If the display is optically projected, see section 7.2.5.2.)
- **7.2.5.1.3 Viewing distance.** The display shall be near enough that the most distant viewers can resolve the critical details

presented, but not closer to any viewer than 1/2 the display width or height, whichever is greater.

- **7.2.5.1.4 Physical interruption of view.** A large-screen display shall be located so that its critical users do not have their view of it obscured by persons moving about in their normal traffic patterns.
- **7.2.5.1.5 Control of displayed information.** Control of large-screen group display systems shall ensure that critical information cannot be modified or deleted inadvertently or arbitrarily. Changes in the group display shall be under the control of designated maintainers who operate according to pre-established procedures, on command of a person in charge, or both. If a user must make changes that are of interest only to him or her, a separate, remote display shall be provided.
- **7.2.5.1.6 Content of displayed information.** The content of displayed information shall be evident to a trained user without requiring reference to display control settings. If their meaning is not obvious, display elements shall be labeled.
- **7.2.5.1.7 Minimum matrix.** If characters are formed from dot matrixes, the matrix shall be at least 10 by 14 dots.
- **7.2.5.1.8 Character size.** The height of letters and numerals shall be at least 10 min of visual angle. The preferred minimum visual angle is 15 min (same as paragraph 7.2.5.2.6 for large-screen projected displays).
- **7.2.5.1.9 Luminance.** Modulated output luminance, spatially averaged over the full screen, should be 300 to 400 lumens for small rooms and 750 to 2000 lumens for large rooms, assuming 215 to 430 lx (20 to 40 fc) ambient luminance in each case.
- **7.2.5.1.10 Character size and luminance.** Large characters (>20 min of arc) should have a contrast ratio of at least 1.5:1.
- **7.2.5.1.11 Character aspect ratio.** Character aspect ratio should be approximately 1.33:1.48 (width:height ratio).

**Definition.** **Aspect** is the ratio of the horizontal to vertical dimensions of a character or image.

- **7.2.5.1.12 Modulation depth.** A display should deliver at least 15% visual contrast when measured as modulation depth  $[(L_{\max} - L_{\min}) / L_{\max}]$ , when an alternating pixel pattern is displayed at normal luminance levels.
- **7.2.5.1.13 Polarity.** Text should be displayed as dark characters on a light background.
- **7.2.5.1.14 Background for colored objects.** If the display includes color-coded objects, the background should be a neutral color such as gray.

### 7.2.5.2 Large-screen optical projection displays

- **7.2.5.2.1 When to use.** If ambient light can be properly controlled, optical projection displays shall be used for applications requiring group presentation, pictorial and spatial information, past history versus real-time presentation, synthetically generated pictures, simulation of the external world, or superimposition of data from more than one source. Rear projection shall be used where physical obstructions to front projection result in poor visibility, or where work areas require high ambient illumination for other activities.
- **7.2.5.2.2 Viewing distance and screen size.** The ratio of viewing distance to screen size (measured diagonally) shall be not more than 8:1 and not less than 2:1.

**Discussion.** The optimum ratio is 4:1; the preferred range is not less than 3:1 or more than 6:1.

- **7.2.5.2.3 Viewing angle.** The angle off center line for viewing a large-screen display shall not be greater than 30° for groups or 10° for individuals.

**Discussion.** The optimum viewing angle is 0°; the preferred limit is 20°.

- **7.2.5.2.4 Image luminance and light distribution.** The image luminance with no film in the operating projector shall be not less than 17 cd/m<sup>2</sup> (5 fL), and not more than 70 cd/m<sup>2</sup> (20 fL). The ratio of maximum to minimum luminance across the screen shall be not greater than 3:1. The ratio of maximum to minimum luminance as a function of viewing location shall be not greater than 4:1. The ratio of ambient light to the brightest part of the image shall be not greater than 1:10 for black and white images and 2:10 for images with gray scale or color. The luminance of the screen center at the maximum viewing angle shall be at least half its maximum luminance.

**Discussion.** The optimum image luminance is 35 cd/m<sup>2</sup> (10 fL), and the preferred range is from 27 to 48 cd/m<sup>2</sup> (8 to 14 fL). The optimum ratio of maximum to minimum luminance across the screen is 1:1, and the preferred limit is 1.5:1. The optimum ratio of maximum to minimum luminance as a function of viewing location is 1:1, and the preferred limit is 2:1. The optimum ratio of ambient light to the brightest part of the image is 0:1, and the preferred range is 1:100 to 1:500.

- **7.2.5.2.5 Character style.** A simple type font shall be used. Stroke width shall be 1/6 to 1/8 of character height, but may be narrower for light markings on a dark background. Stroke width shall be the same for all letters and numerals of equal height. Letter and numeral widths, character spacing, word spacing, and

spacing between lines shall conform to paragraphs 7.2.4.7.5, 7.2.4.7.7, 7.2.4.7.8, and 7.2.4.7.9, respectively.

- **7.2.5.2.6 Character size.** The height of letters and numerals shall be at least 10 min of visual angle. The preferred minimum visual angle is 15 min (same as paragraph 7.2.5.1.8 for large-screen direct view displays)
- **7.2.5.2.7 Luminance ratio.** Under optimal ambient lighting conditions, the luminance ratio for optically projected displays should be 500:1.

**Definition. Luminance ratio** is the ratio of the luminance of an object to that of its surrounding field or background.

- **7.2.5.2.8 Minimum luminance ratio.** The minimum luminance ratio for viewing charts, printed text, and other line work shall be 5:1. For images that contain limited shadows and detail, for example, animation, or photographs with a limited luminance range, the minimum luminance ratio shall be 25:1. For images that contain a full range of colors, or grays in black-and-white photographs, the minimum luminance ratio shall be 100:1.
- **7.2.5.2.9 Superimposed images.** Contrast may be either light on dark background or vice-versa, except when images are superimposed. For subtractive superimposition (superimposed at the source), images shall be presented as dark markings on a transparent background. For additive superimposition (superimposed on the screen), images shall be light markings on an opaque background. Colored markings on colored backgrounds of comparable brightness shall be avoided.
- **7.2.5.2.10 Alignment.** Misregistration of superimposed alphanumeric data or other symbols shall be minimized.
- **7.2.5.2.11 Minimizing distortion.** Distortion of the projected image shall be minimized by ensuring that the screen is as nearly as possible perpendicular to the light beam from the projector.
- **7.2.5.2.12 Projection displays.** Projection equipment should be positioned so that the light source is not readily visible to viewers looking at the display.
- **7.2.5.2.13 Reflected luminance of screen.** The contrast ratio of the reflected luminance of the screen with a projected light source to the reflected luminance of the screen without a projected light source should be approximately 500:1.
- **7.2.5.2.14 Alternative projection methods.** If there is a need for increased contrast or to position personnel in the field of projection, an alternative to ordinary optical projection should be chosen, for example, rear projection.

## 7.2.6 Dot matrix and segmented displays

- **7.2.6.1 Seven-segment displays.** Seven-segment displays shall only be used to present numeric information.

**Discussion.** Dot matrix, 14-segment, and 16-segment displays may be used for applications involving interactive computer systems, instruments, avionics, navigation, and communication equipment, wherever the presentation of alphanumeric, vector-graphic, symbolic, or real-time information is required.

- **7.2.6.2 Matrix size.** The smallest matrix for defining a symbol shall be 5 by 7 dots. If system requirements call for symbol rotation, the minimum size shall be 8 by 11 dots.

**Discussion.** The preferred minimum size for a dot matrix is 7 by 9 for stationary symbols and 15 by 21 for rotating symbols.

- **7.2.6.3 Visual angle.** Alphanumeric characters and symbols formed from dot matrixes shall subtend a visual angle of at least 20 min.
- **7.2.6.4 Viewing angle.** Dot matrix and segmented displays should not be designed for viewing at an angle exceeding 35° from perpendicular to the display.
- **7.2.6.5 Emitter color.** Monochromatic displays shall use colors in the following order of preference: green (555 nm), yellow (575 nm), orange (585 nm), and red (660 nm). Blue emitters shall not be used.
- **7.2.6.6 Intensity control.** Dimming controls shall be provided if applicable to maintain appropriate legibility and a maintainer's dark adaptation level.

## 7.2.7 Light emitting diodes

- **7.2.7.1 General.** Light emitting diodes (LEDs) shall conform to the same criteria and guidelines as transilluminated displays (see section 7.2.2).
- **7.2.7.2 When to use.** LEDs should be used for transilluminated displays, including legend and simple indicator lights, and for matrix (alphanumeric) displays, only if the display is bright enough to be readable in the environment of intended use (see also paragraph 7.2.2.1.9).

**Note:** The display may be "washed out" at high levels of illumination.



- **7.2.7.3 Intensity control.** The dimming of LEDs should be proportionate with the dimming of incandescent lamps in the work place.
- **7.2.7.4 Color coding.** The color coding of LEDs other than red alphanumeric displays shall conform to the uses listed in exhibit 7.2.2.1.20. Red alphanumeric displays shall not be used near red lights that are used in the ways stated in the exhibit.
- **7.2.7.5 Testing.** LED indicator lights having a rating of 100,000 hours mean time between failures shall not require the lamp test capability specified in paragraph 7.2.2.1.15.
- **7.2.7.6 Location of red alphanumeric LEDs and segmented displays.** Red LED and segmented displays shall not be grouped with or located adjacent to red warning lights.

**7.2.8 Special displays**

This section contains criteria and guidelines for special displays. The displays covered are flat-panel, liquid crystal, gas plasma, electroluminescent, and stereoscopic displays. Cell failure within displays needs to be considered when selecting a particular type of display because cell failures often lead to performance problems.

**7.2.8.1 Flat-panel displays**

In flat-panel displays, images are formed from discrete, nonoverlapping, rectangular pixels. These images can differ from images on cathode ray tubes in character-to-character spacing, interline spacing, character and symbol design, the effect of ambient illumination, image polarity, and failure mode.

- **7.2.8.1.1 Character formation -- vertical orientation.** Characters in a vertical orientation should be formed from a matrix of at least 9 by 13 pixels.
- **7.2.8.1.2 Character formation -- nonvertical orientation.** Characters in a nonvertical orientation should be formed from a matrix of at least 8 by 11 pixels. The preferred size is 15 by 21 pixels.
- **7.2.8.1.3 Character stroke width.** Character stroke width should not exceed the minimum and maximum values given in exhibit 7.2.8.1.3.

**Exhibit 7.2.8.1.3** Stroke width for pixel-generated characters

Pixels in upper case character height	Minimum stroke pixel count	Maximum stroke pixel count
7 to 8	1	1
9 to 12	1	2
13 to 14	2	2
15 to 20	2	3
21 to 23	2	4

- **7.2.8.1.4 Character height-width relationship.** The width of characters of a given height should not exceed the minimum and maximum values given in exhibit 7.2.8.1.4. The exhibit also includes the preferred values.

**Exhibit 7.2.8.1.4** Height-width relationship for pixel-generated characters

Pixels in upper case character height	Minimum width pixel count	Preferred width pixel count	Maximum width pixel count
7	4	5	5
8	4	6	7
9	5	6	8
10	5	7	9
11	6	8	10
12	6	9	11
13	6	9	12
14	7	10	13
15 or 16	8	11	14

- **7.2.8.1.5 Image formation time.** If motion artifacts are not important, image formation time should not exceed 55 msec. If motion artifacts are important, image formation time should not exceed 10 msec.
- **7.2.8.1.6 Pixel failure rate.** Displays should be selected and maintained so that the pixel failure rate does not exceed 1%.
- **7.2.8.1.7 Text redundancy to counteract display element failure.** If display element failure is expected to be a problem, the redundancy in text should be increased to minimize the impact on reading performance due to the failures.
- **7.2.8.1.8 Display polarity.** If character stroke width, modulation, and luminance values are approximately equal for both polarities, the positive polarity (dark characters on a light background) should be used.
- **7.2.8.1.9 First-surface treatment for flat panel displays.** All flat panel displays should incorporate a first-surface treatment to diminish specular reflections.

### 7.2.8.2 Liquid crystal displays

Liquid crystal displays (LCDs) are especially suited for information display in environments where ambient illumination is high. Their advantages include excellent contrast, long life, rugged design, low voltage, and low power consumption (except when backlit). Their disadvantages include slow speed, limited color capability, limited temperature range, and manufacturing problems for larger panels with higher resolution.

- **7.2.8.2.1 Ambient illumination.** LCDs should be used only with adequate levels of ambient illumination.

**Discussion.** LCD reading performance improves as ambient illumination increases over the range 20 to 1500 lx.

- **7.2.8.2.2 Polarity.** For reflective LCDs, the image should be light characters on a dark background; for backlighted (transmissive) LCDs, the image should be dark characters on a light background.
- **7.2.8.2.3 Minimize backlighting.** The use of backlighting should be minimized.

**Discussion.** LCD reading errors increase as backlighting increases over the range of 0 to 122 cd/m<sup>2</sup>.

- **7.2.8.2.4 Low ambient illumination.** If LCDs are used in the presence of low ambient illumination, users should be able to adjust the viewing angle and the amount of backlight.
- **7.2.8.2.5 Minimize off-axis viewing of backlighted LCDs.** If used, backlighted LCDs should be located so that off-axis viewing is minimized.

### 7.2.8.3 Gas plasma displays

A major advantage of gas plasma displays is the availability of very bright, high-resolution displays, some of which can be viewed in direct sunlight. Other advantages are uniformity, high resolution, large size, long life, ruggedness, and the absence of flicker. Some disadvantages are high voltage and power requirements, complex drive circuits, low luminous efficiency, and limited color capability.

- **7.2.8.3.1 Prototypes.** The use of gas plasma displays should be evaluated through prototyping before being incorporated in a new system.
- **7.2.8.3.2 Verified by users.** The acceptability of gas plasma displays should be verified by the expected users.

### 7.2.8.4 Electroluminescent displays

Electroluminescent (EL) displays may be used wherever system requirements dictate the use of transilluminated displays. They offer the advantages of light weight, conservation of panel space, low power requirements, lack of heat production, uniform distribution of illuminance, long life, elimination of parallax, and flexibility of display. They may also be used where sudden lamp failure could result in catastrophic consequences.

- **7.2.8.4.1 Applicable guidelines.** EL displays shall conform to section 7.2.8.2, liquid crystal displays.
- **7.2.8.4.2 Alphanumeric character and symbol size.** The height of alphanumeric characters and geometric or pictorial symbols shall subtend a visual angle of at least 15 min.

### 7.2.8.5 Stereoscopic displays

- **7.2.8.4.3 Prototyping.** The use of EL displays should be evaluated through prototyping before being incorporated in a new system.
- **7.2.8.4.4 Verified by users.** The acceptability of EL displays should be verified by the expected users.

There are situations in which three-dimensional images can enhance user performance or increase the "naturalness" of the presentation of complex spatial data. Three-dimensional display technology may be "stereoscopic," which requires that users wear special glasses that provide different images to the two eyes, or "autostereoscopic," which does not require any special viewing aids. Emerging technology in this area is likely to have the disadvantages of limiting the field of view, the number of viewers, and the nature of data that can be displayed.

- **7.2.8.5.1 Meaningful use.** Three-dimensional displays should be used only if the third dimension conveys a real benefit to the user.
- **7.2.8.5.2 No performance degradation.** The three-dimensional presentation of information should not slow information display, degrade image quality, or degrade other aspects of system performance.
- **7.2.8.5.3 No interocular crosstalk.** There should be no interocular crosstalk, that is, the left eye should not see the images intended for the right eye, and vice versa.
- **7.2.8.5.4 Color in three-dimensional displays.** Secondary colors should be used in coding stereoscopic images; saturated primary colors should be avoided.

**Discussion.** Saturated primary colors can produce depth perceptions by themselves, which might interfere with the stereoscopically produced depth perceptions.

- **7.2.8.5.5 Dynamic displays.** If dynamic three-dimensional displays are used, the temporal modulation of stereopsis should be approximately 1 Hz to ensure the most accurate perception of stereo motion.
- **7.2.8.5.6 Spatial separation of depth-coded objects.** Depth-coded objects should be separated spatially to eliminate disparity averaging, crowding, and repulsion.
- **7.2.8.5.7 Size scaling.** Image size should be scaled according to the disparity of the image. If accurate size perception is critical to task performance, size scaling should be done for each observer.
- **7.2.8.5.8 Luminance and depth.** Luminance should be co-modulated with stereopsis.

**Discussion.** Brightness is also a depth cue, with brighter objects being perceived as nearer.

### 7.2.8.6 Touch-interactive devices

A touch-interactive device (TID) is an input device that permits users to interact with the system by pointing to objects on the display. TIDs may degrade image quality through reduced display luminance or through reduced display resolution. These degradations can result from the overlaid device itself and from dirt on the surface resulting from touching. TIDs can also introduce parallax because of the separation between the touch surface and the image, and they can introduce glare problems.

There are six basic types of TID.

- a. **Fixed-wire** TIDs place wires, either in parallel or in a grid, in front of the display. Finger contact with the wire(s) generates the X-Y coordinates of the user's touch. This technology is associated with minimal parallax, 70 to 80% transmissivity, and a medium to high degree of TID glare.
- b. **Capacitive** TIDs consist of a transparent conductive film on a glass overlay. Touching the surface changes a small electrical signal passing through the film, and this signal is converted into a corresponding X-Y coordinate. This technology is associated with minimal parallax, 85% transmissivity, and a medium amount of TID glare.
- c. **Resistive membrane** TIDs are "sandwich" devices in which a touch results in the contact of two conductive layers. Specific current and voltage levels are associated with individual X-Y coordinates. This technology is associated with minimal parallax, 50 to 60% transmissivity, and a high amount of TID glare.
- d. **Infrared or light-emitting diode** TIDs use infrared transmitters along two perpendicular sides of the display frame and photocell receptors along the opposite sides of the frame. A user's touch breaks the matrix of light beams, generating appropriate X-Y coordinates. This technology is associated with noticeable parallax between the plane of the light beams and the screen surface, 100% transmissivity, and no TID-related glare.
- e. **Surface acoustic wave** TIDs are similar to infrared TIDs except that they use ultrasonic beams rather than light beams. X-Y coordinates are determined by differential timings in reception of the acoustic waves. This technology is associated with minimal parallax, 92% transmissivity, and a medium amount of TID glare.
- f. **Pressure-sensitive** devices use strain gauges mounted between the display screen and an overlay. Output voltages of these strain gauges are encoded into the appropriate X-Y coordinates. This technology is associated with minimal parallax and no TID glare.

Transmissivity is not affected because the overlay is built into the display screen.

- **7.2.8.6.1 Minimal parallax.** Touch-interactive devices should be selected and mounted to minimize parallax problems.
- **7.2.8.6.2 Minimal specular glare.** Touch-interactive devices should be selected and mounted to minimize specular glare.

**7.2.9 Counters, printers, and flags displays**

This section contains criteria and guidelines for direct-reading counters, printers, and flags. Exhibit 7.2.9 lists characteristics and ratings of the goodness of each of these types of display for a variety of uses.

**Exhibit 7.2.9** Characteristics and ratings of counters, printers, and flags for various uses

Use	Counters	Printers	Flags
Quantitative information	<b>(Good)</b> Minimum time and error for exact numerical value; however, cannot be read when changing rapidly.	<b>(Good)</b> Minimum time and error for exact numerical value. Provides reference records.	Not applicable
Qualitative information	<b>(Poor)</b> Numbers must be read. Position changes not easily detected.	<b>(Poor)</b> Numbers must be read. Position changes not easily detected.	<b>(Good)</b> Easily detected. Economical of space.
Setting	<b>(Good)</b> Most accurate monitoring of numerical setting. Relation to motion of setting knob less direct than for moving pointer. Not readable during rapid setting.	Not applicable	Not applicable
Tracking	<b>(Poor)</b> No gross position changes to aid monitoring.	Not applicable	Not applicable
General	Most economical of space and illumination. Scale length limited only by number of counter drums.	Limited application.	Limited application.

**7.2.9.1 Counters**

The criteria and guidelines in this section apply primarily to mechanical counters.

- **7.2.9.1.1 When to use.** Counters should be used to present quantitative data if a quick, precise indication is required and if a continuous trend indication is not required.

- **7.2.9.1.2 Mounting.** Counters shall be mounted as close as possible to the panel surface to minimize parallax and shadows, and to maximize the viewing angle.
- **7.2.9.1.3 Movement.** The counters shall move in the following ways.
  - a. Numbers shall change by snap action rather than by continuous movement.
  - b. If an observer is expected to read the numbers consecutively, the numbers shall not change faster than 2 times a second.
  - c. Clockwise rotation of the counter reset knob shall increase the counter indication or reset the counter.
  - d. Counters that indicate sequencing operations shall reset automatically upon completion of the sequence. Provision shall also be made for manual resetting. If push buttons are used for manual resetting, the force required to operate them shall not exceed 16.7 N (60 oz).
- **7.2.9.1.4 Illumination.** Counters used in areas in which ambient illumination provides display luminance below 3.5 cd/m<sup>2</sup> (1 fL) shall be self-illuminating.
- **7.2.9.1.5 Spacing between numerals.** The horizontal separation between numerals shall be between 1/4 and 1/5 the numeral width. Commas shall not be used.
- **7.2.9.1.6 Finish.** The surface of the counter drums and surrounding areas shall have a dull, matte finish to minimize glare in accordance with FAA-STD-001B.
- **7.2.9.1.7 Contrast.** The numerals shall have a high contrast with their background. For example, black on white or white on black.

### 7.2.9.2 Printers and alphanumeric hard copy displays

- **7.2.9.2.1 When to use.** Printers should be used if a visual record of data is necessary or desirable. See exhibit 7.2.9 for the characteristics and appropriate uses of printers.
- **7.2.9.2.2 Contrast.** A minimum luminance contrast of 3.0 shall be provided between the printed material and the background on which it is printed.
- **7.2.9.2.3 Illumination.** If the printed matter would not be legible in the planned operational ambient illumination, the printer shall be provided with internal illumination.

- **7.2.9.2.4 Take-up provision.** A take-up device shall be provided for printed material.
- **7.2.9.2.5 Annotation.** If applicable, printers should be mounted so that the printed matter can be annotated easily while it is still in the printer.
- **7.2.9.2.6 Legibility.** The print shall be free from character line misregistration, character tilt, and smear.
- **7.2.9.2.7 Printed tapes.** The information on tapes shall be printed in such a manner that it can be read as it is received from the machine without requiring the cutting and pasting of tape sections.
- **7.2.9.2.8 Control, replenishment, and service.** Printers shall conform to the criteria and guidelines in this standard with respect to:
  - a. the controls and displays used to start, stop, and adjust the machine and its critical operating elements,
  - b. giving a positive indication of the remaining supply of materials such as paper and ink,
  - c. operations performed by the user, such as inserting, adjusting, removing, replenishing, and replacing supplies and materials without requiring disassembly or special tools, and
  - d. operations performed on site by a technician, such as adjustments and replacements not ordinarily performed by the user.

(Same as paragraph 7.2.9.3.8 for plotters and recorders).

### 7.2.9.3 Plotters, recorders, and graphic data hard copy displays

- **7.2.9.3.1 When to use.** Plotters or recorders should be used if a visual record of continuous graphic data is necessary or desirable. See exhibit 7.2.9 for the characteristics and appropriate uses of plotters and recorders.
- **7.2.9.3.2 Visibility.** Critical graphics (those points, curves, or grids that must be observed while a recording is being made) shall not be obscured by the pen assembly, arm, or other hardware elements.
- **7.2.9.3.3 Contrast.** Luminance contrast between a plotted function and the background on which it is drawn shall be at least 1.0.
- **7.2.9.3.4 Take-up provision.** If necessary or desirable, a take-up device shall be provided for plotted material.



- **7.2.9.3.5 Job aids.** If it is critical to the proper interpretation of graphic data as they are being generated, a graphic overlay shall be provided. Such overlays shall not obscure or distort the data.
- **7.2.9.3.6 Smudging and smearing.** A plot shall be resistant to smudging and smearing under operational use.
- **7.2.9.3.7 Annotation.** If applicable, plotters and recorders shall be designed or mounted so that the maintainer can write on or mark the paper while it is still in the plotter or recorder.
- **7.2.9.3.8 Control, replenishment, and service.** Plotters and recorders shall conform to the criteria and guidelines in this standard with respect to:
  - a. the controls and displays used to start, stop, and adjust the machine and its critical operating elements,
  - b. giving a positive indication of the remaining supply of materials such as paper and ink,
  - c. operations performed by the user, such as inserting, adjusting, removing, replenishing, and replacing supplies and materials without requiring disassembly or special tools, and
  - d. operations performed on site by a technician, such as adjustments and replacements not ordinarily performed by the user.

(Same as paragraph 7.2.9.2.8 for printers).

#### 7.2.9.4 Flags

- **7.2.9.4.1 When to use.** Flags should be used to display qualitative, nonemergency conditions. See exhibit 7.2.9 for the characteristics and appropriate uses of flags.
- **7.2.9.4.2 Mounting.** Flags shall be mounted as close to the surface of the panel as possible without restricting their movement and without obscuring necessary information.
- **7.2.9.4.3 Snap action.** Flags shall operate with a snap action.
- **7.2.9.4.4 Contrast.** Luminance contrast between a flag and its background shall be at least 3.0 under all expected lighting conditions.
- **7.2.9.4.5 Malfunction indication.** If a flag is used to indicate the malfunction of a visual display, the malfunction position of the flag shall obscure part of the maintainer's view of the malfunctioning display and shall be readily apparent to the maintainer under all expected lighting conditions.
- **7.2.9.4.6 Legend.** If a legend is provided on a flag, the lettering shall appear upright when the flag assumes the active position.

## 7.3 Audio displays

### 7.3.1 General

- **7.2.9.4.7 Test provision.** A convenient means shall be provided for testing the operation of flags.

This section presents general criteria and guidelines for audio displays, verbal warning signals and messages, controls for audio warning devices, and voice communication systems.

- **7.3.1.1 Single audio displays.** A single audio display should be used in conjunction with multiple visual displays only if immediate identification of the appropriate visual display is not critical to personnel safety or system performance.
- **7.3.1.2 When to use.** An audio display should be provided if any of the following conditions applies.
  - a. The information to be processed is short, simple, transitory, and requires immediate or time-based response.
  - b. The use of a visual display might be inappropriate because of (1) overburdening of the visual modality, (2) ambient light variability or limitation, (3) maintainer mobility, (4) degradation of vision by vibration, (5) other environmental considerations, or (6) anticipated maintainer inattention.
  - c. The criticality of a response to a visual signal makes supplementary or redundant alerting desirable.
  - d. It is desirable to warn, alert, or cue the maintainer for subsequent or additional responses.
  - e. Custom or usage has created anticipation of an audio display.
  - f. Voice communication is necessary or desirable.
- **7.3.1.3 Signal type.** If an audio display is used, the particular type of signal (tone, complex sound, or speech) should be the best for the intended use as indicated in exhibit 7.3.1.3.
- **7.3.1.4 False alarms.** The design of audio display devices and circuits shall minimize false alarms.
- **7.3.1.5 Failure.** An audio display device and circuit shall be designed to operate even in the event of system or equipment failure.
- **7.3.1.6 Circuit operability test.** All audio displays shall be equipped with circuit test devices or other means of testing their operation.

**Exhibit 7.3.1.3** Characteristics and ratings of audio signals for various uses

<b>Use</b>	<b>Tones (periodic)</b>	<b>Complex sounds (non-periodic)</b>	<b>Speech</b>
Quantitative indication	<b>(Poor)</b> Maximum of 5 to 6 tones absolutely recognizable.	<b>(Poor)</b> Interpolation between signals inaccurate.	<b>(Good)</b> Minimum time and error in obtaining exact value in terms compatible with response.
Qualitative indication	<b>(Poor to fair)</b> Difficult to judge approximate value and direction of deviation from null setting unless presented in close temporal sequence.	<b>(Poor)</b> Difficult to judge approximate deviation from desired value.	<b>(Good)</b> Information concerning displacement, direction, and rate presented in form compatible with required response.
Status indication	<b>(Good)</b> Start and stop timing; continuous information if rate of change of input is low.	<b>(Good)</b> Especially suitable for irregularly occurring signals, such as alarms.	<b>(Poor)</b> Inefficient; more easily masked; problem of repeatability.
Tracking	<b>(Fair)</b> Null position easily monitored; problem of signal-response compatibility.	<b>(Poor)</b> Required qualitative indications difficult to provide.	<b>(Good)</b> Meaning intrinsic in signal.
General	Good for automatic communication of limited information; meaning must be learned; easily generated.	Some sounds available with common meaning, for example a fire bell; easily generated.	Most effective for rapid, but not automatic, communication of complex, multidimensional information; meaning intrinsic in signal and context, if standardized; minimum learning required.

- **7.3.1.7 Redundant visual warning.** All nonverbal audio signals shall be accompanied by a visual signal that defines the condition.

## 7.3.2 Audio warnings and signals

### 7.3.2.1 General

- **7.3.2.1.1 General.** Audio signals should be provided, as necessary, to: (1) warn personnel of impending danger, (2) alert a maintainer to a critical change in system or equipment status, and (3) remind a maintainer of critical actions that must be taken.

- **7.3.2.1.2 Alerting and warning system.** An alerting and warning system or signal shall provide the maintainer with a greater probability of detecting the triggering condition than his or her normal observation would provide in the absence of the alerting or warning system or signal.

### 7.3.2.2 Characteristics of warning signals

- **7.3.2.2.1 Nature of signals.** Audio warning signals should consist of two elements, an alerting signal and an identifying or action signal.
- **7.3.2.2.2 Two-element signals.** If reaction time is critical and a two-element signal is used, an alerting signal of 0.5 sec duration shall be provided followed by an identifying or action signal. All essential information shall be transmitted in the first 2.0 sec of the identifying or action signal.
- **7.3.2.2.3 Single-element signal.** If reaction time is critical, signals shall be of short duration. If a single-element signal is used, all essential information shall be transmitted in the first 0.5 sec.
- **7.3.2.2.4 Caution signals.** Caution signals shall be readily distinguishable from warning signals and shall be used to indicate conditions requiring awareness, but not necessarily immediate action.
- **7.3.2.2.5 Relation to visual displays.** If used in conjunction with a visual display, an audio warning device shall be supplementary or supportive. The audio signal shall be used to alert and direct the maintainer's attention to the appropriate visual display.
- **7.3.2.2.6 Frequency range.** The frequency range of a warning signal shall be between 200 and 5,000 Hz. The preferred range is between 500 and 3,000 Hz. If the signal must be audible at a distance of 300 m (985 ft) or more, the frequency shall be below 1,000 Hz. If the signal must be heard around obstacles or through partitions, the frequency shall be below 500 Hz. The selected frequency band shall differ from the most intense background frequencies and shall be in accordance with the other criteria in this section.
- **7.3.2.2.7 Spurious signals.** The frequency of a warning tone shall be different from that of the electric power employed in the system, to preclude the possibility that a minor equipment failure might generate a spurious signal.
- **7.3.2.2.8 Audibility.** The intensity, duration, and source location of audio alarms and signals shall be compatible with the acoustical environment of the intended receiver (see paragraphs 7.3.2.3.1 and 7.3.2.3.2).
- **7.3.2.2.9 Compatibility with clothing and equipment.** If applicable, audio signals shall be loud enough to be heard and

understood through equipment or garments such as parka hoods and hearing protective devices covering the ears of a listener. If the audio attenuation characteristics of the garments are known, the intensity of the signal shall be increased to compensate for the attenuation so that it meets the audibility requirements of paragraph 7.3.2.3.1, but does not exceed the levels specified in paragraph 7.3.2.3.2.

### 7.3.2.3 Signal characteristics versus operational conditions and objectives

- **7.3.2.3.1 Audibility.** Alarms shall exceed the prevailing ambient noise level by at least 10 dB(A) or any maximum sound level with a duration of 30 sec by at least 5 dB(A), whichever is louder.
- **7.3.2.3.2 Maximum intensity.** The intensity of evacuation and emergency signals shall not exceed 115 dB(A). The intensity of other signals shall not exceed 90 dB(A). If meeting the requirement of paragraph 7.3.2.3.1 would result in levels higher than these, the ambient noise level shall be decreased so that these levels are not exceeded.
- **7.3.2.3.3 Attention.** Signals with high alerting capacities should be provided if the system or equipment imposes a requirement on the maintainer for concentration of attention. Such signals should not be so startling that they preclude appropriate responses or interfere with other functions by diverting attention away from other critical signals.
- **7.3.2.3.4 Onset and sound pressure level.** The onset of critical alerting signals should be sudden, and a relatively high sound pressure level should be provided, as specified in paragraph 7.3.2.2.8.
- **7.3.2.3.5 Dichotic presentation.** If earphones will be worn in an operational environment, a dichotic presentation should be used whenever feasible, with the signal alternating from one ear to the other by means of a dual-channel headset.
- **7.3.2.3.6 Headset.** If the maintainer will wear earphones covering both ears during normal equipment operation, the audio warning signal shall be directed to the maintainer's headset as well as to the work area.
- **7.3.2.3.7 When not to use headsets.** Binaural headsets should not be used in any operational environment with ambient noise below 85 dB(A) if that environment contains sounds that provide the maintainer with useful information and that information cannot be directed to the maintainer's headset. Such sounds may include voices, machine noise that indicates wear or malfunctions, and other auditory indications of system performance or mission status.

- **7.3.2.3.8 Multiple audio signals.** If several different audio signals will be used to alert a maintainer to different conditions, the signals shall differ discriminably in intensity, pitch, or use of beats and harmonics. If absolute identification is required, the number of signals to be identified shall not exceed four.
- **7.3.2.3.9 Coding.** If discrimination of warning signals from each other will be critical to personnel safety or system performance, audio signals shall be appropriately coded. Alarms that are perceptibly different shall correspond to different conditions that require critically different maintainer responses, such as maintenance, emergency conditions, and health hazards. These signals shall be sufficiently different to minimize the maintainer's search of visual displays.
- **7.3.2.3.10 Differentiation from routine signals.** Audio alarms intended to attract the maintainer's attention to a malfunction or failure shall be different from routine signals, such as bells, buzzers, random noises generated by air conditioning and other equipment, and normal operation noises.
- **7.3.2.3.11 Consistent signals.** The meaning of audio warning signals selected for a particular function in a system should be consistent with warning signal meanings already established for that function.
- **7.3.2.3.12 Acoustic environment.** Established signals shall be used, provided they are compatible with the acoustic environment and the requirements in this standard for voice communication systems. Standard signals shall not be used to convey new meanings.
- **7.3.2.3.13 Noninterference.** Audio warning signals shall not interfere with any other critical functions or warning signals or mask any other critical audio signals.
- **7.3.2.3.14 Separate channels.** If feasible, a warning signal delivered to a headset that might mask another essential audio signal should be delivered to one ear and the other signal to the other ear. If this is done, and if it is warranted by the operating conditions, this dichotic presentation should provide for alternation of the two signals from one ear to the other.

### 7.3.3 Verbal warning signals

- **7.3.3.1 Nature of signals.** Verbal warning signals shall consist of:
  - a. an initial alerting (nonspeech) signal to attract attention and perhaps to identify the general problem, and
  - b. a brief, standardized speech signal (that is, a verbal message) to identify the specific condition and suggest an appropriate action.

- **7.3.3.2 Intensity.** Verbal alarms for critical functions shall be at least 20 dB above the speech interference level at the operating position of the intended receiver, but shall not exceed 90 dB(A).

**Definition.** **Speech interference level** is a measure of the effectiveness of noise in masking speech. It is the arithmetic mean of the same pressure levels of interfering noise (in dB re 20 $\mu$  Pa) in the four octave bands centered on the frequencies 500, 1000, 2000, and 4000 Hz, respectively. The unit of speech interference is the decibel (dB).

- **7.3.3.3 Type of voice.** The voice used in recording verbal warning signals shall be distinctive and mature.
- **7.3.3.4 Delivery style.** Verbal warning signals shall be presented in a formal, impersonal manner.
- **7.3.3.5 Speech processing.** Verbal warning signals shall be processed only if necessary to increase or preserve intelligibility, for example, by increasing the strength of consonant sounds relative to vowel strength.

**Discussion.** If a signal must be relatively intense because of high ambient noise, peak-clipping may be used to protect the listener against auditory overload.

- **7.3.3.6 Message content.** In selecting words to be used in audio warning signals, priority shall be given to intelligibility, aptness, and conciseness in that order (see also section 7.3.5.6).
- **7.3.3.7 Critical warning signals.** Critical warning signals shall be repeated with not more than a 3 sec pause between messages until the condition is corrected or overridden by an operator or maintainer.
- **7.3.3.8 Message priorities.** A message priority system shall be established so that a more critical message shall override the presentation of any message having a lower priority. If two or more incidents or malfunctions occur simultaneously, the one generating a message of higher priority shall be presented first. After presentation of the highest priority message, remaining messages shall be presented in descending order of priority. In the event of a complete system failure, the system shall integrate previous messages and report the system failure rather than the failure of components.

## 7.3.4 Controls for audio warning devices

### 7.3.4.1 General

- **7.3.4.1.1 Automatic and manual shutoff.** If an audio signal is designed to persist as long as it contributes useful information, a

shutoff switch controllable by the maintainer, the sensing mechanism, or both, shall be provided consistent with the operational situation and personnel safety.

- **7.3.4.1.2 Automatic reset.** An automatic reset function for audio signals shall be provided, whether the signals are designed to terminate automatically, manually, or both. The automatic reset function shall be controlled by a sensing mechanism that recycles the signal system to a specified condition as a function of time or the state of the signalling system so that the warning device can sound again if the condition reappears.

### 7.3.4.2 Volume control and duration

- **7.3.4.2.1 Control of volume.** The volume (loudness) of an audio warning signal shall be designed to be controlled by the maintainer, the sensing mechanism, or both, depending upon the operational situation and personnel safety. Control movement shall be restricted to prevent reducing the volume to an inaudible level or increasing it to an unacceptably high level.
- **7.3.4.2.2 Ganging to mode switches.** Volume controls may be ganged to mode switches to provide maximum output during operational phases in which intense noise can occur and to provide reduced volume at other times. This ganging shall not be done if there is a possibility that intense noise could occur in an emergency situation during a phase in which the volume would be decreased below an audible level.
- **7.3.4.2.3 Caution signal controls.** Audio caution signals shall be provided with manual reset and volume controls.
- **7.3.4.2.4 Duration.** Audio warning signal duration shall be at least 0.5 sec, and may continue until the appropriate response is made. Completion of a corrective action by the maintainer or by other means shall automatically terminate the signal.
- **7.3.4.2.5 Duration limitations.** In an emergency situation, signals that persist or increase progressively in loudness shall not be used if manual shutoff may interfere with the corrective action required.

## 7.3.5 Voice communication systems

### 7.3.5.1 Speech transmission equipment

- **7.3.5.1.1 Frequency range.** Microphones and associated system input devices shall be designed to yield optimum response to the part of the speech spectrum most essential to intelligibility, that is, between 200 and 6,100 Hz. If the system necessitates a



narrower speech transmission bandwidth, the range shall be at least from 250 to 4,000 Hz.

- **7.3.5.1.2 Dynamic range.** The dynamic range of a microphone used with a selected amplifier shall be great enough to admit variations in signal input of at least 50 dB.
- **7.3.5.1.3 Noise cancelling microphones.** In very loud, low frequency noise environments (100 dB overall), noise cancelling microphones shall be used and shall be capable of effecting an improvement of at least 10 dB peak-speech to root-mean-square noise ratio as compared with microphones that are not noise cancelling, but that have equivalent transmission characteristics.
- **7.3.5.1.4 Pre-emphasis.** If necessary, speech system input devices should employ frequency pre-emphasis with a positive slope frequency characteristic no greater than 18 dB per octave from 140 to 1,500 Hz, and no greater than 9 dB per octave over the frequency range of 1,500 to 4,800 Hz when no clipping is used.

**Discussion.** If speech signals are to be transmitted over channels that have less than 15 dB peak-speech to root-mean-square noise ratios, peak-clipping of 12 to 20 dB may be employed at system input and can be preceded by frequency pre-emphasis.

- **7.3.5.1.5 Noise shields.** If the talker is in an intense noise field, the microphone should be put in a noise shield. Noise shields should be designed to meet the following requirements:
  - a. a volume of at least 250 cu cm (15.25 cu in) to permit a pressure gradient microphone to function normally,
  - b. a good seal against the face achieved by pressure of the hand or by tension straps,
  - c. a hole or combination of holes covering a total area of 65 sq mm (0.1 sq in) in the shield to prevent pressure buildup,
  - d. prevention of a standing wave pattern by shape or by use of sound absorbing material, and
  - e. no impediment to voice effort, mouth or jaw movement, or breathing.

### 7.3.5.2 Speech reception equipment

- **7.3.5.2.1 Frequency range.** Headphones and loudspeakers shall be subject to the same frequency response restrictions as microphones and transmission equipment. Excepted from this rule are loudspeakers used in multi-speaker installations and multiple channels fed into headphones (for example, when

several channels are to be monitored simultaneously); they shall respond uniformly ( $\pm 5$  dB) over the range of 100 to 4,800 Hz.

- **7.3.5.2.2 Use of de-emphasis.** If transmission equipment employs pre-emphasis and peak clipping is not used, reception equipment shall employ frequency de-emphasis of characteristics complementary to those of pre-emphasis only if it improves intelligibility, that is, de-emphasis shall be a negative-slope frequency response not greater than 9 dB per octave over the frequency range of 140 to 4,800 Hz.
- **7.3.5.2.3 Monitoring of speakers.** If several channels are to be monitored simultaneously by means of loudspeakers, the speakers shall be mounted at least  $10^\circ$  apart in the horizontal plane, frontal quadrant, ranging radially from  $45^\circ$  left to  $45^\circ$  right of the maintainer's normal, forward-facing position.
- **7.3.5.2.4 Filtering of speaker signals.** If additional channel differentiation is required, apparent lateral separation shall be enhanced by applying low-pass filtering (frequency cutoff,  $F_c=1,800$  Hz) to signals fed to loudspeakers on one side of the central maintainer position. If there are three channels involved, one channel shall be left unfiltered; a high-pass filter with a 1,000 Hz cutoff shall be provided in the second channel; and a low-pass filter with a 2,500 Hz cutoff shall be provided in the third channel. A visual signal shall be provided to show which channel is in use.
- **7.3.5.2.5 Use of binaural headsets.** If listeners will be working in high ambient noise (85 dB(A) or above), binaural rather than monaural headsets shall be provided. Unless operational requirements dictate otherwise, binaural headsets shall be wired so that the sound reaches the two ears in opposing phases.
- **7.3.5.2.6 Binaural headsets.** Binaural headsets should be capable of reducing the perceived ambient noise level to less than 85 dB(A). Provisions should be incorporated to furnish the same protection to those who wear glasses.

### 7.3.5.3 Design for maintainer comfort and convenience

- **7.3.5.3.1 Comfort.** Communication equipment to be worn by a maintainer, such as headphones and telephone headsets, shall be designed to preclude maintainer discomfort. For example, metal parts of a headset shall not come into contact with a user's skin.
- **7.3.5.3.2 Hands-free operation.** Maintainer microphones, headphones, and telephone headsets shall be designed to permit hands-free operation under normal working conditions. Specialized emergency equipment may be exempt from this criterion.
- **7.3.5.3.3 Accessibility of handsets.** If communication requirements necessitate the use of several telephone handsets,

### 7.3.5.4 Operating controls for voice communication equipment

the accessibility of their locations when not in use shall be determined by operational priority, that is, the most frequently or most urgently needed handset shall be the most accessible. The handsets may be color coded if the users will be able to perceive the coding under normal working conditions.

- **7.3.5.4.1 Volume controls.** Accessible volume or gain controls shall be provided for each communication receiving channel, such as loudspeakers or headphones, with sufficient electrical power to drive the sound pressure level to at least 100 dB overall, when using two earphones. The minimum setting of the volume control shall be limited to an audible level, that is, it shall not be possible to inadvertently disable the system using the volume control.
- **7.3.5.4.2 Separate controls for power and volume.** Separate controls should be provided for power (ON-OFF) and for volume control.
- **7.3.5.4.3 Combined power and volume controls.** If power and volume controls are combined because of space limitations, an easily noticeable detent position shall be provided between the OFF position and the lower end of the continuous range of volume adjustment, and the OFF position shall be labeled.
- **7.3.5.4.4 Squelch control.** If communication channels are to be continuously monitored, each channel shall be provided with a signal-activated switching device (squelch control) to suppress channel noise during no-signal periods. A manually operated ON-OFF switch shall be provided to deactivate squelching during the reception of weak signals.
- **7.3.5.4.5 Foot-operated controls.** Foot-operated controls shall be provided if a maintenance task requires the use of both hands for other operations.

**Example.** If a maintainer will normally be seated at a console that requires two-handed operation and needs access to "talk-listen" or "send-receive" switches, those switches would be provided as foot-operated switches.
- **7.3.5.4.6 Duplicate emergency controls.** If foot-operated emergency controls are provided at one of a set of work positions, and if a maintainer may need to move from one position to another, hand-operated controls for the same functions shall be provided in addition to the foot-operated controls.
- **7.3.5.4.7 Speaker and side tone.** If the same signal might be heard from a loudspeaker and a headset, the output of both shall be in phase. The side tone shall not be filtered or modified before it is received in the headset.

### 7.3.5.5 Conventional telephone systems

- **7.3.5.5.1 General.** In special environments such as control rooms, selection and placement of conventional telephone systems may be more critical than in a normal office environment. Within such specialized environments, systems selected for use shall provide a good frequency response in that portion of the spectrum essential for speech intelligibility. The standard telephone band pass of 200 to 3,300 Hz is acceptable. Handsets shall be compatible with maintainers' hand sizes and mouth-to-ear distances. Again, the standard telephone dimensions are acceptable. Handsets shall provide firm ear contact.
- **7.3.5.5.2 Cords.** Cords shall be nonkinking or self-retracting and of sufficient length to permit reasonable maintainer mobility. Cords shall be positioned to avoid entangling critical controls or becoming entangled with passing people or objects.
- **7.3.5.5.3 Handset cradles.** Vertically mounted handset cradles shall be designed and located to prevent the handset from being knocked out of the cradle by passing people or objects.
- **7.3.5.5.4 Multiple telephones.** If several telephones are located close to each other, they shall be coded to indicate circuit or function.
- **7.3.5.5.5 Press-to-talk button.** If a press-to-talk button is used, the button shall be convenient to both left- and right-handed people.
- **7.3.5.5.6 Switching.** Switching should be designed and programmed to minimize delay in making desired connections under both normal and emergency conditions.
- **7.3.5.5.7 Priority.** Switching shall be programmed to give the control room and critical functions automatic priority of access to the switching system.
- **7.3.5.5.8 Noisy environments.** In noisy environments, volume controls should be provided for loudness of ringing and speaker output.

### 7.3.5.6 Speech intelligibility

- **7.3.5.6.1 Evaluation method.** If information about the speech intelligibility of a system is needed, the most appropriate of the following methods should be selected.
  - a. If a high degree of sensitivity and accuracy is required, the ANSI standard method of measuring phonetically balanced monosyllabic word intelligibility, ANSI S3.2-1960, should be used.

- b. If test requirements are not as stringent, or if time and training do not permit the use of the ANSI method, the modified rhyme test (MRT) described in the Human Engineering Guide to Equipment Design should be used.
  - c. If estimations, comparisons, and predictions of system intelligibility are needed, the articulation index (AI) based on ANSI S3.5-1969 should be used.
- **7.3.5.6.2 Intelligibility criteria.** Speech intelligibility shall meet the criterion in exhibit 7.3.5.6.2 for the appropriate communication requirement and evaluation method.

**Exhibit 7.3.5.6.2** Speech intelligibility criteria for various communication requirements and evaluation methods

<b>Communication requirement</b>	<b>PB</b>	<b>Score MRT</b>	<b>AI</b>
Exceptionally high intelligibility; separate syllables understood	90%	97%	0.7
Normally acceptable intelligibility; about 98% of sentences correctly heard; single digits understood	75%	91%	0.5
Minimally acceptable intelligibility; limited standardize phrases understood; about 90% sentences correctly heard (not acceptable for operational equipment)	43%	75%	0.3

## 7.4 Controls

This section contains criteria and guidelines for controls in general as well as for a wide variety of specific hand- and foot-operated controls.

### 7.4.1 General

#### 7.4.1.1 Selection of controls

- **7.4.1.1.1 Distribution of workload.** Controls shall be selected and arranged so that none of a maintainer's limbs is overburdened.
- **7.4.1.1.2 Multirotation controls.** If precision over a wide range of adjustment is required, multirotation controls shall be used.
- **7.4.1.1.3 Detent stops.** If a system or unit of equipment requires operation of a control in discrete steps, a control having detent stops shall be used.

- **7.4.1.1.4 Limit stops.** If a control does not have to be operated beyond indicated end positions or specified limits, it shall have stops at the beginning and end of the range of control positions.
- **7.4.1.1.5 Characteristics of common controls.** The characteristics of different potential controls should be considered in the selection of a control for a given use. Characteristics of common controls for discrete adjustments are given in exhibit 7.4.1.1.5 (a); characteristics of common controls for continuous adjustments are given in exhibit 7.4.1.1.5 (b).

**Exhibit 7.4.1.1.5 (a) Characteristics of common controls for discrete adjustment**

Characteristics	Discrete adjustment				
	Rotary selector switch	Thumb-wheel	Hand push button	Foot push-button	Toggle switch
Large forces can be developed	-	-	-	-	-
Time required to make control setting	Medium to quick	-	Very quick	Quick	Very quick
Recommended number of control positions (settings)	3 to 24	3 to 24	2	2	2 to 3
Space requirements for location and operation of control	Medium	Small	Small	Large	Small
Likelihood of accidental activation	Low	Low	Medium	High	Medium
Desireable limits to control movement	270°	-	3mm x 30mm .13" x 1.5"	13 mm x 100mm .5" x 4"	120°
Effectiveness of coding	Good	Poor	Fair to Good	Poor	Fair
Effectiveness of visually identifying control position	Fair to good	Good	Poor †	Poor	Fair to good
Effectiveness of nonvisually identifying control position	Fair to good	Poor	Fair	Poor	Good
Effectiveness of check-reading to determine control position when part of a group of like controls	Good	Good	Poor †	Poor	Good
Effectiveness of operating control simultaneously with like controls in an array	Poor	Good	Good	Poor	Good
Effectiveness as part of a combine control	Fair	Fair	Good	Poor	Good

† Exception: when control is back-lighted and light comes on when control is activated.

**Exhibit 7.4.1.1.5 (b) Characteristics of common controls for continuous adjustment**

Characterisitcs	Continuous adjustment					
	Knob	Thumb-wheel	Hand wheel	Crank	Pedal	Lever
Large forces can be developed	No	No	Yes	Yes	Yes	Yes
Time required to make control setting	-	-	-	-	-	-
Recommended number of control positions (settings)	-	-	-	-	-	-
Space requirements for location and operation of control	Small to medium	Small	Large	Medium to large	Large	Medium to large
Likelyhood of accidental activation	Medium	High	High	Medium	Medium	High
Desireable limits to control movement	Un-limited	180°	± 60°	Un-limited	Small *	± 45°
Effectiveness of coding	Good	Poor	Fair	Fair	Poor	Good
Effectiveness of visually identifying control position	Fair‡ to good	Poor	Poor to fair	Poor §	Poor	Fair to good
Effectiveness of nonvisually identifying control position	Poor to good	Poor	Poor to fair	Poor §	Poor to fair	Poor to fair
Effectiveness of check-reading to determine control position when part of a group of like controls	Good ‡	Poor	Poor	Poor §	Poor	Good
Effectiveness of operating control simultaneously with like controls in an array	Poor	Good	Poor	Poor	Poor	Good
Effectiveness as part of a combine control	Good ¶	Good	Good	Poor	Poor	Good

\* Except for rotary which have unlimited range.  
 § Assumes control makes more than one rotation.  
 ‡ Applicable only when control makes less than one rotation. Round knobs must also have a pointer attached.  
 ¶ Effective primarily when mounted concentrically on one axis with other knobs.

- **7.4.1.1.6 Advantages and disadvantages of common controls.**  
 The advantages and disadvantages of different potential controls should be considered in the selection of a control for a given use. Advantages and disadvantages of common controls are given in exhibit 7.4.1.1.6.

## Exhibit 7.4.1.1.6 Advantages and disadvantages of common controls

Advantages	Disadvantages
<p><b>A. Knob, discrete position rotary</b></p> <p>Used when 4 or more detented positions are required; resistant to accidental actuation</p>	<p>Not recommended for 2 position functions; relatively slow</p>
<p><b>B. Knob, continuous position rotary</b></p> <p>Good for precise settings; single- or multi-turn capability</p>	<p>Potential parallax error; relatively slow; susceptible to misinterpretation if multiple turn; sensitive to accidental activation; difficult (time consuming) to re-establish setting if switch is moved inadvertently</p>
<p><b>C. Knobs, ganged</b></p> <p>Efficient use of space</p>	<p>Three-knob assembly not recommended; relatively slow; not recommended for gloved use; susceptible to erroneous settings; not recommended when frequent changes are required; one knob may move other knob if inter-knob friction exists (may require two-handed operation)</p>
<p><b>D. Thumbwheels</b></p> <p>Compact; virtually an unlimited range</p>	<p>Not recommended for fine control; slow, not recommended for high traffic functions; can cause intermediate and inadvertent inputs; susceptible to inadvertent activation; position or selection may be difficult to assess in dim light</p>
<p><b>E. Cranks</b></p> <p>Used when multiple rotations are required; fast; can handle high forces; with proper gearing can be used for either gross or fine positioning over a wide range of adjustments</p>	<p>Requires space; susceptible to accidental movement</p>
<p><b>F. Handwheels</b></p> <p>Good for high forces; suitable for two-handed use</p>	<p>Requires substantial space; not good for fine adjustments; may require two-handed operation</p>
<p><b>G. Levers</b></p> <p>Good for high forces; status is obvious</p>	<p>Large space requirements; susceptible to accidental displacement; not recommended for fine control</p>
<p><b>H. Toggle switches</b></p> <p>Used for 2 or 3 discrete positions; efficient use of space; setting is obvious to user</p>	<p>Four or more positions should be avoided; susceptible to inadvertent activation; often requires guards or shields</p>



**Exhibit 7.4.1.1.6 (continued) Advantages and disadvantages of common controls**

<b>I. Push button</b>	Efficient use of space; fast activation	State of activation is not always obvious; susceptible to accidental activation; may require secondary status indication; bulb failure can lead to erroneous interpretation of status
<b>J. Foot operated switches</b>	Can be used when hands are occupied	Susceptible to accidental activation; not recommended for critical operations, frequent use, or fine adjustments
<b>K. Pedals</b>	Use when both hands occupied; high force capability; may be used where pedal has created a stereotyped expectancy	Requires large amount of space for location and operation; susceptible to accidental activation due to them being unseen or felt (without danger of activation); controls or settings are easily identified
<b>L. Rocker switches</b>	Efficient use of space; will not snag clothing; status is obvious	Susceptible to accidental activation; can be difficult to read three-position rocker switches
<b>M. Push-pull controls</b>	Used for 2 position control; efficient use of panel space; may be used in multi-mode fashion (for example, on-off and volume control) to save space	Difficult to determine positions when used for multiple position control; susceptible to inadvertent activation
<b>N. Slide switches</b>	Can be discrete or continuous; good for large number of discrete positions; provides easy recognition of relative switch setting	Continuous slide switches susceptible to mispositioning; can be difficult to position continuous slide switch precisely
<b>O. Legend switches</b>	Good in low illumination (if self illuminated); fast activation; effective way to label switches; efficient use of panel space	Not recommended for more than two positions; state of activation is not always obvious
<b>P. Printed circuit (DIP) switches</b>	Very space efficient	Slow; usually require stylus to set; small size makes it difficult to read; may require stabilized hand to set and to avoid excess force
<b>Q. Key operated switches</b>	Prevents unauthorized operation; permits flush panel for seldom operated switches	Slow to operate; must keep track of separate key; key slot susceptible to contamination if not shielded

### 7.4.1.2 Direction of movement

- **7.4.1.2.1 Consistency of movement.** Direction of control movement shall be consistent with any related movement of an associated display or equipment component. In general, depressing a control or moving it forward, clockwise, up, or to the right shall cause a quantity to increase or cause the display or equipment component to move forward, clockwise, or up. Valve controls are exempt from this rule; their operation is specified in paragraphs 7.4.1.2.2 and 7.4.1.2.3.
- **7.4.1.2.2 Valve controls.** Rotary valve controls should move in a counterclockwise direction to open the valve.
- **7.4.1.2.3 Labeling and marking valve controls.** Valve controls shall be marked with double-ended arrows showing the directions of movement. The arrows shall be labeled at each end with the result of movement in that direction, for example, "Open" or "Close."

### 7.4.1.3 Arrangement and grouping

- **7.4.1.3.1 Grouping.** All controls that are operated sequentially in the performance of a particular task or that operate together in some other way shall be grouped together along with their associated displays. If several steps of a sequence are selected by a single control, the steps shall be arranged by order of occurrence to minimize control movements and prevent cycling through unnecessary steps. Cycling through a control's ON and OFF positions shall be avoided.
- **7.4.1.3.2 Sequential operation.** If a set of controls will be used in a fixed sequence, the controls shall be arranged to facilitate their operation, for example, they might be arranged to be operated from left to right or top to bottom.
- **7.4.1.3.3 Location of primary controls.** The most important and the most frequently used controls shall have the most favorable positions with respect to ease of seeing, reaching, and grasping (particularly rotary controls and those requiring fine settings).
- **7.4.1.3.4 Consistency.** The arrangement of functionally similar, or identical, primary controls shall be consistent from panel to panel throughout a system or unit of equipment.
- **7.4.1.3.5 Remote controls.** If controls will be operated at a position remote from the display or unit of equipment, their movement shall be consistent with the movement of the thing controlled (see paragraph 7.4.1.2.1).
- **7.4.1.3.6 Maintenance and adjustment.** In general, controls used solely for maintenance and adjustment shall be covered during normal equipment operation, but shall be readily

accessible and visible to a maintainer when required (see also paragraph 6.11.4).

- 7.4.1.3.7 Spacing.** Spacing between two controls of different types or between a single control and an obstruction shall be at least that specified in exhibit 7.4.1.3.7. Minimum spacing between two controls of the same type is specified in the exhibits listed in the diagonal cells of this exhibit. In all cases, spacing shall be increased as appropriate to accommodate the wearing of gloves, mittens, or other protective handwear.

**Exhibit 7.4.1.3.7** Minimum spacing between controls

	<b>Toggle switches</b>	<b>* Push buttons</b>	<b>Continuous rotary controls</b>	<b>Rotary selector switches</b>	<b>Discrete thumbwheel controls</b>
Toggle switches	See Exhibit 7.4.4.10.1	13 mm (0.5 in)	19 mm (0.75 in)	19 mm (0.75 in)	13 mm (0.5 in)
* Push buttons	13 mm (0.5 in)	See Exhibit 7.4.4.8.1	13 mm (0.5 in)	13 mm (0.5 in)	13 mm (0.5 in)
Continuous rotary controls	19 mm (0.75 in)	13 mm (0.5 in)	See exhibit 7.4.4.4.1	25 mm (1.0 in)	19 mm (0.75 in)
Rotary selector switches	19 mm (0.75 in)	13 mm (0.5 in)	25 mm (1.0 in)	See exhibit 7.4.4.1.1	19 mm (0.75 in)
Discrete thumbwheel	13 mm (0.5 in)	13 mm (0.5 in)	19 mm (0.75 in)	19 mm (0.75 in)	See exhibit 7.4.4.3.8

\* For push buttons not separated by barriers.

**Note.** All values are for one hand operation. Distances are measured from edge of each control.

**7.4.1.4 Coding**

- 7.4.1.4.1 Methods and requirements.** The coding of controls for a particular application, for example, by size or color, shall be governed by the relative advantages and disadvantages of each type of coding as shown in exhibit 7.4.1.4.1. If coding is used, the code shall be consistent throughout a system or unit of equipment.

**Exhibit 7.4.1.4.1** Advantages and disadvantages of different types of coding

<b>Advantages</b>	<b>Location</b>	<b>Shape</b>	<b>Size</b>	<b>Mode of operation</b>	<b>Labeling</b>	<b>Color</b>
Improves visual identification	X	X	X		X	X
Improves nonvisual identification (tactual and kinesthetic)	X	X	X	X		
Helps standardization	X	X	X	X	X	X
Aids identification under low levels of illumination and colored lighting	X	X	X	X	A	A
May aid in identifying control position (settings)		X		X	X	
Requires little (if any) training; is not subject to forgiving					X	
<b>Disadvantages</b>						
May require extra space	X	X	X	X	X	
Affects manipulation of the control (ease of use)	X	X	X	X		
Limited number of available coding categories	X	X	X	X		X
May be less effective if operator wears gloves		X	X	X		
Controls must be viewed (for example, must be within visual areas and with adequate illumination present)					X	X
<b>Note:</b> A - When transilluminated						

- **7.4.1.4.2 Location coding.** Controls with similar functions should be in the same relative location from one workstation to another and from one panel to another.
- **7.4.1.4.3 Size coding.** If controls are coded by size, the number of different sizes shall not exceed three. Controls used for the same function on different units of equipment shall be the same size. If knob diameter is the coded parameter, differences between diameters shall be at least 13 mm (0.5 in). If knob thickness is the coded parameter, differences in thicknesses shall be at least 10 mm (0.4 in).
- **7.4.1.4.4 Shape coding.** The primary intent of shape coding is to permit the identification of a knob by "feel." However, shape-coded knobs shall also be identifiable visually. If shape coding is used, the coding shall meet the following criteria.

- a. The shape coding shall not interfere with manipulation of the control.
  - b. The shape of a control knob or handle shall be identifiable tactually regardless of the position and orientation of the knob or handle.
  - c. If maintainers might be expected to wear gloves while using a control, the shapes shall be identifiable tactually through the gloves.
  - d. Each control or type of control that must be identifiable tactually shall have a distinct shape.
  - e. Knobs and handles that are coded by shape shall be positively and irreversibly attached to their shafts to preclude removal and incorrect replacement.
- **7.4.1.4.5 Color coding.** Only the following colors, identified in parentheses by their FED-STD-595 designations, shall be used: red (11105, 21105, or 31105), green (14187), orange-yellow (13538, 23538, or 33538), and white (17875, 27875, or 37875). Blue (15123) shall be used only if an additional color is absolutely necessary. Controls that are not color coded shall be black (17038, 27038, or 37038) or gray (26231 or 36231).
  - **7.4.1.4.6 Association of control with display.** If color coding is used to associate a control with its corresponding display, the same color shall be used for both the control and the display.
  - **7.4.1.4.7 Control panel contrast.** The color of a control shall provide contrast between the control and its panel background.
  - **7.4.1.4.8 Ambient lighting and limitations on color coding.** Color coding shall be compatible with the anticipated ambient lighting. Color coding shall not be used as the primary means for identifying a control if the spectral characteristics of the ambient light or the maintainer's adaptation to that light varies as a result of such factors as solar glare, filtration of light, or variation from natural to artificial light. If red lighting is to be used during any portion of a task, controls that would otherwise be coded red shall be coded orange-yellow with black striping.

#### **7.4.1.5 Compatibility with handwear and blind operation**

- **7.4.1.5.1 Compatibility with handwear.** Controls shall be compatible with any hand covering maintainers can be expected to wear in the anticipated environment. Unless otherwise specified, all dimensions cited in this section are for bare hands and must be increased as necessary if the maintainer will be likely to wear gloves or mittens.

- **7.4.1.5.2 Use of prototypes.** If the use of handwear is anticipated, the compatibility of a control with the handwear should be evaluated through the use of prototypes.
- **7.4.1.5.3 Blind operation.** If "blind" operation of a control is necessary, the control shall be either shape coded or separated from adjacent controls by at least 125 mm (5 in).

#### 7.4.1.6 Prevention of accidental actuation

- **7.4.1.6.1 Location and design.** Controls shall be designed and located so that they are not susceptible to being moved accidentally, particularly critical controls whose inadvertent operation might cause damage to equipment, injury to personnel, or degradation of system functions.
- **7.4.1.6.2 Internal controls.** Internal or hidden controls should be guarded because it is usually not obvious whether or not such controls have been disturbed, and it may be difficult and time-consuming to locate and readjust them.
- **7.4.1.6.3 Rapid operation.** Any method of guarding a control from inadvertent operation shall not preclude the operation of the control within the time required.
- **7.4.1.6.4 Methods.** As applicable, one or more of the following methods shall be used to guard a control from accidental actuation.
  - a. Locate and orient the control so that a maintainer is not likely to strike or move it accidentally in the normal sequence of control movements.
  - b. Recess, shield, or otherwise surround the control with a physical barrier.
  - c. Cover or guard the control, but without using safety or lock wire.
  - d. Provide the control with an interlock so that an extra movement is required.

**Examples.** Examples of extra movements include (1) side movement out of a detent position, (2) a pull-to-engage clutch, and (3) the prior operation of a related or locking control.

- e. Provide the control with resistance, such as viscous or coulomb friction, spring loading, or inertia, so that definite or sustained effort is required for actuation.
- f. If applicable, provide the control with a lock that prevents the control from passing through a position without delay.
- g. Use a rotary action control.

- **7.4.1.6.5 "Dead man" controls.** If the incapacitation of a maintainer might produce a critical system condition, a control that will result in shutting the system down to a noncritical operating state when input is removed -- called a "dead man control" -- shall be used.

## 7.4.2 Foot-operated controls

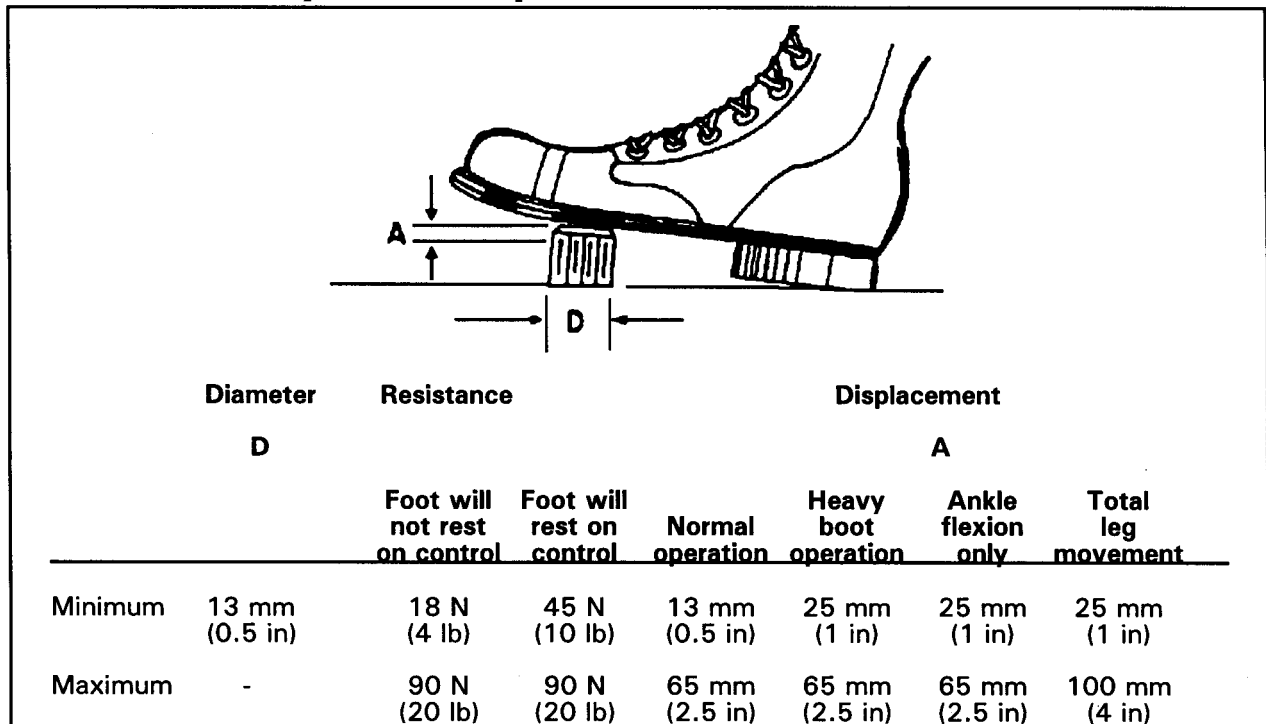
- **7.4.2.1 When to use.** Foot-operated controls should be used under the following conditions:
  - a. A control operation requires either greater force than the upper body can produce or a force close to the upper body fatigue threshold.
  - b. The maintainer's hands are expected to be occupied with other manual control tasks at the time an additional control action is needed.
  - c. A specific foot-operated control has been so well established that a maintainer would expect it, for example, aircraft rudder and brake pedals and automotive clutch, brake, and accelerator pedals.
  - d. A safety "shutdown" control is needed during an operation in which the maintainer's hands cannot be freed to reach a safety switch.
- **7.4.2.2 When not to use.** Foot-operated controls should not be used under the following conditions:
  - a. A standing maintainer is confronted with a sensitive balancing requirement, such as a moving platform, that would make it difficult to balance on one foot while operating the control with the other.
  - b. A precise control action is required.
  - c. Selection from many controls is required.
- **7.4.2.3 Operation.** Foot controls shall be located and designed so that they can be operated in as natural a way as practicable. The following shall be avoided:
  - a. frequent, maximum reaching,
  - b. requiring that the leg or foot be held in an awkward position for extended periods of time,
  - c. requiring that a maintainer operate a control frequently or for an extended period of time while sitting in an awkward or uncomfortable position,

- d. requiring frequent or prolonged application of maximum force,
  - e. requiring that a maintainer search for a particular foot control in order to select the proper one, and
  - f. placing a foot control where it might be stepped on and actuated inadvertently or where typical movement from one foot control to another creates conditions in which the foot or clothing might be entrapped by an intervening control as a maintainer moves the foot from one control to another.
- **7.4.2.4 Configuration and placement.** The configuration and placement of foot-operated controls shall accommodate a maintainer's footwear. The controls shall be located so that the actuation of a control by one foot does not interfere with the actuation of a control by the other foot and so that any required movements of feet and legs are natural and easily accomplished.

**7.4.3 Foot-operated switches**

- **7.4.3.1 Foot-operated switch specifications.** The dimensions, resistance, and displacement of foot-operated switches shall not exceed the maximum and minimum values given in exhibit 7.4.3.1. Although only one switch per foot is recommended, if it is necessary that more than one switch be operated by the same foot, those switches shall be separated by at least 75 mm (3.0 in) horizontally and 200 mm (8.0 in) vertically.

**Exhibit 7.4.3.1 Foot-operated switch specifications**





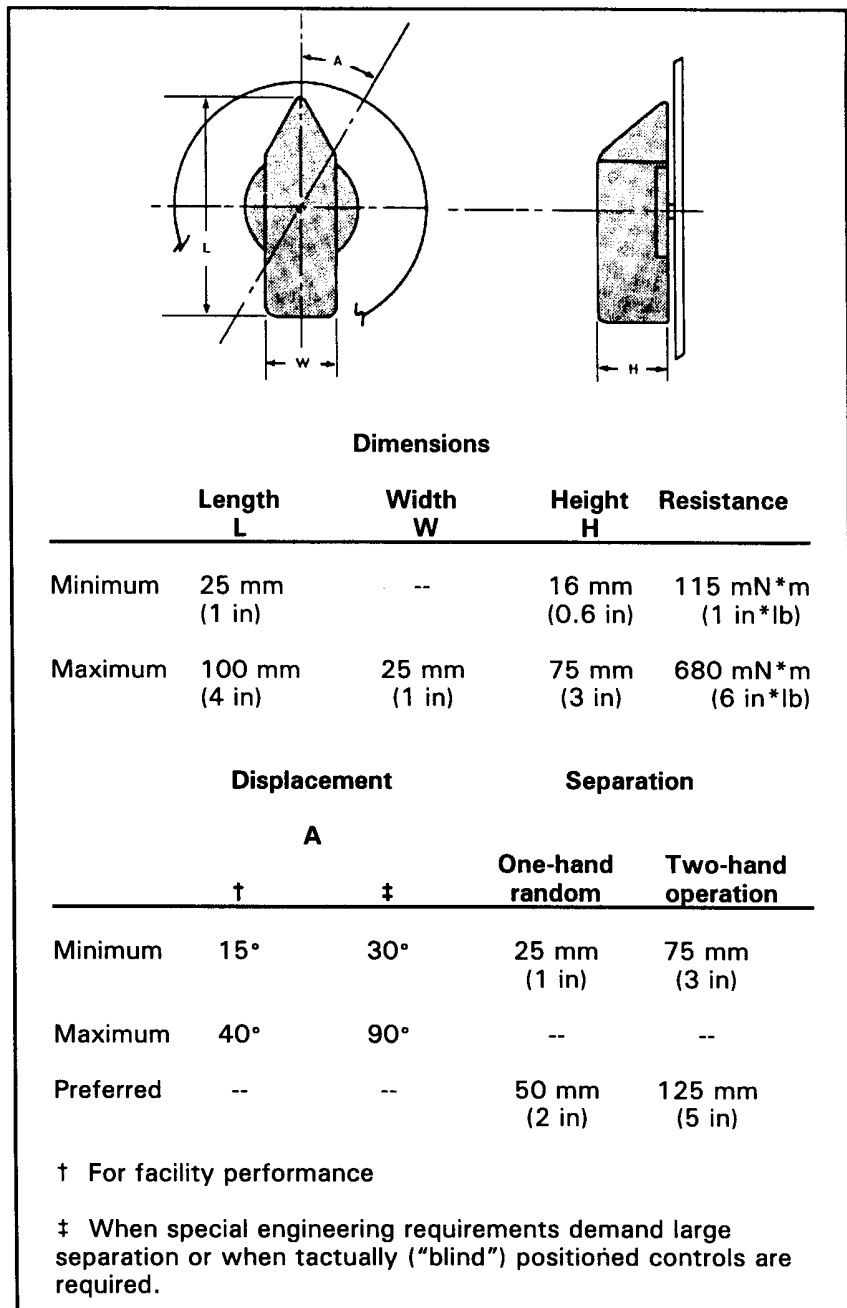
- **7.4.3.2 When to use.** Foot-operated switches should be used only if a maintainer can be expected to have both hands occupied when switch activation is required or if load sharing among limbs is desirable. Because foot-operated switches are susceptible to accidental activation, their use should be limited to noncritical or infrequent operations, such as press-to-talk communication.
- **7.4.3.3 Operation.** Foot switches shall be positioned for operation by the toe and ball of the foot rather than by the heel. They shall not be located near an obstruction that would prevent a maintainer from centering the ball of the foot on the switch button. A pedal may be used over the button to aid in locating and operating the switch.
- **7.4.3.4 Operation in wet or slippery conditions.** The switch surface should provide sufficient friction to minimize the possibility of a maintainer's foot slipping off when the switch is wet or slippery.
- **7.4.3.5 Feedback.** A positive indication of control activation shall be provided, for example, a snap action, an audible click, or feedback in a visual or auditory display.

## 7.4.4 Hand-operated controls

### 7.4.4.1 Rotary selector switches

- **7.4.4.1.1 Rotary selector switch specifications.** The dimensions, resistance, displacement, and separation between adjacent edges of areas swept by rotary selector switches should not exceed the maximum and minimum values given in exhibit 7.4.4.1.1.
- **7.4.4.1.2 When to use.** If a switch must have three or more detented positions, a rotary selector switch should be used. If only two positions are needed, a rotary switch should not be used unless prompt visual identification of the switch position is of prime importance, and speed of control operation is not critical.
- **7.4.4.1.3 Moving pointer, fixed scale.** Rotary selector switches should have moving pointers and fixed scales.
- **7.4.4.1.4 Shape.** Moving pointer knobs shall be bar-shaped, with parallel sides and with the indicating end tapered to a point, as illustrated in exhibit 7.4.4.1.1. Exceptions may be justified if pointer knobs are shape coded or if space is restricted and torque is light. Shape coding shall be used if a number of rotary controls located on the same panel and used for different functions might otherwise be confused.

Exhibit 7.4.4.1.1 Rotary selector switch specifications



- **7.4.4.1.5 Number of positions.** A rotary selector switch that is not visible to the maintainer during normal system operation shall have no more than 12 positions. A rotary selector switch that is normally visible shall have no more than 24 positions.
- **7.4.4.1.6 Placement of switch positions.** If the switch positions of a rotary switch occupy 180° or more of a circle, no two

positions shall be opposite each other unless the shape of the pointer clearly indicates which position is selected.

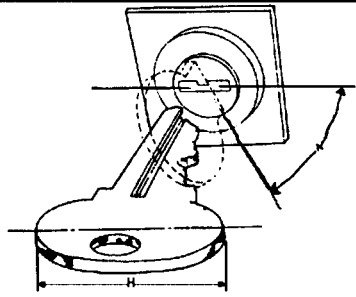
- **7.4.4.1.7 Switch resistance.** The turning resistance of a rotary switch shall increase between adjacent positions so that the switch will not stop between the positions, but rather will "snap" into one of the them.
- **7.4.4.1.8 Reference line.** A rotary switch control shall have an associated reference line. This line shall have a luminance contrast of at least 3.0 with the color of the switch control under all lighting conditions.
- **7.4.4.1.9 Parallax.** The knob pointer shall be mounted sufficiently close to its scale to minimize parallax between the pointer and scale markings. When viewed from the maintainer's normal working position, parallax errors shall not exceed 25 percent of the distance between scale markings.

**7.4.4.2 Key-operated switches**

Key-operated switches are used to prevent unauthorized operation. Ordinarily, they provide ON and OFF system operation.

- **7.4.4.2.1 Key-operated switch specifications.** The dimensions, displacement, and resistance shall not exceed the maximum and minimum values given in exhibit 7.4.4.2.1.

**Exhibit 7.4.4.2.1 Key-operated switch specifications**



	<b>Displacement (A)</b>	<b>Height (H)</b>	<b>Resistance</b>
Minimum	30°	13 mm (0.5 in)	115 mN*m (1 in*lb)
Maximum	90°	75 mm (3 in)	680 mN*m (6 in*lb)

- **7.4.4.2.2 Color, shape, and size coding.** If key-operated switches are coded by color, shape, or size, the coding shall conform to the following criteria.

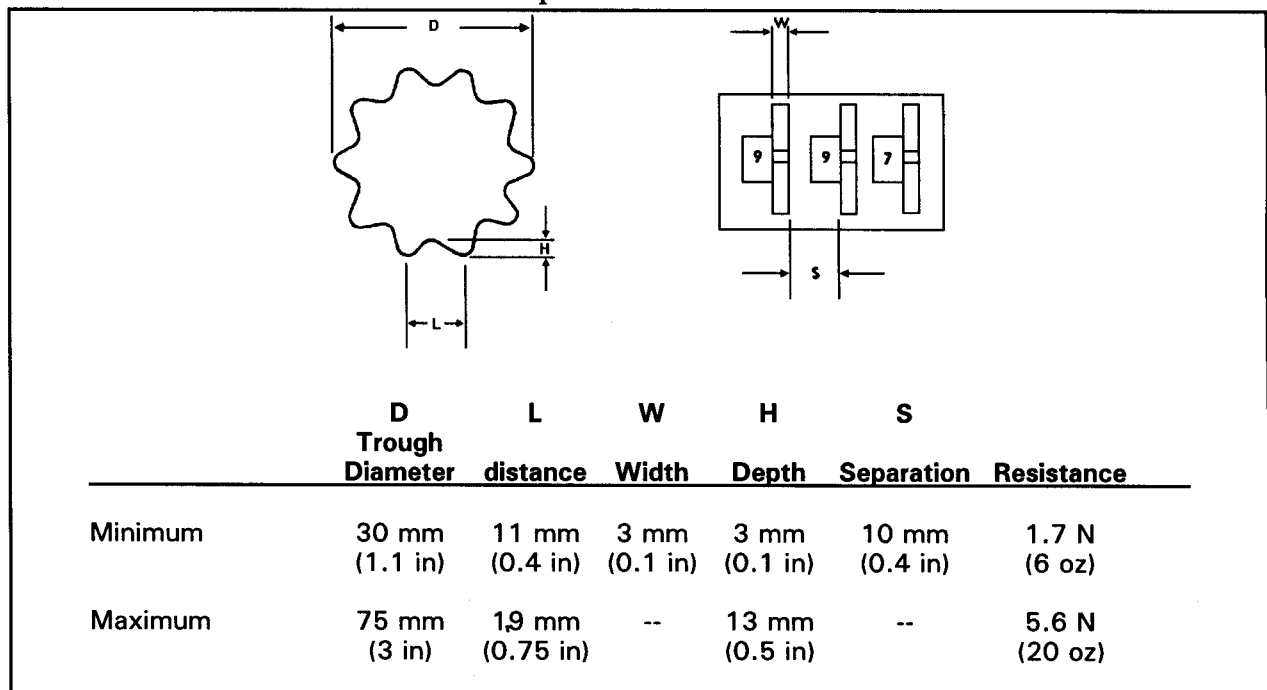
- a. Color coding shall be used only if ambient illumination is adequate to differentiate the colors.
  - b. Red shall be used only for emergency functions. Otherwise, color may be used to aid in identifying various switches by function.
  - c. If shape coding is used, sharp corners shall be avoided. Otherwise, shape coding may be used to permit the identification of a switch tactually.
  - d. If size coding is used, there shall be no more than two sizes.
- **7.4.4.2.3 Marking and labeling.** Key-operated switches shall be appropriately marked and labeled.
  - **7.4.4.2.4 Teeth on both edges.** Keys for key-operated switches shall have teeth on both edges and shall fit the lock with either side up or forward.
  - **7.4.4.2.5 Teeth on a single edge.** If paragraph 7.4.4.2.4 has been waived and keys with a single row of teeth are used, the lock shall be positioned so that the teeth point up or forward.
  - **7.4.4.2.6 ON-OFF switches.** Key-operated ON-OFF switches shall be positioned so that the key is vertical when the switch is OFF.
  - **7.4.4.2.7 Direction of rotation.** The key should turn clockwise from the vertical OFF position to the ON position.
  - **7.4.4.2.8 Key removal.** Maintainers should normally be able to remove the key from the switch only when the switch is in the OFF position.

#### 7.4.4.3 Discrete thumbwheel controls

- **7.4.4.3.1 When to use.** Thumbwheel controls should be used only if the function requires a compact digital input device, for example, to enter a series of numbers, and a readout is needed for verification.
- **7.4.4.3.2 Shape.** Each position around the circumference of a discrete thumbwheel shall have a concave surface or shall be separated by a high-friction area that is raised from the periphery of the thumbwheel. The thumbwheel shall not preclude viewing the digits within a 30° viewing angle to the left and right of a perpendicular to the thumbwheel digits.
- **7.4.4.3.3 Coding.** If a thumbwheel control includes an OFF or NORMAL position, that position should be color coded to permit a visual check that the control is in that position. Other coding methods include location and labeling.

- **7.4.4.3.4 Direction of movement.** Moving the thumbwheel edge forward, upward, or to the right shall increase the setting.
- **7.4.4.3.5 Internal illuminance and appearance of characters.** If ambient illumination will provide display illuminance less than  $3.5 \text{ cd/m}^2$  (1 fL), the thumbwheel shall be illuminated internally. Digits shall appear as illuminated characters on a black background, and their approximate dimensions shall be as follows:
  - a. height: at least 4.8 mm (0.19 in),
  - b. height-to-width ratio: 3:2, and
  - c. height-to-stroke width ratio: 10:1.
- **7.4.4.3.6 External illuminance and appearance of characters.** If ambient illumination will provide display illuminance equal to or greater than  $3.5 \text{ cd/m}^2$  (1 fL), internal illumination is not required. The digits should be bold, black numerals engraved on a light or white background. The dimensions should be approximately as those in paragraph 7.4.4.3.5, except that the height-to-stroke width ratio should be approximately 5:1.
- **7.4.4.3.7 Visibility.** A thumbwheel shall not hinder a maintainer's ability to read the setting from his or her normal working position
- **7.4.4.3.8 Dimensions.** Thumbwheel dimensions shall not exceed the maximum and minimum dimensions given in exhibit 7.4.4.3.8.

**Exhibit 7.4.4.3.8** Discrete thumbwheel specifications



- **7.4.4.3.9 Resistance.** Detents shall be provided for discrete position thumbwheels. Resistance shall increase between detents so that the thumbwheel will not rest between detents, but rather will snap into position at a detent. The resistance shall be within the limits given in exhibit 7.4.4.3.8.
- **7.4.4.3.10 Separation.** Adjacent edges of thumbwheel controls shall be separated by at least 10 mm (0.4 in). This separation shall be sufficient to preclude accidental activation of adjacent controls during use.

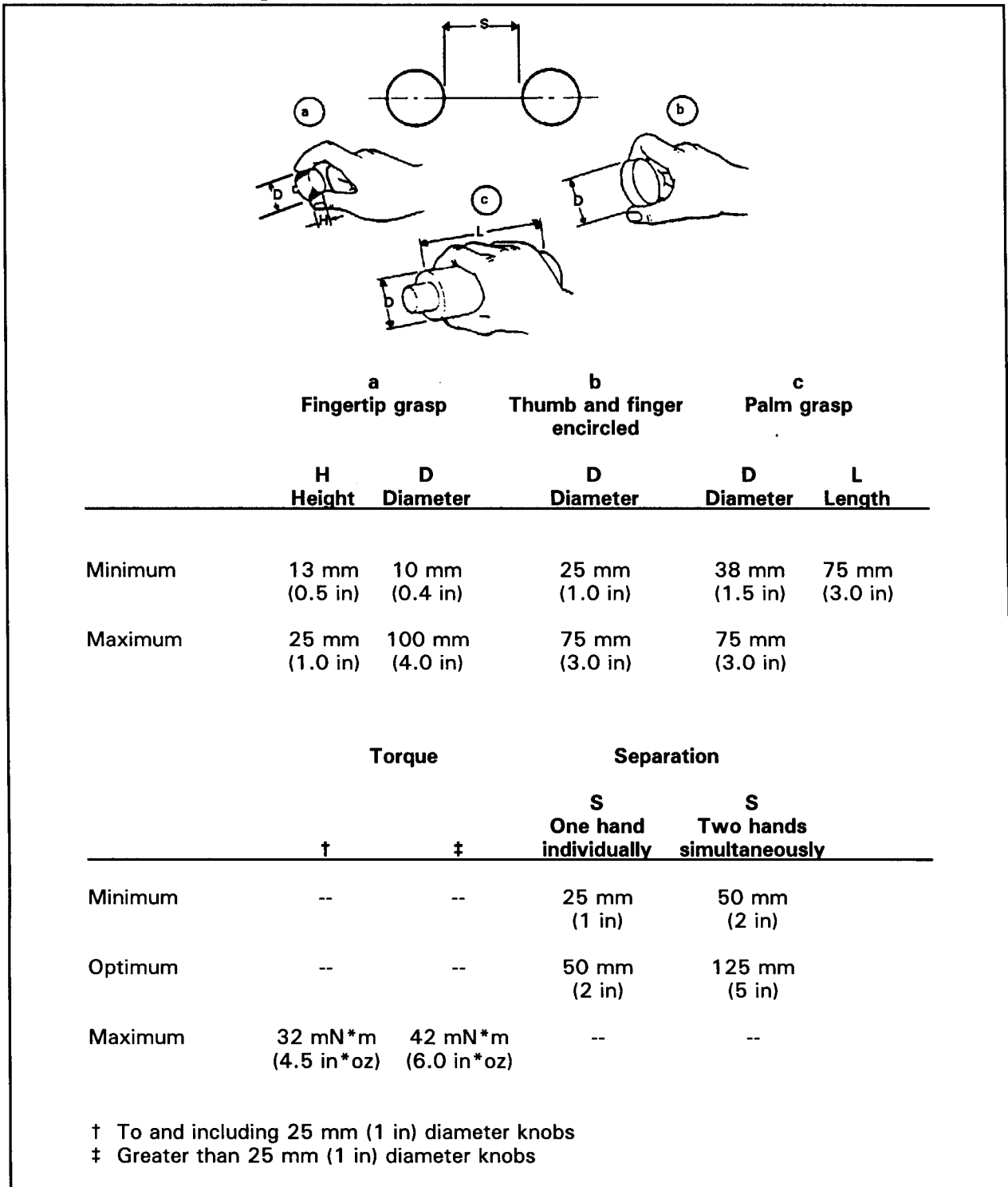
#### 7.4.4.4 Knobs

- **7.4.4.4.1 Knob specifications.** The dimensions of knobs shall not exceed the maximum and minimum values specified in exhibit 7.4.4.4.1. Torque (turning resistance) and separation between adjacent edges of knobs shall conform to the values given in the exhibit.

**Discussion.** Within the limits stated, and provided that resistance is low and that the knob can be easily grasped, knob size is relatively unimportant. If panel space is limited, knobs may approximate the minimum values, with their resistance as low as possible, but not so low that they might be turned by vibration or by a mere touch.

- **7.4.4.4.2 When to use.** A knob should be used if low force or precise adjustment of a continuous variable is required. A moving knob with a fixed scale is preferred to a moving scale with a fixed index for most tasks. If the position of a single-revolution knob must be distinguishable, the knob should have a pointer or marker.

**Exhibit 7.4.4.1 Knob specifications**




- **7.4.4.4.3 Knob style.** Rotating knob controls for different types of control actions should be distinguishable both visually and tactually. They should not be easily confused with one another. If knowledge of the position of a knob or its setting is important, the knob should be shape coded or include a pointer or other means to make its position apparent.

**7.4.4.5 Ganged control knobs**

- **7.4.4.5.1 Ganged control knob specifications.** The dimensions for two and three knob assemblies shall not exceed the maximum or minimum values given in exhibit 7.4.4.5.1. Torque (turning resistance) shall not exceed the values given in the exhibit. Separation shall be at least the minimum given in the exhibit for the appropriate type of operation.

**Exhibit 7.4.4.5.1 Ganged control knob specifications**



	Two knob assembly				Three knob assembly					
	H <sub>1</sub>	H <sub>2</sub>	D <sub>1</sub>	D <sub>2</sub>	H <sub>1</sub>	H <sub>2</sub>	H <sub>3</sub>	D <sub>1</sub>	D <sub>2</sub>	D <sub>3</sub>
Minimum	16 mm (.6 in)	13 mm (.5 in)	13 mm (.5 in)	22 mm (.9 in)	19 mm (.75 in)	19 mm (.75 in)	6 mm (.25 in)	13 mm (.5 in)	44 mm (1.75 in)	75 mm (3 in)
Maximum	-	-	-	100 mm (4 in)	-	-	-	-	-	100 mm (4 in)
	Torque		Separation							
			One hand individually		Two hand simultaneously					
	†	‡	Bare	Gloved	Bare	Gloved				
Minimum	--	--	25 mm (1.0 in)	63 mm (2.5 in)	50 mm (2.0 in)	90 mm (3.5 in)				
Optimum	--	--	50 mm (2.0 in)	90 mm (3.5 in)	75 mm (3.0 in)	100 mm (4.0 in)				
Maximum	32 mN*m (4.5 in*oz)	42 mN*m (6.0 in*oz)	--	--	--	--				
	† To and including 25 mm (1.0 in) diameter knobs									
	‡ Greater than 25 mm (1.0 in) diameter knobs									

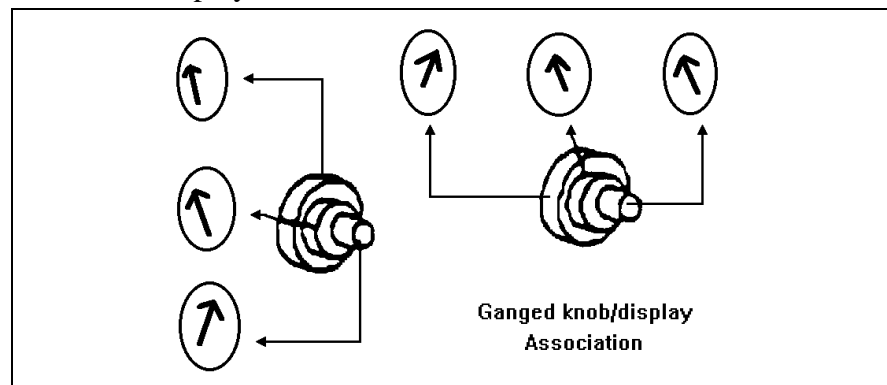
- **7.4.4.5.2 When to use.** Ganged knob assemblies should be used only if panel space is limited. When ganged assemblies are used,



the number ganged should be minimized. Three-knob assemblies should be avoided. Ganged knobs should not be used under the following conditions:

- a. Extremely accurate or rapid operations are required.
  - b. Frequent changes are necessary.
  - c. The maintainer is likely to be wearing gloves.
  - d. The equipment is likely to be exposed to weather or field conditions.
- **7.4.4.5.3 Serrations.** Knobs should be serrated. Knobs for precise adjustments should have fine serrations; knobs for gross adjustments should have coarse serrations.
  - **7.4.4.5.4 Marking.** An indexing mark or pointer shall be provided for each knob. Marks or pointers shall differ sufficiently from one knob in an assembly to another that it is apparent which indexing mark is associated with which knob.
  - **7.4.4.5.5 Knob and display relationship.** If the knobs of a ganged assembly are associated with an array of visual displays, the knob closest to the panel shall be associated with the left-most display in a horizontal array or to the uppermost display in a vertical array, as illustrated in exhibit 7.4.4.5.5.

**Exhibit 7.4.4.5.5** Relationship between ganged knobs and their associated displays



- **7.4.4.5.6 Inadvertent movement, critical.** If it is critical that one knob not be moved inadvertently while another knob is being moved, a secondary knob control movement shall be required.

**Example.** It might be necessary to press the top knob in or down to engage its control shaft.

- **7.4.4.5.7 Inadvertent movement, noncritical.** If inadvertent movement of one knob while another is being adjusted is

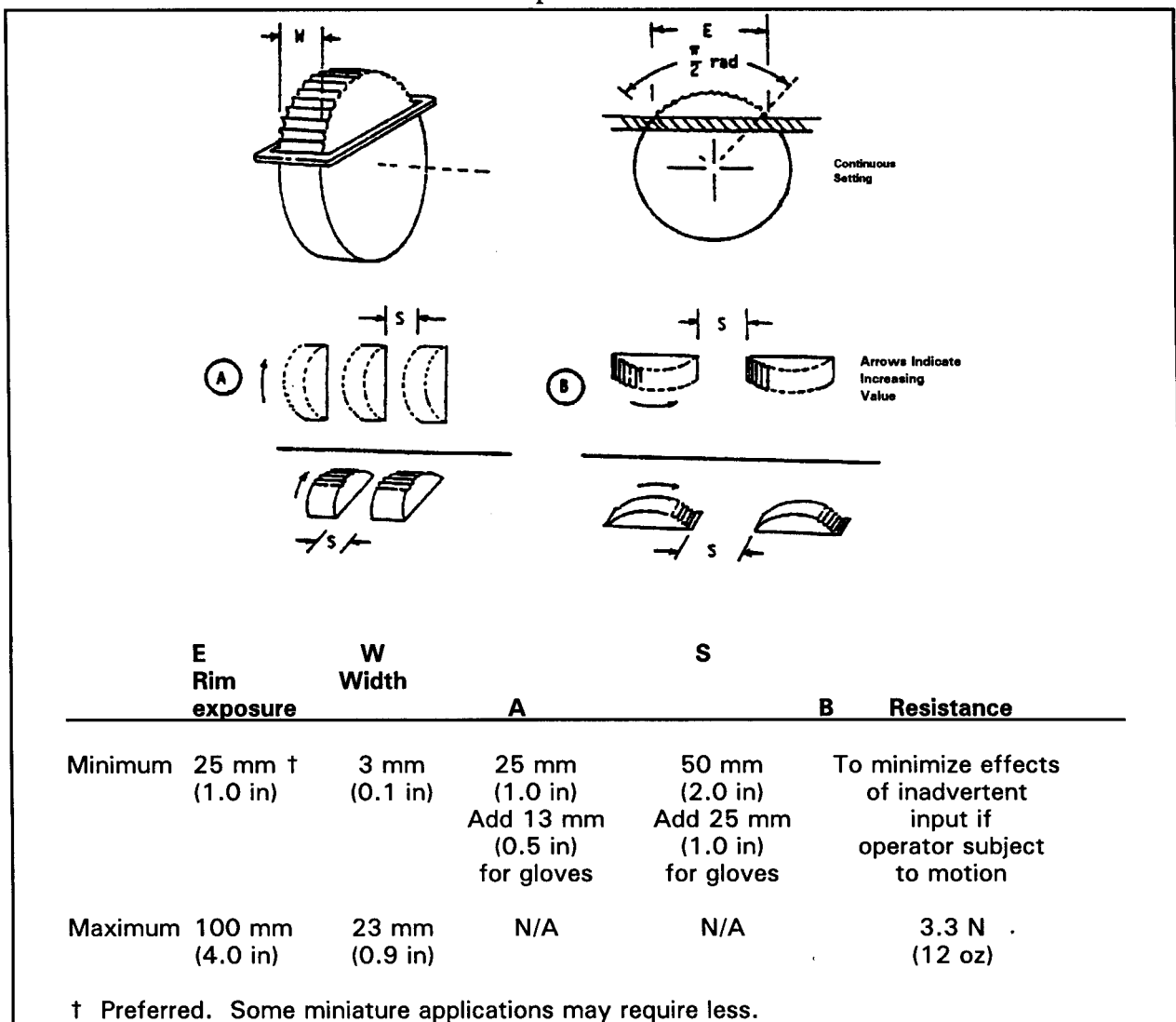
undesirable but not critical, the "optimum" separation dimensions in exhibit 7.4.4.5.1 should be used.

**Discussion.** Using different colors for the individual knobs can help in their identification.

**7.4.4.6 Continuous adjustment thumbwheels**

- 7.4.4.6.1 **Continuous thumbwheel specifications.** The dimensions, separation, and resistance of thumbwheels shall not exceed the maximum and minimum values given in exhibit 7.4.4.6.1.

**Exhibit 7.4.4.6.1 Continuous thumbwheel specifications**

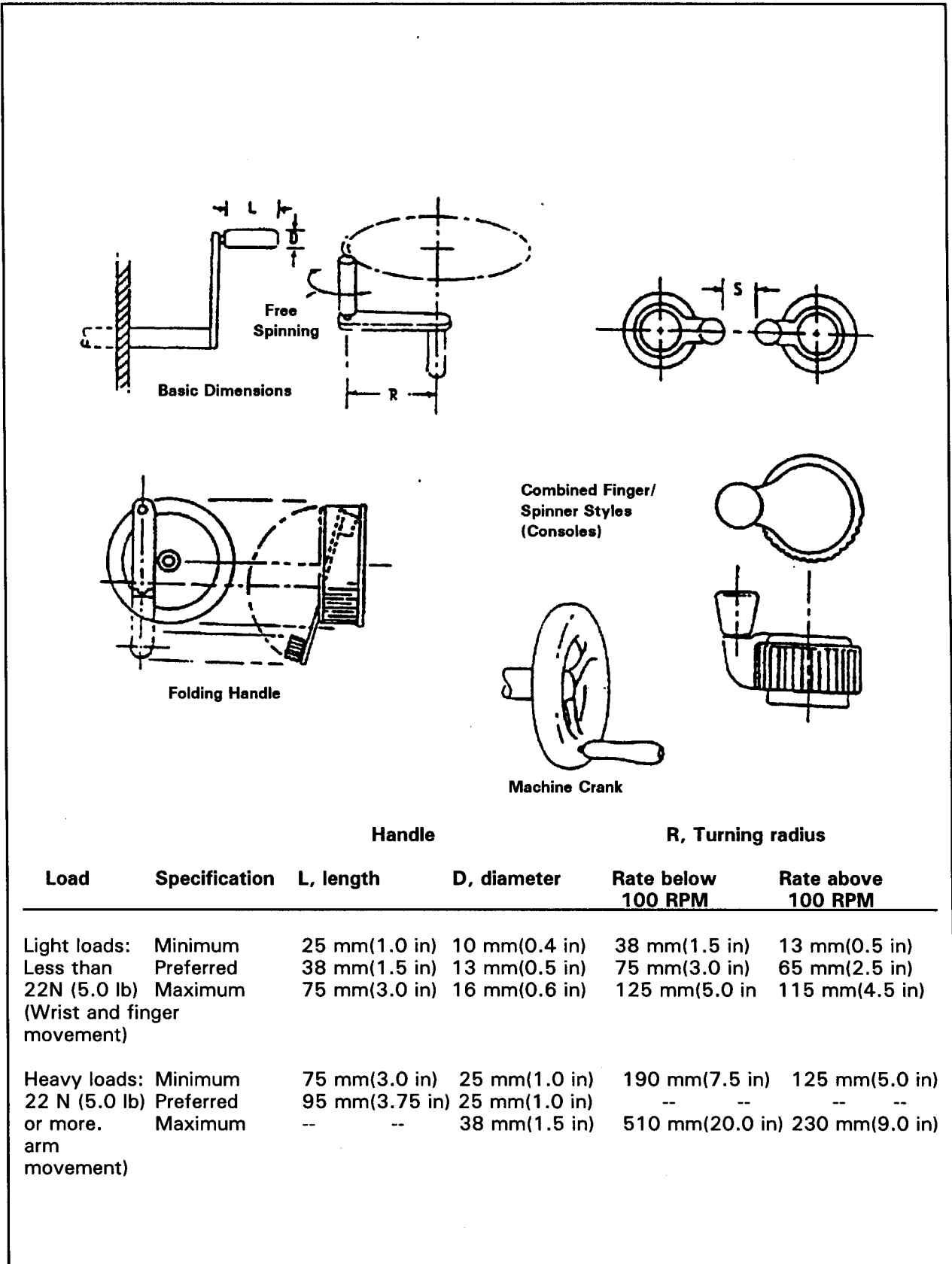


- **7.4.4.6.2 When to use.** If an application will benefit from the compactness of a thumbwheel, a continuously adjustable thumbwheel should be used rather than a rotary knob.
- **7.4.4.6.3 Orientation and movement.** Thumbwheels shall be oriented and move in the directions specified in exhibit 7.4.4.6.1.
- **7.4.4.6.4 Turning aids.** The rim of a thumbwheel shall be serrated or provided with a high friction surface to make it easy to turn.
- **7.4.4.6.5 OFF position.** A continuous adjustment thumbwheel that has an OFF position shall have a detent at that position.

#### 7.4.4.7 Cranks

- **7.4.4.7.1 Crank specifications.** The dimensions, resistance, and separation of adjacent circular swept areas of cranks shall not exceed the maximum and minimum values given in exhibit 7.4.4.7.1.
- **7.4.4.7.2 When to use.** Cranks should be used for any task that requires many rotations of a control, particularly if high rates or large forces are involved. For tasks that involve large slewing movements as well as small, fine adjustments, a crank handle may be mounted on a knob or handwheel. The crank would then be used for slewing and the knob or handwheel, for the fine adjustment. If a crank is used for tuning or another process involving numerical selection, each rotation of the crank should correspond to a multiple of 1, 10, 100, or other appropriate value. If extreme precision is required in an X-Y control, for example, in setting crosshairs or reticles in reading a map, a simultaneously-operated pair of handcranks should be used in preference to other two-axis controllers. The gear ratios and dynamic characteristics of such cranks should permit precise placement of the followers without over- or undershooting and successive corrective movements.
- **7.4.4.7.3 Grip handle.** The handle of a handcrank shall turn freely around its shaft.
- **7.4.4.7.4 Folding handles.** If a crank handle might be a hazard to persons passing by, or if it is critical that the handle not be moved inadvertently, a folding handle should be used. If a folding handle is used, it should be stable in both the extended and folded positions.
- **7.4.4.7.5 Crank balance.** In applications in which resistance is low, the crank shall be balanced so that the weight of the handle does not move the crank from its last setting.

Exhibit 7.4.4.7.1 Crank specifications

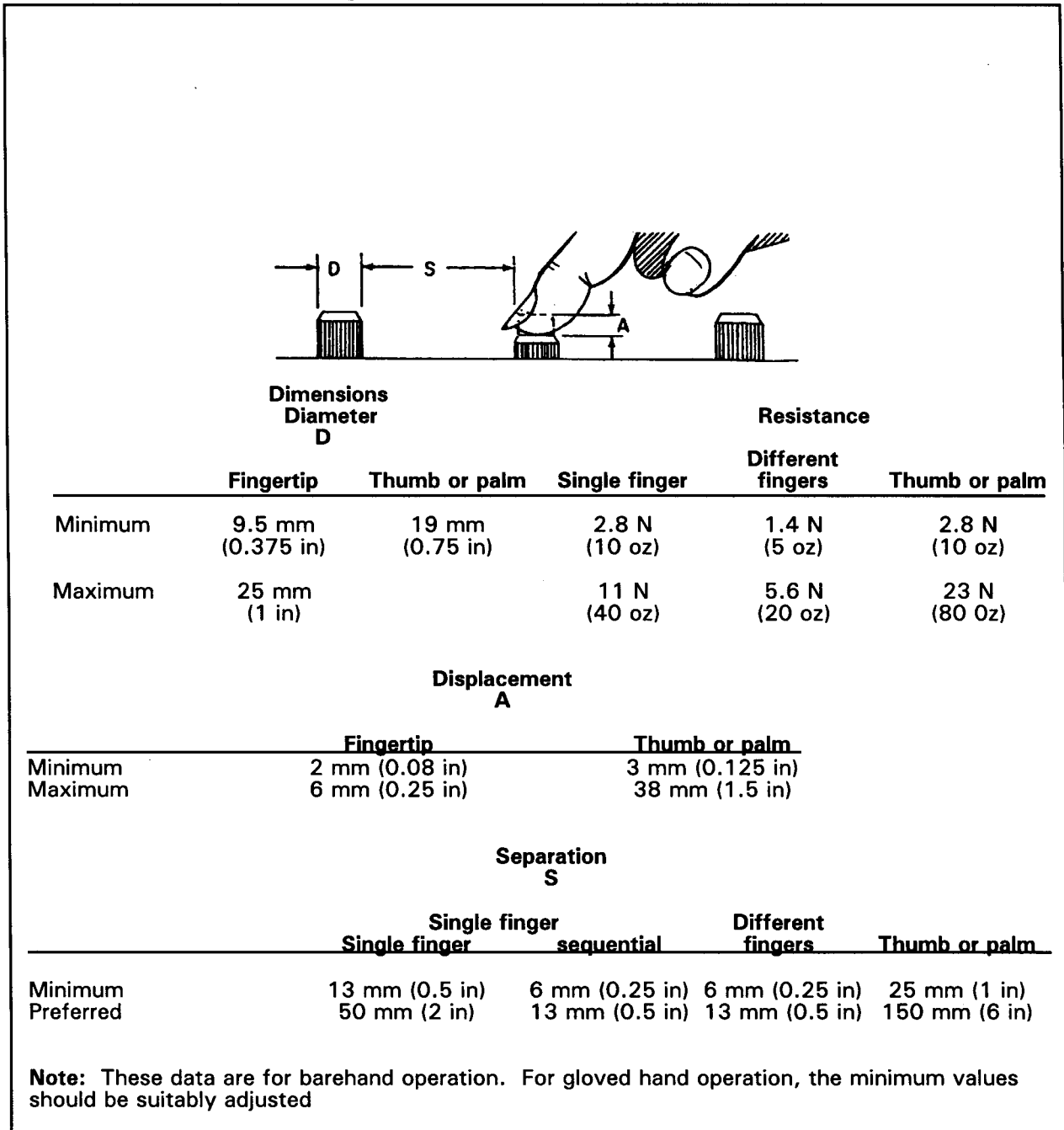


7.4.4.8 Push buttons

- 7.4.4.8.1 **Push button specifications.** The dimensions, resistance, displacement, and separation of push buttons shall not exceed the maximum and minimum values given in exhibit 7.4.4.8.1. Push buttons used in keyboards are exempt from this requirement.

**Note.** Mechanical interlocks or barriers may be used instead of the separation specified in exhibit 7.4.4.8.1.

**Exhibit 7.4.4.8.1 Push button specifications**



- **7.4.4.8.2 When to use.** Push buttons should be used if a control is needed for momentary contact or to activate a locking circuit, particularly if the control will be used frequently.
- **7.4.4.8.3 When not to use.** Push buttons shall not be used if the status of a function must be indicated by the position of its control.
- **7.4.4.8.4 Shape.** The surface of a push button should be concave to accommodate a fingertip. If it is not concave, it should have a nonslip surface.
- **7.4.4.8.5 Positive feedback.** A push button shall provide positive feedback of operation, for example, a "snap" action, an audible click, or an integral light.
- **7.4.4.8.6 Prevention of inadvertent operation.** If it is imperative that a push button not be operated inadvertently, the button shall be recessed or protected by a barrier or a cover. If a cover is used, the opened cover shall not interfere with the operation of its protected push button or adjacent controls.

#### 7.4.4.9 Keyboards

- **7.4.4.9.1 When to use.** If alphanumeric, numeric, or special function information is to be entered into a system, an arrangement of push buttons in the form of a keyboard should be used.
- **7.4.4.9.2 Numeric keyboards.** Keyboards intended solely for the entry of numbers shall have the numerals "1" through "9" arranged in a three by three array, with "0" centered below the bottom row. If the keyboard will be used primarily for communications, it shall use the "telephone" arrangement, that is, with the numerals 1, 2, and 3 in the top row. If it will be used primarily for manipulating numbers, it shall use the "calculator" arrangement, that is, with the numerals 1, 2, and 3 in the bottom row.
- **7.4.4.9.3 Alphanumeric keyboards.** Keyboards intended for the entry of both alphabetic and numeric information shall conform to the standard "QWERTY" arrangement.
- **7.4.4.9.4 Two-dimensional cursor control.** If a keyboard will be used for text processing, it shall provide for movement of the cursor in two dimensions, for example by including a set of cursor control keys.
- **7.4.4.9.5 Cursor control key layout.** If cursor control keys are included, they should be arranged in a two-dimensional array.
- **7.4.4.9.6 Consistent keyboards.** If a system contains more than one keyboard, the configuration of alphanumeric, numeric, and special function keys shall be consistent throughout the system.

- **7.4.4.9.7 Positive feedback.** When a user presses a key, feedback shall be provided to inform him or her: (1) that a key has been pressed, (2) which key has been pressed, and, if applicable, (3) that the action associated with the key has been initiated.

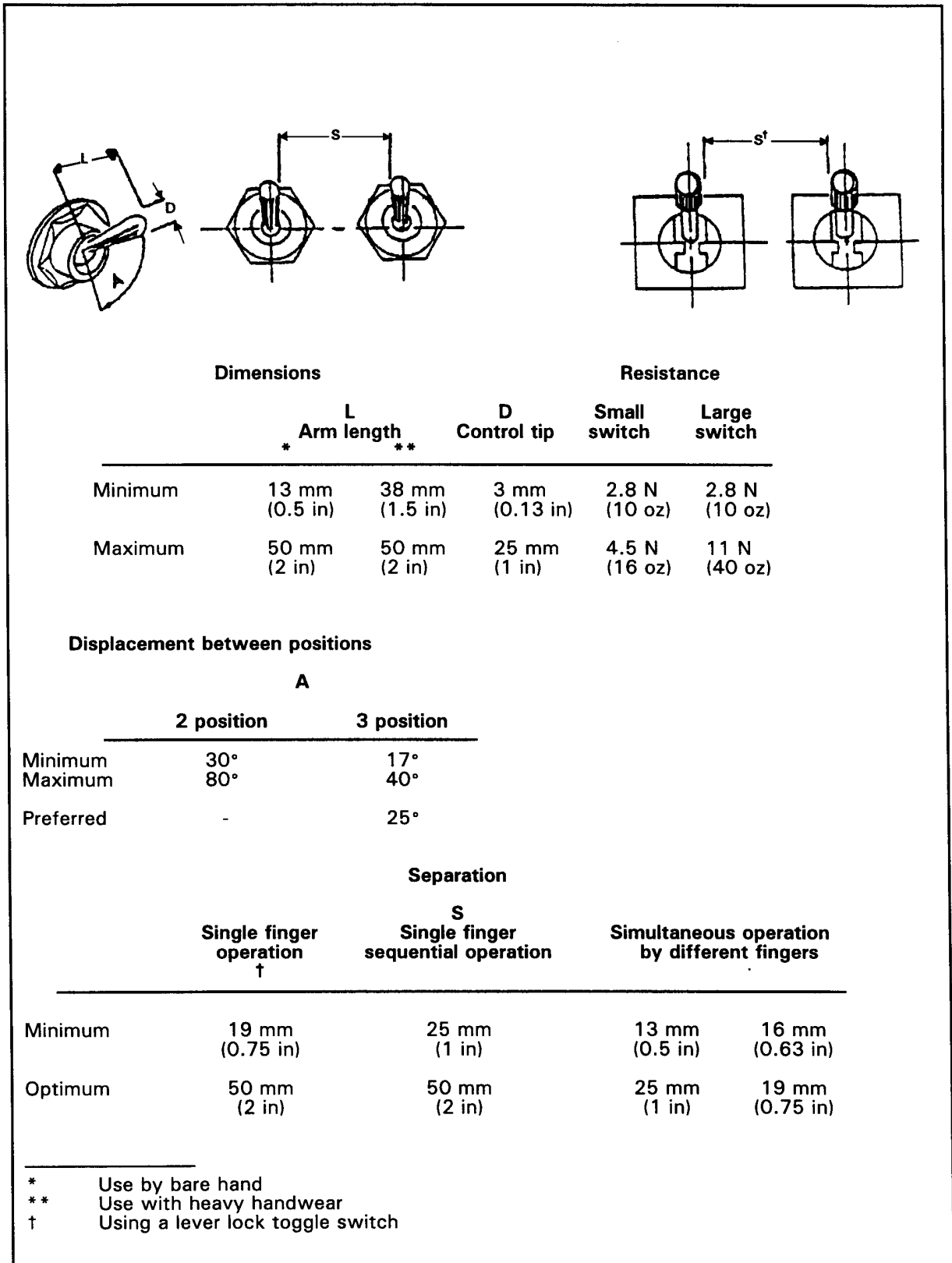
#### 7.4.4.10 Toggle switches

- **7.4.4.10.1 Toggle switch specifications.** The dimensions, resistance, displacement, and separation of toggle switches shall not exceed the maximum and minimum values given in exhibit 7.4.4.10.1. The resistance of a toggle switch shall increase as the switch is moved toward its midpoint, then decrease as the switch "snaps" into its alternate position. The switch shall not be capable of remaining between positions without being held.

**Definition.** A **toggle switch** is a switch with discrete positions operated by a lever. Controls having the same size and shape, but that allow continuous adjustment are **levers**.

- **7.4.4.10.2 When to use.** Toggle switches should be used for functions that require two discrete positions or where space limitations are severe.
- **7.4.4.10.3 Three-position toggle switches.** A toggle switch having three positions shall be used only if: (1) the use of some other type of control such as a rotary switch or a legend switch is not feasible, or (2) the toggle switch is a spring-loaded switch with the center position being the OFF position. A toggle switch that latches in one position and is spring-loaded to return to center from the other shall not be used if release from the spring-loaded position would allow the switch lever to travel past the center position.
- **7.4.4.10.4 Preventing accidental actuation.** If it is imperative that a toggle switch not be operated inadvertently, for example, if actuation might result in a critical or hazardous condition, the switch shall be protected. Protection might be by means of a barrier or a cover. Safety or lock wire shall not be used. The resistance to lifting a cover shall not exceed 13 N (3 lb). If a cover is used, it shall not interfere with the operation of the switch or of adjacent controls when it is open.
- **7.4.4.10.5 Positive feedback.** A toggle switch shall provide positive feedback, for example, a "snap" action, an audible click, or an integral or associated light.
- **7.4.4.10.6 Orientation.** Toggle switches should be oriented vertically, and, if applicable, OFF should be in the down position. A horizontal orientation should be used only to make the switch compatible with its controlled function or equipment location.

Exhibit 7.4.4.10.1 Toggle switch specifications

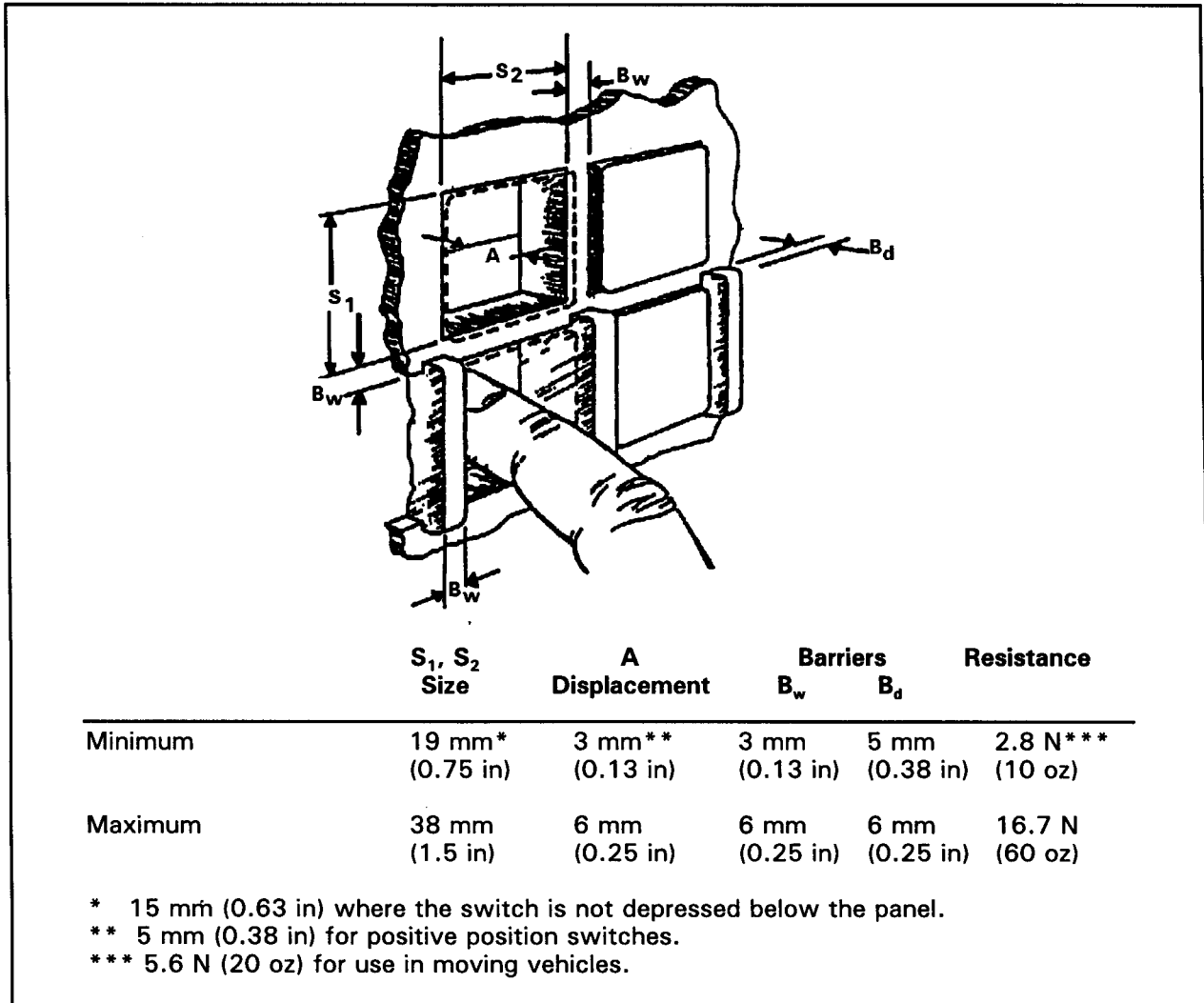




7.4.4.11 Legend switches

- 7.4.4.11.1 Legend switch specifications. The dimensions, resistance, and displacement of legend switches and the separation of adjacent legend switches shall not exceed the maximum and minimum values given in exhibit 7.4.4.11.1.

Exhibit 7.4.4.11.1 Legend switch specifications



- 7.4.4.11.2 Barriers. Critical switches and switches likely to be activated inadvertently shall have barriers unless specified otherwise. The height of barriers (measured from the surface of the panel) shall not exceed the maximum and minimum values given in exhibit 7.4.4.11.1.
- 7.4.4.11.3 Positive feedback. A legend switch shall provide positive feedback of operation, for example, a "snap" action, an audible click, or an integral or associated light.

- **7.4.4.11.4 Legibility of legend.** The legend on a legend switch shall be legible with and without internal illumination.
- **7.4.4.11.5 Lamp replacement.** The lamp within a legend switch shall be replaceable from the front of the panel by hand.
- **7.4.4.11.6 Cover replacement.** The covers of legend switches should be marked or coded to ensure that each cover can be replaced on its associated switch if it has been removed.
- **7.4.4.11.7 Legends.** The legend on a legend switch shall not exceed three lines of characters.

#### 7.4.4.12 Rocker switches

- **7.4.4.12.1 Rocker switch specifications.** The dimensions, resistance, displacement, and separation of rocker switches shall not exceed the maximum and minimum values given in exhibit 7.4.4.12.1. The resistance of a rocker switch shall increase as the upper portion is pressed down or in, then decrease so that the switch "snaps" into position. A rocker switch shall not be capable of stopping between positions.

**Discussion.** It may be desirable to color code the two portions of a rocker switch as an aid in identifying the switch's position, for example, the portion indicating ON might be one color, and the portion indicating OFF might be another.

- **7.4.4.12.2 When to use.** Rocker switches should be used rather than toggle switches if: (1) a toggle switch handle might interfere with or be interfered with surrounding activity, or (2) panel space is too limited for the labeling of toggle switch positions.
- **7.4.4.12.3 Three-position rocker switches.** Rocker switches with three positions shall be used only if: (1) the switch is spring-loaded, with the center position being OFF, or (2) the use of another type of control such as a rotary switch or a legend switch is not feasible.
- **7.4.4.12.4 Preventing accidental actuation.** If it is imperative that a rocker switch not be operated inadvertently, for example, if actuation might result in a critical or hazardous condition, the switch shall be protected, for example, with a channel guard, barrier, cover, or an equivalent protective measure.
- **7.4.4.12.5 Positive feedback.** A rocker switch shall provide positive feedback of operation, for example, a "snap" action, an audible click, or an integral or associated light.
- **7.4.4.12.6 Orientation.** If practicable, rocker switches shall be oriented vertically. Actuation of the upper portion, that is, depressing it, shall turn the equipment or component ON, cause a quantity to increase, or cause movement of a unit equipment or a

component clockwise, forward, up, or to the right. Rocker switches shall be oriented horizontally only to make the switch compatible with the controlled function or equipment location.

**Exhibit 7.4.4.12.1 Rocker switch specifications**

**Standard rocker switch:**  
Use as alternate two-position toggle switch to provide labeling surface, ease of color coding, and switch illumination.

**Narrow width, especially desirable for tactile definition with gloves.**

**Alternate (contrast) color for on versus off to provide conspicuous cue of switch position. Illuminated "on" desirable as second feedback cue.**

	Dimensions		Resistance	
	W. width	L. length		
Minimum	6 mm (0.25 in)	13 mm (0.5 in)	2.8 N (10 oz)	
Maximum			11 N (40 oz)	

	Displacement		Separation (center-to-center)	
	H, height depressed	A, angle	S (Bare hand)	S (Gloved hand)
Minimum	3 mm (0.1 in)	30°	19 mm (0.75 in)	32 mm (1.25 in)

- **7.4.4.12.7 Illumination.** If a rocker switch will be used where the ambient illumination will provide display illuminance of less than 3.5 cd/m<sup>2</sup> (1 fL), the switch should be illuminated internally.

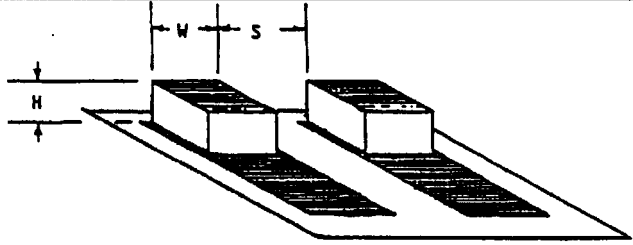
- **7.4.4.12.8 Labels.** If a rocker switch is illuminated, any alphanumeric characters shall appear as illuminated characters on an opaque background. These characters shall:

  - a. be at least 4.8 mm (0.19 in) in height,
  - b. have a height-to-width ratio of 3:2, and
  - c. have a height-to-stroke-width ratio of 10:1.

**7.4.4.13 Slide switches**

- **7.4.4.13.1 Slide switch specifications.** The dimensions, resistance, and separation of slide switches shall not exceed the maximum and minimum values given in exhibit 7.4.4.13.1. Each position of a slide switch shall have a detent. Resistance between positions shall increase and then decrease so that the switch "snaps" into position. A slide switch shall not be capable of stopping between positions.

**Exhibit 7.4.4.13.1 Slide switch specifications**



	Dimensions			Resistance	
	H Actuator height <sup>†</sup>	W Actuator width <sup>‡</sup>		Small switch	Large switch
Minimum	6 mm (0.25 in)	13 mm (0.5 in)	6 mm (0.1 in)	2.8 N (10 oz)	2.8 N (10 oz)
Maximum	-	-	25 mm (1.0 in)	4.5 N (16 oz)	11 N (40 oz)
	<b>S, separation</b>				
	Single finger operation	Single finger sequential operation		Simultaneous operation by different fingers	
Minimum	19 mm (0.75 in)	13 mm (0.5 in)		16 mm (0.6 in)	
Optimum	50 mm (2.0 in)	25 mm (1.0 in)		19 mm (0.75 in)	

<sup>†</sup> Use with bare  
<sup>‡</sup> Use with heavy handwear

- **7.4.4.13.2 Preventing accidental actuation.** If it is imperative that a slide switch not be operated inadvertently, for example, if operation might result in a critical or hazardous condition, the switch shall be protected. Protection might be by means of a channel guard, barrier, cover, or an equivalent protective measure.
- **7.4.4.13.3 Orientation.** Slide switches shall be oriented vertically, with movement of the slide up or away from the user turning the equipment or component ON, causing a quantity to increase, or causing the equipment or component to move clockwise, forward, up, or to the right. Horizontal orientation shall be used only to make the switch compatible with its controlled function or equipment location.
- **7.4.4.13.4 Positive feedback.** A slide switch that has more than two positions shall provide an indication of its setting, for example, by means of a pointer located on the side of the slide handle.

#### 7.4.4.14 Discrete push-pull controls

- **7.4.4.14.1 Push-pull control specifications.** The dimensions, displacement, and separation of push-pull controls shall not exceed the maximum and minimum values given in exhibit 7.4.4.14.1.

**Discussion.** Push-pull controls may be used to select one of two discrete functions or, if panel space is limited, to combine two related, but distinct functions, such as a combination ON-OFF switch and volume control into a single control. A three-position push-pull control may be acceptable in isolated instances in which the criticality of inadvertent selection of the wrong position has no serious consequences, for example, the OFF-parking lights-headlights switch on some automobiles.

- **7.4.4.14.2 When to use.** Push-pull controls should be used sparingly and primarily in applications in which they have been used traditionally, for example, vehicle headlight switches.
- **7.4.4.14.3 Rotation.** Push-pull controls shall normally be keyed to a nonrotating shaft. Exceptions are: (1) combination push-pull and rotate controls, and (2) special applications, for example, one in which a handle is rotated to disengage something. Combination push-pull and rotate knobs shall have a serrated rim to suggest both visually and tactually that the knob can be rotated and to help prevent fingers from slipping when they turn the knob.
- **7.4.4.14.4 Detents.** Push-pull controls shall have detents to provide tactile indication of positions.

**Exhibit 7.4.4.14.1 Push-pull control specifications**

	<p>Push-pull control, low resistance, for two-position, mechanical and electrical systems. Alternate three position plus rotary function acceptable for application such as vehicle headlight plus parking lights, panel and dome lights. Provide serrated rim.</p>	<p><b>Minimum diameter (D)</b></p>	<p><b>Minimum clearance (C)</b></p>	<p><b>Displacement</b></p>	<p><b>Minimum space (S) between controls:</b></p>	
		<p>19 mm (0.75 in)</p>	<p>25 mm (1.0 in) add 13 mm (0.5 in) for gloved hand</p>	<p>12-38 mm (0.5-1.5 in) Minimum between pull positions: 13 mm (0.5 in)</p>	<p>38 mm (1.5 in) add 13 mm (0.5 in) for gloved hand</p>	
	<p>Alternate handle; miniature electrical panel switch only. Avoid glove use application.</p>	<p><b>Minimum diameter (D)</b></p>	<p><b>Minimum clearance (C)</b></p>	<p><b>Minimum length</b></p>	<p><b>Minimum displacement</b></p>	<p><b>Minimum space between (S)</b></p>
		<p>6.5 mm (0.25 in)</p>	<p>N/A</p>	<p>19 mm (0.75 in)</p>	<p>13 mm (0.5 in)</p>	<p>25 mm (1 in)</p>
	<p>High force push-pull, for two-position mechanical system only.</p>	<p><b>Minimum width (W)</b></p>	<p><b>Depth (D)</b></p>	<p><b>Minimum clearance (C)</b></p>	<p><b>Minimum displacement</b></p>	
		<p>100 mm (4 in)</p>	<p>16-38 mm (0.6-1.5 in)</p>	<p>38 mm (1.5 in) add 6 mm (0.24 in) for gloved hand</p>	<p>25 mm (1 in) Preferred: 50 mm (2 in)</p>	
	<p>Same as above. The following values are preferred where possible garment or cable-snag possibility exists.</p>	<p><b>Minimum width (W)</b></p>	<p><b>Depth (D)</b></p>	<p><b>Minimum clearance (C)</b></p>	<p><b>Minimum displacement</b></p>	<p><b>Minimum space between (S)</b></p>
		<p>100 mm (4 in)</p>	<p>16-38 mm (0.6 in - 1.5 in)</p>	<p>38 mm (1.5 in)</p>	<p>25 mm (1 in) Preferred: 50 mm (2 in)</p>	<p>13 mm (0.5 in)</p>
<p><b>Note.</b> 1 and 2 finger pulls are also acceptable for less than 18 N (4.0 lb) application</p>						

- **7.4.4.14.5 Snagging and inadvertent operation.** Push-pull controls shall be designed and located to prevent:

  - a. the snagging of clothing, wires, and cables,
  - b. their being bumped by passers by, and

- c. their being bumped by someone reaching for or operating another nearby control.
- **7.4.4.14.6 Direction of movement.** The direction of movement of a push-pull control shall conform to the following:
  - a. Pulling the control toward the user shall turn ON or actuate the associated equipment or function; pushing the control away from the user shall turn OFF or deactivate the equipment or function.
  - b. Turning a combination push-pull and rotary control clockwise shall actuate or increase the function.
- **7.4.4.14.7 Resistance.** The force required to push or pull a panel control with the fingers should not exceed 18 N (4 lb). The force required to push or pull a T-bar with four fingers should not exceed 45 N (10 lb).

#### 7.4.4.15 Printed circuit switches

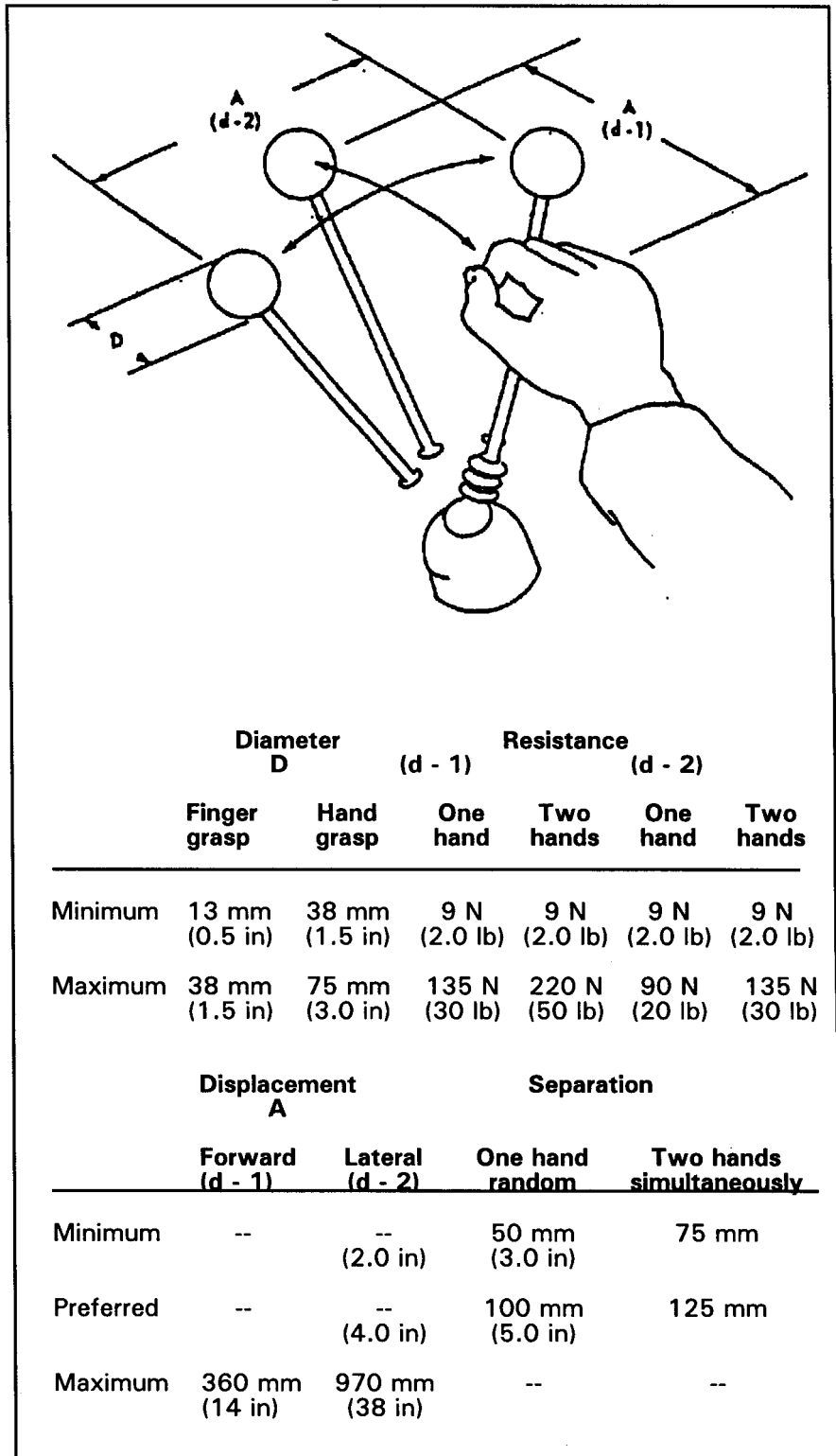
Printed circuit (PC) switches may be used if manual programming functions are needed in systems that employ printed circuit boards.

- **7.4.4.15.1 Dimensions.** PC switches shall be large enough to permit error-free manipulation by a person using a pencil or pen. PC switch actuators shall not require the use of a special tool for their operation.
- **7.4.4.15.2 Resistance.** The resistance of a PC switch shall be high enough to avoid inadvertent actuation under the expected conditions of use. The resistance shall increase to a maximum halfway between positions, then decrease again so that the switch actuator "snaps" into position. The actuator shall not be capable of stopping between positions.
- **7.4.4.15.3 Displacement.** Sliding PC switch actuators shall have enough displacement to permit easy identification of the switch position. Displacement shall be at least twice the width or thickness of the actuator. If rocker switches are used, the actuated portion of the switch shall be flush with the panel surface.
- **7.4.4.15.4 Separation.** If two or more PC switches are grouped together, their actuators shall be far enough apart to permit error-free operation of the individual switches.
- **7.4.4.15.5 Shape.** The surface of the actuator shall be indented to accept the point of a pen or pencil. The indentation shall be deep enough that the point does not slip as the actuator is manipulated.

#### 7.4.4.16 Levers

- **7.4.4.16.1 Lever specifications.** The dimensions, resistance, displacement, and separation of levers shall not exceed the maximum and minimum values given in exhibit 7.4.4.16.1.

Exhibit 7.4.4.16.1 Lever specifications



**Note.** The dominant hand can supply slightly more force than the nondominant hand, but the difference is not



significant. The same amount of push-pull force can be applied when the control is along the median plane of the body as when it is directly in front of the arm, 180 mm (7 in) from the median plane. If the control is placed in front of the opposite (unused) arm, only 75 percent as much force can be applied. If the control is 250 to 480 mm (10 to 19 in) forward of the seat reference point, twice as much push-pull force can be applied with two hands as with one-hand operation. Outside this range, two-hand operation becomes less effective.

- **7.4.4.16.2 When to use.** Levers should be used if a large amount of force is needed, or if multidimensional movement of the control is needed.
- **7.4.4.16.3 Coding.** If several levers are located near one another, the lever handles shall be coded.
- **7.4.4.16.4 Labeling.** If practicable, all levers shall be labeled with their function and direction of motion.
- **7.4.4.16.5 Limb support.** If a lever will be used to make fine or continuous adjustments, a support for the appropriate limb shall be provided as follows:
  - a. For large hand movements, a support for the elbow shall be provided.
  - b. For small hand movements, a support for the forearm shall be provided.
  - c. For finger movements, a support for the wrist shall be provided.

#### **7.4.4.17 Hand-operated displacement joysticks**

Joystick controls are appropriate for tasks that require precise or continuous control in two or more related dimensions. Their primary uses are for cursor positioning and for precise adjustments.

**Definitions.** A **displacement joystick** is a joystick that moves in the direction it is pushed. Displacement joysticks are usually spring-loaded so that they return to their center position. An **isometric joystick** responds to the amount and direction of pressure applied to it, but it does not move. Displacement joysticks usually require less force than isometric joysticks and are thus less fatiguing over long operating periods.

- **7.4.4.17.1 Specifications.** The handgrip length of a hand-operated displacement joystick shall be in the range 110 to 180 mm (4.3 to 7.1 in); the grip diameter shall not exceed 50 mm (2 in); clearance shall be at least 100 mm (4 in) to the side and 50 mm (2 in) to the rear. If the joystick is contained in a separate module, the module shall be mounted to allow operation of the joystick without the base slipping, moving, or tilting.

- **7.4.4.17.2 Movement characteristics.** Movement shall not exceed 45° from the center position. Movement shall be smooth in all directions, and positioning of a follower shall be attainable without noticeable backlash, cross-coupling, or need for multiple corrective movements. If the joystick is to be used for generating free-drawn graphics, the CRT shall have a refresh rate sufficiently high to give the appearance of a continuous track when the follower is moved. Delay between control movement and the confirming display response shall be minimized and shall not exceed 0.1 sec.
- **7.4.4.17.3 When to use.** If accuracy is more important than speed, a displacement joystick should be used rather than an isometric joystick. If a displacement joystick is used for rate control, the joystick should be spring-loaded so that it returns to center. If a joystick will have a secondary control, a displacement joystick should be used rather than an isometric joystick.

**Discussion.** Uses of displacement joysticks include: (1) picking data from a CRT, (2) generating free-drawn graphics, (3) controlling a vehicle, (4) aiming sensors, and (5) serving as a mounting platform for a secondary control such as thumb- or finger-operated switches.

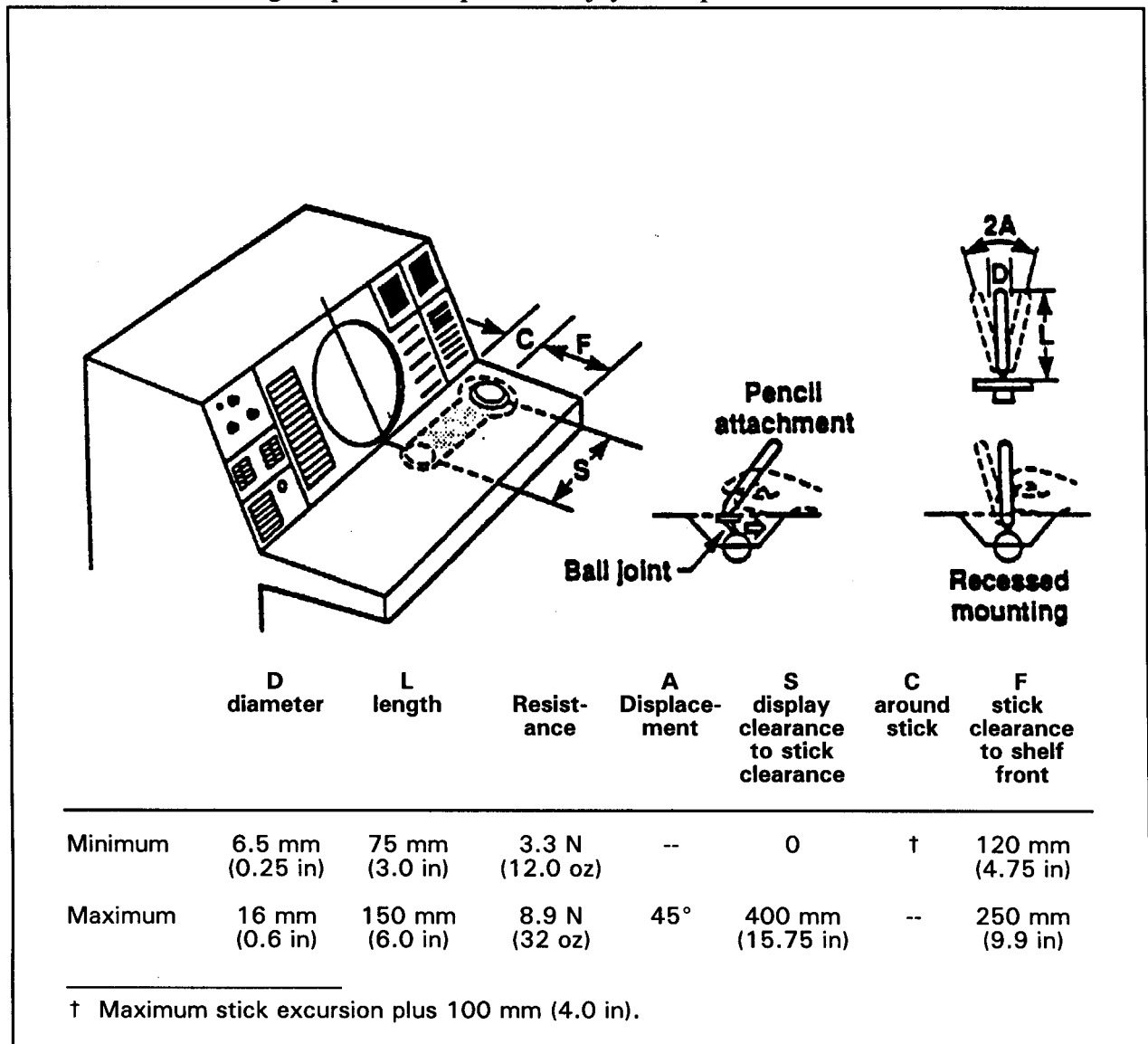
- **7.4.4.17.4 When not to use.** Displacement joysticks shall not be used with automatic sequencing of a CRT cursor or tracking symbol if they have a dead band near the center or hysteresis. An exception may be made if they are instrumented for null return or zero-set to the instantaneous position of the joystick at the time of sequencing. Upon termination of the automatic sequencing routine, the joystick center shall again be registered to the scope center.

#### **7.4.4.18 Finger-operated displacement joysticks**

Finger-operated displacement joysticks are useful for free-drawn graphics. In this application, they are not usually spring-loaded to return to center. It is desirable that they have sufficient friction to remain in their last position when the hand is removed.

- **7.4.4.18.1 Finger-operated displacement joystick specifications.** The dimensions, resistance, and clearance of finger-operated displacement joysticks shall not exceed the maximum or minimum values given in exhibit 7.4.4.18.1.
- **7.4.4.18.2 Mounting.** The joystick shall be mounted in a way that provides forearm or wrist support. If the joystick is a separate modular device, the module shall be mounted so that the joystick can be manipulated without slippage, movement, or tilting of its base.
- **7.4.4.18.3 Movement characteristics.** Movement shall not exceed 45° from the center position. Movement shall be smooth in all directions, and positioning of a follower shall be attainable without noticeable backlash, cross-coupling, or need for multiple corrective movements. Control ratios, friction, and inertia shall

**Exhibit 7.4.4.18.1** Finger-operated displacement joystick specifications



meet the dual requirements of rapid gross positioning and precise fine positioning. Recessed mounting or pencil attachments may be used as indicated in exhibit 7.4.4.18.1 to provide greater precision of control. If the joystick is to be used for generating free-drawn graphics, the CRT shall have a refresh rate sufficiently high to give the appearance of a continuous track when the follower is moved. Delay between control movement and the confirming display response shall be minimized and shall not exceed 0.1 sec.

**7.4.4.19 Thumbtip and fingertip-operated displacement joysticks**

- 7.4.4.19.1 **Usage.** Thumbtip and fingertip-operated displacement joysticks may be mounted on a handgrip, which can serve as a

steady rest to damp vibration or increase precision. If they are so mounted, the handgrip shall not itself also function as a joystick.

- **7.4.4.19.2 Mounting.** Thumbtip and fingertip-operated displacement joysticks shall be mounted in a way that provides wrist or hand support. Console-mounted joysticks shall be mounted as shown in exhibit 7.4.4.18.1.
- **7.4.4.19.3 Movement characteristics.** Movement shall not exceed 45° from the center position. If the joystick is a separate modular device, the module shall be mounted so that the joystick can be manipulated without slippage, movement, or tilting of its base.

#### 7.4.4.20 Hand-operated isometric joysticks

Isometric joysticks are also known as "stiff" sticks, "force" sticks, and "pressure" sticks. These joysticks have no perceptible movement, but they can respond to the amount and direction of pressure applied. They are appropriate for tasks requiring precise or continuous control movement in two or more related dimensions. They are particularly appropriate for applications in which: (1) there is a need for return to a precise center after each use, (2) feedback to the user is primarily visual rather than tactual from the control itself, and (3) there is minimal delay and tight coupling between the control and system reaction. They may also be used as mounting platforms for secondary controls, such as thumb- and finger-operated switches, although operation of secondary controls is more likely to induce error on an isometric handgrip than on a displacement handgrip.

- **7.4.4.20.1 Specifications.** The handgrip length of a hand-operated isometric joystick shall be in the range of 110 to 180 mm (4.3 to 7.1 in). The grip diameter shall not exceed 50 mm (2 in). Clearances of 100 mm (4 in) to the side and 50 mm (2 in) to the rear shall be provided to allow for hand movement. The maximum force for full output shall not exceed 118 N (26.7 lb).
- **7.4.4.20.2 Mounting.** Hand-operated isometric joysticks shall be mounted in a way that provides forearm support. If the joystick is a separate modular device, the module shall be mounted so that the joystick can be manipulated without slippage, movement, or tilting of its base.

#### 7.4.4.21 Thumbtip and fingertip-operated isometric joysticks

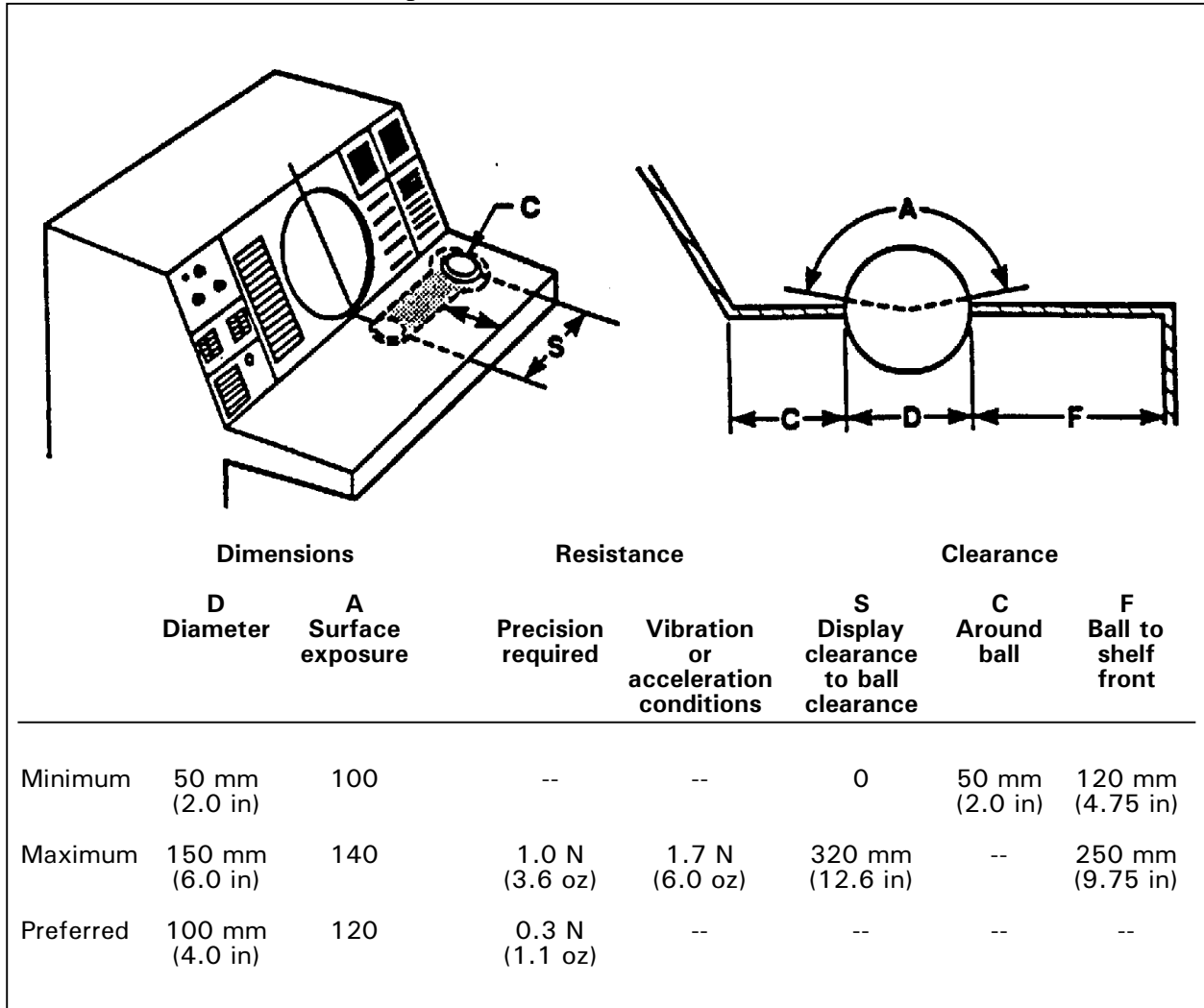
- **7.4.4.21.1 Mounting.** Thumbtip- and fingertip-operated isometric joysticks shall be mounted in a way that provides wrist or hand support. They may be mounted on a handgrip that serves as a steady rest to damp vibrations or to increase precision. If they are so mounted, the handgrip itself shall not function simultaneously as a joystick controller. Console-mounted joysticks shall be mounted as shown in exhibit 7.4.4.18.1. If the joystick is a separate modular device, the module shall be mounted so that the joystick can be manipulated without slippage, movement, or tilting of its base.

7.4.4.22 Ball controls

Other names for ball controls are "track ball," "ball tracker," "joyball," and "rolling ball."

- 7.4.4.22.1 Specifications. The dimensions, exposure, resistance, and clearance of ball controls shall not exceed the maximum and minimum values given in exhibit 7.4.4.22.1.

Exhibit 7.4.4.22.1 Ball control specifications



- 7.4.4.22.2 Limb support. If a ball control will be used to make precise or continuous adjustments, a wrist or arm support or both shall be provided.
- 7.4.4.22.3 Movement characteristics. A ball control shall be capable of rotation in any direction so as to generate any combination of X and Y output values. When moved in either the X or Y direction alone, the control shall exhibit no apparent cross-coupling (that is, movement of the follower in the orthogonal direction). There shall be no backlash apparent to the user. Control ratios and dynamic features shall meet the dual requirements of rapid gross positioning and smooth, precise fine positioning.

- **7.4.4.22.4 When to use.** Ball controls rotate freely in all directions; therefore, they are suitable for applications such as data pickoff and accumulative travel, however, they do not provide for automatic return to a point of origin. Ball controls should be used only as position controls, that is, applications in which a movement of the ball produces a proportional movement of a follower on a display.
- **7.4.4.22.5 Movement of a follower off a display.** If the application allows a ball control to move its follower off the edge of a display, the application shall advise the user how to bring the follower back onto the display.

#### 7.4.4.23 Grid and stylus devices

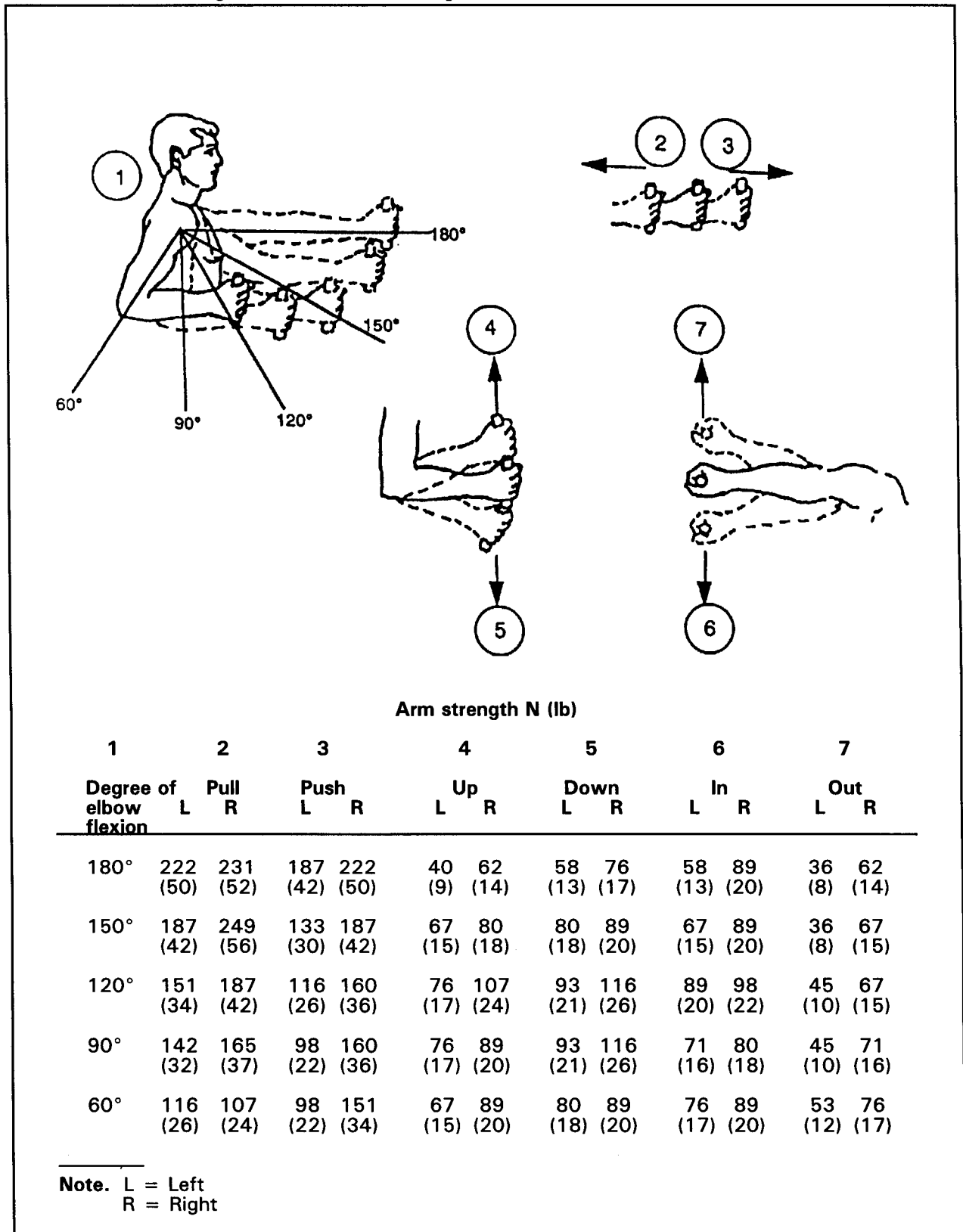
Grid and stylus devices may be transparent media placed directly on a display, or they may be located elsewhere, in a location that makes stylus manipulation convenient.

- **7.4.4.23.1 Specifications.** A transparent grid used as an overlay on a display shall conform to the size of the display. A grid that is displaced from the display shall conform as closely as possible to the size and orientation of its related display. The display shall contain a follower that appears at the position on the display that corresponds (that is, has the same coordinate values) to the location of the stylus on the grid.
- **7.4.4.23.2 Dynamic characteristics.** Movement of the stylus in any direction on the grid surface shall result in smooth movement of the follower in the same direction. Discrete placement of the stylus at any point on the grid shall cause the follower to appear at the corresponding coordinates and to remain steady in position as long as the stylus is not moved. The refresh rate of the follower shall be sufficiently high to ensure the appearance of a continuous track whenever the stylus is used for the generation of free-drawn graphics.
- **7.4.4.23.3 When to use.** Grid and stylus devices may be used for data pickoff from a CRT, the entry of points onto a display, the generation of free-drawn graphics, and similar control applications. These devices should be used only for zero order control functions, that is, applications in which displacement of the stylus from a reference position causes a proportional displacement of the follower.

#### 7.4.4.24 Hand controls requiring high force

- **7.4.4.24.1 Specifications.** Arm, hand, and thumb-finger controls that require high control force shall not exceed the limits given in exhibit 7.4.4.24.1. The values in the exhibit are for males. If the control will be used by females, the limits should be reduced by one-third.

Exhibit 7.4.4.24.1 High-force hand control specifications



- **7.4.4.24.2 When not to use.** In general, controls requiring forces greater than the strength limits of the weakest segment of the expected user population shall not be used. In addition, high force controls shall not be used unless the user's normal working position provides proper body support, limb support, or both. Sustained application of high force (that is, durations longer than 3 sec) shall be avoided.

#### 7.4.4.25 Miniature controls

- **7.4.4.25.1 Dimensions and separation.** The dimensions and separation of miniature controls shall be the maximum permitted by the available space up to the maximum values specified in this standard for standard-sized controls of the same type.
- **7.4.4.25.2 Resistance and displacement.** The resistance and displacement of miniature controls should be the same as the resistance and displacement of standard-sized controls of the same type.
- **7.4.4.25.3 When to use.** Miniature controls shall be used only if severe space limitations exist. They shall not be used if space is adequate for standard-size controls, and they shall not be used if users are likely to wear gloves or mittens.
- **7.4.4.25.4 Other requirements.** Other design considerations, such as labeling and orientation, shall conform to those in this standard for standard-size controls of the same type.

## 7.5 Labeling and marking

Design criteria and guidelines for labels, markings, and colors for controls and displays are given in this section.

In this section, the term "label" is intended to include legends, placards, signs, and markings.

### 7.5.1 General

Label characteristics need to be consistent with requirements for accuracy of identification, time available for recognition or other responses, distance at which the labels must be read, illumination level and color, criticality of the function labeled, and label design within and among controls and displays.

- **7.5.1.1 Use.** Labels shall be provided whenever it is necessary for users: (1) to locate and identify controls and displays, (2) to interpret and follow procedures, or (3) to avoid hazards.
- **7.5.1.2 Size graduation.** The characters identifying controls and displays shall be larger than the characters identifying control positions. The smallest characters shall be determined by viewing conditions. The dimensions of characters of a given label shall be at least approximately 25 percent larger than the characters of the next smaller label.



- **7.5.1.3 Demarcation with size graduation.** To best apply size graduation, the components should be functionally grouped and demarcated or spaced to reveal system and subsystem groupings.
- **7.5.1.4 General requirements.** Controls and displays shall be appropriately and clearly labeled with the basic information needed for proper identification, use, activation, or manipulation of the element.
- **7.5.1.5 Principles of labeling.** Labels shall:
  - a. give the user relevant information needed to perform his or her task (for example, make or model of equipment)
  - b. be supplemented where appropriate with other coding such as color and shape (as in warning or danger signs),
  - c. use only boldface type to emphasize words or phrases, and
  - d. if appropriate, be etched or embossed into the surface for durability, rather than stamped, stenciled, or printed.
- **7.5.1.6 Avoid similar labels.** Similar names for different controls and displays shall be avoided.
- **7.5.1.7 Meaningful labels.** Controls and displays shall be labeled in terms of what is being measured or controlled, taking into account the user (and maintainer) as well as the purpose of the control or display.
- **7.5.1.8 Function labels.** The labels for controls shall indicate the functional result of control movement such as increase, ON, and OFF and include calibration data where applicable. Such information shall be visible during normal operation of the control.
- **7.5.1.9 Functional relationship.** If controls and displays must be used together (as, for example, in certain adjustment tasks), appropriate labels shall indicate their functional relationship. The selection and use of terminology shall be consistent.
- **7.5.1.10 Label mounting.** Labels that are not part of the equipment or component shall be securely attached to prevent their loss, damage, slippage, or accidental removal. They shall be attached to a structural member that is not removed during equipment servicing or routine maintenance.
- **7.5.1.11 Label removal.** Maintainers should be able to remove a label without damaging the surface to which it was attached.
- **7.5.1.12 Curved labels.** Curved labels (for example, a label that is wrapped around a pipe or cable) shall be avoided.

- **7.5.1.13 Label reflectance.** Labels shall be constructed of nonreflective materials to avoid illegibility due to a light source being reflected back to the viewer.
- **7.5.1.14 Units of measurement.** Applicable units of measurement such as volts or psi shall be included in labels.
- **7.5.1.15 Tag mounting.** If tags are used, they should be attached securely to equipment components by means of durable stranded stainless steel cable, clamps, or chains. The length of the cable, clamp, or chain should be minimal so that the tag will not interfere with the operation or maintenance of the equipment.

## 7.5.2 Location and orientation

- **7.5.2.1 Readability.** Control and display labels shall be located so that they are visible and readable with the control or display in its installed position (same as paragraph 6.3.5.2.1 for equipment).
- **7.5.2.2 No obstruction.** Labels shall not be located where they obscure other information needed by the user or maintainer. Additionally, they shall not be located where a control or maintainer's normal hand or arm position will obscure the label.
- **7.5.2.3 Position near control or display.** Labels shall be placed very near the control or display that they identify.
- **7.5.2.4 Above control or display.** Labels should normally be placed above the control or display they describe. For a control or display located above eye level, labels may be located below the control or display if label visibility will be enhanced.
- **7.5.2.5 Separate labels.** Adjacent labels should be separated by sufficient space so they are not read as one continuous label.
- **7.5.2.6 Functional grouping.** Labels shall be used to identify functionally grouped controls and displays. If a line is used to enclose a functional group and define its boundaries, the label shall be centered at the top of the group either in a break in the line or just below the line. If colored areas are used and sufficient space is available, the label shall be centered at the top within the area. If there is insufficient room for the label in this position it shall be located in the best available space provided the grouping is demarcated. The summary label may be bordered or otherwise highlighted to make it stand out.
- **7.5.2.7 Consistent location.** Labels on similar controls and displays should be placed in approximately the same location on each (same as paragraph 6.3.5.2.3 for equipment).
- **7.5.2.8 Hierarchical labeling.** A hierarchical labeling scheme should be used on panels to reduce confusion and search time. Major labels should be used to identify major systems or

maintainer workstations, subordinate or group labels should identify subsystem or functional groups, and component labels should identify each panel or console element. Labels should not repeat information contained in higher-level labels.

- **7.5.2.9 Horizontal orientation.** Labels shall be oriented so that alphanumeric characters are read horizontally, not vertically (same as paragraph 6.3.5.2.4).
- **7.5.2.10 Preserving readability.** Labels shall be located so that they will not become obscured by dirt, moisture, or other foreign materials. If these materials are likely to accumulate, the labels shall be mounted on a vertical surface (same as paragraph 6.3.5.2.2 for equipment).

### 7.5.3 Typographic matters

- **7.5.3.1 Character height for viewing distance.** Unless circumstances require otherwise, labels shall be clearly legible at a viewing distance of 710 mm (28 in). The recommended height for letters and numerals at this distance is approximately 5 mm (0.18 in). Exhibit 7.5.3.1 gives minimum character heights for other viewing distances (same as paragraph 6.3.5.3.1).

**Exhibit 7.5.3.1** Minimum character height for various viewing distances under normal luminance levels

Viewing distance	Minimum height
Less than 0.5 m (20 in)	2.3 mm (0.1 in)
0.5 - 1.0 m (20 - 40 in)	4.7 mm (0.2 in)
1.0 - 2.0 m (40 - 80 in)	9.4 mm (0.4 in)
2.0 - 4.0 m (80 - 160 in)	18 mm (0.75 in)
4.0 - 9.0 m (13 - 30 ft)	38 mm (1.5 in)

- **7.5.3.2 Stroke width in normal illumination.** If labels are expected to be read under normal illumination, characters shall be black on a white or light background, and stroke width shall be 1/6 to 1/7 of the height (same as paragraph 6.3.5.3.2).
- **7.5.3.3 Stroke width in dim illumination.** If labels are expected to be read under dim illumination, characters shall be white on a black or dark background, and stroke width shall be from 1/7 to 1/8 of the height (same as paragraph 6.3.5.3.3).
- **7.5.3.4 Stroke width for transilluminated characters.** For transilluminated characters, the stroke width shall be 1/10 of the height.
- **7.5.3.5 Width to height ratios.** The width-to-height ratio of letters and numerals shall be 3:5 with the exceptions of "M" and

"W," which shall be 4:5, "4," which shall be one stroke width wider, and "I" and "1," which shall be one stroke wide (same as paragraph 6.3.5.3.4).

- **7.5.3.6 Character spacing.** The spacing between characters shall be at least one stroke width (same as paragraph 6.3.5.3.5).
- **7.5.3.7 Word spacing.** The spacing between words shall be approximately the width of one normal-width character (same as paragraph 6.3.5.3.6).
- **7.5.3.8 Line spacing.** The minimum space between lines shall be approximately one-half the character height (same as paragraph 6.3.5.3.7).
- **7.5.3.9 Case of letters.** If the text on a label is exclusively single words, such as names, the words shall appear as all capital letters; if the text is phrases or sentences, the text shall appear as mixed case letters (same as paragraph 6.3.5.3.8, for equipment).

#### 7.5.4 Design of label characters

- **7.5.4.1 Contrast.** If the ambient illumination will be above 10 lux (0.9 ft-c), dark characters on a light background shall be used.

**Discussion.** Black letters on a white background offer the best contrast. Good contrast is also provided by black on yellow, dark blue on white, dark green on white, and dark red on white.

- **7.5.4.2 Dark adaptation.** If dark adaptation is required, the displayed alphanumeric characters shall be visible without interfering with night vision requirements. If possible, markings shall be white on a dark background.
- **7.5.4.3 Style or font.** A simple font without serifs should be selected, such as Helvetica or Univers.

**Example.** This sentence is written in a Univers font.

- **7.5.4.4 Confusion between characters.** If a label contains pairs of characters that might be confused, the characters should be made distinguishably different.
  - a. The lower case letter "l" should have a short extension at the bottom extending to the right.
  - b. The numeral "1" should have a short extension at the top extending to the left.
  - c. The numeral "0" should appear narrower than the letter "O" of a given font.

- **7.5.4.5 Borders.** Space should be provided between characters and words to prevent the label from appearing crowded or difficult to read. The minimum clearance around a character or word should be 1/2 character height or more. However, clearance around a character, a word, or a set of words should not make the label appear "lost" within a large expanse of background.

### 7.5.5 Wording and information

- **7.5.5.1 Wording.** The wording of labels should be brief and unambiguous but explanatory, using words that are familiar to the users and maintainers.
- **7.5.5.2 Simplicity.** Control and display labels shall convey verbal meaning in the most direct manner by using simple words and phrases. Abbreviations may be used if they are familiar to the users and maintainers, for example, psi and km.
- **7.5.5.3 Consistency.** Designations and terms used on labels shall be consistent with designations and terms in user documentation and parts catalogs.
- **7.5.5.4 Irrelevant information.** Trade names and other irrelevant information shall not appear on labels.
- **7.5.5.5 Relevant information.** Information critical to identification, such as type or model, should be provided on labels.
- **7.5.5.6 Pictorial symbols.** If pictorial symbols are used in place of or in addition to word labels, they shall be completely unambiguous in the expected visual operating environment, and they shall not be used on a control that may rotate and thus position the symbol so that it may be confusing. Pictorial symbols shall be approved by the acquisition program office.

## 7.6 Accommodating people with disabilities

The "Americans with Disabilities Act of 1990" (Public Law 101-336) prohibits employment discrimination against qualified individuals with disabilities. If a person's disability creates a barrier to employment, the Act requires that the employer consider whether reasonable accommodations could remove the barrier. The intent of the Act is to permit people with disabilities to compete with people without disabilities on the basis of the same performance standards and requirements once such accommodations have been made.

In general, there is no clear division between people with and without disabilities; rather any single ability tends to be distributed as a continuous function, and any individual may be at the high end of the distribution for some abilities and at the low end for others. Still, there is a large and growing number of people with disabilities or functional limitations. One estimate is that between ten and twenty percent of the United States

population have significant disabilities. Indeed, almost everyone will experience functional limitations sufficient to make the operation of equipment or systems difficult if not impossible at some time during their lives.

Disabilities are not necessarily inborn or permanent. They may be temporary consequences of injury or illness, and they may be determined by the immediate environment. For example, a person might not be able to see a control or display because of darkness or might not be able to hear an auditory signal because of noise.

**Definitions.** An **impairment** is a loss or abnormality of physiological or anatomical structure or function. A **disability** is a physical or mental impairment that substantially limits one or more of a person's major life activities. A **person with a disability** is a person who has a disability, has a record of a disability, or is regarded as having a disability. A **qualified person with a disability** is a person who meets legitimate skill, experience, education, or other requirements of an employment position that he or she holds or seeks, and who can perform the essential functions of the position with a reasonable accommodation, if necessary. A **reasonable accommodation** is any modification or adjustment to a job or the work environment that will enable a qualified person with a disability to participate in the application process and to perform essential job functions. It may include: (1) making existing facilities readily accessible to and usable by people with disabilities, (2) restructuring jobs, (3) providing part-time or modified work schedules, (4) acquiring or modifying equipment or devices, (5) adjusting or modifying examinations, training materials, or policies, (6) providing qualified readers or interpreters, and (7) other similar accommodations.

In many cases, there are simple and low-cost (or even no cost) adaptations to equipment and systems that can significantly increase their accessibility and usefulness to people with disabilities. The most economical approach appears to be to design equipment and systems so that they are accessible to as many people as possible or practical. This is most easily accomplished when accessibility is considered during the design of the equipment or system.

A word of caution is in order: initial attempts at accessibility are sometimes made piecemeal; that is, features are made accessible rather than the equipment or system as a whole. For example, one feature might be made accessible to people with visual disabilities, and another feature to people with hearing disabilities, with the result that the equipment or system is not fully usable by either group. In most cases, it is possible, with careful design, to create equipment or systems that are simultaneously accessible to people with different types of disability. In any case, care must be taken to ensure that all the

functions of the equipment or system are accessible to the desired populations of users.

Anything that is done to make equipment or systems more accessible is likely to be of benefit to all users, not just those with disabilities. For example, dips in curbs at pedestrian crossings of roadways were originally intended to accommodate people in wheelchairs, but they have also been of benefit to people with baby carriages, strollers, shopping carts, bicyclists, and pedestrians in general.

### 7.6.1 Physical manipulations for people with disabilities

- **7.6.1.1 Inserting and removing objects.** Equipment intended to be accessible should be designed to maximize the number of people who can physically insert and remove objects required in its operation, for example, keys or computer diskettes. The equipment and objects should be resistant to damage from unsuccessful attempts.

**Discussion.** People who have physical disabilities may have difficulty inserting and removing objects required in the operation of some devices. Examples of such objects include computer diskettes, compact discs, cassette tapes, and keys.

Possible solutions that facilitate orientation and insertion include:

- a. ensure that minimal reach and dexterity are required to insert and remove objects,
- b. provide a simple funneling system or other self-guiding and orienting mechanism to position an object properly for insertion,
- c. allow a user to reposition a receptacle,
- d. if possible, allow the object to be inserted in any of several orientations, for example, keys might be insertable with either edge up,
- e. provide visual contrast between the insertion point and the rest of the device, and
- f. indicate both visually and tactually the proper orientation of the object.

Possible solutions that facilitate removal include:

- a. if applicable, eject objects far enough to permit easy gripping and removal, and

- b. provide automatic or push-button ejection.

Possible solutions that facilitate handling include:

- a. make objects to be inserted rugged and able to withstand rough handling, and
  - b. provide high friction surfaces on the objects.
- **7.6.1.2 Opening doors and drawers.** Equipment intended to be accessible should be designed to maximize the number of people who can open such things as doors, drawers, and sliding shelves.

**Discussion.** People who have severe physical disabilities may have difficulty opening or may not be able to open such things as doors, drawers, and sliding shelves. Possible solutions include:

- a. provide doors with open handles or levers, or doors that open in response to a push,
  - b. avoid the use of knobs or lips to open objects,
  - c. avoid dual latches that must be operated simultaneously,
  - d. use latches that can be operated with a closed fist,
  - e. mount heavy drawers and other objects on bearings,
  - f. provide electric pushbuttons or remote control power openers, and
  - g. minimize the need to bend the wrist or body.
- **7.6.1.3 Moving, removing, and replacing parts.** Equipment intended to be accessible should be designed to maximize the number of people who can reposition, remove, and replace frequently used detachable parts, such as covers and lids.

**Discussion.** Possible solutions include:

- a. mount covers and lids on slides or hinges,
- b. provide electronic operation of covers and lids,
- c. attach removable parts to the equipment with cord or wire,
- d. require only minimal force to operate movable and removable parts, and
- e. eliminate or minimize the need for users to assemble, install, and maintain parts.



- **7.6.1.4 Understanding manipulations.** Equipment intended to be accessible to people who have cognitive disabilities should be designed to maximize the number of people who can understand how to carry out the manipulations required to use the equipment.

**Discussion.** People who have cognitive disabilities may have difficulty remembering how to operate equipment, perform a series of tasks in the correct order or within the allotted time, obtain required measurements, or solve problems.

Possible solutions include:

- a. keep manipulations as simple as possible,
- b. provide cues or prompts for actions,
- c. write instructions directly on the device,
- d. provide an easy way out of any situation,
- e. eliminate timed responses or make the timing adjustable, and
- f. hide controls that are used infrequently.

## 7.6.2 Displays for people with disabilities

- **7.6.2.1 Hearing auditory outputs.** Equipment intended to be accessible to people with hearing disabilities should be designed to maximize the number of people who can hear auditory outputs (see also paragraph 8.10.6.1.2).

**Discussion.** Auditory information, such as synthesized speech, beeps, buzzers, tones, and machine noises, may not be heard well enough to elicit the intended response.

Possible solutions include:

- a. provide a volume adjustment,
- b. make auditory output as loud as practical,
- c. use sounds that have strong middle and low-frequency components (500–3000 Hz),
- d. provide a headphone jack so that a person with hearing disabilities can listen at high volume,
- e. provide a separate volume control for headphone jacks,

- f. place a sound source on the front of a device and away from sources of loud noise,
  - g. include in the equipment a built-in inductive coil to facilitate the direct use of the telecoil in hearing aids,
  - h. reduce the amount of nonmeaningful sound produced by equipment, and
  - i. present auditory information continuously or repetitively until the user responds to it.
- **7.6.2.2 Ensuring that auditory outputs are not missed.** Equipment intended to be accessible should be designed to minimize the number of people who will miss important auditory information.

**Discussion.** Auditory information, such as synthesized speech, beeps, buzzers, and tones, may not be heard at all by some users.

Possible solutions include:

- a. provide (or make available) all important information in visual form as well as auditory,
- b. provide a tactile indication of auditory information,
- c. facilitate the connection and use of tactile aids, and
- d. provide an optional remote audio, visual, or tactile indicator.

**Exception.** Equipment designed solely for the purpose of providing auditory output, for example, radios and CD players, will not generally be useful to people having severe hearing disabilities; this guideline is not intended to apply to those products.

- **7.6.2.3 Location of visual outputs.** Equipment intended to be accessible should be located to maximize the number of people who will be able to see visual outputs.

**Discussion.** Visual displays may not be readable because of their location.

Possible solutions include:

- a. place visual displays so that they are readable from varying heights, including a wheelchair,
- b. provide a means for adjusting the viewing angle of visual displays, and

- c. provide redundant auditory output in addition to a visual display if the visual display cannot be made physically accessible to a person in a wheelchair.
- **7.6.2.4 Reaching printed outputs.** Equipment intended to be accessible should be designed to maximize the number of people who will be able to reach printed output.

**Discussion.** Printouts may not be readable because of their location.

Possible solutions include:

- a. place printed output within easy reach of a person in a wheelchair, and
  - b. facilitate the manipulation of printouts with reaching and grasping aids, such as reachers, artificial hands or hooks, and mouthsticks with clasps attached.
- **7.6.2.5 Perceiving visual displays.** Equipment intended to be accessible should be designed to maximize the number of people who can perceive visual displays.

**Discussion.** Visual displays, for example, information presented on screens, paper printouts, warning lights, and dials, may not be seen well enough to elicit the intended response.

Possible solutions include:

- a. make letters and symbols as large as possible or practical,
  - b. provide users the capability of adjusting the size of the displayed image,
  - c. provide users the capability of attaching larger-image displays or other special assistive devices,
  - d. keep letters and symbols as simple as possible,
  - e. replace or supplement color coding with shape or position coding,
  - f. provide users the capability of adjusting contrast and brightness, and
  - g. provide users the capability of adjusting the speed of dynamic displays.
- **7.6.2.6 Ensuring that visual outputs are not missed.** Equipment intended to be accessible should be designed to minimize the number of people who will miss important information they cannot see.

**Discussion.** Visual output, for example, information presented on screens, paper printouts, warning lights, and dials, may not be seen at all by some users.

Possible solutions include:

- a. provide all important visual information redundantly in audible or tactile form or both,
- b. accompany visual cues and warnings with an auditory signal, one component of which is of middle to low frequency, that is, between 500 and 3000 Hz, and
- c. provide a connection point to which a special assistive device can be connected, for example, a voice synthesizer or a braille printer (this connection might be a standard parallel or serial port).

**Exception.** Equipment designed solely for the purpose of providing visual output, for example, slide projectors and cameras, will not generally be useful to people with severe visual disabilities; this guideline is not intended to apply to those products.

- **7.6.2.7 Understanding visual and auditory outputs.** Equipment intended to be accessible to people with cognitive disabilities should be designed to maximize the number of people who can understand the output.

**Discussion.** Visual and auditory output may be confusing or hard to understand.

Possible solutions include:

- a. provide simple screen layouts,
- b. provide users the capability of looking at one thing at a time,
- c. keep menus short,
- d. hide seldom-used commands and information,
- e. keep language as simple as possible,
- f. accompany words with pictures or icons,
- g. highlight the most important information,
- h. place the most important information at the beginning of written text,
- i. provide an attention-getting sound or words before an audio presentation,

- j. keep auditory presentations short,
  - k. provide automatic or user-activated repetition of auditory messages, and
  - l. present information in as many redundant forms as possible or practical, or provide as many display options as possible or practical.
- **7.6.2.8 Avoiding flashing-induced seizures.** Equipment intended to be accessible should be designed to maximize the number of people who can view an output display without experiencing a seizure (see also paragraph 8.10.7.1).

**Discussion.** People who are sensitive to seizures may have seizures induced by flashing screen cursors or by flickering displays. One solution is to ensure that the flash or display refresh rate is as far above or below 15-20 Hz as possible or practical.

### 7.6.3 Controls for people with disabilities

- **7.6.3.1 Manipulating controls.** Equipment intended to be accessible should be designed to maximize the number of people who can physically operate controls and other input mechanisms.

**Discussion.** People who may be unable to operate controls or who can operate them only with difficulty include people with severe weakness, people with missing limbs or digits, people with poor coordination or impaired muscular control, and people with limited movement control.

Possible solutions include:

- a. minimize the amount of force required to operate a control (see paragraph 7.6.3.3), or provide a means for adjusting the required force,
- b. provide ample space between controls (see paragraph 7.6.3.4),
- c. minimize or provide alternatives to requiring continuous action, such as holding a button down (see paragraph 7.6.3.5),
- d. avoid or provide alternatives to requiring simultaneous actions, such as holding down a control key while pressing another key (see paragraph 7.6.3.6),
- e. provide for operation with either hand,

- f. use concave or nonslip button tops, and provide a ridge around flat buttons,
  - g. if a unit of equipment requires a quick response (for example, a reaction time of less than 5 sec or release of a key or button in less than 1.5. sec), provide users the capability of adjusting the time interval or provide a nontime-dependent alternate input method,
  - h. if a unit of equipment requires fine motor control, provide an alternate mechanism that does not require fine motor control (for example, provide keyboard actions as an alternative way to achieve mouse actions),
  - i. avoid controls that require twisting or complex motions (for example, push and turn), and
  - j. provide optional redundant voice control.
- **7.6.3.2 Maximum force requirements.** The force required to operate a control intended to be accessible to people having extreme weakness or painful movement, for example, people having muscular dystrophy or arthritis, shall not exceed the appropriate value for turning, pinching, gripping, or pushing given in exhibit 7.6.3.2.

**Exhibit 7.6.3.2** Maximum force requirements for people with arthritis or muscular dystrophy

Type of force	For people with:	
	Arthritis	Muscular dystrophy
Turning (Nm)	45	72
Pinching (N)	54	67
Gripping (N)	52	21
Pushing (N)	43	48

- **7.6.3.3 Minimize force requirements.** The amount of force required to operate controls should be kept as low as possible.
- **7.6.3.4 Unobstructed access.** There should be no obstructions in the immediate vicinity of a control that might impede a user's ability to make contact with the control. Similarly, a control should not be recessed or otherwise "smoothed away" in a way that would make it difficult for a user to make contact with it.
- **7.6.3.5 Momentary, not continuous, operation.** A user should not be required to hold a control down for a period of time (see also paragraphs 8.10.2.2 and 8.10.2.8).

**Exception.** If safety considerations dictate the use of a "dead man's" switch or handle, this guideline does not apply.

- **7.6.3.6 One manipulation at a time.** A user should not be required to make two manipulations at the same time, for example, a user should not have to push and rotate a control simultaneously.

**Discussion.** Pushing is preferable to rotating or pulling.

- **7.6.3.7 Unconstrained manipulation.** The shape of a control should not unduly constrain the ways in which users can grip it; rather, the shape should allow users a great degree of freedom for manipulation. For example, a control should not be designed for operation only with the fingers; rather it should be possible to manipulate it with the full hand or even with both hands.
- **7.6.3.8 Connecting special alternative input and control devices.** Equipment intended to be accessible should be designed to maximize the number of people who can connect special alternative input and control devices.

**Discussion.** Possible solutions include:

- a. provide a standard infrared remote control, and
  - b. provide a standard connection point for special alternative input devices.
- **7.6.3.9 Reaching controls.** Equipment intended to be accessible should be designed to maximize the number of people who can reach the controls.

**Discussion.** People who use wheelchairs and people who have short limbs may have difficulty reaching controls. People who have poor motor control and people who are weak may have difficulty holding a position long enough to manipulate a control.

Possible solutions include:

- a. place controls, including keyboards, so that they are within easy reach of short people and people in wheelchairs,
- b. place controls so that a user can reach and use them with a minimal change in body position,
- c. place controls that must be used frequently in the most easily reached positions and where there is wrist or arm support,

- d. provide users the option of using speech input to operate a control, and
  - e. provide remote controls.
- **7.6.3.10 Finding controls.** Equipment intended to be accessible should be designed to maximize the number of people who can find and identify individual controls if they cannot see them.

**Discussion.** People who have visual disabilities may be unable to find and identify controls.

Possible solutions include:

- a. vary the size, shape, and texture of controls to facilitate their being found and identified,
  - b. provide controls whose shapes are associated with their functions,
  - c. provide sufficient space between controls for easy tactile location and identification and labeling with large print or braille,
  - d. place controls adjacent to the objects they control,
  - e. arrange controls in a way that is logical and easy to understand,
  - f. provide a raised lip or ridge around flat (membrane or glass) buttons, and
  - g. provide a redundant speech recognition input option.
- **7.6.3.11 Reading control labels.** Equipment intended to be accessible should be designed to maximize the number of people who can read the labels on controls.

**Discussion.** Labels may be difficult to read because of their size, color, or location.

Possible solutions include:

- a. make the lettering of labels as large as possible or practical,
- b. place labels so that they can be read by short people and people in wheelchairs,
- c. use raised lettering, and supplement it with braille,
- d. avoid the use of blue, green, and violet to encode information,



- e. provide easily interchangeable keycaps to permit replacement with special or optional keycaps,
  - f. arrange controls in groups that facilitate tactile identification, and
  - g. provide speech output that announces the names of keys or buttons when they are pressed.
- **7.6.3.12 Understanding control operation.** Equipment intended to be accessible should be designed to maximize the number of people who can understand how to operate controls and other input mechanisms.

**Discussion.** People who have cognitive or language disabilities, who are illiterate, or for whom English is a second language may have difficulty understanding the arrangement, labeling, or method of operation of controls and other input mechanisms.

Possible solutions include:

- a. reduce the number of controls,
  - b. simplify the controls,
  - c. make labels easy to understand,
  - d. reduce, eliminate, or provide cues for sequences of operations, and
  - e. build on the user's experiences.
- **7.6.3.13 Determining control status.** Equipment intended to be accessible should be designed to maximize the number of people who can determine the status or setting of controls they cannot see.

**Discussion.** People who have visual disabilities may not be able to see the status or setting of a control.

Possible solutions include:

- a. provide multi-sensory indications of divisions, positions, and levels of control settings, for example, detents, clicks, and raised lines,
- b. use knobs that have pointers rather than round, unmarked knobs,
- c. use moving pointers and stationary scales,

- d. provide multi-sensory indications of control status, for example, an audible tone in addition to a status light, and
- e. provide speech output to read or confirm a setting.

#### 7.6.4 Telecommunications for people with disabilities

- **7.6.4.1 Telecommunications capabilities for people with hearing disabilities.** People with hearing disabilities shall be able to transmit and receive messages in a telecommunications system in a form compatible with their disabilities and having a content comparable to messages transmitted and received by users who do not have hearing disabilities.

#### 7.6.5 Safety for people with disabilities

- **7.6.5.1 Avoiding injury.** Equipment intended to be accessible should be designed to maximize the number of people who can use the equipment without injury due to unperceived hazards or the user's lack of motor control.

**Discussion.** Possible solutions include:

- a. eliminate or provide audible warnings for hazards that otherwise rely on a user's visual ability to avoid,
  - b. make all surfaces, corners, protrusions, and device entrances free of sharp edges or extreme heat,
  - c. debur any internal parts accessible by a body part, even if contact with a body part is not normally expected,
  - d. provide automatic shutoff for devices that would present a hazard if left on, and
  - e. ensure that devices have stable, nonslip bases, or the ability to be attached to a stable surface.
- **7.6.5.2 Hazard warnings.** Equipment intended to be accessible should be designed to maximize the number of people who can perceive hazard warnings.

**Discussion.** People who have disabilities may not perceive warnings because they are insensitive to the modality in which the warning is presented or because they do not understand the warning.

Possible solutions include:

- a. use a broad frequency spectrum for audible warnings that includes at least two frequencies between 500 and 3000 Hz,
- b. use redundant visual and auditory signals for alarms,
- c. avoid or reduce glare on surfaces that contain warning messages,
- d. accompany warning messages with common color-coding conventions and symbols as appropriate, and
- e. provide people with severe hearing disabilities an optional, portable, vibrating device.

## Section 8 contents

<b>8 Human-computer interfaces</b> .....	<b>8-1</b>
<b>8.1 User-computer interaction</b> .....	<b>8-1</b>
<b>8.1.1 General</b> .....	<b>8-1</b>
□ 8.1.1.1 When to use .....	8-1
□ 8.1.1.2 System matched to user abilities .....	8-1
□ 8.1.1.3 User control .....	8-1
■ 8.1.1.4 User control of pace .....	8-2
■ 8.1.1.5 Explicit user control .....	8-2
■ 8.1.1.6 Simplicity .....	8-2
□ 8.1.1.7 Minimal user actions .....	8-2
□ 8.1.1.8 No repetitive entry of information .....	8-2
□ 8.1.1.9 User perspective .....	8-2
■ 8.1.1.10 Transaction wording .....	8-2
□ 8.1.1.11 User expectations .....	8-2
□ 8.1.1.12 Minimal memory load .....	8-2
□ 8.1.1.13 Customized interaction .....	8-2
■ 8.1.1.14 Multiple users .....	8-3
■ 8.1.1.15 Paging and scrolling .....	8-3
□ 8.1.1.16 Upper-lower case equivalence .....	8-3
□ 8.1.1.17 Canceling or undoing actions .....	8-3
□ 8.1.1.18 Names of control functions .....	8-3
□ 8.1.1.19 Closure .....	8-3
□ 8.1.1.20 Interactive paradigm .....	8-3
□ 8.1.1.21 User control .....	8-3
□ 8.1.1.22 Immediate feedback .....	8-3
□ 8.1.1.23 Visual cues .....	8-4
□ 8.1.1.24 Prompts .....	8-4
□ 8.1.1.25 Ignoring user actions .....	8-4
□ 8.1.1.26 Error detection .....	8-4
■ 8.1.1.27 Confirmed destruction .....	8-4
<b>8.1.2 System response time</b> .....	<b>8-4</b>
■ 8.1.2.1 Appropriate system response time .....	8-4
■ 8.1.2.2 Maximum system response times .....	8-4
<b>Exhibit 8.1.2.2</b> Maximum system response times for routine system tasks .....	8-5
■ 8.1.2.3 Variability of system response time .....	8- 5

■ 8.1.2.4 Acknowledgement of delayed processing .....	8-5
■ 8.1.2.5 Notification of display completion .....	8-6
□ 8.1.2.6 Response-time-induced keyboard lockout .....	8-6
■ 8.1.2.7 Lockout duration .....	8-6
■ 8.1.2.8 Lockout indication .....	8-6
□ 8.1.2.9 Lockout override .....	8-6
<b>8.1.3 System-initiated information .....</b>	<b>8-6</b>
<b>8.1.3.1 Prompting .....</b>	<b>8-6</b>
■ 8.1.3.1.1 Prompting .....	8-6
■ 8.1.3.1.2 Prompt contents .....	8-6
■ 8.1.3.1.3 Location of prompts .....	8-6
□ 8.1.3.1.4 Duration of prompts .....	8-6
□ 8.1.3.1.5 User-selected level of prompting detail .....	8-7
<b>8.1.3.2 Feedback .....</b>	<b>8-7</b>
■ 8.1.3.2.1 Entry acknowledgement .....	8-7
■ 8.1.3.2.2 Periodic feedback .....	8-7
□ 8.1.3.2.3 Periodic feedback messages .....	8-7
■ 8.1.3.2.4 Completion of processing .....	8-7
<b>8.1.3.3 System-initiated interrupts .....</b>	<b>8-7</b>
■ 8.1.3.3.1 System interrupts .....	8-7
■ 8.1.3.3.2 "Working" indication .....	8-7
<b>8.1.3.4 Light pen .....</b>	<b>8-8</b>
□ 8.1.3.4.1 Availability of status information .....	8-8
□ 8.1.3.4.2 Status of alarm settings .....	8-8
□ 8.1.3.4.3 Status of other systems or users .....	8-8
<b>8.1.3.5 Alarms .....</b>	<b>8-8</b>
■ 8.1.3.5.1 Distinctive and consistent alarms .....	8-8
■ 8.1.3.5.2 Acknowledging and terminating alarms .....	8-8
■ 8.1.3.5.3 Feedback about alarms and alerts .....	8-8
■ 8.1.3.5.4 Special acknowledgement of critical alarms .....	8-8
■ 8.1.3.5.5 Alarm reset .....	8-8
□ 8.1.3.5.6 User setting of alarm parameters .....	8-9
<b>8.1.3.6 Routine messages .....</b>	<b>8-9</b>
■ 8.1.3.6.1 Routine feedback .....	8-9
□ 8.1.3.6.2 User control .....	8-9
□ 8.1.3.6.3 Clarity of purpose .....	8-9
<b>8.1.4 User-initiated interrupts .....</b>	<b>8-9</b>
■ 8.1.4.1 User interruption of transactions .....	8-9
■ 8.1.4.2 Stored or entered data .....	8-9

▪ 8.1.4.3 Backup (or Go-back) .....	8-9
□ 8.1.4.4 Cancel (or Undo) .....	8-9
▪ 8.1.4.5 End, Exit, or Stop .....	8-9
▪ 8.1.4.6 Pause and Continue .....	8-9
▪ 8.1.4.7 Indicating Pause status .....	8-10
▪ 8.1.4.8 Restart (or Revert) .....	8-10
▪ 8.1.4.9 Review .....	8-10
▪ 8.1.4.10 Suspend .....	8-10
▪ 8.1.4.11 Indicating Suspended status .....	8-10
<b>8.1.5 Error management .....</b>	<b>8-10</b>
<b>8.1.5.1 General .....</b>	<b>8-10</b>
□ 8.1.5.1.1 User-detected errors .....	8-10
▪ 8.1.5.1.2 Appropriate response to all entries .....	8-10
□ 8.1.5.1.3 System detection of error type .....	8-10
□ 8.1.5.1.4 Fast error detection .....	8-11
▪ 8.1.5.1.5 Immediate data correction .....	8-11
□ 8.1.5.1.6 Prompting command correction .....	8-11
□ 8.1.5.1.7 Display duration .....	8-11
▪ 8.1.5.1.8 Enter action for corrections .....	8-11
▪ 8.1.5.1.9 Return to main interaction .....	8-11
▪ 8.1.5.1.10 User confirmation of destructive actions .....	8-11
▪ 8.1.5.1.11 Flexible "go back" for error correction .....	8-11
▪ 8.1.5.1.12 Undo control action .....	8-11
▪ 8.1.5.1.13 Error recovery .....	8-11
<b>8.1.5.2 Error messages .....</b>	<b>8-11</b>
□ 8.1.5.2.1 System-detected need for help .....	8-11
▪ 8.1.5.2.2 Confirmation messages .....	8-12
▪ 8.1.5.2.3 Multilevel messages .....	8-12
□ 8.1.5.2.4 Multiple errors .....	8-12
□ 8.1.5.2.5 Nondisruptive error messages .....	8-12
▪ 8.1.5.2.6 Coding of warning messages .....	8-12
□ 8.1.5.2.7 Content of error messages .....	8-12
▪ 8.1.5.2.8 Wording of error messages .....	8-12
□ 8.1.5.2.9 Tone of error messages .....	8-12
□ 8.1.5.2.10 Correcting errors .....	8-12
▪ 8.1.5.2.11 Cursor placement .....	8-12
▪ 8.1.5.2.12 Instructions and error messages .....	8-13
<b>8.1.5.3 Command interaction errors .....</b>	<b>8-13</b>
▪ 8.1.5.3.1 Command editing .....	8-13
▪ 8.1.5.3.2 Command correction prompting .....	8-13
□ 8.1.5.3.3 Unrecognized commands .....	8-13
▪ 8.1.5.3.4 Errors in stacked commands .....	8-13
▪ 8.1.5.3.5 Partial execution of stacked commands .....	8-13
▪ 8.1.5.3.6 Stacked command execution .....	8-13

<b>8.1.6 Transaction and control options</b>	.....	<b>8-13</b>
▪ 8.1.6.1 User-specified transaction timing	.....	8-13
▪ 8.1.6.2 User memory load	.....	8-14
▪ 8.1.6.3 Prompting control entries	.....	8-14
▪ 8.1.6.4 List of basic control options	.....	8-14
□ 8.1.6.5 Appropriate specific options	.....	8-14
□ 8.1.6.6 Option wording	.....	8-14
□ 8.1.6.7 Option presentation	.....	8-14
▪ 8.1.6.8 Option code display	.....	8-14
▪ 8.1.6.9 Displaying control defaults	.....	8-14
▪ 8.1.6.10 Initial cursor position for pointing devices	.....	8-14
▪ 8.1.6.11 Initial cursor position for keyboards	.....	8-14
▪ 8.1.6.12 Consistent Continue option	.....	8-15
□ 8.1.6.13 Options at completion of a transaction	.....	8-15
□ 8.1.6.14 Command stacking	.....	8-15
▪ 8.1.6.15 Punctuation of stacked commands	.....	8-15
□ 8.1.6.16 User-defined stacks (macros)	.....	8-15
<b>8.1.7 Abbreviations</b>	.....	<b>8-15</b>
▪ 8.1.7.1 Abbreviations	.....	8-15
▪ 8.1.7.2 Use of abbreviations	.....	8-15
▪ 8.1.7.3 Definitions of abbreviations	.....	8-16
▪ 8.1.7.4 New abbreviations	.....	8-16
<b>8.1.8 Interaction method</b>	.....	<b>8-16</b>
▪ 8.1.8.1 Selection of interaction type	.....	8-16
<b>Exhibit 8.1.8.1</b> Appropriateness of interaction types for various task requirements, system characteristics, and user abilities	.....	8-17
▪ 8.1.8.2 Distinctive display of control information	.....	8-18
▪ 8.1.8.3 Hierarchical levels	.....	8-18
<b>8.1.9 Question-answer</b>	.....	<b>8-19</b>
▪ 8.1.9.1 Singular presentation of questions	.....	8-19
□ 8.1.9.2 Display of interrelated answers	.....	8-19
▪ 8.1.9.3 Sequence compatibility	.....	8-19
<b>8.1.10 Form-filling</b>	.....	<b>8-19</b>
▪ 8.1.10.1 Consistency	.....	8-19
▪ 8.1.10.2 Default entries	.....	8-19
▪ 8.1.10.3 Default listing	.....	8-19
▪ 8.1.10.4 Other applicable sections	.....	8-19

<b>8.1.11 Menus and menu selection</b>	.....	<b>8-19</b>
<b>8.1.11.1 General</b>	.....	<b>8-20</b>
▪ 8.1.11.1.1 Menu titles	.....	8-20
▪ 8.1.11.1.2 Consistent style	.....	8-20
▪ 8.1.11.1.3 Consistent wording and ordering	.....	8-20
▪ 8.1.11.1.4 Consistent with command language	.....	8-20
□ 8.1.11.1.5 Response time and display rate vs. menu length	...	8-20
□ 8.1.11.1.6 Number of options	.....	8-20
▪ 8.1.11.1.7 Display of all options	.....	8-20
▪ 8.1.11.1.8 Distinguishing unavailable options	.....	8-20
▪ 8.1.11.1.9 Distinguishing types of options	.....	8-20
▪ 8.1.11.1.10 Instructions	.....	8-21
□ 8.1.11.1.11 Shortcuts for experienced users	.....	8-21
▪ 8.1.11.1.12 Stacking menu selections	.....	8-21
▪ 8.1.11.1.13 Menus distinct from other displayed information	.....	8-21
<b>8.1.11.2 Menu formatting</b>	.....	<b>8-21</b>
□ 8.1.11.2.1 Presentation of options	.....	8-21
▪ 8.1.11.2.2 Consistent menus and options	.....	8-21
▪ 8.1.11.2.3 Logical grouping of menu options	.....	8-21
▪ 8.1.11.2.4 Ordering groups of options	.....	8-21
▪ 8.1.11.2.5 Ordering options within a menu or group	.....	8-21
□ 8.1.11.2.6 Numbering menu options	.....	8-22
▪ 8.1.11.2.7 Distinguishing unavailable options	.....	8-22
<b>8.1.11.3 Hierarchical menus</b>	.....	<b>8-22</b>
□ 8.1.11.3.1 When to use	.....	8-22
□ 8.1.11.3.2 Organizing and labeling hierarchical menus	.....	8-22
▪ 8.1.11.3.3 Consistent design and use	.....	8-22
□ 8.1.11.3.4 Minimum number of levels	.....	8-22
□ 8.1.11.3.5 Easy selection of important options	.....	8-22
▪ 8.1.11.3.6 Indicating current position in menu structure	.....	8-22
□ 8.1.11.3.7 Hierarchical menus in graphical user interfaces	.....	8-22
▪ 8.1.11.3.8 Top level menu	.....	8-23
▪ 8.1.11.3.9 Organization of a system-level menu	.....	8-23
▪ 8.1.11.3.10 Return to system-level menu	.....	8-23
▪ 8.1.11.3.11 Return to next higher level	.....	8-23
□ 8.1.11.3.12 Lower level menus	.....	8-23
□ 8.1.11.3.13 Bypassing menu selections	.....	8-23
□ 8.1.11.3.14 Software navigation aids	.....	8-23
<b>8.1.11.4 Menu bars</b>	.....	<b>8-23</b>
□ 8.1.11.4.1 When to use	.....	8-23
□ 8.1.11.4.2 Visibility of menu bar options	.....	8-23



<b>8.1.11.5 Pull-down menus</b>	.....	<b>8-23</b>
□ 8.1.11.5.1 When to use	.....	8-23
■ 8.1.11.5.2 Consistent location	.....	8-24
<b>8.1.11.6 Pop-up menus</b>	.....	<b>8-24</b>
□ 8.1.11.6.1 When to use	.....	8-24
□ 8.1.11.6.2 Pop-up menu location	.....	8-24
■ 8.1.11.6.3 Selecting an option using a pointing device	.....	8-24
<b>8.1.11.7 Pull-down menus</b>	.....	<b>8-24</b>
■ 8.1.11.7.1 Equivalence of input devices	.....	8-24
■ 8.1.11.7.2 Initial cursor position for pointing devices	.....	8-24
■ 8.1.11.7.3 Initial cursor position for keyboards	.....	8-25
■ 8.1.11.7.4 Feedback for menu selection	.....	8-25
□ 8.1.11.7.5 Abbreviated entries	.....	8-25
□ 8.1.11.7.6 Menu selection by pointing	.....	8-25
■ 8.1.11.7.7 Size of selectable area	.....	8-25
■ 8.1.11.7.8 Two-action activation	.....	8-25
□ 8.1.11.7.9 Number of selections per menu	.....	8-25
<b>8.1.11.8 Titles and wording of options</b>	.....	<b>8-25</b>
■ 8.1.11.8.1 Wording of options	.....	8-25
□ 8.1.11.8.2 Options as commands	.....	8-25
□ 8.1.11.8.3 Titles for groups of options	.....	8-26
■ 8.1.11.8.4 Appearance of group titles	.....	8-26
<b>8.1.11.9 Coding options</b>	.....	<b>8-26</b>
□ 8.1.11.9.1 Conveyed meaning of coding	.....	8-26
■ 8.1.11.9.2 Consistent coding	.....	8-26
□ 8.1.11.9.3 Letter vs. numeric codes	.....	8-26
■ 8.1.11.9.4 Numeric coding	.....	8-26
■ 8.1.11.9.5 Displaying option codes	.....	8-26
<b>8.1.12 Function keys</b>	.....	<b>8-26</b>
□ 8.1.12.1 Single function	.....	8-26
■ 8.1.12.2 Consistency within an application	.....	8-26
■ 8.1.12.3 Consistency across applications	.....	8-26
■ 8.1.12.4 Feedback	.....	8-27
□ 8.1.12.5 "Soft" function keys	.....	8-27
□ 8.1.12.6 "Soft" function key activation	.....	8-27
■ 8.1.12.7 Disabling of unused function keys	.....	8-27
■ 8.1.12.8 Easy return to base-level functions	.....	8-27
□ 8.1.12.9 User-defined functions (macros)	.....	8-27
■ 8.1.12.10 Single key operation for continuously-available functions	.....	8-27
■ 8.1.12.11 Frequently-used functions	.....	8-28
■ 8.1.12.12 Single key press	.....	8-28

□ 8.1.12.13 Relationship of functions assigned to the same key .....	8-28
□ 8.1.12.14 Relationship of sets of functions .....	8-28
■ 8.1.12.15 Labeling single-function keys .....	8-28
■ 8.1.12.16 Labeling multifunction keys .....	8-28
■ 8.1.12.17 Indicating status .....	8-28
□ 8.1.12.18 Labeling of menu items selectable with function keys .....	8-28
■ 8.1.12.19 Importance and frequency of use .....	8-28
■ 8.1.12.20 Safeguarding .....	8-29
<b>8.1.13 Command language design .....</b>	<b>8-29</b>
■ 8.1.13.1 Functional command language .....	8-29
■ 8.1.13.2 Consistent syntax .....	8-29
□ 8.1.13.3 Complexity of command language .....	8-29
■ 8.1.13.4 Layered command language .....	8-29
□ 8.1.13.5 Command stacking .....	8-29
■ 8.1.13.6 Command entry area .....	8-29
■ 8.1.13.7 Distinctive working of commands .....	8-29
■ 8.1.13.8 Consistent wording of commands .....	8-29
■ 8.1.13.9 Familiar wording .....	8-29
□ 8.1.13.10 Abbreviation of commands .....	8-30
□ 8.1.13.11 Selection of commands .....	8-30
□ 8.1.13.12 Alternate wording .....	8-30
□ 8.1.13.13 "Word" length .....	8-30
■ 8.1.13.14 Characters .....	8-30
■ 8.1.13.15 Punctuation .....	8-30
□ 8.1.13.16 Blank spaces .....	8-30
■ 8.1.13.17 Spelling errors .....	8-30
■ 8.1.13.18 Editing commands .....	8-30
■ 8.1.13.19 Execution .....	8-30
■ 8.1.13.20 Confirmation of a command .....	8-30
■ 8.1.13.21 Unrecognized commands .....	8-30
<b>8.1.14 Query and natural language .....</b>	<b>8-31</b>
<b>8.1.14.1 General .....</b>	<b>8-31</b>
□ 8.1.14.1.1 Ease of use .....	8-31
□ 8.1.14.1.2 Interactive .....	8-31
■ 8.1.14.1.3 Natural organization of data .....	8-31
■ 8.1.14.1.4 Task-oriented queries .....	8-31
□ 8.1.14.1.5 User assistance .....	8-31
■ 8.1.14.1.6 Large-scale retrieval confirmation .....	8-31
□ 8.1.14.1.7 Logical combination queries .....	8-31
□ 8.1.14.1.8 Subsequent queries .....	8-31
■ 8.1.14.1.9 Flexible queries .....	8-31
□ 8.1.14.1.10 Error detection and correction .....	8-32
□ 8.1.14.1.11 Formats matched to user needs .....	8-32
□ 8.1.14.1.12 User preferences .....	8-32

<b>8.1.14.2 Query screen design</b>	.....	<b>8-32</b>
■ 8.1.14.2.1 Applicable criteria and guidelines	.....	8-32
□ 8.1.14.2.2 Relevant information only	.....	8-32
□ 8.1.14.2.3 Frequently-used information	.....	8-32
<b>8.1.14.3 User requirements</b>	.....	<b>8-32</b>
□ 8.1.14.3.1 Importance of search terms	.....	8-32
□ 8.1.14.3.2 Redisplay	.....	8-32
□ 8.1.14.3.3 Spelling and word variants	.....	8-32
□ 8.1.14.3.4 Punctuation	.....	8-32
□ 8.1.14.3.5 Word roots	.....	8-33
□ 8.1.14.3.6 Exceptions	.....	8-33
□ 8.1.14.3.7 Appearance of output	.....	8-33
□ 8.1.14.3.8 Assisting the user	.....	8-33
<b>8.1.14.4 Usability</b>	.....	<b>8-33</b>
□ 8.1.14.4.1 Commands	.....	8-33
□ 8.1.14.4.2 Minimal user effort	.....	8-33
■ 8.1.14.4.3 Messages	.....	8-33
□ 8.1.14.4.4 Ease-of-use features	.....	8-33
<b>8.1.14.5 Searching</b>	.....	<b>8-33</b>
□ 8.1.14.5.1 Searching operations	.....	8-33
□ 8.1.14.5.2 Control operations	.....	8-34
□ 8.1.14.5.3 Query formulation operations	.....	8-34
□ 8.1.14.5.4 Abbreviations	.....	8-34
□ 8.1.14.5.5 Search time feedback	.....	8-35
□ 8.1.14.5.6 Additional operations	.....	8-35
<b>8.1.14.6 Multiple levels</b>	.....	<b>8-35</b>
□ 8.1.14.6.1 Accommodating users differing in experience	.....	8-35
□ 8.1.14.6.2 Changing levels	.....	8-35
□ 8.1.14.6.3 Context-sensitive help	.....	8-36
□ 8.1.14.6.4 Novice level	.....	8-36
□ 8.1.14.6.5 Prompting novices	.....	8-36
□ 8.1.14.6.6 Commands for novices	.....	8-36
□ 8.1.14.6.7 Commands for experts	.....	8-36
<b>8.1.15 Graphical controls</b>	.....	<b>8-36</b>
<b>8.1.15.1 Icons</b>	.....	<b>8-36</b>
■ 8.1.15.1.1 Resolution	.....	8-36
■ 8.1.15.1.2 Description	.....	8-36
■ 8.1.15.1.3 Labels	.....	8-36
■ 8.1.15.1.4 Consistency	.....	8-36
□ 8.1.15.1.5 Uniqueness of icons	.....	8-36
□ 8.1.15.1.6 Icon design	.....	8-36
□ 8.1.15.1.7 Manipulation of icons	.....	8-37

■ 8.1.15.1.8 Icon menu .....	8-37
■ 8.1.15.1.9 Using the icon menu .....	8-37
■ 8.1.15.1.10 Restoring the window .....	8-37
■ 8.1.15.1.11 Location of icons .....	8-37
□ 8.1.15.1.12 User preferences .....	8-37
□ 8.1.15.1.13 Moving icons .....	8-37
<b>8.1.15.2 Push buttons</b> .....	<b>8-37</b>
□ 8.1.15.2.1 Consistent appearance .....	8-37
■ 8.1.15.2.2 Labels .....	8-37
■ 8.1.15.2.3 Consistent labels .....	8-38
□ 8.1.15.2.4 Text labels .....	8-38
□ 8.1.15.2.5 "Standard" actions .....	8-38
■ 8.1.15.2.6 Activating a push button .....	8-38
■ 8.1.15.2.7 Default push buttons .....	8-38
<b>Exhibit 8.1.15.2.7</b> Example of a default push button .....	8-38
<b>8.1.15.3 Radio buttons</b> .....	<b>8-38</b>
■ 8.1.15.3.1 When to use .....	8-38
<b>Exhibit 8.1.15.3.1</b> Two types of radio button sets .....	8-39
■ 8.1.15.3.2 Selecting a radio button .....	8-38
■ 8.1.15.3.3 Selected button highlighted .....	8-38
<b>8.1.15.4 Check boxes</b> .....	<b>8-39</b>
■ 8.1.15.4.1 When to use .....	8-39
■ 8.1.15.4.2 Selecting check boxes .....	8-39
<b>8.1.15.5 Sliders (scales)</b> .....	<b>8-39</b>
■ 8.1.15.5.1 Components of a slider .....	8-39
□ 8.1.15.5.2 Readout .....	8-39
■ 8.1.15.5.3 Slider operation .....	8-40
■ 8.1.15.5.4 Labeling sliders .....	8-40
<b>8.2 Basic screen design and operation</b> .....	<b>8-40</b>
<b>8.2.1 Principles, features, and functions</b> .....	<b>8-40</b>
<b>8.2.1.1 General principles</b> .....	<b>8-40</b>
□ 8.2.1.1.1 Simplicity .....	8-40
□ 8.2.1.1.2 Logical grouping .....	8-40

□ 8.2.1.1.3 Minimal movement .....	8-40
□ 8.2.1.1.4 What information to display .....	8-40
□ 8.2.1.1.5 Minimal information density .....	8-40
□ 8.2.1.1.6 Screen density .....	8-41
□ 8.2.1.1.7 Integrated information .....	8-41
■ 8.2.1.1.8 Directly usable form .....	8-41
<b>8.2.1.2 Consistency</b> .....	<b>8-41</b>
■ 8.2.1.2.1 Consistent screen structure .....	8-41
■ 8.2.1.2.2 Consistent screen elements .....	8-41
■ 8.2.1.2.3 Input prompts .....	8-41
■ 8.2.1.2.4 Instructions and error messages .....	8-41
<b>8.2.1.3 Context</b> .....	<b>8-41</b>
□ 8.2.1.3.1 Maintaining context .....	8-41
■ 8.2.1.3.2 Highlighting .....	8-41
■ 8.2.1.3.3 Display of context information .....	8-42
■ 8.2.1.3.4 Distinctive position and format .....	8-42
■ 8.2.1.3.5 Operational mode .....	8-42
□ 8.2.1.3.6 Current context indication .....	8-42
■ 8.2.1.3.7 Context-dependent actions .....	8-42
■ 8.2.1.3.8 Action history .....	8-42
■ 8.2.1.3.9 Control parameters display .....	8-42
<b>8.2.1.4 Format</b> .....	<b>8-42</b>
■ 8.2.1.4.1 Title .....	8-42
■ 8.2.1.4.2 Other reserved areas .....	8-42
■ 8.2.1.4.3 Layout of screen elements .....	8-43
□ 8.2.1.4.4 Minimal visual competition .....	8-43
□ 8.2.1.4.5 Arrangement of screen elements .....	8-43
□ 8.2.1.4.6 Location of displayed instructions .....	8-43
□ 8.2.1.4.7 Use of contrasting features .....	8-43
■ 8.2.1.4.8 Abbreviations .....	8-43
<b>8.2.1.5 Displaying text</b> .....	<b>8-43</b>
□ 8.2.1.5.1 Breaking up large blocks of text .....	8-43
□ 8.2.1.5.2 Lists .....	8-43
■ 8.2.1.5.3 Order of information .....	8-43
■ 8.2.1.5.4 Primary viewing area .....	8-43
<b>8.2.1.6 Scrolling and paging</b> .....	<b>8-44</b>
■ 8.2.1.6.1 Stationary text .....	8-44
■ 8.2.1.6.2 Paging .....	8-44
□ 8.2.1.6.3 Labeling pages .....	8-44
<b>8.2.1.7 Initial display</b> .....	<b>8-44</b>
■ 8.2.1.7.1 Initial display .....	8-44
■ 8.2.1.7.2 Starting point .....	8-44

<b>8.2.1.8 Matching controls to users</b>	.....	<b>8-44</b>
□ 8.2.1.8.1 Minimizing the user's short-term memory load	.....	8-44
□ 8.2.1.8.2 Selecting a mutually exclusive option	.....	8-44
□ 8.2.1.8.3 Selecting nonmutually exclusive options	.....	8-44
□ 8.2.1.8.4 Menus	.....	8-45
□ 8.2.1.8.5 Pop-up menus	.....	8-45
<b>8.2.1.9 Arranging information to match user actions</b>	.....	<b>8-45</b>
□ 8.2.1.9.1 Matching window layout to task	.....	8-45
□ 8.2.1.9.2 Matching window layout to users' "Natural" patterns	.....	8-45
□ 8.2.1.9.3 Minimal user effort	.....	8-45
<b>8.2.1.10 Arranging information by importance</b>	.....	<b>8-45</b>
□ 8.2.1.10.1 Location by importance	.....	8-45
□ 8.2.1.10.2 Task-critical information	.....	8-45
<b>8.2.1.11 Visual and audible coding</b>	.....	<b>8-45</b>
□ 8.2.1.11.1 Visual coding of critical information	.....	8-45
■ 8.2.1.11.2 Flash coding	.....	8-46
■ 8.2.1.11.3 Audible coding of critical information	.....	8-46
<b>8.2.1.12 Dynamic information in windows</b>	.....	<b>8-46</b>
□ 8.2.1.12.1 User control	.....	8-46
□ 8.2.1.12.2 Rate of updating	.....	8-46
□ 8.2.1.12.3 Dynamic information in frozen, inactive, and iconized windows	.....	8-46
<b>8.2.2 Operations</b>	.....	<b>8-46</b>
<b>8.2.2.1 General</b>	.....	<b>8-46</b>
□ 8.2.2.1.1 Screen saver	.....	8-46
<b>8.2.2.2 System log on and log off</b>	.....	<b>8-47</b>
□ 8.2.2.2.1 Log on screen	.....	8-47
■ 8.2.2.2.2 Log on prompts	.....	8-47
■ 8.2.2.2.3 Echoing of user's name, non-echoing of password	.....	8-47
■ 8.2.2.2.4 Error messages	.....	8-47
■ 8.2.2.2.5 Completion of log on	.....	8-47
■ 8.2.2.2.6 System log off	.....	8-47

■ 8.2.2.2.7 Prompting to exit an application or save entries .....	8-47
■ 8.2.2.2.8 Confirming a log off .....	8-47
■ 8.2.2.2.9 Completion of log off .....	8-47
<b>8.2.2.3 Application log on and log off .....</b>	<b>8-47</b>
■ 8.2.2.3.1 Log on .....	8-47
■ 8.2.2.3.2 Log off .....	8-47
■ 8.2.2.3.3 Confirming an exit .....	8-48
■ 8.2.2.3.4 Preserving unfinished work .....	8-48
■ 8.2.2.3.5 Completion of log off .....	8-48
<b>8.2.3 Characters and line length .....</b>	<b>8-48</b>
■ 8.2.3.1 Capitalization .....	8-48
■ 8.2.3.2 Capitalization of phrases for emphasis .....	8-48
□ 8.2.3.3 Spacing between characters .....	8-48
■ 8.2.3.4 Spacing between words .....	8-48
■ 8.2.3.5 Spacing between lines .....	8-48
■ 8.2.3.6 Spacing between paragraphs .....	8-49
□ 8.2.3.7 Minimum character height.....	8-49
■ 8.2.3.8 Character width .....	8-49
□ 8.2.3.9 Stroke width.....	8-49
□ 8.2.3.10 Minimum dot matrix .....	8-49
<b>8.2.4 Context .....</b>	<b>8-49</b>
<b>8.2.4.1 Color selection .....</b>	<b>8-50</b>
■ 8.2.4.1.1 General principles .....	8-50
□ 8.2.4.1.2 When to use color .....	8-50
□ 8.2.4.1.3 Constraints on the use of color .....	8-50
■ 8.2.4.1.4 Discrimination of colors .....	8-51
<b>Exhibit 8.2.4.1.4 Discriminable colors and their</b>	
wavelengths .....	8-51
□ 8.2.4.1.5 Colors for infrequently used information .....	8-51
□ 8.2.4.1.6 Colors for action and status.....	8-51
■ 8.2.4.1.7 Consistent use .....	8-51
□ 8.2.4.1.8 One meaning per color .....	8-51
■ 8.2.4.1.9 Consistent with conventions .....	8-51
□ 8.2.4.1.10 Number of colors to use .....	8-51
□ 8.2.4.1.11 Maximum number of colors .....	8-51
□ 8.2.4.1.12 Additional colors .....	8-51
□ 8.2.4.1.13 Adjacent colors .....	8-51
□ 8.2.4.1.14 Color and ambient illumination .....	8-52
□ 8.2.4.1.15 Color key .....	8-52
□ 8.2.4.1.16 Colors at the periphery of large screen displays .....	8-52
■ 8.2.4.1.17 Limiting user color settings .....	8-52
■ 8.2.4.1.18 Easy return to default color scheme .....	8-52
■ 8.2.4.1.19 Portable applications .....	8-52
■ 8.2.4.1.20 Text-background contrast .....	8-52

	<b>Exhibit 8.2.4.1.20</b> Luminance contrast ratios for various conditions .....	8-53
	<ul style="list-style-type: none"> <li>■ 8.2.4.1.21 Green, yellow, and red .....</li> <li>□ 8.2.4.1.22 Blue .....</li> <li>□ 8.2.4.1.23 Colors for comparison .....</li> <li>■ 8.2.4.1.24 Small areas .....</li> <li>■ 8.2.4.1.25 Highlighting .....</li> </ul>	8-53 8-53 8-53 8-53 8-53
<b>8.2.4.2</b>	<b>Tonal color coding</b> .....	<b>8-53</b>
	<ul style="list-style-type: none"> <li>□ 8.2.4.2.1 When to use .....</li> <li>□ 8.2.4.2.2 Ordered coding .....</li> </ul>	8-53 8-54
<b>8.2.4.3</b>	<b>Color-coded symbols</b> .....	<b>8-54</b>
	<ul style="list-style-type: none"> <li>■ 8.2.4.3.1 Code, symbol, not text .....</li> <li>■ 8.2.4.3.2 Symbol size .....</li> <li>■ 8.2.4.3.3 Symbol brightness .....</li> <li>■ 8.2.4.3.4 Refresh rate .....</li> </ul>	8-54 8-54 8-54 8-54
<b>8.3</b>	<b>Windowing</b> .....	<b>8-54</b>
<b>8.3.1</b>	<b>General</b> .....	<b>8-55</b>
	<ul style="list-style-type: none"> <li>■ 8.3.1.1 Hardware limitations on the use of windowing .....</li> <li>■ 8.3.1.2 User-specified windows .....</li> <li>■ 8.3.1.3 Number of allowable open windows .....</li> </ul>	8-55 8-55 8-55
<b>8.3.2</b>	<b>Window components and appearance</b> .....	<b>8-55</b>
<b>8.3.2.1</b>	<b>General</b> .....	<b>8-55</b>
	<ul style="list-style-type: none"> <li>■ 8.3.2.1.1 "Primary" windows .....</li> <li>■ 8.3.2.1.2 "Secondary" windows .....</li> <li>□ 8.3.2.1.3 Secondary window constraints .....</li> <li>■ 8.3.2.1.4 Window placement .....</li> </ul>	8-55 8-56 8-56 8-56
<b>8.3.2.2</b>	<b>Title bar</b> .....	<b>8-56</b>
	<ul style="list-style-type: none"> <li>■ 8.3.2.2.1 Description .....</li> </ul>	8-56
<b>8.3.2.3</b>	<b>Border</b> .....	<b>8-56</b>
	<ul style="list-style-type: none"> <li>■ 8.3.2.3.1 Description .....</li> </ul>	8-56
<b>8.3.2.4</b>	<b>Menu bar</b> .....	<b>8-56</b>
	<ul style="list-style-type: none"> <li>■ 8.3.2.4.1 Navigation to the menu bar .....</li> <li>■ 8.3.2.4.2 Navigation within a menu bar .....</li> </ul>	8-56 8-57



▪ 8.3.2.4.3	Selecting an option in a menu bar using its mnemonic .....	8-57
▪ 8.3.2.4.4	Leaving the menu bar .....	8-57
▪ 8.3.2.4.5	Displaying a pull-down menu .....	8-57
□ 8.3.2.4.6	Selecting the default option on a pull-down menu .....	8-57
<b>8.3.3</b>	<b>Window controls</b> .....	<b>8-57</b>
<b>8.3.3.1</b>	<b>General</b> .....	<b>8-57</b>
▪ 8.3.3.1.1	Consistent and distinctive .....	8-57
▪ 8.3.3.1.2	Distinct from other objects .....	8-58
<b>8.3.3.2</b>	<b>Text fields</b> .....	<b>8-58</b>
▪ 8.3.3.2.1	Applicable criteria and guidelines .....	8-58
▪ 8.3.3.2.2	When to use .....	8-58
▪ 8.3.3.2.3	Scrolling fields .....	8-58
<b>8.3.3.3</b>	<b>Scroll bars</b> .....	<b>8-58</b>
▪ 8.3.3.3.1	When to use .....	8-58
▪ 8.3.3.3.2	Scroll bar components .....	8-58
□ 8.3.3.3.3	Current display symbol .....	8-58
▪ 8.3.3.3.4	Required scroll bar operations .....	8-58
□ 8.3.3.3.5	Recommended display symbol .....	8-58
<b>8.3.4</b>	<b>Window states</b> .....	<b>8-59</b>
<b>8.3.4.1</b>	<b>Open, closed, iconized</b> .....	<b>8-59</b>
▪ 8.3.4.1.1	Open window .....	8-59
▪ 8.3.4.1.2	Closed window .....	8-59
▪ 8.3.4.1.3	Closing a primary window .....	8-59
□ 8.3.4.1.4	Closing a secondary window .....	8-59
▪ 8.3.4.1.5	Iconized windows .....	8-59
▪ 8.3.4.1.6	Restoring an iconized window .....	8-59
<b>8.3.4.2</b>	<b>Active, inactive</b> .....	<b>8-59</b>
▪ 8.3.4.2.1	Active windows .....	8-59
▪ 8.3.4.2.2	Making a window active .....	8-60
▪ 8.3.4.2.3	Making a window inactive .....	8-60
<b>8.3.4.3</b>	<b>Input focus</b> .....	<b>8-60</b>
▪ 8.3.4.3.1	One input focus .....	8-60
▪ 8.3.4.3.2	User assignable input focus .....	8-60
▪ 8.3.4.3.3	Assigning input focus with a pointing device .....	8-60
▪ 8.3.4.3.4	Assigning input focus with the keyboard .....	8-60
▪ 8.3.4.3.5	Single object focus .....	8-60
▪ 8.3.4.3.6	Location cursor .....	8-61
▪ 8.3.4.3.7	Assigning input focus to an object .....	8-61

	<ul style="list-style-type: none"> <li>▪ 8.3.4.3.8 Moving input focus to an object with a pointing device ..... 8-61</li> </ul>	
<b>8.3.4.4 Window mode</b>	.....	<b>8-61</b>
	<ul style="list-style-type: none"> <li>▪ 8.3.4.4.1 Primary window mode ..... 8-61</li> <li>▪ 8.3.4.4.2 Secondary window mode ..... 8-61</li> </ul>	
<b>8.3.5 Window operations</b>	.....	<b>8-61</b>
	<ul style="list-style-type: none"> <li>▪ 8.3.5.1 Restoring window to default size ..... 8-62</li> <li>▪ 8.3.5.2 Move ..... 8-62</li> <li>▪ 8.3.5.3 Moving a window with a pointing device ..... 8-62</li> <li>▪ 8.3.5.4 Moving a window using the keyboard ..... 8-62</li> <li>▪ 8.3.5.5 Resize ..... 8-62</li> <li>▪ 8.3.5.6 Resizing a window using a pointing device ..... 8-62</li> <li>▪ 8.3.5.7 Resizing a window using the keyboard ..... 8-63</li> <li>▪ 8.3.5.8 Iconize ..... 8-63</li> <li>▪ 8.3.5.9 Iconizing a window using a pointing device ..... 8-63</li> <li>▪ 8.3.5.10 Iconizing a window using the keyboard ..... 8-63</li> <li>▪ 8.3.5.11 Restoring an icon using a pointing device ..... 8-63</li> <li>▪ 8.3.5.12 Restoring an icon using the keyboard ..... 8-63</li> <li>▪ 8.3.5.13 Maximize ..... 8-63</li> <li>▪ 8.3.5.14 Close ..... 8-63</li> <li>□ 8.3.5.15 Next window ..... 8-64</li> <li>□ 8.3.5.16 Previous window ..... 8-64</li> <li>□ 8.3.5.17 Moving and copying objects ..... 8-64</li> </ul>	
<b>8.3.6 Window navigation</b>	.....	<b>8-64</b>
	<ul style="list-style-type: none"> <li>□ 8.3.6.1 Software navigation aids ..... 8-64</li> <li>□ 8.3.6.2 Open window map ..... 8-64</li> <li>□ 8.3.6.3 Active designation from open window map ..... 8-64</li> <li>□ 8.3.6.4 Expanded window explanation of open window map ..... 8-64</li> <li>□ 8.3.6.5 Window forward function with window map ..... 8-65</li> </ul>	
<b>8.3.7 Menus</b>	.....	<b>8-65</b>
<b>8.3.7.1 General</b>	.....	<b>8-65</b>
	<ul style="list-style-type: none"> <li>▪ 8.3.7.1.1 Applicable criteria and guidelines ..... 8-65</li> <li>□ 8.3.7.1.2 Wording of options ..... 8-65</li> </ul>	
<b>8.3.7.2 Mnemonics and keyboard accelerators</b>	.....	<b>8-65</b>
	<ul style="list-style-type: none"> <li>□ 8.3.7.2.1 Mnemonics ..... 8-65</li> <li>▪ 8.3.7.2.2 Single letter mnemonic ..... 8-65</li> <li>▪ 8.3.7.2.3 Selecting an option using its mnemonic ..... 8-66</li> <li>▪ 8.3.7.2.4 Selecting an option in a menu bar using its mnemonic ..... 8-66</li> <li>□ 8.3.7.2.5 Keyboard accelerators ..... 8-66</li> <li>▪ 8.3.7.2.6 Selecting an option in a menu using its accelerator ..... 8-66</li> </ul>	

■ 8.3.7.2.7 Case sensitivity of mnemonics and keyboard accelerators .....	8-66
■ 8.3.7.2.8 Consistency of mnemonics and keyboard accelerators .....	8-66
■ 8.3.7.2.9 Displaying mnemonics and accelerators .....	8-66
<b>Exhibit 8.3.7.2.9</b> Example of mnemonics and accelerators .....	8-66
<b>8.3.7.3 Pull-down menus</b> .....	<b>8-66</b>
■ 8.3.7.3.1 Title .....	8-66
□ 8.3.7.3.2 Presentation of options .....	8-67
■ 8.3.7.3.3 Ordering and grouping of options .....	8-67
■ 8.3.7.3.4 Navigation and selection .....	8-67
■ 8.3.7.3.5 Pull-down menu options .....	8-67
□ 8.3.7.3.6 Number of options .....	8-67
■ 8.3.7.3.7 Distinguishing unavailable options .....	8-67
<b>8.3.7.4 Scrolling menus</b> .....	<b>8-67</b>
■ 8.3.7.4.1 Format .....	8-68
□ 8.3.7.4.2 Order of options .....	8-68
■ 8.3.7.4.3 Number of options displayed .....	8-68
■ 8.3.7.4.4 Display of all options in a scrolling menu .....	8-68
□ 8.3.7.4.5 Search capability .....	8-68
□ 8.3.7.4.6 Editing scrolling menus .....	8-68
<b>8.3.8 Text edit windows</b> .....	<b>8-68</b>
■ 8.3.8.1 Text cursor .....	8-68
■ 8.3.8.2 Text cursor location .....	8-68
■ 8.3.8.3 Moving the text cursor .....	8-69
■ 8.3.8.4 Text cursor display .....	8-69
□ 8.3.8.5 Pointer visibility .....	8-69
□ 8.3.8.6 Insert mode .....	8-69
□ 8.3.8.7 Manipulating text .....	8-69
■ 8.3.8.8 Text entry .....	8-69
<b>8.3.9 System-level windows</b> .....	<b>8-69</b>
<b>8.3.9.1 System log on and log off</b> .....	<b>8-69</b>
■ 8.3.9.1.1 System access through log on process .....	8-69
□ 8.3.9.1.2 Log on screen or window .....	8-69
■ 8.3.9.1.3 Log on procedure .....	8-69
□ 8.3.9.1.4 System startup .....	8-70
■ 8.3.9.1.5 User-initiated log off .....	8-70
□ 8.3.9.1.6 Automatic log off .....	8-70
<b>8.3.9.2 The system window</b> .....	<b>8-70</b>
■ 8.3.9.2.1 Appearance .....	8-70

	▪ 8.3.9.2.2 System window components .....	8-70
	▪ 8.3.9.2.3 System window behavior .....	8-71
<b>8.3.9.3 The system menu</b>	.....	<b>8-71</b>
	▪ 8.3.9.3.1 Integration of applications into system-level menus .....	8-71
	□ 8.3.9.3.2 System window menu bar .....	8-71
	□ 8.3.9.3.3 Consistency across systems .....	8-71
	□ 8.3.9.3.4 Access to Help .....	8-71
	□ 8.3.9.3.5 Navigation aid .....	8-71
<b>8.3.9.4 System support</b>	.....	<b>8-71</b>
	□ 8.3.9.4.1 System menu .....	8-71
	□ 8.3.9.4.2 System window components .....	8-72
	□ 8.3.9.4.3 Additional support functions .....	8-72
	□ 8.3.9.4.4 User-specified settings .....	8-72
<b>8.3.10 Application-level windows</b>	.....	<b>8-72</b>
<b>8.3.10.1 Window organization</b>	.....	<b>8-72</b>
	▪ 8.3.10.1.1 Components of application windows .....	8-72
	▪ 8.3.10.1.2 Window title .....	8-73
	□ 8.3.10.1.3 Window menu bars .....	8-73
	□ 8.3.10.1.4 Names of menu bar options .....	8-73
	□ 8.3.10.1.5 Push buttons .....	8-73
	□ 8.3.10.1.6 Help button .....	8-73
	□ 8.3.10.1.7 Action icons .....	8-73
	▪ 8.3.10.1.8 Action icons bound to window .....	8-74
	□ 8.3.10.1.9 Message area .....	8-74
	▪ 8.3.10.1.10 Consistency in window organization .....	8-74
	□ 8.3.10.1.11 Control windows (dialog boxes) .....	8-74
	<b>Exhibit 8.3.10.1.11 Example of a control window</b> .....	<b>8-75</b>
<b>8.3.10.2 Message windows</b>	.....	<b>8-74</b>
	□ 8.3.10.2.1 Allowed operations .....	8-74
	□ 8.3.10.2.2 Disallowed operations .....	8-74
	□ 8.3.10.2.3 Message windows -- contents .....	8-75
	□ 8.3.10.2.4 Message wording .....	8-75
	□ 8.3.10.2.5 Message windows -- size and location .....	8-75
	□ 8.3.10.2.6 Request message windows .....	8-75
	□ 8.3.10.2.7 Error message windows .....	8-76
	□ 8.3.10.2.8 Information message windows .....	8-76
	▪ 8.3.10.2.9 Information message window behavior .....	8-76
	□ 8.3.10.2.10 Confirmation message windows .....	8-76
	□ 8.3.10.2.11 Warning message windows .....	8-76
	□ 8.3.10.2.12 Accompanying audible warning signals .....	8-76

■ 8.3.10.2.13 "Working" message windows .....	8-76
□ 8.3.10.2.14 Progressive working messages .....	8-76
<b>8.3.10.3 Use of color in windows</b> .....	<b>8-77</b>
■ 8.3.10.3.1 Applicable criteria and guidelines .....	8-77
■ 8.3.10.3.2 Consistent use of color .....	8-77
□ 8.3.10.3.3 Limited use of color .....	8-77
■ 8.3.10.3.4 Coding and status colors .....	8-77
□ 8.3.10.3.5 User preferences .....	8-77
<b>8.3.10.4 Text in windows</b> .....	<b>8-77</b>
□ 8.3.10.4.1 Contrast .....	8-77
□ 8.3.10.4.2 Dot matrices .....	8-77
□ 8.3.10.4.3 Minimum character height .....	8-77
□ 8.3.10.4.4 User-selectable font size .....	8-77
□ 8.3.10.4.5 Arabic vs. Roman numerals .....	8-77
□ 8.3.10.4.6 Capitalization .....	8-78
□ 8.3.10.4.7 Acronyms .....	8-78
□ 8.3.10.4.8 Abbreviations .....	8-78
■ 8.3.10.4.9 Formation of acronyms and abbreviations .....	8-78
■ 8.3.10.4.10 Dictionary of acronyms and abbreviations .....	8-78
□ 8.3.10.4.11 Consistent structure for noneditable text .....	8-78
■ 8.3.10.4.12 Vocabulary .....	8-78
□ 8.3.10.4.13 Sentence structure .....	8-78
□ 8.3.10.4.14 Punctuation .....	8-78
■ 8.3.10.4.15 Sequences .....	8-78
■ 8.3.10.4.16 Referents .....	8-78
□ 8.3.10.4.17 Case conversion .....	8-78
□ 8.3.10.4.18 Wild card search characters .....	8-79
<b>8.3.11 Window management considerations</b> .....	<b>8-79</b>
□ 8.3.11.1 Initial window contents and organization .....	8-79
□ 8.3.11.2 Initial size .....	8-79
□ 8.3.11.3 Initial placement .....	8-79
□ 8.3.11.4 Resizing .....	8-79
□ 8.3.11.5 Mode of windows .....	8-79
<b>8.3.12 Task-specific windows</b> .....	<b>8-80</b>
<b>8.3.12.1 Help windows</b> .....	<b>8-80</b>
□ 8.3.12.1.1 Help availability .....	8-80
□ 8.3.12.1.2 Help window elements .....	8-80
□ 8.3.12.1.3 Size and placement .....	8-80
□ 8.3.12.1.4 Help information .....	8-80
□ 8.3.12.1.5 Wording of help information .....	8-81
□ 8.3.12.1.6 Removal of help windows .....	8-81

<b>8.3.12.2 Data entry windows</b>	.....	<b>8-81</b>
□ 8.3.12.2.1 Data entry window elements	.....	8-81
□ 8.3.12.2.2 Data window organization	.....	8-81
□ 8.3.12.2.3 Multipage data entry window	.....	8-81
□ 8.3.12.2.4 Push buttons in data entry windows	.....	8-81
□ 8.3.12.2.5 Controls for data entry windows	.....	8-81
□ 8.3.12.2.6 Help on data entry fields	.....	8-82
■ 8.3.12.2.7 Data entry fields	.....	8-82
■ 8.3.12.2.8 Labeling data fields	.....	8-82
■ 8.3.12.2.9 Navigation in data entry windows	.....	8-82
■ 8.3.12.2.10 Data entry and editing in data entry windows	.....	8-82
■ 8.3.12.2.11 Saving entered data	.....	8-82
<b>8.3.12.3 Text windows</b>	.....	<b>8-82</b>
□ 8.3.12.3.1 Width of a text window	.....	8-82
■ 8.3.12.3.2 Vertical scroll bars	.....	8-82
□ 8.3.12.3.3 Document operations	.....	8-82
□ 8.3.12.3.4 Text manipulation	.....	8-82
□ 8.3.12.3.5 Search and replace capabilities	.....	8-83
<b>8.3.12.4 Map windows</b>	.....	<b>8-83</b>
□ 8.3.12.4.1 Map window elements	.....	8-83
□ 8.3.12.4.2 Map orientation	.....	8-83
□ 8.3.12.4.3 Consistent label position	.....	8-83
□ 8.3.12.4.4 Label legibility	.....	8-83
□ 8.3.12.4.5 Color coding key	.....	8-83
■ 8.3.12.4.6 Symbols and color codes	.....	8-83
□ 8.3.12.4.7 User control of map appearance	.....	8-83
□ 8.3.12.4.8 User editing of labels and overlays	.....	8-84
□ 8.3.12.4.9 "Reading" a map	.....	8-84
□ 8.3.12.4.10 Crowded, cluttered maps	.....	8-84
□ 8.3.12.4.11 User control of automatic updating	.....	8-84
<b>8.3.12.5 Windows for sending and receiving electronic messages</b>	.....	<b>8-84</b>
■ 8.3.12.5.1 Message handling windows	.....	8-84
□ 8.3.12.5.2 Message window fields and headers	.....	8-84
□ 8.3.12.5.3 Field support	.....	8-84
□ 8.3.12.5.4 Distribution lists	.....	8-84
□ 8.3.12.5.5 Message transmission	.....	8-84
□ 8.3.12.5.6 Delayed or unsuccessful transmission	.....	8-84
□ 8.3.12.5.7 Message status information	.....	8-85
□ 8.3.12.5.8 Notification of message arrival	.....	8-85
□ 8.3.12.5.9 Queuing and logging incoming messages	.....	8-85
□ 8.3.12.5.10 Incoming message operations	.....	8-85

<b>8.4 Data entry</b>	.....	<b>8-85</b>
<b>8.4.1 Menus</b>	.....	<b>8-85</b>
<b>8.4.1.1 General</b>	.....	<b>8-85</b>
▪ 8.4.1.1.1 Consistent style	.....	8-85
▪ 8.4.1.1.2 Consistent wording and ordering	.....	8-85
□ 8.4.1.1.3 Scrollable menus	.....	8-86
▪ 8.4.1.1.4 Display of all options in a scrolling menu	.....	8-86
▪ 8.4.1.1.5 Distinguishing types of options	.....	8-86
▪ 8.4.1.1.6 Distinguishing unavailable options	.....	8-86
▪ 8.4.1.1.7 Instructions	.....	8-86
▪ 8.4.1.1.8 Menus distinct from other displayed information	.....	8-86
<b>8.4.1.2 Hierarchical menus</b>	.....	<b>8-86</b>
□ 8.4.1.2.1 When to use	.....	8-86
▪ 8.4.1.2.2 Applicable rules	.....	8-87
<b>8.4.1.3 Pull-down menus</b>	.....	<b>8-87</b>
□ 8.4.1.3.1 When to use	.....	8-87
▪ 8.4.1.3.2 Consistent location	.....	8-87
<b>8.4.1.4 Pop-up menus</b>	.....	<b>8-87</b>
□ 8.4.1.4.1 When to use	.....	8-87
▪ 8.4.1.4.2 Pop-up menu location	.....	8-87
□ 8.4.1.4.3 Selection highlighting	.....	8-87
<b>8.4.1.5 Format</b>	.....	<b>8-88</b>
□ 8.4.1.5.1 Presentation of options	.....	8-88
▪ 8.4.1.5.2 Consistent menus and options	.....	8-88
▪ 8.4.1.5.3 Logical grouping of menu options	.....	8-88
▪ 8.4.1.5.4 Ordering groups of options	.....	8-88
▪ 8.4.1.5.5 Ordering options within a group or menu	.....	8-88
<b>8.4.1.6 Selecting options</b>	.....	<b>8-88</b>
▪ 8.4.1.6.1 Equivalence of input devices	.....	8-88
□ 8.4.1.6.2 Menu selection by pointing	.....	8-88
□ 8.4.1.6.3 Method of selecting by pointing	.....	8-88
▪ 8.4.1.6.4 Initial cursor position for pointing devices	.....	8-88
▪ 8.4.1.6.5 Initial cursor position for keyboards	.....	8-89
▪ 8.4.1.6.6 Feedback for menu selection	.....	8-89
□ 8.4.1.6.7 Number of selections per menu	.....	8-89
<b>8.4.2 Text</b>	.....	<b>8-89</b>
<b>8.4.2.1 General</b>	.....	<b>8-89</b>
▪ 8.4.2.1.1 Text input area	.....	8-89
▪ 8.4.2.1.2 Distinctive appearance	.....	8-89

□ 8.4.2.1.3 Contrast .....	8-89
□ 8.4.2.1.4 Multiple input devices .....	8-89
■ 8.4.2.1.5 Multiple cursors .....	8-89
■ 8.4.2.1.6 Cursor movement .....	8-89
□ 8.4.2.1.7 Enhanced cursor movement .....	8-89
□ 8.4.2.1.8 Frequently used text blocks .....	8-90
□ 8.4.2.1.9 Spell checker .....	8-90
<b>8.4.2.2 Text entry and editing</b> .....	<b>8-90</b>
□ 8.4.2.2.1 Insert mode as default .....	8-90
□ 8.4.2.2.2 Action of Backspace and Delete .....	8-90
□ 8.4.2.2.3 Editing operations .....	8-90
□ 8.4.2.2.4 Searching text .....	8-90
□ 8.4.2.2.5 Global search and replace .....	8-90
□ 8.4.2.2.6 Editing units of text .....	8-90
□ 8.4.2.2.7 Highlighting units of text .....	8-90
<b>8.4.2.3 Formatting</b> .....	<b>8-90</b>
□ 8.4.2.3.1 Text format .....	8-90
□ 8.4.2.3.2 Page formatting .....	8-91
□ 8.4.2.3.3 Line breaks .....	8-91
□ 8.4.2.3.4 Justification of text .....	8-91
□ 8.4.2.3.5 Hyphenation .....	8-91
□ 8.4.2.3.6 Page breaks .....	8-91
□ 8.4.2.3.7 Page numbering .....	8-91
<b>8.4.2.4 Text cursor in windows</b> .....	<b>8-91</b>
■ 8.4.2.4.1 Text cursor .....	8-91
■ 8.4.2.4.2 Text cursor location .....	8-91
■ 8.4.2.4.3 Moving the text cursor .....	8-91
□ 8.4.2.4.4 Control entries distinguishable from text .....	8-92
<b>8.4.3 Forms</b> .....	<b>8-92</b>
<b>8.4.3.1 General</b> .....	<b>8-92</b>
■ 8.4.3.1.1 Title .....	8-92
■ 8.4.3.1.2 Consistency .....	8-92
■ 8.4.3.1.3 Field help .....	8-92
<b>8.4.3.2 Fields</b> .....	<b>8-92</b>
■ 8.4.3.2.1 Appearance .....	8-92
□ 8.4.3.2.2 Field length .....	8-92
■ 8.4.3.2.3 Entry does not overwrite field delineators .....	8-92
■ 8.4.3.2.4 Unfilled portion of field .....	8-92
■ 8.4.3.2.5 Required fields .....	8-93
■ 8.4.3.2.6 Optional fields distinct from required fields .....	8-93
■ 8.4.3.2.7 Intrafield separators .....	8-93
<b>8.4.3.3 Field labels</b> .....	<b>8-93</b>
■ 8.4.3.3.1 Field labels .....	8-93



□ 8.4.3.3.2	Descriptive labels .....	8-93
□ 8.4.3.3.3	Terms used in labels .....	8-94
■ 8.4.3.3.4	Labels distinct from other information .....	8-94
■ 8.4.3.3.5	Label terminator .....	8-94
■ 8.4.3.3.6	Consistent location .....	8-94
■ 8.4.3.3.7	Unit of measurement .....	8-94
■ 8.4.3.3.8	Alternative units .....	8-94
■ 8.4.3.3.9	Labels not editable .....	8-94
<b>8.4.3.4</b>	<b>Layout .....</b>	<b>8-94</b>
■ 8.4.3.4.1	Correspondence between screen and document .....	8-94
■ 8.4.3.4.2	Layout with no source document .....	8-95
□ 8.4.3.4.3	Multipage forms .....	8-95
<b>8.4.3.5</b>	<b>Navigation .....</b>	<b>8-95</b>
■ 8.4.3.5.1	Initial cursor position .....	8-95
■ 8.4.3.5.2	Easy cursor movement .....	8-95
□ 8.4.3.5.3	No automatic movement .....	8-95
■ 8.4.3.5.4	Navigation only to fields .....	8-95
■ 8.4.3.5.5	Protected fields .....	8-95
□ 8.4.3.5.6	Moving to "next" and "previous" fields .....	8-95
□ 8.4.3.5.7	Navigation with a pointer .....	8-96
<b>8.4.3.6</b>	<b>Defaults .....</b>	<b>8-96</b>
□ 8.4.3.6.1	When to use .....	8-96
■ 8.4.3.6.2	Displaying default values .....	8-96
■ 8.4.3.6.3	Replacing default values in fields .....	8-96
<b>8.4.3.7</b>	<b>Data entry and editing .....</b>	<b>8-96</b>
■ 8.4.3.7.1	Unfilled spaces .....	8-96
■ 8.4.3.7.2	Leading and trailing zeros .....	8-96
■ 8.4.3.7.3	Justification of entries .....	8-96
■ 8.4.3.7.4	Interrupt capabilities .....	8-97
■ 8.4.3.7.5	Editing entries .....	8-97
■ 8.4.3.7.6	Explicit "completion" action .....	8-97
<b>8.4.3.8</b>	<b>Error management .....</b>	<b>8-97</b>
■ 8.4.3.8.1	Easy error correction .....	8-97
■ 8.4.3.8.2	Unacceptable entries .....	8-97
■ 8.4.3.8.3	Omitted fields .....	8-97
□ 8.4.3.8.4	Deliberate omissions .....	8-97
<b>8.4.4</b>	<b>Direct manipulation .....</b>	<b>8-97</b>
□ 8.4.4.1	Drag transfer .....	8-97
□ 8.4.4.2	Data and object transfer .....	8-98

<b>8.4.5 Tables</b>	.....	<b>8-98</b>
□ 8.4.5.1 When to use	.....	8-98
■ 8.4.5.2 Labels	.....	8-98
■ 8.4.5.3 Leading and trailing zeros	.....	8-98
■ 8.4.5.4 Automatic justification	.....	8-98
■ 8.4.5.5 Navigation with the Tab key	.....	8-98
■ 8.4.5.6 Navigating with a pointing device	.....	8-98
■ 8.4.5.7 Large tables	.....	8-98
■ 8.4.5.8 Labels in scrolling tables	.....	8-99
<b>8.4.6 Entry of graphics</b>	.....	<b>8-99</b>
<b>8.4.6.1 General</b>	.....	<b>8-99</b>
□ 8.4.6.1.1 Pointing device	.....	8-99
□ 8.4.6.1.2 Graphics cursor	.....	8-99
<b>Exhibit 8.4.6.1.2</b> Examples of better and worse graphics cursors	.....	8-99
□ 8.4.6.1.3 Graphics cursor operation	.....	8-99
□ 8.4.6.1.4 Validation on input	.....	8-99
■ 8.4.6.1.5 Saving and retrieving graphic data	.....	8-99
<b>8.4.6.2 Graphics entry and editing</b>	.....	<b>8-99</b>
□ 8.4.6.2.1 Drawing lines	.....	8-99
□ 8.4.6.2.2 Constraining lines	.....	8-99
□ 8.4.6.2.3 Alignment grid	.....	8-100
□ 8.4.6.2.4 Alternate drawing methods	.....	8-100
□ 8.4.6.2.5 Closure	.....	8-100
□ 8.4.6.2.6 Displaying attributes	.....	8-100
□ 8.4.6.2.7 Colors and patterns	.....	8-100
□ 8.4.6.2.8 Selectable elements and attributes	.....	8-100
□ 8.4.6.2.9 Manipulating objects	.....	8-100
□ 8.4.6.2.10 Editing objects	.....	8-100
□ 8.4.6.2.11 Scaling objects	.....	8-100
□ 8.4.6.2.12 Zoom capability	.....	8-100
□ 8.4.6.2.13 Overlapping objects	.....	8-100
□ 8.4.6.2.14 Grouping objects	.....	8-100
<b>8.4.6.3 User aids</b>	.....	<b>8-101</b>
□ 8.4.6.3.1 Entering data for plotting	.....	8-101
□ 8.4.6.3.2 Plotting stored data	.....	8-101
□ 8.4.6.3.3 Scaling graphic data	.....	8-101
□ 8.4.6.3.4 Emergence of drawn objects	.....	8-101
<b>8.4.7 Data validation</b>	.....	<b>8-101</b>
□ 8.4.7.1 Format and content	.....	8-101
□ 8.4.7.2 Valid data	.....	8-101
□ 8.4.7.3 Invalid data	.....	8-101
□ 8.4.7.4 Probable errors	.....	8-101

<b>8.5 Data display</b>	.....	<b>8-101</b>
<b>8.5.1 General</b>	.....	<b>8-101</b>
□ 8.5.1.1 Independence	.....	8-101
■ 8.5.1.2 Consistent with user expectations	.....	8-102
■ 8.5.1.3 Consistent within applications	.....	8-102
□ 8.5.1.4 Whole data sets	.....	8-102
□ 8.5.1.5 Information density	.....	8-102
■ 8.5.1.6 Usable, essential data for a transaction	.....	8-102
□ 8.5.1.7 User control	.....	8-102
□ 8.5.1.8 Paper copy	.....	8-102
□ 8.5.1.9 Date and time information	.....	8-102
□ 8.5.1.10 Familiar wording	.....	8-102
■ 8.5.1.11 Display formats	.....	8-102
□ 8.5.1.12 Blank space	.....	8-102
□ 8.5.1.13 Grouped information	.....	8-102
□ 8.5.1.14 Reserved area	.....	8-103
□ 8.5.1.15 Layout for comparisons	.....	8-103
□ 8.5.1.16 Character-by-character comparisons	.....	8-103
■ 8.5.1.17 Arranging data	.....	8-103
□ 8.5.1.18 Context	.....	8-103
□ 8.5.1.19 Multipage displays	.....	8-103
□ 8.5.1.20 Partitioning data among pages	.....	8-103
□ 8.5.1.21 Labeling pages	.....	8-103
<b>8.5.2 Text</b>	.....	<b>8-103</b>
<b>8.5.2.1 General</b>	.....	<b>8-103</b>
■ 8.5.2.1.1 Consistent wording and structure	.....	8-103
□ 8.5.2.1.2 Contrast	.....	8-103
<b>8.5.2.2 Labeling</b>	.....	<b>8-103</b>
□ 8.5.2.2.1 Distinct, unique, descriptive labels	.....	8-103
□ 8.5.2.2.2 Alphanumeric labels	.....	8-103
□ 8.5.2.2.3 Consistency	.....	8-104
□ 8.5.2.2.4 Spacing	.....	8-104
<b>8.5.3 Forms</b>	.....	<b>8-104</b>
□ 8.5.3.1 Distinctive fields	.....	8-104
<b>8.5.4 Coding</b>	.....	<b>8-104</b>
<b>8.5.4.1 General</b>	.....	<b>8-104</b>
□ 8.5.4.1.1 Meaningful codes	.....	8-104
□ 8.5.4.1.2 When to use	.....	8-104
□ 8.5.4.1.3 Coding data categories	.....	8-104
■ 8.5.4.1.4 Consistent coding	.....	8-104
□ 8.5.4.1.5 Special codes	.....	8-104

<b>8.5.4.2 Alphanumeric coding</b>	.....	<b>8-104</b>
□ 8.5.4.2.1 Supplemental use only	.....	8-104
■ 8.5.4.2.2 Case of letters	.....	8-104
□ 8.5.4.2.3 Mixed letter and number codes	.....	8-104
□ 8.5.4.2.4 Length of codes	.....	8-105
<b>8.5.4.3 Auditory coding</b>	.....	<b>8-105</b>
■ 8.5.4.3.1 Acknowledging auditory signals	.....	8-105
■ 8.5.4.3.2 User control	.....	8-105
□ 8.5.4.3.3 Delayed computer response	.....	8-105
□ 8.5.4.3.4 Nature of auditory signals	.....	8-105
□ 8.5.4.3.5 Environmental compatibility	.....	8-105
<b>8.5.4.4 Brightness intensity coding</b>	.....	<b>8-105</b>
■ 8.5.4.4.1 Consistent meaning	.....	8-105
■ 8.5.4.4.2 Number of levels	.....	8-105
■ 8.5.4.4.3 Brightness ratios	.....	8-105
<b>8.5.4.5 Color coding</b>	.....	<b>8-105</b>
■ 8.5.4.5.1 Reserved meanings	.....	8-106
■ 8.5.4.5.2 Color coding data categories	.....	8-106
□ 8.5.4.5.3 Redundant use	.....	8-106
■ 8.5.4.5.4 Use of color	.....	8-106
□ 8.5.4.5.5 Drawing attention	.....	8-106
<b>8.5.4.6 Flash coding</b>	.....	<b>8-106</b>
■ 8.5.4.6.1 Limited use	.....	8-106
■ 8.5.4.6.2 Flashing rate	.....	8-106
■ 8.5.4.6.3 Second flashing rate	.....	8-107
■ 8.5.4.6.4 Displayed objects	.....	8-107
□ 8.5.4.6.5 Flash acknowledgment	.....	8-107
<b>8.5.4.7 Line coding</b>	.....	<b>8-107</b>
□ 8.5.4.7.1 Length	.....	8-107
□ 8.5.4.7.2 Direction	.....	8-107
□ 8.5.4.7.3 Number of coded lines	.....	8-107
<b>8.5.4.8 Symbol coding</b>	.....	<b>8-107</b>
□ 8.5.4.8.1 Design of symbols	.....	8-107
■ 8.5.4.8.2 Special symbols	.....	8-107
<b>8.5.4.9 Shape coding</b>	.....	<b>8-107</b>
■ 8.5.4.9.1 Number of shape codes	.....	8-107

<b>8.5.4.10 Size coding</b>	.....	<b>8-107</b>
▪ 8.5.4.10.1 Number of sizes	.....	8-107
<b>8.5.5 Display of graphics</b>	.....	<b>8-107</b>
<b>8.5.5.1 General</b>	.....	<b>8-108</b>
▪ 8.5.5.1.1 Complex formats	.....	8-108
□ 8.5.5.1.2 Robustness	.....	8-108
▪ 8.5.5.1.3 Appropriateness of format	.....	8-108
□ 8.5.5.1.4 Only needed data	.....	8-108
□ 8.5.5.1.5 User selection of style	.....	8-108
□ 8.5.5.1.6 Value display	.....	8-108
▪ 8.5.5.1.7 Consistency	.....	8-108
▪ 8.5.5.1.8 Labels	.....	8-108
<b>8.5.5.2 Display of critical data</b>	.....	<b>8-108</b>
▪ 8.5.5.2.1 Reference values	.....	8-108
□ 8.5.5.2.2 Display data values with graphics	.....	8-108
▪ 8.5.5.2.3 Consistent labeling location	.....	8-108
□ 8.5.5.2.4 Supplementary text	.....	8-108
<b>8.5.5.3 Creating and editing</b>	.....	<b>8-108</b>
□ 8.5.5.3.1 Validation	.....	8-109
□ 8.5.5.3.2 Plotting aids	.....	8-109
□ 8.5.5.3.3 Plotting stored data	.....	8-109
□ 8.5.5.3.4 Automated production of scales	.....	8-109
□ 8.5.5.3.5 Line drawing	.....	8-109
□ 8.5.5.3.6 Automatic completion of polygons	.....	8-109
□ 8.5.5.3.7 Joining lines	.....	8-109
□ 8.5.5.3.8 Designating line segments	.....	8-109
□ 8.5.5.3.9 Grid references	.....	8-109
□ 8.5.5.3.10 User-specified rules	.....	8-109
□ 8.5.5.3.11 Computer aids	.....	8-109
□ 8.5.5.3.12 Scale changes	.....	8-109
□ 8.5.5.3.13 Basic operations	.....	8-109
□ 8.5.5.3.14 Grouping elements	.....	8-110
□ 8.5.5.3.15 Area fill capability	.....	8-110
□ 8.5.5.3.16 Computer models	.....	8-110
<b>8.5.5.4 Scales, labels, and coding</b>	.....	<b>8-110</b>
▪ 8.5.5.4.1 Standard conventions	.....	8-110
▪ 8.5.5.4.2 Consistent use of symbols	.....	8-110
□ 8.5.5.4.3 Color and pattern coding	.....	8-110
□ 8.5.5.4.4 Patterns	.....	8-111

<b>Exhibit 8.5.5.4.4</b> Examples of acceptable and unacceptable patterns .....	8-111
■ <b>8.5.5.4.5</b> Breaks in axes .....	8-111
<b>Exhibit 8.5.5.4.5</b> Examples of axes with breaks .....	8-111
□ <b>8.5.5.4.6</b> Duplicate axes .....	8-111
■ <b>8.5.5.4.7</b> Consistent formats .....	8-111
□ <b>8.5.5.4.8</b> Linear scales .....	8-111
□ <b>8.5.5.4.9</b> Single scale per axis .....	8-111
■ <b>8.5.5.4.10</b> Labeling axes .....	8-111
□ <b>8.5.5.4.11</b> Scale divisions .....	8-112
■ <b>8.5.5.4.12</b> Numeric scales .....	8-112
□ <b>8.5.5.4.13</b> Label format .....	8-112
□ <b>8.5.5.4.14</b> Labeling data elements .....	8-112
■ <b>8.5.5.4.15</b> Location of legends and keys .....	8-112
<b>8.5.5.5 Grid lines</b> .....	<b>8-112</b>
□ <b>8.5.5.5.1</b> When to use .....	8-112
□ <b>8.5.5.5.2</b> Grid lines vs. Data .....	8-112
□ <b>8.5.5.5.3</b> User choice .....	8-112
<b>8.5.5.6 Lines and curves</b> .....	<b>8-113</b>
□ <b>8.5.5.6.1</b> Use of lines and curves .....	8-113
□ <b>8.5.5.6.2</b> Labeling and highlighting multiple lines and curves .....	8-113
■ <b>8.5.5.6.3</b> Coding lines and curves .....	8-113
□ <b>8.5.5.6.4</b> Cyclic data .....	8-113
□ <b>8.5.5.6.5</b> Projected values .....	8-113
<b>8.5.5.7 Areas</b> .....	<b>8-113</b>
□ <b>8.5.5.7.1</b> Area between curves .....	8-113
□ <b>8.5.5.7.2</b> Stacked curves .....	8-113
□ <b>8.5.5.7.3</b> Labeling areas .....	8-113
<b>8.5.5.8 Scatterplots</b> .....	<b>8-113</b>
□ <b>8.5.5.8.1</b> When to use .....	8-113
□ <b>8.5.5.8.2</b> Highlighting points .....	8-113
<b>8.5.5.9 Pie charts</b> .....	<b>8-114</b>
□ <b>8.5.5.9.1</b> When to use .....	8-114
□ <b>8.5.5.9.2</b> When not to use .....	8-114
□ <b>8.5.5.9.3</b> Labeling pie charts .....	8-114
□ <b>8.5.5.9.4</b> Highlighting segments .....	8-114
<b>8.5.5.10 Pictures</b> .....	<b>8-114</b>
□ <b>8.5.5.10.1</b> Automated aids .....	8-114

<b>8.5.5.11 Diagrams</b>	.....	<b>8-114</b>
□ 8.5.5.11.1 Large diagrams	.....	8-114
□ 8.5.5.11.2 Highlighting portions of diagrams	.....	8-114
□ 8.5.5.11.3 Rotation of diagrams	.....	8-114
<b>8.5.5.12 Flowcharts</b>	.....	<b>8-114</b>
□ 8.5.5.12.1 Flowchart design	.....	8-114
■ 8.5.5.12.2 Consistency	.....	8-115
□ 8.5.5.12.3 Highlighting	.....	8-115
□ 8.5.5.12.4 Flowcharts as decision aids	.....	8-115
□ 8.5.5.12.5 Flowchart orientation	.....	8-115
<b>8.5.6 Display control</b>	.....	<b>8-115</b>
<b>8.5.6.1 General</b>	.....	<b>8-115</b>
□ 8.5.6.1.1 User tailoring	.....	8-115
□ 8.5.6.1.2 Return to normal display	.....	8-115
<b>8.5.6.2 Display of control options</b>	.....	<b>8-115</b>
■ 8.5.6.2.1 Control locations and options	.....	8-115
■ 8.5.6.2.2 Default values	.....	8-115
■ 8.5.6.2.3 Control information	.....	8-115
<b>8.5.6.3 Data access</b>	.....	<b>8-116</b>
□ 8.5.6.3.1 Moving through data	.....	8-116
□ 8.5.6.3.2 Moving through continuous text	.....	8-116
□ 8.5.6.3.3 Moving through grouped information	.....	8-116
<b>8.5.6.4 Panning and zooming</b>	.....	<b>8-116</b>
□ 8.5.6.4.1 When to provide scrolling, paging, and panning ...	8-116	
□ 8.5.6.4.2 When to provide zooming	.....	8-116
□ 8.5.6.4.3 Scale indication	.....	8-116
□ 8.5.6.4.4 Scale integration	.....	8-116
<b>8.5.6.5 Information suppression</b>	.....	<b>8-116</b>
■ 8.5.6.5.1 Suppression indication	.....	8-116
□ 8.5.6.5.2 Indication of changes in suppressed information ..	8-117	
■ 8.5.6.5.3 Restoration of suppressed information	.....	8-117
<b>8.5.6.6 Labeling and marking information</b>	.....	<b>8-117</b>
■ 8.5.6.6.1 Display identification	.....	8-117
■ 8.5.6.6.2 Labels	.....	8-117

■ 8.5.6.6.3	Numbering multipage displays .....	8-117
■ 8.5.6.6.4	Numbering items in multidisplay lists .....	8-117
<b>8.5.7 Display regeneration and updating</b>	.....	<b>8-117</b>
<b>8.5.7.1 General</b>	.....	<b>8-117</b>
■ 8.5.7.1.1	Update rate .....	8-117
■ 8.5.7.1.2	"Real time" data .....	8-117
□ 8.5.7.1.3	Alphanumeric data .....	8-117
<b>8.5.7.2 User control</b>	.....	<b>8-117</b>
□ 8.5.7.2.1	Display regeneration .....	8-117
□ 8.5.7.2.2	User control of rate of update .....	8-118
□ 8.5.7.2.3	Automatic updating .....	8-118
<b>8.5.7.3 Freeze frame</b>	.....	<b>8-118</b>
□ 8.5.7.3.1	"Freezing" changing data .....	8-118
■ 8.5.7.3.2	Labeling a frozen display .....	8-118
□ 8.5.7.3.3	Notification of changes while display is frozen .....	8-118
■ 8.5.7.3.4	Unfreezing a display .....	8-118
<b>8.5.8 Maps and situation displays</b>	.....	<b>8-118</b>
<b>8.5.8.1 General</b>	.....	<b>8-118</b>
□ 8.5.8.1.1	User expectations .....	8-118
□ 8.5.8.1.2	Amount of detail .....	8-118
□ 8.5.8.1.3	Map manipulation tools .....	8-118
□ 8.5.8.1.4	Curvature .....	8-118
□ 8.5.8.1.5	Situation displays as overlays .....	8-118
□ 8.5.8.1.6	Labeling features .....	8-119
□ 8.5.8.1.7	Consistent label position .....	8-119
□ 8.5.8.1.8	Consistent orientation .....	8-119
□ 8.5.8.1.9	Coding areas .....	8-119
□ 8.5.8.1.10	Automated tools .....	8-119
<b>8.5.8.2 Static display attributes</b>	.....	<b>8-119</b>
■ 8.5.8.2.1	Map coverage .....	8-119
■ 8.5.8.2.2	Necessary features .....	8-119
■ 8.5.8.2.3	Label legibility .....	8-119
□ 8.5.8.2.4	Reducing clutter .....	8-119
□ 8.5.8.2.5	Association of symbols with map features .....	8-119
□ 8.5.8.2.6	Automatic registration .....	8-119
□ 8.5.8.2.7	Symbol identification key .....	8-119
■ 8.5.8.2.8	Color coding symbols .....	8-120
□ 8.5.8.2.9	Nonoverlapping of symbols .....	8-120
□ 8.5.8.2.10	Labeling symbols .....	8-120



□ 8.5.8.2.11	Coordinate readings .....	8-120
□ 8.5.8.2.12	Determining coordinates .....	8-120
□ 8.5.8.2.13	Context for displayed map .....	8-120
□ 8.5.8.2.14	Determining distances .....	8-120
□ 8.5.8.2.15	Determining bearings .....	8-120
<b>8.5.8.3</b>	<b>Dynamic display attributes .....</b>	<b>8-120</b>
□ 8.5.8.3.1	Panning .....	8-120
□ 8.5.8.3.2	Location information .....	8-120
□ 8.5.8.3.3	Return to start .....	8-120
□ 8.5.8.3.4	Zooming .....	8-120
■ 8.5.8.3.5	Zooming and legibility .....	8-121
□ 8.5.8.3.6	Discrete vs. continuous zooming .....	8-121
□ 8.5.8.3.7	Return to default .....	8-121
□ 8.5.8.3.8	Indication of changing scale .....	8-121
□ 8.5.8.3.9	Indication of displayed portion of map .....	8-121
□ 8.5.8.3.10	Selecting information for updating .....	8-121
□ 8.5.8.3.11	Stable reference elements .....	8-121
□ 8.5.8.3.12	Identification of updates .....	8-121
□ 8.5.8.3.13	Control of frequency of updating .....	8-121
□ 8.5.8.3.14	Rate of updating .....	8-121
□ 8.5.8.3.15	Freezing a dynamic display .....	8-121
□ 8.5.8.3.16	Control of rate of sequencing .....	8-121
□ 8.5.8.3.17	Freezing a sequence .....	8-122
□ 8.5.8.3.18	Direction of sequencing .....	8-122
□ 8.5.8.3.19	Viewing selected displays .....	8-122
□ 8.5.8.3.20	Grid overlay .....	8-122
□ 8.5.8.3.21	Map legend .....	8-122
<b>8.5.8.4</b>	<b>Creating and editing map graphics .....</b>	<b>8-122</b>
□ 8.5.8.4.1	Standard symbol library .....	8-122
□ 8.5.8.4.2	Labeling symbols .....	8-122
□ 8.5.8.4.3	Tools for constructing symbols and overlays .....	8-122
□ 8.5.8.4.4	Editing displays .....	8-122
□ 8.5.8.4.5	Expanding displays .....	8-122
□ 8.5.8.4.6	Editing display elements .....	8-122
□ 8.5.8.4.7	Identifying attributes .....	8-123
□ 8.5.8.4.8	Changing display attributes .....	8-123
□ 8.5.8.4.9	Changing display attributes by selection .....	8-123
□ 8.5.8.4.10	Print preview .....	8-123
<b>8.5.8.5</b>	<b>Map display characteristics .....</b>	<b>8-123</b>
□ 8.5.8.5.1	Map visibility .....	8-123
□ 8.5.8.5.2	Map cursor .....	8-123
□ 8.5.8.5.3	Filters .....	8-123
□ 8.5.8.5.4	Text and overlays .....	8-123
■ 8.5.8.5.5	Color in overlays .....	8-123
□ 8.5.8.5.6	Intensity .....	8-123
□ 8.5.8.5.7	Map as background .....	8-123

<b>8.5.9 Voice displays</b>	.....	<b>8-124</b>
<b>8.5.9.1 Word selection</b>	.....	<b>8-124</b>
■ 8.5.9.1.1 Word choice	.....	8-124
□ 8.5.9.1.2 Words to avoid	.....	8-124
□ 8.5.9.1.3 "Formal" words	.....	8-124
□ 8.5.9.1.4 Alphabetic information	.....	8-124
<b>8.5.9.2 Presentation</b>	.....	<b>8-124</b>
□ 8.5.9.2.1 "Average talker"	.....	8-124
□ 8.5.9.2.2 Distinctive voices	.....	8-124
□ 8.5.9.2.3 Content	.....	8-124
□ 8.5.9.2.4 Speech quality	.....	8-124
□ 8.5.9.2.5 Alerting signals	.....	8-124
□ 8.5.9.2.6 Acknowledging warning signals	.....	8-124
<b>8.6 User guidance</b>	.....	<b>8-125</b>
<b>8.6.1 On-line help</b>	.....	<b>8-125</b>
<b>8.6.1.1 General</b>	.....	<b>8-126</b>
■ 8.6.1.1.1 Applicable criteria and guidelines	.....	8-126
□ 8.6.1.1.2 Availability of on-line help	.....	8-126
□ 8.6.1.1.3 On-line guidance	.....	8-126
□ 8.6.1.1.4 User-centered help	.....	8-126
■ 8.6.1.1.5 Consistent and distinguishable formats	.....	8-126
□ 8.6.1.1.6 Location of displayed help	.....	8-126
■ 8.6.1.1.7 Highlighting critical information	.....	8-126
□ 8.6.1.1.8 Prompts	.....	8-126
□ 8.6.1.1.9 Experienced users	.....	8-126
□ 8.6.1.1.10 Printing help information	.....	8-126
■ 8.6.1.1.11 Searching on-line help	.....	8-126
□ 8.6.1.1.12 User annotations	.....	8-127
□ 8.6.1.1.13 User requests	.....	8-127
<b>8.6.1.2 Access and return</b>	.....	<b>8-127</b>
□ 8.6.1.2.1 Access from and return to application	.....	8-127
□ 8.6.1.2.2 Reminder of accessibility	.....	8-127
□ 8.6.1.2.3 Notification of unavailability of help	.....	8-127
□ 8.6.1.2.4 Standard action	.....	8-127
□ 8.6.1.2.5 Consistent access	.....	8-127
□ 8.6.1.2.6 Easy access	.....	8-127
■ 8.6.1.2.7 Help command	.....	8-127
□ 8.6.1.2.8 Easy alternation between help display and original display	.....	8-127
□ 8.6.1.2.9 Easy return	.....	8-127
□ 8.6.1.2.10 Printing help information	.....	8-127
■ 8.6.1.2.11 Single action	.....	8-127
□ 8.6.1.2.12 Marketing topics for retrieval	.....	8-128
□ 8.6.1.2.13 Synonyms	.....	8-128

<b>8.6.1.3 Context sensitivity</b>	.....	<b>8-128</b>
■ 8.6.1.3.1 Task-oriented help	.....	8-128
□ 8.6.1.3.2 Ambiguous context	.....	8-128
□ 8.6.1.3.3 Context information in help display	.....	8-128
□ 8.6.1.3.4 List valid entries	.....	8-128
□ 8.6.1.3.5 Historical context	.....	8-128
<b>8.6.1.4 Wording and style</b>	.....	<b>8-128</b>
■ 8.6.1.4.1 Applicable criteria and guidelines	.....	8-128
□ 8.6.1.4.2 Wording	.....	8-128
■ 8.6.1.4.3 Appropriate to user	.....	8-128
<b>8.6.1.5 Count</b>	.....	<b>8-128</b>
□ 8.6.1.5.1 Scope	.....	8-128
□ 8.6.1.5.2 Only relevant information	.....	8-129
□ 8.6.1.5.3 Multilevel help	.....	8-129
□ 8.6.1.5.4 Help on Help	.....	8-129
■ 8.6.1.5.5 Titles	.....	8-129
□ 8.6.1.5.6 System information	.....	8-129
□ 8.6.1.5.7 Application information	.....	8-129
□ 8.6.1.5.8 Available commands	.....	8-129
□ 8.6.1.5.9 Command examples	.....	8-129
□ 8.6.1.5.10 Command format	.....	8-129
□ 8.6.1.5.11 Function keys	.....	8-129
□ 8.6.1.5.12 Prompts, requests, and definitions	.....	8-129
□ 8.6.1.5.13 Error messages	.....	8-129
□ 8.6.1.5.14 Shortcuts	.....	8-130
□ 8.6.1.5.15 Help index	.....	8-130
□ 8.6.1.5.16 Finding Help topics	.....	8-130
<b>8.7 Data communication</b>	.....	<b>8-130</b>
<b>8.7.1 User control and procedures</b>	.....	<b>8-130</b>
■ 8.7.1.1 Integration with other system functions	.....	8-130
■ 8.7.1.2 Consistent procedures	.....	8-130
■ 8.7.1.3 Minimal memory load	.....	8-130
■ 8.7.1.4 Explicit user actions	.....	8-130
□ 8.7.1.5 User control	.....	8-130
□ 8.7.1.6 Interruptable by user	.....	8-130
■ 8.7.1.7 Annotations to transmitted data	.....	8-130
<b>8.7.2 Preparing messages</b>	.....	<b>8-131</b>
<b>8.7.2.1 General</b>	.....	<b>8-131</b>
■ 8.7.2.1.1 Applicable criteria and guidelines	.....	8-131
□ 8.7.2.1.2 Printing messages	.....	8-131

<b>8.7.2.2 User control</b>	.....	<b>8-131</b>
□ 8.7.2.2.1 Length of messages	.....	8-131
□ 8.7.2.2.2 What can be transmitted	.....	8-131
□ 8.7.2.2.3 Saving prepared messages	.....	8-131
<b>8.7.2.3 Message format</b>	.....	<b>8-131</b>
□ 8.7.2.3.1 User-designed format	.....	8-131
■ 8.7.2.3.2 Application-supplied format	.....	8-131
<b>8.7.3 Addressing messages</b>	.....	<b>8-131</b>
<b>8.7.3.1 User control</b>	.....	<b>8-131</b>
□ 8.7.3.1.1 User-specified destinations	.....	8-131
□ 8.7.3.1.2 Editing address fields	.....	8-131
□ 8.7.3.1.3 Listing other users on-line	.....	8-131
<b>8.7.3.2 Message formatting</b>	.....	<b>8-132</b>
□ 8.7.3.2.1 Message header fields	.....	8-132
□ 8.7.3.2.2 Prompting	.....	8-132
<b>8.7.3.3 Directories and distribution lists</b>	.....	<b>8-132</b>
□ 8.7.3.3.1 On-line directories	.....	8-132
□ 8.7.3.3.2 Substitute addresses	.....	8-132
□ 8.7.3.3.3 User-defined distribution lists	.....	8-132
<b>8.7.3.4 Validation and error correction</b>	.....	<b>8-132</b>
□ 8.7.3.4.1 Valid address	.....	8-132
□ 8.7.3.4.2 Error correction	.....	8-132
<b>8.7.4 Initiating transmission</b>	.....	<b>8-132</b>
<b>8.7.4.1 System control</b>	.....	<b>8-132</b>
□ 8.7.4.1.1 Automatic queuing of outgoing messages	.....	8-132
□ 8.7.4.1.2 Appended information	.....	8-133
<b>8.7.4.2 User control</b>	.....	<b>8-133</b>
□ 8.7.4.2.1 User initiation of data transmission	.....	8-133
□ 8.7.4.2.2 What users can transmit	.....	8-133
□ 8.7.4.2.3 User-assignable priority	.....	8-133
□ 8.7.4.2.4 User-specified delivery	.....	8-133
□ 8.7.4.2.5 Notification of transmission and delivery	.....	8-133
□ 8.7.4.2.6 Cancellation of undelivered messages	.....	8-133

<b>8.7.5 Controlling transmission</b>	.....	<b>8-133</b>
<b>8.7.5.1 System control</b>	.....	<b>8-133</b>
□ 8.7.5.1.1 Transmitted message log	.....	8-133
<b>8.7.5.2 User control</b>	.....	<b>8-133</b>
□ 8.7.5.2.1 User-specified feedback	.....	8-133
□ 8.7.5.2.2 Cancellation of messages after initiation	.....	8-133
<b>8.7.5.3 Transmission failure</b>	.....	<b>8-134</b>
□ 8.7.5.3.1 Automatic queuing	.....	8-134
□ 8.7.5.3.2 Transmission failure	.....	8-134
<b>8.7.6 Receiving messages</b>	.....	<b>8-134</b>
<b>8.7.6.1 System control</b>	.....	<b>8-134</b>
□ 8.7.6.1.1 Incoming message queuing	.....	8-134
□ 8.7.6.1.2 Incoming message log	.....	8-134
<b>8.7.6.2 User control</b>	.....	<b>8-134</b>
□ 8.7.6.2.1 User control of incoming messages	.....	8-134
□ 8.7.6.2.2 User control of notification of incoming messages	.....	8-134
□ 8.7.6.2.3 Naming and describing incoming messages	.....	8-134
□ 8.7.6.2.4 Disposing of incoming messages	.....	8-134
<b>8.7.6.3 User review of messages</b>	.....	<b>8-134</b>
□ 8.7.6.3.1 User specification of summary order	.....	8-134
□ 8.7.6.3.2 User review of summary information	.....	8-134
□ 8.7.6.3.3 Nondestructive review	.....	8-135
■ 8.7.6.3.4 Applicable criteria and guidelines	.....	8-135
□ 8.7.6.3.5 Annotating incoming messages	.....	8-135
□ 8.7.6.3.6 Size indication	.....	8-135
<b>8.7.6.4 Incompatible data format</b>	.....	<b>8-135</b>
■ 8.7.6.4.1 Data preservation	.....	8-135
□ 8.7.6.4.2 Notification of incompatible format	.....	8-135
<b>8.7.6.5 Notification of incoming messages</b>	.....	<b>8-135</b>
□ 8.7.6.5.1 Notification at log on	.....	8-135
■ 8.7.6.5.2 Noninterfering notification	.....	8-135
□ 8.7.6.5.3 Priority of incoming messages	.....	8-135

<b>8.7.6.6 Replying to a message</b>	.....	<b>8-135</b>
□ 8.7.6.6.1 Automatic addressing of replies	.....	8-135
<b>8.8 Input devices</b>	.....	<b>8-136</b>
<b>Exhibit 8.8</b> Advantages and disadvantages of non-keyboard input devices	.....	8-136
<b>8.8.1 Keyboards</b>	.....	<b>8-138</b>
■ 8.8.1.1 When to use	.....	8-139
■ 8.8.1.2 Numeric keypads	.....	8-139
■ 8.8.1.3 VDT keyboard layout and features	.....	8-139
□ 8.8.1.4 Standard keyboards	.....	8-139
■ 8.8.1.5 Cursor movement keys	.....	8-139
<b>Exhibit 8.8.1.5</b> Cursor movement keys	.....	8-139
■ 8.8.1.6 Changing data	.....	8-139
□ 8.8.1.7 Keyboard equivalents to function keys	.....	8-139
□ 8.8.1.8 Keyboard equivalents to pointing device operations	.....	8-139
<b>8.8.2 Fixed-function keys</b>	.....	<b>8-140</b>
□ 8.8.2.1 Standardization	.....	8-140
□ 8.8.2.2 Availability	.....	8-140
□ 8.8.2.3 Nonactive keys	.....	8-140
■ 8.8.2.4 Grouping	.....	8-140
<b>8.8.3 Pointing devices</b>	.....	<b>8-140</b>
<b>8.8.3.1 General</b>	.....	<b>8-140</b>
■ 8.8.3.1.1 Functionality	.....	8-140
■ 8.8.3.1.2 Single pointer	.....	8-140
■ 8.8.3.1.3 Moving the pointer	.....	8-140
■ 8.8.3.1.4 Nondisappearance of pointer	.....	8-140
□ 8.8.3.1.5 Control of the pointer	.....	8-141
■ 8.8.3.1.6 Pointer stability	.....	8-141
□ 8.8.3.1.7 Movement ratio	.....	8-141
□ 8.8.3.1.8 Type of device	.....	8-141
<b>8.8.3.2 Mouse</b>	.....	<b>8-142</b>
□ 8.8.3.2.1 Use	.....	8-142
■ 8.8.3.2.2 Dynamic characteristics	.....	8-142
■ 8.8.3.2.3 Easily moved	.....	8-142
■ 8.8.3.2.4 Lateral range	.....	8-142

<b>8.8.3.3 Joystick and trackball</b>	.....		<b>8-142</b>
<b>8.8.3.4 Light pen</b>	.....		<b>8-143</b>
<b>8.8.3.5 Stylus and grid</b>	.....		<b>8-143</b>
<b>8.8.3.6 Pointer shapes</b>	.....		<b>8-144</b>
<b>8.8.3.7 Pointing device buttons</b>	.....		<b>8-146</b>
<b>8.8.4 Alternative input devices (non-keyboard, non-pointing devices)</b>	.....		<b>8-146</b>
<b>8.8.4.1 General</b>	.....		<b>8-146</b>
<b>8.8.4.2 Touch panels</b>	.....		<b>8-147</b>

■ 8.8.4.2.3 Luminance transmission .....	8-147
■ 8.8.4.2.4 Positive indication .....	8-147
■ 8.8.4.2.5 Dimensions and separation .....	8-147
<b>Exhibit 8.8.4.2.5</b> Touch panel responsive area dimensions .....	8-148
■ 8.8.4.2.6 Resistance .....	8-147
■ 8.8.4.2.7 Display feedback .....	8-148
<b>8.8.4.3 Voice control .....</b>	<b>8-148</b>
□ 8.8.4.3.1 Phonetically distinct vocabulary .....	8-148
■ 8.8.4.3.2 Easy error correction .....	8-148
■ 8.8.4.3.3 Alternative entries .....	8-148
<b>8.8.5 Interchangeability among input devices .....</b>	<b>8-149</b>
□ 8.8.5.1 Redundant control .....	8-149
<b>8.9 Accommodating people with disabilities .....</b>	<b>8-149</b>
<b>8.9.1 General .....</b>	<b>8-151</b>
□ 8.9.1.1 Equal access .....	8-151
□ 8.9.1.2 Equal computing capability .....	8-151
□ 8.9.1.3 Support in manipulating data .....	8-151
<b>8.9.2 Accommodating people with moderate physical disabilities .....</b>	<b>8- 151</b>
□ 8.9.2.1 Multiple, simultaneous activities .....	8-151
□ 8.9.2.2 Timed responses .....	8-152
□ 8.9.2.3 "Pointing" from the keyboard .....	8-152
□ 8.9.2.4 Cursor control devices .....	8-152
□ 8.9.2.5 Minimal number of "small" targets .....	8-152
□ 8.9.2.6 Handling insertable and removable parts .....	8-152
□ 8.9.2.7 Controls and latches .....	8-152
□ 8.9.2.8 Avoiding inadvertent operation .....	8-152
<b>8.9.3 Accommodating people with severe physical disabilities .....</b>	<b>8- 152</b>
□ 8.9.3.1 Connection point for alternative output devices .....	8-153



<b>8.9.4</b>		
<b>Accommodating</b>		
<b>people with visual</b>		
<b>disabilities</b>	.....	<b>8-153</b>
	□ 8.9.4.1 Enlarging a display .....	8-153
	□ 8.9.4.2 Selecting display colors .....	8-153
	□ 8.9.4.3 Readability of lettering on keys and controls .....	8-153
<b>8.9.5</b>		
<b>Accommodating</b>		
<b>people who are blind</b>	.....	<b>8-153</b>
	□ 8.9.5.1 Connection point for alternative output devices .....	8-153
	□ 8.9.5.2 Alternatives to input devices .....	8-154
	□ 8.9.5.3 Nonvisual indication of state of toggle keys .....	8-154
	□ 8.9.5.4 Key demarcation .....	8-154
	□ 8.9.5.5 Identification of "home" keys .....	8-154
	□ 8.9.5.6 Key labels .....	8-154
<b>8.9.6</b>		
<b>Accommodating</b>		
<b>people with hearing</b>		
<b>disabilities</b>	.....	<b>8-154</b>
<b>8.9.6.1 General</b>	.....	<b>8-154</b>
	□ 8.9.6.1.1 Redundant visual output .....	8-154
	□ 8.9.6.1.2 Hearing auditory outputs .....	8-154
<b>8.9.6.2 Auditory screen</b>		
<b>representation</b>	.....	<b>8-155</b>
	□ 8.9.6.2.1 Granularity .....	8-155
	□ 8.9.6.2.2 Navigation .....	8-155
	■ 8.9.6.2.3 Hear and feel consistency .....	8-155
	□ 8.9.6.2.4 Dual representation .....	8-155
	□ 8.9.6.2.5 Objects represented .....	8-156
	□ 8.9.6.2.6 Nonoverlapping objects .....	8-156
	□ 8.9.6.2.7 Eliciting an object's name .....	8-156
	□ 8.9.6.2.8 Size and location of objects .....	8-156
<b>8.9.7</b>		
<b>Accommodating</b>		
<b>people who have</b>		
<b>seizure disorders</b>	.....	<b>8-156</b>
	□ 8.9.7.1 Avoiding flashing-induced seizures .....	8-156

**8.9.8****Accommodating  
assistive devices**

.....	<b>8-156</b>
□ 8.9.8.1 Electronic documentation .....	8-156
□ 8.9.8.2 Speech output compatibility .....	8-157
□ 8.9.8.3 Special display window .....	8-157
□ 8.9.8.4 Connection point for switches .....	8-157
□ 8.9.8.5 Distinguishing macro input from typed input .....	8-157
□ 8.9.8.6 Keyguards .....	8-157



## 8 Human-computer interfaces

This section contains criteria and guidelines governing human-computer interfaces. The topics covered include: (1) modes of human-computer interaction, (2) basic screen design, (3) windowing, (4) data entry, (5) data display, (6) user guidance, (7) data communication, (8) input devices, and (9) accommodating people with disabilities.

### 8.1 User-computer interaction

Interaction between a user and a computer is a two-way communication process; the user issues a command, and the computer responds. Two terms are commonly used to designate this process, "sequence control" and "interactive control." This HFDG uses the latter.

A series of commands and responses is called a "dialog." There are eight major types of dialogs: (1) question and answer, (2) language, (6) query language, (7) natural language, and (8) direct manipulation. The types are not exclusive, rather they are often used in combination, for example, windowing systems tend to use a combination of menu selection and direct manipulation.

**Definitions.** A **transaction** is a user action paired with an associated computer response (or vice versa). It is the smallest unit of user-computer interaction. A **dialog** is a structured series of transactions.

#### 8.1.1 General

- **8.1.1.1 Consistent control actions.** Interactive control actions should be consistent in form, means, and consequence from one transaction to another, from one task to another, and from one application to another.

**Discussion.** This guideline is extremely important for users of multiple applications. For example, if a user of a system being designed or selected must control several diverse operating systems or inconsistent control functions, then high error rates, extensive training, and low human reliability may be a consequence.

- **8.1.1.2 System matched to user abilities.** Interactive control systems should be adaptable to individual differences and should accommodate the variety of user abilities expected, whether novice or expert. If applicable, systems and applications should provide relatively helpful or self-explanatory operations for novice or infrequent users, and relatively efficient operations for experienced users.
- **8.1.1.3 User control.** The user-computer interaction should give users the feeling that they control the system, not that the system controls them.

- **8.1.1.4 User control of pace.** The user, not the computer, shall control the pace of control entries by explicit actions.
- **8.1.1.5 Explicit user control.** A user shall complete a control entry or action through an explicit action, such as pressing the **Enter** key; the system shall not interrupt the user's actions to indicate that it recognizes the command.

**Exceptions.** Certain exceptions to this rule are given in the following instances. For example, expert users of a windowing system may prefer implicit control when assigning focus to a window. That is, their action of moving the cursor into a window automatically makes it the active window. Also, expert users entering very structured data may work more efficiently if the application supports auto-tabbing between fields.

- **8.1.1.6 Simplicity.** Interactive control shall be simple, flexible, and adaptive, as well as consistent and compatible with the lowest anticipated user skill level. Interactive control shall be logical in terms of user task sequences and functions.
- **8.1.1.7 Minimal user actions.** Interactive control logic should permit completion of a task with the minimum number of actions, consistent with user abilities.
- **8.1.1.8 No repetitive entry of information.** If the same information is required for more than one transaction in the same application, the user should only supply it once; the application should supply it automatically thereafter.
- **8.1.1.9 User perspective.** A sequence of transactions should be designed to be logical from the perspective of the user, not from the perspective of computer processing or ease of programming.
- **8.1.1.10 Transaction wording.** The wording used in a transaction shall be consistent with the user's frame of reference and with the wording used in user guidance.
- **8.1.1.11 User expectations.** The result of any correct control entry should be compatible with a user's expectations.
- **8.1.1.12 Minimal memory load.** The short-term memory requirements on users should be minimized by such means as making displays and interactive sequences self-evident and by providing on-line help and tutorials.
- **8.1.1.13 Customized interaction.** If practical, users should be able to customize the information displayed and the control options available to match their individual needs. This ability should not be provided if users share systems or applications in a way that would allow one user's customization to negatively affect or impact another user.

- **8.1.1.14 Multiple users.** If a system or application can be used by more than one user at the same time, control actions by any user shall not interfere with those of any other user.

**Exception.** An exception to this rule is when real-time group interaction, such as shared document editing, in which only one user at a time may interact with the document, and other users are unable to access it during that time.

- **8.1.1.15 Paging and scrolling.** If a display shows only part of the data currently available for display, the system or application shall provide paging, scrolling, or both.

**Definitions.** Scrolling is a method used to move through the contents of a window or list in a dialogue box using the scroll bar or scroll arrows. Paging is process of scrolling through data one page at a time.

- **8.1.1.16 Upper-lower case equivalence.** In interpreting user-generated control entries, the system or application should treat upper and lower case letters as equivalent.
- **8.1.1.17 Canceling or undoing actions.** User actions should be easy to cancel or undo (see paragraph 8.2.1.7).
- **8.1.1.18 Names of control functions.** The names of interactive control functions should be semantically congruent with natural usage, especially for paired opposites. For example, if **Up** is the command to move the cursor up, the opposite command would be **Down**, not **Lower**.
- **8.1.1.19 Closure.** The sequence of user actions and computer responses that accomplishes a task should be designed to give the user a sense of completion or closure at the end. Not only does this give the user a sense of accomplishment, but it lets him or her know when to go on to another task.
- **8.1.1.20 Interactive paradigm.** Applications should base their interactions on an object-action paradigm, that is, a user first selects an object, then specifies an action.

**Discussion.** The objects selected may be controls, text entities, or graphic entities. More than one object may be selected.

- **8.1.1.21 User control.** Users should control the pace of the interaction with an application. The application should initiate an action only in response to an explicit user input. If appropriate, users should be able to specify when a process occurs, and they should be able to interrupt or terminate a process.
- **8.1.1.22 Immediate feedback.** Users should receive an immediate, visible response to every action.

**Discussion.** If the result of the action is not immediate, some other visible response may be made. For example, a button selected might be highlighted, the pointer might change shape, or a message might be displayed.

- **8.1.1.23 Visual cues.** An application should inform users when they can and when they cannot take an action by providing visual cues indicating when it can accept input, when it is momentarily unavailable, and when it is unavailable during extended processing.
- **8.1.1.24 Prompts.** If a user must perform several actions to complete a task, the application should prompt the user with the actions that need to be performed.
- **8.1.1.25 Ignoring user actions.** An application should ignore user actions (except for user interrupts) made during periods of time when input cannot be accepted. It should disable the pointing device and keyboard when input might have destructive effects. User inputs made during processing by the application should not be stored for execution after processing is completed. While users should not be able to override disabling, users should be able to stop a process if desired (see section 8.1.3.3).
- **8.1.1.26 Error detection.** If a user attempts to initiate an invalid action, the application should display a message stating that the action is invalid and should not initiate the action. If the attempted action is part of a series of actions, the user should only have to correct the invalid action; he or she should not have to repeat the entire sequence of actions.
- **8.1.1.27 Confirmed destruction.** Applications shall be designed so that users must confirm any destructive action that cannot otherwise be reversed or "undone."

## 8.1.2 System response time

In designing any application, response time is critical. The response of an application is dependent on hardware and other processes requiring central processor unit (CPU) use. For example, a multitasking system may be slowed by other concurrent applications and therefore, is hard to quantify. Thus, the rules in this section need to take into account such factors.

- **8.1.2.1 Appropriate system response time.** The response time of a system to a user action shall be appropriate to the type of transaction, the time constraints of the task, and any specific data processing requirements. Responses to menu selections, function key presses, and most entries during graphic interaction shall appear to a user to be immediate. Other response times shall match the user's perception of the complexity of the transaction, with apparently simpler transactions having faster responses.
- **8.1.2.2 Maximum system response times.** System response times shall not exceed the values given in exhibit 8.1.2.2 for the system tasks listed.

**Exhibit 8.1.2.2** Maximum system response times for routine system tasks

<b>System interpretation</b>	<b>Response time definition</b>	<b>Maximum response time (sec)</b>
Key response	From key depression until positive response, for example, "click" or display echo	0.1
Key print (echo)	From key depression until appearance of character	0.2
Page turn	From end of request until first few lines are visible	1.0
Page scan	From end of request until text begins to scroll	0.5
Data field entry	From selection of field until visual verification	0.2
Function selection	From selection of command until response	2.0
Pointing	From input of point to display of point or pointing device	0.2
Drawing, sketching	From input of point to display of point, line, arc, etc.	0.2
Local update	Change to image or display using local data base, for example, new menu list display	0.5
Host update	Change where data are at host in a readily accessible form, for example, a display scale change	2.0
File update	Image or display update requiring access to a host file	10.0
Simple inquiry	From command until display of a common message	2.0
Complex inquiry	Response message that requires seldom used calculations in graphic form	10.0
Error feedback	From entry of input until error message appears	2.0

- **8.1.2.3 Variability of system response time.** The variability of system response times for processing various types of control actions shall be minimized. For processing in the range of 0 to 2 sec, variability shall not exceed 5 percent; for processing in the range 2 to 5 sec, variability shall not exceed 10 percent; for processing longer than 5 sec, variability shall not exceed 15 percent.
- **8.1.2.4 Acknowledgement of delayed processing.** If the processing of a control entry must be delayed because of computer processing of a prior entry or entries, the current control entry shall be acknowledged.



- **8.1.2.5 Notification of display completion.** If the generation of a display is time consuming, and if it is not otherwise obvious, the system shall notify the user when the display is complete.
- **8.1.2.6 Response-time-induced keyboard lockout.** If application processing prohibits acceptance of keyboard input and no keyboard buffer is available, the application should lockout the keyboard until the application can accept input.

**Definition. Keyboard lockout** is a state determined by an application in which the application does not accept input from the keyboard.

- **8.1.2.7 Lockout duration.** Temporary lockout of a keyboard or other device due to processing of a transaction control entry shall be minimized.
- **8.1.2.8 Lockout indication.** If an application incorporates keyboard lockout, it shall provide a clear indication to users when the keyboard is locked out and when it is not. One way this might be done is to change the shape of the cursor or pointer to a watch or hourglass.
- **8.1.2.9 Lockout override.** An application that incorporates keyboard lockout should also provide a means for overriding the lockout, for example, by assigning a function key to have this effect. If lockout override is provided and it is invoked, the system should not reset and lose any processing that was completed before the override was invoked.

### 8.1.3 System-initiated information

#### 8.1.3.1 Prompting

- **8.1.3.1.1 Prompting.** A system or application shall (1) prompt users for all required input parameters, (2) request additional or corrected information as needed, (3) provide orientation (as to the computer's processes to users) during transactions, and (4) indicate any errors that are detected.
- **8.1.3.1.2 Prompt contents.** If the computer is waiting for input from a user, it shall indicate clearly where on the screen the input is expected and, to the extent possible, what information is expected.
- **8.1.3.1.3 Location of prompts.** Prompting messages shall appear in a consistent location on the screen, for example, at the beginning of the next line to be typed, in the data field where an entry is to be made, at a command input line, or within a menu window from which a selection is to be made.
- **8.1.3.1.4 Duration of prompts.** If a computer requests information from a user, any instructions about how to supply the

information should remain visible until the user complies or takes some other action.

- **8.1.3.1.5 User-selected level of prompting detail.** A system or application should permit users to select the level of detail they want in prompts. This capability should not be provided if the system or application is shared in a way that would allow one user's selection to affect another user.

### 8.1.3.2 Feedback

- **8.1.3.2.1 Entry acknowledgement.** Every user action shall result in a response from the system. This response shall not exceed the maximum time intervals presented in Exhibit 8.2.16.2.
- **8.1.3.2.2 Periodic feedback.** If the system takes more than 2 seconds to respond, it shall provide periodic feedback to the user indicating that normal operation is occurring (see paragraph 8.2.7.2).
- **8.1.3.2.3 Periodic feedback messages.** Successive periodic feedback messages should differ in wording from presentation to presentation, or be otherwise indicated. For example, three successive messages might be: (1) "Processing search -- please wait." (2) "Search continuing -- please wait." (3) "Processing search -- wait please."
- **8.1.3.2.4 Completion of processing.** If the computer response to a user action is lengthy, the computer shall give a clear and positive indication when processing is complete.

### 8.1.3.3 System-initiated interrupts

- **8.1.3.3.1 System interrupts.** A system or application shall interrupt a user only when necessary to prompt the user for a response, to provide essential feedback, or to inform the user of errors.
- **8.1.3.3.2 "Working" indication.** If a system or application takes more than 2 seconds to complete an operation initiated by a user action, and during this time it is incapable of accepting further input from the user, it shall inform the user that action is continuing. For example, the system might display a "working" message, or a symbol such as a watch or an hourglass (see exhibit 8.8.3.6.1).

**Discussion.** A dynamic aspect to the "working" message is highly desirable. For example, the message might display the percent of processing that has been completed or that remains, with the percentage updated regularly. If this is not possible, a display that changes with time is still desirable, for example, a row of dots, with a new dot added periodically.

### 8.1.3.4 Status information

- **8.1.3.4.1 Availability of status information.** Information about the current status of the system should be available to users at all times. As appropriate to the system, this information should be provided automatically or upon user request.

**Discussion.** System status information might include information about data processing status, system availability, operational mode, system load, other users, and external systems.

- **8.1.3.4.2 Status of alarm settings.** Users should be able to obtain status information concerning current alarm settings, for example, the dimensions or variables covered and the values or categories established as critical.
- **8.1.3.4.3 Status of other systems or users.** If interaction with other systems or users is required, status information about the other systems or users should be available.

### 8.1.3.5 Alarms

- **8.1.3.5.1 Distinctive and consistent alarms.** Alarm signals and messages shall be distinctive and consistent for each class of event, for example, a signal alerting a user to an incoming message would be different from a signal alerting a user to a hazardous condition.
- **8.1.3.5.2 Acknowledging and terminating alarms.** A system or application shall provide users a means of acknowledging critical and noncritical alarms, and of turning off alarm signals once the alarms have been acknowledged or the condition generating the alarm has been corrected. Procedures for acknowledgment and termination shall not decrease the speed and accuracy of operator reaction to the alerting situation.
- **8.1.3.5.3 Feedback about alarms and alerts.** Users shall be provided informative feedback for actions that trigger alarms and alerting signals. If necessary, users shall be able to request help and related information for the operation and processing of critical and noncritical alarms, messages, and signals.
- **8.1.3.5.4 Special acknowledgement of critical alarms.** If a user must acknowledge a special or critical alarm in a unique way, for example, with a special combination of key strokes, this special acknowledgement shall not inhibit or slow the response to the condition initiating the alarm.
- **8.1.3.5.5 Alarm reset.** A system or application shall provide users with a simple means for turning off an auditory alarm without erasing any displayed message that accompanies the auditory signal.

- **8.1.3.5.6 User setting of alarm parameters.** If appropriate to the task, a system or application should allow a user to set the parameter or condition that results in a software-generated alarm, alert, or status message. Some examples of parameters or conditions are priorities, percentages, and absolute values or ranges of values. User setting of parameters should not be allowed if: (1) the settings by one user might affect the reception of alarms by another user, (2) the settings might affect the safety of systems, equipment, or personnel, or (3) alarm parameters are determined by functional, procedural, or legal requirements.

### 8.1.3.6 Routine messages

- **8.1.3.6.1 Routine feedback.** The system shall provide users consistent, routine feedback regarding such activities as control entries, computer processing, and print requests.
- **8.1.3.6.2 User control.** If appropriate, users should be able to specify the level or type of system message they want to receive.
- **8.1.3.6.3 Clarity of purpose.** The wording of routine messages should make clear to the user that they provide status or feedback information, not that they indicate errors or requests for a user action.

### 8.1.4 User-initiated interrupts

- **8.1.4.1 User interruption of transactions.** A system or application shall permit a user to interrupt or terminate the current transaction. Each type of interrupt shall have a separate control option and a distinct name. The following types of interrupts may be provided: **Cancel, Escape, Backup, Restart, Abort, Stop, Pause-Continue, and Suspend.**
- **8.1.4.2 Stored or entered data.** User interruptions shall not change or remove stored or entered data, with the exception of the Cancel interrupt.
- **8.1.4.3 Backup (or Go-back).** A nondestructive **Backup** or **Go-back** option shall be provided to return the display to the last previous transaction.
- **8.1.4.4 Cancel (or Undo).** If appropriate, a system or application shall provide a **Cancel** or **Undo** option that will erase changes just made by a user and restore the current display to its previous state.
- **8.1.4.5 End, Exit, or Stop.** If appropriate, a system or application shall provide an **End, Exit, or Stop** option to conclude a repetitive transaction sequence.
- **8.1.4.6 Pause and Continue.** If appropriate, a system or application shall provide **Pause** and **Continue** options that will

interrupt and later resume, respectively, a transaction sequence without any change to data entries or control logic for the interrupted transaction.

- **8.1.4.7 Indicating Pause status.** If a **Pause** option is provided and selected, the system or application shall provide an indication that the transaction sequence has been halted. The system or application shall prompt the user to select **Continue** to resume the interrupted sequence.
- **8.1.4.8 Restart (or Revert).** If appropriate, a system or application shall provide a **Restart** or **Revert** option that will cancel entries made in a defined transaction sequence and will return the user to the beginning of the sequence. If a restart will result in the loss of data or changes, the system shall require a confirming action by the user.
- **8.1.4.9 Review.** If appropriate, a system or application shall provide a nondestructive **Review** option that will return to the first display in a defined transaction sequence, permitting the user to review a sequence of entries and make necessary changes.
- **8.1.4.10 Suspend.** If appropriate, a system or application shall provide a **Suspend** option that permits a user to preserve the current state of a transaction while leaving the system and to resume the transaction at a later time.
- **8.1.4.11 Indicating Suspended status.** If a system or application provides a **Suspend** option, it shall display an indication that a transaction has been suspended whenever the option has been selected. The system shall prompt the user with information on how to resume the suspended transaction at his or her next log on. For example, the user might see: "Type **Exit** to return to application."

## 8.1.5 Error management

### 8.1.5.1 General

- **8.1.5.1.1 User-detected errors.** A user should be able to stop a control process at any point in a sequence to correct an error.
- **8.1.5.1.2 Appropriate response to all entries.** A system or application shall provide an appropriate response to all possible control entries, correct and incorrect. For example, the selection of an incorrect function key might result in a message listing the appropriate selections.
- **8.1.5.1.3 System detection of error type.** A system or application should be able to distinguish among program errors, equipment failures, and operator errors and, if a failure results in a shutdown, allow for minimum loss of work performed.

- **8.1.5.1.4 Fast error detection.** User errors should be detected and reported by the system as soon as possible, so that they are easier to correct.
- **8.1.5.1.5 Immediate data correction.** If a user has completed a data entry transaction and an error is detected, the user shall be able to make corrections directly and immediately.
- **8.1.5.1.6 Prompting command correction.** If a system or application does not recognize an element of a command entry, the system should prompt the user to correct that element rather than require re-entry of the entire command.
- **8.1.5.1.7 Display duration.** Notices, alerts, and informational displays should remain visible to a user until he or she responds with an appropriate action.
- **8.1.5.1.8 Enter action for corrections.** A system or application shall require an explicit user action to re-enter corrected material after a user has completed correcting an error. The enter action for re-entry shall be the same as the enter action for the original entry.
- **8.1.5.1.9 Return to main interaction.** A system or application shall provide an easy means to return to the main dialog after error correction.
- **8.1.5.1.10 User confirmation of destructive actions.** If a control entry (including log off) will result in a change in stored data, procedures, or system operation, particularly if it is not easily reversible, the system or application shall notify the user and require a confirmation of the action before implementing the action. The notification shall explicitly warn the user of potential loss of data. The **Enter** key shall not be used for the confirmation action.
- **8.1.5.1.11 Flexible "go back" for error correction.** A system or application shall allow a user to go back easily to previous steps in a transaction sequence in order to correct an error or make any other desired change.
- **8.1.5.1.12 Undo control action.** A system or application shall provide an Undo operation that immediately reverses the last previous control action.
- **8.1.5.1.13 Error recovery.** All conditions and information relevant for user recovery from an error shall be displayed to the user. Users shall be able to correct the error immediately. Error messages and error feedback about the data or control entry shall be given within 2 seconds of the time the error is detected.

## 8.1.5.2 Error messages

- **8.1.5.2.1 System-detected need for help.** To the extent practicable, a system or application should detect inappropriate user entries and actions, automatically interrupt the task, and

either suggest an appropriate entry or action or ask the user to confirm or clarify his or her intentions.

**Examples.** The system might provide a message when it detects an error, an out-of-range response, a missing parameter, a duplicated entry, or an unusually long pause on the part of the user.

- **8.1.5.2.2 Confirmation messages.** If a user entry might cause the loss or destruction of data or a disruption of a system, the system shall display a cautionary message and require that the user confirm the entry. This includes logging off the system (see also paragraph 8.3.10.2.10).
- **8.1.5.2.3 Multilevel messages.** If appropriate, the system shall provide more than one level of error messages, with successive levels providing increasingly detailed levels of explanation.
- **8.1.5.2.4 Multiple errors.** If a system detects multiple errors, it should describe the first error and inform the user of the total number of additional errors. The cursor should be moved to the location of the first error. If appropriate, the system should provide a means for the user to request sequential display of the additional error messages.
- **8.1.5.2.5 Nondisruptive error messages.** The display of error messages should not disrupt ongoing user activity, for example, an error message should not be displayed until a user has completed an entry. In general, error messages should be displayed within 4 seconds after the user completes the entry in which the error is detected.
- **8.1.5.2.6 Coding of warning messages.** Messages that require special user attention shall be coded appropriately and distinctively (see section 8.5.4).
- **8.1.5.2.7 Content of error messages.** If applicable, error messages should state the error detected, the input field containing the error, and the corrective action.
- **8.1.5.2.8 Wording of error messages.** Error messages shall be brief, specific, and task-oriented (see also section 10.2.3).
- **8.1.5.2.9 Tone of error messages.** In general, error messages should be worded as advice or suggestions.
- **8.1.5.2.10 Correcting errors.** If possible, after detecting an error, the system should prompt users to reenter only the portion of the entry or command that is in error. That is, users should not have to reenter the entire entry.
- **8.1.5.2.11 Cursor placement.** After an error message is displayed, the cursor shall be placed at the location of the entry in error.

- **8.1.5.2.12 Instructions and error messages.** Instructions and error messages shall appear in a consistent location on the screen (same as 8.2.1.2.4).

### 8.1.5.3 Command interaction errors

- **8.1.5.3.1 Command editing.** A system or application shall permit a user to edit an extended command during its composition, that is before taking an explicit Enter action.
- **8.1.5.3.2 Command correction prompting.** A system or application shall prompt a user to correct an element of a command entry that is not recognized or that is logically inappropriate. Whenever possible, the faulty command shall be retained in the command entry area of the display, with the cursor automatically positioned at the incorrect item, and with an advisory message displayed that describes the problem. The user shall not have to re-enter the entire line or command. The message shall make clear to the user what corrective action is required.
- **8.1.5.3.3 Unrecognized commands.** If a menu selection, function key, or command entry is invalid or inoperative at the time of selection, (for example, if a user attempts to print a document while in an editing mode), no action should result except the display of an advisory message. This message should tell the user what is wrong and which functions, options, or commands are appropriate.
- **8.1.5.3.4 Errors in stacked commands.** If an error is detected in a series of stacked command entries, the system shall operate consistently in one of the following modes: (1) execute commands up to the point of error, or (2) require the user to correct any errors before executing any of the commands.
- **8.1.5.3.5 Partial execution of stacked commands.** If only a portion of a stack of commands can be executed, the system or application shall notify the user and provide appropriate guidance to permit correction, completion, or cancellation of the inexecutable command.
- **8.1.5.3.6 Stacked command execution.** If the system detects an error in a stack of commands it is processing, it shall notify the user and promptly (within 4 sec) provide guidance to permit correction, completion, or cancellation of the stacked commands.

### 8.1.6 Transaction and control options

- **8.1.6.1 User-specified transaction timing.** If appropriate to task requirements, users shall be able to specify transaction timing. For example, users might be able to specify when a transaction starts, when it is completed, and the periodic scheduling of repeated transactions.



- **8.1.6.2 User memory load.** The number of mnemonics, codes, special or long sequences, and special instructions that users may need to learn shall be minimized.
- **8.1.6.3 Prompting control entries.** The system or application shall provide the user whatever information is required to guide control entries.

**Examples.** Prompts may be incorporated into a display at any point in a transaction sequence that will be helpful, or prompts may appear in response to a request for help. The selected prompts must be used consistently.

- **8.1.6.4 List of basic control options.** A list of basic control options that are always available to a user shall be easily displayable. This list can serve as a "home base" or starting point for control entries. An example is the system-level menu.
- **8.1.6.5 Appropriate specific options.** A list of the control options that are specifically appropriate for a particular transaction should be displayed in the working display or by user command.
- **8.1.6.6 Option wording.** The wording of control options should be task oriented, reflecting a user's view of the current transaction, for example, if users use the term "assign," the control option control option should also be **Assign**.
- **8.1.6.7 Option presentation.** The options presented in a list of basic options should be grouped, labeled, and ordered according to their: (1) logical function, (2) sequence, (3) frequency, or (4) criticality of use. If these ordering schemes are in conflict, default to the higher level order.
- **8.1.6.8 Option code display.** If users must select options by entering codes, the code associated with each option shall be displayed in a consistent manner and shall be distinct from other codes. If possible, the codes shall be intuitive.
- **8.1.6.9 Displaying control defaults.** If control is accomplished by keyed command or option code entries and a default entry is defined, the default shall be displayed to the user.
- **8.1.6.10 Initial cursor position for pointing devices.** If a user must select among displayed options using a pointing device, the cursor shall be placed on the default option when the display appears (same as paragraphs 8.1.11.7.2 and 8.4.1.6.4).

**Definition.** A **cursor** is a marker on the display screen that indicates the position where the computer expects the next input or will display the next output. The cursor may be positioned under computer control or by the user.

- **8.1.6.11 Initial cursor position for keyboards.** If a user must select among displayed options using a keyboard, the cursor shall be placed on the default option in the control entry area (with that

control entry area having implicit input focus) when the display appears (see "discussion" in paragraph 8.3.4.3.1) (same as paragraphs 8.1.11.7.3 and 8.4.1.6.5).

- **8.1.6.12 Consistent Continue option.** At any step in a defined sequence of transactions, if there is only a single appropriate next step, the system or application shall provide a consistent control option. For example, if data entry is involved, an explicit **Enter** or **Tab** control option signalling entry shall be used rather than a **Continue** or **Next** action.
- **8.1.6.13 Options at completion of a transaction.** A transaction should never leave a user without further available options and should provide next steps or alternatives, for example, **Continue**, **Abort**, or **Go to main directory**.
- **8.1.6.14 Command stacking.** A system or application should permit, but not require, a user to enter a sequence (or "stack") of command names, abbreviations, and option codes as a single stacked command. For example, a stack of commands might execute a complete task. Stacked commands must be entered in the same order that would be used if they were entered singly. If there is an error in a stack, the system or application should highlight the point of error and prompt the user for a correct entry.
- **8.1.6.15 Punctuation of stacked commands.** Required punctuation of stacked commands shall be minimized. A delimiter to separate commands shall be adopted and used consistently. For example, the slash (/) might be adopted as the delimiter, and a stacked command might be:  
**Sort/Save/Transmit.** If possible, the delimiter shall be as intuitive as possible by using an ampersand (&), a "plus" sign (+), or a comma (,).
- **8.1.6.16 User-defined stacks (macros).** A system or application should allow a user to define a series of graphical- or character-based control entries, assign the series a name (macro), and subsequently enter the series by simply entering that name.

## 8.1.7 Abbreviations

- **8.1.7.1 Abbreviations.** If a system or application uses abbreviations in its user-computer interface, the abbreviations shall be unique, distinct, and unambiguous. Their use shall not confuse users and shall not add to system operation time.

**Definition.** An **abbreviation** is any shortened form or abridgment of a word, expression, or phrase used to conserve space or time. Thus, the term abbreviation includes initializations and acronyms.

- **8.1.7.2 Use of abbreviations.** The use of abbreviations shall be minimized. If an abbreviation must be used for a term, the

abbreviation shall be selected or constructed by the first of the following methods that applies:

- a. by selecting the abbreviation from FAA Order 7340.1,
- b. by selecting the abbreviation from the U.S. Government Printing Office *Style Manual*,
- c. by constructing an abbreviation following the rules in the U.S. Government Printing Office *Style Manual*.

- **8.1.7.3 Definitions of abbreviations.** If a system or application uses abbreviations in its user-computer interactions, it shall provide an easy on-line, context-sensitive means for a user to learn the definition of an abbreviation.
- **8.1.7.4 New abbreviations.** If new abbreviations are needed, they shall be developed according to the rules of the U.S. Government Printing Office *Style Manual*.

### 8.1.8 Interaction method

- **8.1.8.1 Selection of interaction type.** The interaction type shall be selected to be appropriate to the task requirements, the characteristics of the system, and the abilities of the users. The appropriateness of the major types of interaction for these requirements, characteristics, and abilities are listed here and summarized in exhibit 8.1.8.1.
  - a. The **question and answer** interaction type is appropriate if:
    - (1) the task is routine data entry,
    - (2) the characteristics of the data are known and ordering can be constrained,
    - (3) users are expected to have little or no training, and
    - (4) computer response is expected to be moderately fast.
  - b. The **form filling** interaction type is appropriate if:
    - (1) flexibility in data entry is needed,
    - (2) users are expected to be moderately trained,
    - (3) computer response may be slow, and
    - (4) an aid in composing complex control entries would be helpful.

**Exhibit 8.1.8.1** Appropriateness of interaction types for various task requirements, system characteristics, and user abilities

Task, system characteristic user ability	Question and answer	Form filling	Menu selection	Function keys	Command language	Query language	Constrained natural language
Arbitrary control or data entry sequences					X		
Poorly defined or broad interface definition							X
Unpredictable information retrieval						X	X
Wide range of control entries					X		
Frequent transactions				X			
Small or constrained command choice set			X	X			
Complex control		X					
Large command set			X				
Routine data entry	X						
Entry order constrained	X						
Data entry flexibility needed		X					
Little arbitrary data input			X				
Slow computer response time		X					
Fast computer response time	X		X				
High training of users					X		
Moderate training of users		X				X	
Little or no training of users	X		X				X

- c. The **menu selection** interaction type is appropriate if:
- (1) tasks involve choices from constrained sets of alternatives,
  - (2) little entry of arbitrary data is required,
  - (3) users are expected to have little training,
  - (4) a command set is too large for users to remember, and
  - (5) computer response is relatively fast.

- d. The **function key** interaction type is appropriate for use in conjunction with other types if:
    - (1) tasks require only a limited number of control entries, or
    - (2) an immediate means for accomplishing frequent control entries or transactions is desirable.
  - e. The **command language** interaction type is appropriate if:
    - (1) tasks involve a wide range of control entries,
    - (2) users are expected to be highly trained or will use the system frequently, and
    - (3) control entries may be mixed with data entries in arbitrary sequence.
  - f. The **query language** interaction type is appropriate if:
    - (1) tasks emphasize unpredictable information retrieval, and
    - (2) users are expected to be highly trained.
  - g. The **constrained natural language** interaction type is appropriate if:
    - (1) task requirements are wide ranging or poorly defined, and
    - (2) users are expected to have moderate training.
  - h. The **direct manipulation** interaction type is appropriate when tasks mimic physical manipulation of concrete objects, such as positioning graphical objects, moving blocks of text, and resizing objects. It is also appropriate for casual system users and users expected to have little or no training.
- **8.1.8.2 Distinctive display of control information.** Displays shall be designed so that features such as prompts and messages relevant to the interactive method are distinctive in position and format.
  - **8.1.8.3 Hierarchical levels.** If hierarchical levels are used to control a process or sequence, the number of levels shall be minimized. Display and input formats shall be similar within levels, and the system shall indicate the current position within a sequence (see also paragraph 8.1.11.3.4).

### 8.1.9 Question-answer

- **8.1.9.1 Singular presentation of questions.** Questions shall be presented one at a time and shall not require the user to answer more than one question at a time. To the extent possible, users shall be provided a default or a list of the most appropriate responses from which they may select the desired response.
- **8.1.9.2 Display of interrelated answers.** If a system poses a series of questions to the user, and the answer to the current question is dependent upon how a previous question was answered, answers to all questions within the series should be displayed until all questions have been answered.
- **8.1.9.3 Sequence compatibility with source document.** If questions require entry of data from a source document, the question sequence shall match the data sequence within the source document.

### 8.1.10 Form-filling

- **8.1.10.1 Consistency.** The forms and formats of form-filling interactions shall be consistent and logical throughout an application and related applications.
- **8.1.10.2 Default entries.** Wherever possible, default entries shall appear in their fields when a form is displayed in form-filling interactions.
- **8.1.10.3 Default listing.** A default listing or screen shall be provided in which authorized users may view and change default settings of fields.
- **8.1.10.4 Other applicable sections.** In addition to the criteria and guidelines in this section, those of section 8.4, in particular section 8.4.2, shall also apply to form-filling interactions.

### 8.1.11 Menus and menu selection

The use of menus as an interaction method is widespread, often in conjunction with other methods, direct manipulation, in particular. Menus are usable with little or no training on the part of the user. If the meanings of the options are clear, the user can be guided step-by-step through an application. Menus do have some disadvantages, however; they can slow down an experienced user; they can occupy a considerable amount of display space; and, in complex sequences, users may become lost in the menu structure.

**Definitions.** A **menu** is a list of options from which a user makes a selection or selections. An **option** is one of the selectable items in a menu. **Selection** is the action a user makes in choosing a menu option. Selection may be accomplished by pointing, by typing, or by a pressing a function key.

### 8.1.11.1 General

- **8.1.11.1.1 Menu titles.** A menu shall describe or explain the options listed under it. The title shall be easily distinguished from the options.
- **8.1.11.1.2 Consistent style.** Menus throughout an application shall conform to a single style of interface, for example, OSF/Motif<sup>™</sup>, Open Look<sup>™</sup>, Microsoft Windows<sup>™</sup>, or Macintosh<sup>™</sup> (same as paragraph 8.4.1.1.1).
- **8.1.11.1.3 Consistent wording and ordering.** Menus and options that appear in different displays and contexts shall be consistent in wording and ordering (same as paragraph 8.4.1.1.2).
- **8.1.11.1.4 Consistent with command language.** If menu selection is used in conjunction with command language interaction, the wording of menu options shall be consistent with the command language.

**Definition.** A **command language** is a limited programming language used strictly for executing a series of commands.

- **8.1.11.1.5 Response time and display rate vs. menu length.** The design of menus should take into account the response time and display rate of the system. If the computer response time to a user action is long, menus should have relatively more options; if display rate is slow (that is, if it takes a long time to complete the drawing of a display), menus should have relatively fewer items.

**Discussion.** If the computer's response time is long, then menus should be broad and shallow and if the display rate is slow, menus should be narrow and deep.

- **8.1.11.1.6 Number of options.** The number of options in a menu should not be more than ten or less than three (same as paragraph 8.3.7.3.6).
- **8.1.11.1.7 Display of all options.** A menu shall display explicitly and completely all options available to a user at the current step in a transaction sequence.
- **8.1.11.1.8 Distinguishing unavailable options.** If a menu contains options that are temporarily unavailable, the unavailable options shall be displayed but clearly distinguishable from available options. For example, unavailable options might be displayed at reduced intensity ("grayed out") (same as paragraphs 8.1.11.2.7, 8.4.1.1.6, and 8.3.7.3.7).
- **8.1.11.1.9 Distinguishing types of options.** If a menu contains options of different types, for example, options that lead to other menus and options that are values that can be entered in fields, the types shall be distinguishable. For example, options that lead

to other menus might be followed by a triangle that points to where the subsequent menu will appear (▷ or ▽). A menu option that requires additional information from the user might be followed by an ellipsis (...) (same as 8.4.1.1.5).

- **8.1.11.1.10 Instructions.** Instructions pertaining to menus shall appear in a help window and in a consistent location on the display (same as paragraph 8.4.1.1.7).
- **8.1.11.1.11 Shortcuts for experienced users.** Experienced users should have a way to bypass the menu structure for frequently accessed options (see also paragraph 8.1.11.3.13).
- **8.1.11.1.12 Stacking menu selections.** If the selection of options from menus is accomplished by entering codes, and if a series of selections can be anticipated before the menus themselves are displayed, users shall be able to combine those selections into a single, stacked entry that is equivalent to the series of selections, but without having the menus displayed.

**Definition.** **Stacking** is the stringing together of commands so that they can all be executed with a single command.

- **8.1.11.1.13 Menus distinct from other displayed information.** Menus that appear in displays that also contain other objects or information shall be distinct from the other objects or information on the screen (same as paragraph 8.4.1.1.8).

### 8.1.11.2 Menu formatting

- **8.1.11.2.1 Presentation of options.** With the exception of a menu bar, the options in a menu should be presented in a single vertical column, aligned and left-justified.
- **8.1.11.2.2 Consistent menus and options.** If the same menu or option appears in different displays within an application, it shall be consistent in wording and ordering (same as paragraph 8.4.1.5.2).
- **8.1.11.2.3 Logical grouping of menu options.** If applicable, the options in a menu shall be presented in logical groups (same as paragraph 8.4.1.5.3).
- **8.1.11.2.4 Ordering groups of options.** Groups of options in a menu shall be ordered logically. If there is no apparent logical ordering, the groups shall be ordered by their expected frequency of use (same as paragraph 8.4.1.5.4).
- **8.1.11.2.5 Ordering options within a menu or group.** If a group of options or a menu contains a small number of options, the options shall be ordered by importance, logical sequence, or frequency of use. If a group or menu contains a very large number of options, the options shall be ordered alphabetically (same as paragraph 8.4.1.5.5).



- **8.1.11.2.6 Numbering menu options.** If task order is important, menu options should be numbered.
- **8.1.11.2.7 Distinguishing unavailable options.** If a menu contains options that are temporarily unavailable, the unavailable options shall be displayed but clearly distinguishable from available options. For example, unavailable options might be displayed at reduced intensity ("grayed out") (same as paragraphs 8.1.11.1.8, 8.4.1.1.6, and 8.3.7.3.7).

### 8.1.11.3 Hierarchical menus

Large or complex menus can be presented as hierarchical menus.

**Definition.** A **hierarchical menu** is a large menu that is organized as a multi-level, branching structure of smaller menus in which an option in a higher level menu is the name of another menu at the next lower level. The options in the lowest level menus are such things as commands or values; they are not the names of other menus.

- **8.1.11.3.1 When to use.** Hierarchical menus should be used if there are many options (more than 10), and the options can be organized in a branching structure.
- **8.1.11.3.2 Organizing and labeling hierarchical menus.** Hierarchical menus should be organized and labeled to guide the user within the hierarchical structure.

**Example.** When a user selects an option from a menu, the menu and the selected option remain on display with the selected option highlighted, and the lower-level menu that results from the selection is displayed adjacent to the selected option.

- **8.1.11.3.3 Consistent design and use.** The design and use of hierarchical menus shall be consistent across tasks and transactions within an application.
- **8.1.11.3.4 Minimum number of levels.** A hierarchical menu structure should minimize the number of selections required to reach the desired option. This implies the use of broad, shallow structures as opposed to narrow, deep ones.
- **8.1.11.3.5 Easy selection of important options.** Hierarchical menus should permit immediate user access to critical or frequently selected options.
- **8.1.11.3.6 Indicating current position in menu structure.** An indication of the user's current position in a hierarchical menu structure shall be provided.
- **8.1.11.3.7 Hierarchical menus in graphical user interfaces.** Hierarchical menu design in a graphical user interface should be as simple as possible; complex graphical structures should be avoided.

- **8.1.11.3.8 Top level menu.** The top level menu in a hierarchical menu structure shall serve as a consistent starting point for control entries. A user shall be able to return easily to the top level at any time.
- **8.1.11.3.9 Organization of a system-level menu.** The options of a system-level menu shall be grouped, labeled, and ordered in terms of their logical function, frequency of use, and criticality.
- **8.1.11.3.10 Return to system-level menu.** A user shall be able to return to a system-level menu from anywhere in a hierarchical menu structure with one simple control action.
- **8.1.11.3.11 Return to next higher level.** A user shall be able to return to the next higher level menu from anywhere in a hierarchical menu structure with one simple control action.
- **8.1.11.3.12 Lower level menus.** The options contained in a menu below the top level should be logically related to each other.
- **8.1.11.3.13 Bypassing menu selections.** The system or application should allow a user to bypass a series of menu selections by making an equivalent command entry (see also paragraph 8.1.11.1.11).
- **8.1.11.3.14 Software navigation aids.** Software navigation aids should be provided to assist the user in quickly selecting the desired menu (for example, a tree diagram or organization chart). The aid should permit a user to select a menu directly, without going through intermediate steps.

#### 8.1.11.4 Menu bars

This section presents criteria and guidelines for menu bars.

**Definition.** A **menu bar** is a menu that is usually displayed horizontally across the top of a display screen. The options on a menu bar are usually the names of other menus.

- **8.1.11.4.1 When to use.** A menu bar should only be used if the display screen size and resolution permit fast and accurate movement of the cursor onto the options.
- **8.1.11.4.2 Visibility of menu bar options.** Menu bar options should remain visible at all times.

#### 8.1.11.5 Pull-down menus

This section presents criteria and guidelines for pull-down menus.

**Definition.** A **pull-down menu** is a menu that appears when a menu bar option is selected.

- **8.1.11.5.1 When to use.** Pull-down menus should be used rather than pop-up menus if the position of the cursor on the screen is not important for information or option retrieval (same as 8.4.1.3.1).

**Discussion.** The advantage of pull-down menus over pop-up menus is that pull-down menus always have a visual cue in the form of a menu bar.

- **8.1.11.5.2 Consistent location.** Pull-down menus shall always appear immediately below the option whose selection leads to their appearance (same as paragraph 8.4.1.3.2).

### 8.1.11.6 Pop-up menus

Pop-up menus can be very useful in data entry. They can present to a user the permissible entries for a field, thus (1) eliminating the need for the user to remember the entries, (2) preventing invalid entries, and (3) eliminating potential typing errors.

**Definition.** A **pop-up menu** is a menu that is associated with a particular object on a display, for example, a pop-up menu listing acceptable command options close to the immediate work area. This is particularly useful for large displays, where the work site may be relatively removed from the menu bar.

- **8.1.11.6.1 When to use.** Pop-up menus should be used only if it is critical to the application that users be able to access functions without moving the pointing device. They should not be the only method for accessing operations, since the operations are hidden from view, requiring users to remember where they are and how to access them (same as paragraph 8.4.1.4.1).
- **8.1.11.6.2 Pop-up menu location.** A pop-up menu shall appear in a location that is coordinated with the location of the pointer (same as paragraph 8.4.1.4.2).
- **8.1.11.6.3 Selecting an option using a pointing device.** A user shall be able to select an option on a pop-up menu by moving the pointer onto the desired option and clicking the appropriate button (same as paragraph 8.4.1.4.3).

**Explanation.** This method is preferred to holding the button down while moving the cursor and releasing it to make a selection. The deliberate click method is less prone to error.

### 8.1.11.7 Selecting options

- **8.1.11.7.1 Equivalence of input devices.** The system or application shall provide a user the ability to use any of the input devices available to select a menu option. For example, if a user has both a pointing device and a keyboard available, he or she shall be able to use either to select an option (same as paragraph 8.4.1.6.1).
- **8.1.11.7.2 Initial cursor position for pointing devices.** If a user must select among displayed options using a pointing device, the cursor shall be placed on the default option when the display appears (same as paragraphs 8.1.6.10 and 8.4.1.6.4).

- **8.1.11.7.3 Initial cursor position for keyboards.** If a user must select among displayed options using a keyboard, the cursor shall be placed on the default option in the control entry area (with that control entry area having implicit input focus) when the display appears (see "discussion" in paragraph 8.3.4.3.1) (same as paragraphs 8.1.6.11 and 8.4.1.6.5).
- **8.1.11.7.4 Feedback for menu selection.** If no computer response is immediately observable when a user selects an option, the software shall provide some other acknowledgment of the selection. For example, the software might display a watch, hourglass, or a message stating the delay remaining or the elapsed time (same as paragraph 8.4.1.6.6).
- **8.1.11.7.5 Abbreviated entries.** If menu selection is by code entry, the application should accept both the complete and minimum distinguishing abbreviated forms of the code. For example, an application might accept **Q**, **QU**, and **QUIT** as equivalent.
- **8.1.11.7.6 Menu selection by pointing.** If menu selection is the primary interactive method, and especially if selections are made from extensive lists of options, selection by pointing device should be provided (same as paragraph 8.4.1.6.2).
- **8.1.11.7.7 Size of selectable area.** The effective pointing area for menu options shall be as large as is consistently possible. The area shall be at least the displayed option label plus a half-character distance around that label.
- **8.1.11.7.8 Two-action activation.** If menu selection is accomplished with a pointing device, activation shall consist of two actions: (1) designation, in which a user positions the cursor on the desired option (with that option being highlighted when the pointer is on the menu option), and (2) activation, in which a user makes a separate, explicit control entry (clicking the appropriate mouse button) (see the "discussion" in paragraph 8.8.3.7.2).
- **8.1.11.7.9 Number of selections per menu.** A user should be allowed to select only one option from a menu. If the menu is divided into groups, a user should be able to select only one option from each group, although users may be able to select multiple files from a menu (same as paragraph 8.4.1.6.7).

### 8.1.11.8 Titles and wording of options

- **8.1.11.8.1 Wording of options.** The wording of options shall use familiar terminology (such as those used in industry), but shall distinguish each option from every other option in the menu.
- **8.1.11.8.2 Options as commands.** Options should be worded as commands to the computer, not questions to the user.

- **8.1.11.8.3 Titles for groups of options.** If the options in a menu are grouped and titled, the titles should be comprehensible and unique.
- **8.1.11.8.4 Appearance of group titles.** The titles of groups of options shall appear in a format that is clearly distinguishable from that of the options themselves.

### 8.1.11.9 Coding options

Mnemonic coding can be of help to users. Mnemonic letters are the easiest codes to remember; numbers are intermediate; and nonmnemonic letters are the most difficult. Letters as codes also have a numerical advantage over numbers (there are 26 letters as opposed to only 10 numerals). Numerals have the advantages of making sequencing clear, being easier to locate on a keyboard by nontypists, and allowing a user to know immediately how many options there are.

- **8.1.11.9.1 Conveyed meaning of coding.** To the extent possible, an option code should suggest the meaning of the option it represents. An example would be the use of the first letter or letters of each option as the code.
- **8.1.11.9.2 Consistent coding.** The coding of menu options shall be consistent throughout an application and related applications.
- **8.1.11.9.3 Letter vs. numeric codes.** Letter and numeric codes should not be used in the same menu.
- **8.1.11.9.4 Numeric coding.** If menu options are numbered, numbering shall start with 1, not with 0.
- **8.1.11.9.5 Displaying option codes.** If menu options are coded, the codes shall be displayed with their options in a consistent, distinctive manner.

**Examples.** If numeric coding is used, the numerals might appear immediately to the left of the options. If mnemonic coding is used, the mnemonic letter or letters might be emboldened (**Undo**) or underlined (Undo).

### 8.1.12 Function keys

This section contains criteria and guidelines for assigning functions to function keys and using them (see also section 8.8.2).

- **8.1.12.1 Single function.** If feasible, a function key should be assigned only one function.
- **8.1.12.2 Consistency within an application.** If an application includes different operational modes and function key assignments that vary from mode to mode, to the extent possible, equivalent or similar functions shall be assigned to the same function key for all modes.
- **8.1.12.3 Consistency across applications.** If the same function exists in related applications, it shall be assigned to the same key in all applications.

- **8.1.12.4 Feedback.** Feedback shall be provided for function key activation. If the activation does not result in an immediately observable response from the computer, the user shall be given some other form of acknowledgment or feedback. No system function shall be activated without an indication to the user. If system functioning results in a long delay, the user shall be given feedback periodically.
- **8.1.12.5 "Soft" function keys.** If "soft" function keys are used, representations of the function keys should be presented on the screen. These representations should have the same spatial configuration as the "hard" function keys, and they should be located as near as possible to the hard keys, probably at the bottom of the screen (assuming the keyboard is normally positioned directly below the screen).

**Definition.** A **soft key** is an area on the screen that represents a function key. If a function key is assigned more than one function in an application, an associated soft key can be labeled with the function that is currently assigned to the key.

- **8.1.12.6 "Soft" function key activation.** If a screen includes "soft" function keys, and if the application provides a pointing device, a user should be able to initiate a function both by pressing the corresponding "hard" function key and by selecting the soft key with the pointing device.
- **8.1.12.7 Disabling of unused function keys.** Function keys that are unassigned or that are assigned a function that is not applicable at the moment shall be "disabled" by the computer. When some function keys are active and some are not, the system shall indicate which are active.

**Discussion.** This might be done by displaying only the active keys as "soft" keys on the screen, or by displaying active "soft" keys differently from inactive ones.

- **8.1.12.8 Easy return to base-level functions.** If functions assigned to a set of keys change as a result of user selection, it shall be easy for the user to return them to the initial, base-level functions. One way this might be done is to include the equivalent of a "Main Menu" key in all sets other than the base set of function keys.
- **8.1.12.9 User-defined functions (macros).** If appropriate, users should be able to define their own functions and assign them to function keys, either temporarily or permanently. This capability should not be provided if macros defined by one user might be used inadvertently by another user.
- **8.1.12.10 Single key operation for continuously-available functions.** If a function is available continuously, it shall be initiated by simply pressing its assigned function key or selecting a corresponding "soft" key.

- **8.1.12.11 Frequently-used functions.** If a function will be used frequently, if its use is critical, or if its timely use is critical, it shall be initiated with a single key operation.
- **8.1.12.12 Single key press.** A function key shall perform its labeled function with a single press of the function key. Function keys shall not change function with repeated key presses without an indication of the new function or change in mode.
- **8.1.12.13 Relationship of functions assigned to the same key.** If two or more functions are assigned to the same function key and they are accessed by simultaneously pressing the function key and another key, such as **Shift**, **Ctrl**, or **Alt**, the functions should be logically related to each other.
- **8.1.12.14 Relationship of sets of functions.** If two or more sets of functions are assigned to function keys and they are accessed by simultaneously pressing a function key and another key, such as **Shift**, **Ctrl**, or **Alt**, the logical relation between the sets should be consistent from one key to another.

**Example.** In a text processing application, one set of functions might apply to lines, another to paragraphs, and another to pages.

- **8.1.12.15 Labeling single-function keys.** A function key assigned a single function shall have a label on the keycap that clearly identifies the function and clearly distinguishes that function from others.
- **8.1.12.16 Labeling multifunction keys.** If a key is used for more than one function, the user shall be informed which function is currently available. One way to accomplish this is to display a label on a "soft" key on an adjacent portion of the screen.
- **8.1.12.17 Indicating status.** If applicable, the active or inactive status of a function key shall be indicated. One way to accomplish this is to change the appearance of displayed labels on the screen, for example, dimming inactive keys or displaying one status in dark text on a light background and the reverse for the other state.
- **8.1.12.18 Labeling of menu items selectable with function keys.** If items from a menu are to be selected using function keys, the items should be labeled with function key numbers (that is, **F1**, **F2**, and so on) and if screen "real estate" is not at a premium, they should appear as "soft" key labels above the function keys.
- **8.1.12.19 Importance and frequency of use.** Functions shall be assigned to keys in accordance with their importance and frequency of use. For example, an emergency function might be given the most prominent position, or the most frequently used function might be given the most convenient location.

### 8.1.13 Command language design

- **8.1.12.20 Safeguarding.** Function keys that have potentially disruptive consequences shall be safeguarded. Safeguarding may take the form of physical protection, software disabling, interlocks, or multiple key combinations.

- **8.1.13.1 Functional command language.** A command language shall be designed so that users can enter commands in terms of functions desired, without concern for internal computer processing, storage, and retrieval mechanisms.

**Definition.** A **command language** is a limited programming language used strictly for executing a series of commands.

- **8.1.13.2 Consistent syntax.** Command language syntax shall be consistent within an application and across related applications.

**Definition.** The **syntax** of a command language is the set of rules governing the language, for example, rules about the order in which parts of a command occur, or rules about punctuation in commands.

- **8.1.13.3 Complexity of command language.** The complexity of a command language (its syntax) should be minimized, especially if there will be many untrained or infrequent users.
- **8.1.13.4 Layered command language.** The command language shall be designed so that its features (functions) are organized in groups for ease of learning and use.
- **8.1.13.5 Command stacking.** Users should be able to make control entries in accordance with task requirements, entering more than one command before entering an "execute" command, if that best meets the task requirements.
- **8.1.13.6 Command entry area.** Each display shall provide a command entry area that is located consistently from display to display, for example, at the bottom of the screen.
- **8.1.13.7 Distinctive wording of commands.** Words in a command language shall be distinctive from one another, emphasizing significant differences in function.
- **8.1.13.8 Consistent wording of commands.** All words and their abbreviations in the command language shall be consistent in meaning and spelling from one transaction to another and from one task to another.
- **8.1.13.9 Familiar wording.** Words for use in command language dialog shall be chosen to reflect the user's point of view and shall correspond to the user's operational language.



- **8.1.13.10 Abbreviation of commands.** If a command language is necessary for the system, and if the operators may be power users, then commands should also have abbreviated forms having five or less characters.
- **8.1.13.11 Selection of commands.** Commands should be designed to aid memory.
- **8.1.13.12 Alternate wording.** If a system will have many novice or infrequent users, it should recognize a variety of synonyms or alternative syntax for each word defined in the command language.
- **8.1.13.13 "Word" length.** The length of an individual input word, such as a command or a key word, should not exceed seven characters.
- **8.1.13.14 Characters.** Commands shall have at least one alphabetic or numeric character. Commands consisting of only nonalphanumeric characters (such as \$ or @) shall not be used.
- **8.1.13.15 Punctuation.** The use of punctuation in commands shall be minimized. If a delimiter is needed, one delimiter, such as the slash (/), shall be used throughout an application and related applications.
- **8.1.13.16 Blank spaces.** Blank spaces should not be required or interpreted by an application.
- **8.1.13.17 Spelling errors.** Commands shall be selected so that likely spelling errors do not result in valid commands (for example, using DEL for Delete and SEL for Select might result in this sort of error, since the D and S keys are adjacent on QWERTY keyboards).
- **8.1.13.18 Editing commands.** Users shall be able to edit textual commands after they are typed, but before they are executed, using standard editing techniques (see section 8.4.4.2).
- **8.1.13.19 Execution.** Once a textual command has been composed, an explicit enter or execute action by the user shall be required.
- **8.1.13.20 Confirmation of a command.** If the execution of a command might result in a delay, the deletion or modification of data, or other potentially adverse consequences, the system or application shall inform the user of the nature of the consequence and request that the user confirm the command unless an **UNDO** command is available.
- **8.1.13.21 Unrecognized commands.** If the system or application does not recognize a command a user has entered, the system or application shall inform the user and request the user to revise or replace the command.

### 8.1.14 Query and natural language

This section contains criteria and guidelines for database queries.

**Definitions.** A **data base** is a set of interrelated data stored in a computer. A **query** is the process of specifying, locating, and retrieving data matching specified characteristics from a data base.

#### 8.1.14.1 General

- **8.1.14.1.1 Ease of use.** A query language should be easy to learn and use.
- **8.1.14.1.2 Interactive.** A query language should permit on-line, interactive use as opposed to batch or off-line use.
- **8.1.14.1.3 Natural organization of data.** A query language shall be designed so that it considers the structure or organization of the data as perceived by the user group.
- **8.1.14.1.4 Task-oriented queries.** In composing a query, a user shall be able to simply specify which data are requested, without having to tell the system how to find the data.
- **8.1.14.1.5 User assistance.** A query language should assist users in the construction of complex queries and in narrowing down overly broad queries.
- **8.1.14.1.6 Large-scale retrieval confirmation.** If a query will result in a large or time-consuming data retrieval, the system or application shall notify the user of the amount of data or time and request that the user confirm the transaction or take further action to narrow the query before proceeding. The user shall be able to interrupt the retrieval process (see section 8.1.4).
- **8.1.14.1.7 Logical combination queries.** A query language should permit the use of logical combinations in the formation of a query. Combinations that might be permitted include "and," "or," and "not."
- **8.1.14.1.8 Subsequent queries.** A query language should permit the linking of sequential queries so that subsequent queries can be based on the results of prior queries. An example might be: "Of those records retrieved, how many...."
- **8.1.14.1.9 Flexible queries.** If natural language query is permitted, the system or application shall allow users to employ alternative forms when initiating queries.

**Example.** A system might accept all of the following as equivalent:

Update network display within three miles.  
Update network display in a three mile radius.  
Update network display out to three miles.

- **8.1.14.1.10 Error detection and correction.** A query language should detect and notify users of syntax errors in queries and assist them in correcting the errors.
- **8.1.14.1.11 Formats matched to user needs.** Query and display formats should be matched to the nature of the searches users will make. If appropriate, more than one format should be provided.
- **8.1.14.1.12 User preferences.** To the extent practicable, users should be able to choose the type of format (pictorial, verbal, or tabular) they prefer for queries and displays.

#### 8.1.14.2 Query screen design

- **8.1.14.2.1 Applicable criteria and guidelines.** Query screen design shall conform to the criteria and guidelines in sections 8.3, 8.4, and 8.5.
- **8.1.14.2.2 Relevant information only.** Query screens should include only information that is relevant to the task, that is, information necessary to perform actions, make decisions, or answer questions.
- **8.1.14.2.3 Frequently-used information.** The most frequently used information should be located in the upper left portion of a screen and, if multiple screens are involved, on the first screen or screens.

#### 8.1.14.3 User requirements

- **8.1.14.3.1 Importance of search terms.** A query language should permit users to rank order the search terms in importance and use this ranking in displaying the retrieved information.
- **8.1.14.3.2 Redisplay.** A query language should retain the results of the previous search so that they can be redisplayed without repeating the search.
- **8.1.14.3.3 Spelling and word variants.** A query language should recognize:
  - a. spelling variations, for example gray and grey,
  - b. acronyms,
  - c. inverted word order, for example, television monitor and monitor, television, and
  - d. truncations.
- **8.1.14.3.4 Punctuation.** A query language should automatically remove or ignore punctuation in search terms.

- **8.1.14.3.5 Word roots.** A query language should include a means for reducing words to their root forms, for example, by removing suffixes, and searching for the roots.
- **8.1.14.3.6 Exceptions.** A query language should provide for a list of exceptional words that are accepted literally, that is, that are not reduced to their roots.
- **8.1.14.3.7 Appearance of output.** The appearance, print format, and organization of the output should be natural and acceptable to the users. Users should be able to specify report formats.
- **8.1.14.3.8 Assisting the user.** A query language should assist users in formulating searches to ensure maximum usefulness of the search results.

#### 8.1.14.4 Usability

- **8.1.14.4.1 Commands.** If used, commands should be in an easy-to-learn, user-oriented system language. They should be clear, unambiguous, and distinctive.
- **8.1.14.4.2 Minimal user effort.** The number of keystrokes required of users should be minimized.
- **8.1.14.4.3 Messages.** Messages to the user shall conform to the criteria and guidelines in section 8.1.3.
- **8.1.14.4.4 Ease-of-use features.** A query language should provide the following features to make it easier to use:
  - a. reuse of frequent queries,
  - b. user definition of macros,
  - c. keyboard accelerators,
  - d. automatic periodic backup,
  - e. a **Restore** utility to recover backup data, and
  - f. a **Pause** and **Resume** capability that would allow a user to stop working with the query language and resume at a later time.

#### 8.1.14.5 Searching

- **8.1.14.5.1 Searching operations.** A query language should provide the following searching operations to users:
  - a. a **Select** operation that enables users to select the desired data base,
  - b. **Create** and **Erase** operations that enable users to create and erase data sets,

- c. a **Combine** operation that enables users to combine data sets,
  - d. a **Report** operation that enables users to format, name, specify, display, print, and save a query,
  - e. a **Restrict** operation that enables users to restrict the output of a retrieval set,
  - f. a **Save** operation that enables users to save the results of a search,
  - g. a **Search history** operation that enables users to view a list of previous search commands upon request.
- **8.1.14.5.2 Control operations.** A query language should provide users the following control operations:
    - a. a **Mark** operation that stores the current field value for future reference, for example, marking a field or record for deletion,
    - b. a **Describe** operation that enables users to receive a detailed explanation or description of the current field value,
    - c. a **Drop** operation that drops the current field from the structure, and
    - d. a **Status** operation that enables users to request status information.
  - **8.1.14.5.3 Query formulation operations.** A query language should provide the following query formulation operations:
    - a. a **Select** operation that identifies the fields from tables and functions that will appear in the query results,
    - b. a **Compile** operation that generates and validates an executable operation,
    - c. a **Run** or **Do query** operation that causes execution of the query,
    - d. a **Show** operation that allows various presentations of a tabular result and that could be used to present a preview of the results of a query or report,
    - e. a **Modify** operation that allows users to make changes in the definition of an existing query or report, and
    - f. a **Save** operation that allows storage and repeated use or modification of a query.
  - **8.1.14.5.4 Abbreviations.** If abbreviations are used, they should be significantly shorter than the unabbreviated terms. Truncation

is the preferred form of abbreviation. A query language should recognize both the abbreviated and the unabbreviated term.

- **8.1.14.5.5 Search time feedback.** A query language should inform users if a search will take more than a short time to complete or will overload the computer, and it should prompt the user to confirm, modify, or terminate the search.
- **8.1.14.5.6 Additional operations.** A query language should provide the following additional operations:
  - a. a **Browse** operation that enables users to navigate through a data base,
  - b. a **Report format** operation that enables users to format the results of queries as reports,
  - c. a **Search index** operation that enables users to view the list of words and phrases available for searching, including a link to a data base thesaurus to suggest additional search terms,
  - d. a **Proximity searching** operation that enables users to search for words or terms in a positional relationship with word index fields, for example, titles or abstracts,
  - e. a logical search operation using the logical operators and, or, and not,
  - f. an iterative operation that enables users to define a search, view the results, refine the search, view the results, and so on,
  - g. an operation to specify a range of values for searching,
  - h. an operation to specify fields for searching,
  - i. an operation to specify field values for searching,
  - j. an operation to order field values, for example, numerically or alphabetically, and
  - k. an operation to search across files that enables users to obtain the number of references including the search term in all potential data bases.

#### 8.1.14.6 Multiple levels

- **8.1.14.6.1 Accommodating users differing in experience.** A query language should accommodate users with different levels of experience.
- **8.1.14.6.2 Changing levels.** Users should be able to change the level at which they interact with the language at any time during a session.

- **8.1.14.6.3 Context-sensitive help.** Context-sensitive help should be available upon user request at all levels.
- **8.1.14.6.4 Novice level.** At the novice level, a query language should enable a user to begin work with little or no training.

**Discussion.** A novice interface may contain only a subset of the search capabilities and fewer searchable fields, with the result that it may not attain the same specificity or variety of search techniques.

- **8.1.14.6.5 Prompting novices.** At the novice level, a query language should prompt users to select options from lists and should provide explanations of the options.
- **8.1.14.6.6 Commands for novices.** The command set for novices should be fewer and simpler than the command set for experts.
- **8.1.14.6.7 Commands for experts.** A query language for experts should allow the expert users to enter more than one command at a time.

## 8.1.15 Graphical controls

Icons may be used to represent operations, processes, and data structures graphically, and they may be used as a means of exercising control over system functions, components, and data structures.

### 8.1.15.1 Icons

- **8.1.15.1.1 Resolution.** Iconic representation shall not be used if display resolution is low.
- **8.1.15.1.2 Description.** An icon shall consist of a graphic image and where space permits, an identifying label. To the extent possible, the image shall represent or suggest the application or document it represents.
- **8.1.15.1.3 Labels.** Labels shall be the same as the title of the window, if possible, and it shall appear below the image. If the title is too long to fit, it shall be truncated, but shall be displayed in full when the icon has input focus (see paragraph 8.3.4.3.1).

**Discussion.** If there are so many icons displayed that the labels become too small to read, users must be able to choose whether or not to display the labels.

- **8.1.15.1.4 Consistency.** Icons shall be consistent within an application and across related applications.
- **8.1.15.1.5 Uniqueness of icons.** Any window that can be iconized should have a unique icon that serves as a visual representation of the window.
- **8.1.15.1.6 Icon design.** To the extent possible, icons should be simple line drawings that suggest the object or operation they

represent. Icons should be based on physical objects where possible. Humorous representations should be avoided.

**Examples.** Icons may be designed to represent a process or operation literally (for example, a drawing of an aircraft), functionally (for example, a figure representing a network), or operationally (for example, a drawing of a pen in hand on paper).

- **8.1.15.1.7 Manipulation of icons.** If direct manipulation interaction is used, the system or application should use a pointing device as the primary means of manipulation, not a keyboard.
- **8.1.15.1.8 Icon menu.** An icon shall have an icon menu that contains the same options as its window's system menu with the exceptions of **Resize** and **Iconize**. If the window menu includes these options, they shall appear on the icon menu as unavailable. (Current versions of Apple Macintosh™ do not support icon menus.)
- **8.1.15.1.9 Using the icon menu.** A user shall be able to display an icon menu by moving the pointer onto the icon and clicking the appropriate button. A user shall select an icon menu item using standard option selection methods (see section 8.4.1.6). A user shall be able to remove an icon menu by moving the pointer off the menu and clicking the appropriate button. (Current versions of Apple Macintosh™ do not support icon menus.)
- **8.1.15.1.10 Restoring the window.** A user shall be able to restore a window and any secondary windows that were displayed when the window was iconized by: (1) moving the pointer onto the icon and double-clicking the appropriate button, or (2) displaying the icon menu and selecting **Restore**.
- **8.1.15.1.11 Location of icons.** Unless specified otherwise by the application, icons shall be placed in the lower left corner of the screen, and arrayed in the order in which they are created, in rows from left to right and from bottom to top.
- **8.1.15.1.12 User preferences.** Users should have the option of changing the default location of icons. User-selected locations for icons should be retained across sessions.
- **8.1.15.1.13 Moving icons.** Users should be able to move icons using similar methods available for moving windows (see paragraphs 8.3.5.3 and 8.3.5.4).

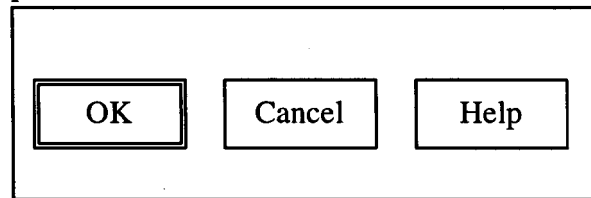
### 8.1.15.2 Push buttons

- **8.1.15.2.1 Consistent appearance.** All push buttons in a window should have the same size and shape. The size should accommodate the largest label.
- **8.1.15.2.2 Labels.** A push button shall have a label. The label may be either text or graphic.



- **8.1.15.2.3 Consistent labels.** Push button labels shall be consistent throughout an application and related applications.
- **8.1.15.2.4 Text labels.** Push button labels should be short and unambiguous. The label should describe the results of pressing the button and reflect the action that will be taken by the application rather than the user.
- **8.1.15.2.5 "Standard" actions.** To the extent possible, the labels of push buttons should be selected from the list of "standard" actions given in Appendix D.
- **8.1.15.2.6 Activating a push button.** A user shall be able to activate a push button by moving the pointer onto the button and pressing the appropriate pointer button. The push button shall be highlighted while the pointer button is depressed. The control shall be activated when the pointer button is released, and the push button shall revert to its normal appearance. A user shall also be able to activate a push button using the keyboard.
- **8.1.15.2.7 Default push buttons.** Default push buttons shall be clearly distinguishable from the other push buttons. For example, they may have an extra border, as illustrated in exhibit 8.1.15.2.7, by highlighting, or making them appear three-dimensional. A push button assigned an action that is potentially destructive shall not be designated as the default button.

**Exhibit 8.1.15.2.7** Example of a default push button



### 8.1.15.3 Radio buttons

Radio buttons (also known as exclusive buttons) are single, two-state choices, which are mutually exclusive from each other. For example, only one radio button can be "on" at a time. A radio button that is turned "on" will cause all of the other radio buttons to be turned "off."

- **8.1.15.3.1 When to use.** Radio buttons shall be used if it is required that one and only one of a set of mutually exclusive options be selected. Exhibit 8.1.15.3.1 illustrates two possible types of radio button sets.
- **8.1.15.3.2 Selecting an radio button.** A user shall be able to select a radio button using a pointing device by moving the pointer onto the radio button and clicking the appropriate device button. A user shall be able to select an radio button using the keyboard by moving a location cursor to the desired button (for example, using the arrow keys) and pressing the **Enter** key.
- **8.1.15.3.3 Selected button highlighted.** One and only one button in a set of radio buttons shall be highlighted. If a user selects an unhighlighted button, that button shall be highlighted, and the

previously highlighted button shall have highlighting removed. Selecting a button that is already highlighted shall not change its state.

#### 8.1.15.4 Check boxes

Check boxes (also known as nonexclusive buttons) are single, two-state choices. For example, a check box can be "on," (checked) or "off," not checked. A check box group is a collection of two-state choices, all of which apply to the same selected object. A check box that is turned "on" will not change the status of any other choice in the group.

- **8.1.15.4.1 When to use.**

Check boxes shall be provided if a user must be able to select any number, including none, of a set of options. For example, in specifying the appearance of text, a user might want to select both Bold and Italic.

- **8.1.15.4.2 Selecting check boxes.** Check boxes shall have two states, selected and unselected. Users shall be able to toggle the states using both a pointing device and the keyboard. The state of each option shall be indicated.

**Discussion.** One way the status might be indicated is by preceding each option with a "check box" that indicates whether or not the option is selected.

#### 8.1.15.5 Sliders (scales)

Sliders are appropriate when users must set a value within a fixed range but the precise value is less important than relative position, for example, setting the volume level of a tone signal. Sliders are also appropriate for continuous, rather than discrete, variables.

**Definition.** A **slider** is a control used to set a value and give a visual indication of the setting.

- **8.1.15.5.1 Components of a slider.** A slider shall have a movable marker that indicates the current setting and a line or rectangular area along which it moves.

**Discussion.** Tick marks and numeric values may be added to the line or rectangular area of the slider.

- **8.1.15.5.2 Readout.** If appropriate, the slider should provide a numerical readout of the current setting.

#### Exhibit 8.1.15.3.1 Two types of radio button sets

The exhibit shows two examples of radio button sets within rectangular frames. The first frame is titled "Radar Type" and contains three radio buttons: "ARSR" (unselected), "ASR" (unselected), and "ASDE" (selected, indicated by a filled circle). The second frame is titled "Select a Site" and contains four radio buttons: "BAL" (unselected), "DCA" (unselected), "ELM" (selected, indicated by a filled circle), and "PHL" (unselected).

- **8.1.15.5.3 Slider operation.** Users shall be able to change the setting of a slider by moving the pointer onto the marker and dragging it.
- **8.1.15.5.4 Labeling sliders.** A slider shall have a label or title that indicates the purpose of the slider, and, if appropriate, labels for the endpoints.

## 8.2 Basic screen design and operation

Screen design refers to the way information is arranged and presented on a display screen. Different systems and applications can perform a great variety of tasks. Some systems rely heavily on data bases and do not require immediate user response to information displayed on their screens. Other systems, such as control systems, require that the users make immediate decisions and issue commands based on information displayed to them. The designer needs to understand the primary function of the system being developed to provide an effective screen design.

### 8.2.1 Principles, features, and functions

#### 8.2.1.1 General principles

- **8.2.1.1.1 Simplicity.** Information should be presented simply and in a well-organized manner. Ways to achieve simplicity include the following:
  - a. The screen should appear to be orderly and clutter-free.
  - b. Information should be presented in consistent, predictable locations.
  - c. The language used should be plain and simple.
  - d. The means for moving around the screen and to related screens should be simple.
  - e. Interrelationships should be indicated clearly.
- **8.2.1.1.2 Logical grouping.** Data items on a screen should be grouped on the basis of some logical principle.
- **8.2.1.1.3 Minimal movement.** Screens should be designed to minimize both eye movement and pointer movement.
- **8.2.1.1.4 What information to display.** The information to be displayed should be prioritized so that the most important or critical information can be displayed all the time, and less important or critical information can be displayed upon a user's request.
- **8.2.1.1.5 Minimal information density.** The information density (the amount of information per unit area) of a screen should be

minimized by presenting only information that is essential to a user at any given time.

- **8.2.1.1.6 Screen density.** For text displays, screen density (the ratio of characters to blank spaces) should not exceed 60 percent; that is, not more than 60 percent of the available character spaces should be filled.
- **8.2.1.1.7 Integrated information.** If a user needs a variety of data to complete a task, those data should be provided in an integrated display, not partitioned in separate windows.
- **8.2.1.1.8 Directly usable form.** Information shall be presented to a user in directly usable form; a user shall not have to decode or interpret data.

### 8.2.1.2 Consistency

- **8.2.1.2.1 Consistent screen structure.** Screens throughout a system or application shall have a consistent structure that is evident to users.
- **8.2.1.2.2 Consistent screen elements.** Elements of screens such as headers, fields, and labels shall have the same appearance and relative location throughout a system or application.
- **8.2.1.2.3 Input prompts.** If applicable, an input prompt shall have a consistent location on all displays throughout a system or application.
- **8.2.1.2.4 Instructions and error messages.** Instructions and error messages shall appear in a consistent location on the screen (same as 8.1.5.2.12).

### 8.2.1.3 Context

- **8.2.1.3.1 Maintaining context.** An application should provide a means for ensuring that a user maintains an understanding of the context in which a task is being performed. For example, the application might display the results of those previous transactions that affect the current one, or it might display currently available options.
- **8.2.1.3.2 Highlighting.** When a user is performing an operation on a selected object in a display, that object shall be highlighted.

**Discussion.** In many applications, at least two different methods of "selection" highlighting can be provided. The first of these highlighting methods occurs when the pointer comes to rest for a predetermined time on a "selected" object. This is sometimes referred to as "dwell emphasis" and it tells the user which object the computer "perceives" the user is about to select. This highlighting is normally "dim" white. The second type of highlighting occurs when an actual selection has been made and is normally a "bright" white.

- **8.2.1.3.3 Display of context information.** Information intended to provide a context for the current user-computer interaction shall be distinctive in location and format, and shall be displayed consistently for all transactions within an application and among related applications.
- **8.2.1.3.4 Distinctive position and format.** Displayed options, command entry areas, prompts, advisory messages, and other displayed items (such as titles and time signals) relevant to transaction control shall be distinctive in location and format.
- **8.2.1.3.5 Operational mode.** If an application provides different operational modes, the current mode shall be continuously indicated to a user.
- **8.2.1.3.6 Current context indication.** If the consequences of a control entry will differ depending upon the context established by a prior action, a continuous indication of current context should be displayed.
- **8.2.1.3.7 Context-dependent actions.** The interpretation of a user action by the system shall be appropriate to the current context as determined by prior actions. A user shall not have to re-enter data he or she already entered in the current application session (see paragraph 8.1.1.8).
- **8.2.1.3.8 Action history.** If appropriate, an application shall maintain a summary of the transactions that produced the current context and display it at a user's request. If desirable, an application shall link an **UNDO** feature to each step in the action history.
- **8.2.1.3.9 Control parameters display.** A user shall be able to review all active control parameters upon request.

**Discussion.** Control parameters can include current and default settings, as well as settings applicable to a particular mode of operation. These parameters apply to the application software and to parameters of an external system being remotely monitored and controlled.

#### 8.2.1.4 Format

- **8.2.1.4.1 Title.** Every screen shall have a title or header at the top. The title or header shall describe briefly the contents or purpose of the screen. The title or header shall be separate and distinguishable from the body of the screen. (Current versions of Apple Macintosh<sup>TM</sup> do not offer titles on every screen.)
- **8.2.1.4.2 Other reserved areas.** Any interactive elements used in a screen, such as prompts, menu bars, command lines, and message areas, shall appear consistently in the same screen location throughout the system or application.

- **8.2.1.4.3 Layout of screen elements.** The layout of screen elements shall follow some organizing principle that users can recognize and apply.
- **8.2.1.4.4 Minimal visual competition.** Information on a display screen should be organized so that visual competition among distinct items of information is minimized. For example, underlining words interferes with reading.
- **8.2.1.4.5 Arrangement of screen elements.** Screens should be arranged so that there is a clear differentiation between instructions and data.
- **8.2.1.4.6 Location of displayed instructions.** If instructions to users are included in a display, instructions on how to do something on the screen should precede (be located above or to the left of) the relevant object; instructions about the disposition of the completed screen should be at the bottom of the screen.
- **8.2.1.4.7 Use of contrasting features.** Contrasting features such as inverse video or color should be used to call attention to critical screen components and urgent items.
- **8.2.1.4.8 Abbreviations.** The use of abbreviations shall be minimized. If they are used, they shall be used consistently, and a key or built-in reference table shall be provided. Abbreviations shall not be followed by periods.

### 8.2.1.5 Displaying text

Continuous text can be broken up by the use of blank lines or by using lines drawn between or around portions of text. The use of different intensity levels is another possibility, but may be undesirable, depending upon the levels available and the ambient lighting conditions. This section contains criteria and guidelines for displaying text; the display of data is covered in section 8.5.

- **8.2.1.5.1 Breaking up large blocks of text.** Large blocks of text should be broken into smaller, meaningful portions to minimize the amount of information requiring the user's attention at any given time.

**Discussion.** The readability of large amounts of text may be improved by presenting the text in two columns.

- **8.2.1.5.2 Lists.** A series or list of text elements should be presented vertically, not horizontally.
- **8.2.1.5.3 Order of information.** If displayed information is to be used in some spatial or temporal arrangement, its order in the screen shall preserve that arrangement. If ordering by sequence, function, frequency, or importance is not appropriate, some other method, such as alphabetical or chronological, shall be followed.
- **8.2.1.5.4 Primary viewing area.** Information that is particularly important or that requires immediate user response shall be displayed in the user's primary viewing area (see paragraph 7.2.1.6.8).

### 8.2.1.6 Scrolling and paging

- **8.2.1.6.1 Stationary text.** Text information shall be stationary on the screen; it shall not be scrolled continuously except with user action.
- **8.2.1.6.2 Paging.** If a screen contains too much data to display in a single frame, the data shall be partitioned into separately displayable pages.
- **8.2.1.6.3 Labeling pages.** In a multipage display, each page should be labeled with the number of the page and the total number of pages, for example, "Page 2 of 3."

### 8.2.1.7 Initial display

- **8.2.1.7.1 Initial display.** The initial display a user sees shall be a display that provides access to the highest level functions, resources, and applications available to the user. This includes access to the log on screen, user preference settings, utilities (such as a calculator, clock, and calendar), and system-level help.

**Exception.** If a system is dedicated to a single application, the initial display may be the initial display of the application.

- **8.2.1.7.2 Starting point.** In any display, it shall be obvious where the user is intended to "start." Ordinarily, this will be at the upper left part of the screen.

**Discussion.** This might be accomplished by placing the pointer, if there is one, at that point, or by highlighting the "first" part of the screen. Another alternative is to highlight the last active window or icon.

### 8.2.1.8 Matching controls to users

- **8.2.1.8.1 Minimizing the user's short-term memory load.** Windows should be designed to minimize the short-term memory load placed on a user as he or she performs the task called for by the window. A window should contain all relevant information and should allow a user to complete the task without having to refer to additional information.
- **8.2.1.8.2 Selecting a mutually exclusive option.** Exclusive button sets (radio buttons) should be used when users need to choose one option from a small number (up to six) of mutually exclusive options. A menu should be used for up to 10 options, and a scrolling menu should be used for more than 10 options.
- **8.2.1.8.3 Selecting nonmutually exclusive options.** If users need to select one or more of up to 10 nonmutually exclusive options, a nonexclusive button set (check boxes) should be used. For a larger set of options, a fixed or scrolling menu should be used.

- **8.2.1.8.4 Menus.** Menus should be used for selecting values and choosing from a set of related options.
- **8.2.1.8.5 Pop-up menus.** Pop-up menus should be used only if it is critical to the application that users be able to access functions without moving the pointing device. They should not be the only method for accessing operations, since the operations are hidden from view, requiring users to remember where they are and how to access them (same as paragraphs 8.1.11.6.1 and 8.4.1.4.1).

### 8.2.1.9 Arranging information to match user actions

- **8.2.1.9.1 Matching window layout to task.** Application designers should determine how users will activate the actions called for by a window and then design the window layout so that users can manipulate objects in ways that support task performance. For example, if an application generates information that will be presented a page at a time, the application should provide users with controls for performing paging operations. In addition, the objects in a window should be arranged so that users can move quickly and easily among them.
- **8.2.1.9.2 Matching window layout to users' "Natural" patterns.** Window layout should conform to users' natural scanning order and probable selection sequences. Usually, the order will be from left to right and top to bottom. For example, in button sets and menus, the most frequent choice should appear in the leftmost or top position.
- **8.2.1.9.3 Minimal user effort.** The amount of pointer movement and the number of keystrokes required to complete a task should be minimized.

### 8.2.1.10 Arranging information by importance

- **8.2.1.10.1 Location by importance.** The most important information and controls associated with a task should be located in the upper left part of its window and the least important at the bottom.
- **8.2.1.10.2 Task-critical information.** If a window contains task-critical information, that information should be displayed in a way that users can identify easily, for example, separating it from other information by blank space.

### 8.2.1.11 Visual and audible coding

- **8.2.1.11.1 Visual coding of critical information.** A user's attention should be drawn to critical information by highlighting,



color coding, or other means. Neither color coding nor uppercase letters should be used as the sole cue.

- **8.2.1.11.2 Flash coding.** If flash coding is used, it shall conform to the criteria and guidelines in section 8.5.4.6.
- **8.2.1.11.3 Audible coding of critical information.** If audible coding is used, it shall conform to the criteria and guidelines in section 8.5.4.3.

### 8.2.1.12 Dynamic information in windows

- **8.2.1.12.1 User control.** If a window contains automatically changing information, the application should provide users the ability to: (1) control the rate of update, (2) freeze the display of information, (3) resume updating from the time of freezing, and (4) resume updating from the current time.
- **8.2.1.12.2 Rate of updating.** If automatically changing information must be read reliably and accurately, the rate of update should not be more than once a second. If users must identify the rate of change or read only gross values, the rate of update should be from two to five times a second (see paragraphs 8.5.7.1.2 and 8.5.7.1.3).
- **8.2.1.12.3 Dynamic information in frozen, inactive, and iconized windows.** Applications should notify users of critical information that becomes available in frozen, inactive, and iconized windows. If a dynamic window is frozen temporarily, for example, while executing a print command, the application should notify the user immediately of any critical changes and prompt the user to return to automatic updating.

## 8.2.2 Operations

### 8.2.2.1 General

- **8.2.2.1.1 Screen saver.** Systems should provide a screen saver that blanks VDT screens or displays a message or graphic display that changes periodically. Screen savers should be activated when a screen has been idle for three minutes and deactivated when any new activity is detected. The time activation of the screen saver should be user selectable. A new activity includes pressing any key on the keyboard or moving a pointing device.

**Exception.** Displays containing screens such as a constant monitor screen or one in which users must track an activity over a period of time should not be equipped with a screen saver mode.

### 8.2.2.2 System log on and log off

- **8.2.2.2.1 Log on screen.** If a system uses a log on procedure, a log on screen should be displayed automatically as soon as a user completes any required start-up or power-up procedures (same as paragraph 8.3.9.1.2).
- **8.2.2.2.2 Log on prompts.** If a system log on procedure includes both an identification component (such as a user's name) and an authentication component (such as a user's password), the system shall provide a self-explanatory prompt for each component, with each prompt on a separate line.
- **8.2.2.2.3 Echoing of user's name, non-echoing of password.** If a log on procedure includes the entry of a user's name and a password, the system shall echo the user's name, but shall not echo the password on the screen.
- **8.2.2.2.4 Error messages.** If a user makes an error during the log on procedure, the system shall display an error message in the system message area or in a standard pop-up error window. The message shall provide guidance on how to correct the error, but shall not provide information that could assist someone trying to break into the system.
- **8.2.2.2.5 Completion of log on.** If applicable, upon completion of a log on, the system shall display a main menu or an application window.
- **8.2.2.2.6 System log off.** A user shall be able to log off a system by selecting the "log off" option from a system-level menu. This menu shall be available at all times the user is logged on.
- **8.2.2.2.7 Prompting to exit an application or save entries.** If an application is running, and the user initiates a system log off, the system shall prompt the user to save any unsaved entries and exit the application.
- **8.2.2.2.8 Confirming a log off.** The system shall prompt the user to confirm a log off request.
- **8.2.2.2.9 Completion of log off.** After completing a system log off, the system shall display the initial system log on screen.

### 8.2.2.3 Application log on and log off

An application available in a system may require its own log on and log off procedures.

- **8.2.2.3.1 Log on.** If an application log on is required in addition to the system log on, it shall conform to the same rules as system log on (see section 8.2.2.2).
- **8.2.2.3.2 Log off.** Logging off an application shall be accomplished with an "exit" function. This function shall be available to users at all times they are logged on to the application.

- **8.2.2.3.3 Confirming an exit.** The system shall prompt the user to confirm an application exit request.
- **8.2.2.3.4 Preserving unfinished work.** If the application contains unsaved inputs when the log off request is made, the application shall prompt the user to (1) save the work, (2) confirm the log off, or (3) cancel the request.
- **8.2.2.3.5 Completion of log off.** Logging off an application shall result in the removal of all screens associated with that application. If one or more other applications are running, the next most current application shall be displayed. Otherwise, the system main menu shall be displayed.

### 8.2.3 Characters and line length

- **8.2.3.1 Capitalization.** The United States Government Printing Office *Style Manual* shall be used as a guide for capitalization. If the *Style Manual* does not provide the guidance needed, Merriam Webster's *New International Dictionary* shall be used (same as paragraph 10.2.3.10.1).
- **8.2.3.2 Capitalization of phrases for emphasis.** In general, capitalization shall not be used to emphasize phrases or sentences (see section 10.3.3.7 for the recommended ways to emphasize text) (same as paragraph 10.2.3.10.2).

**Discussion.** Continuous text is easiest to read and comprehend when it is presented in mixed case letters. Single words are recognized better when printed in all upper case letters. Thus, if used sparingly and wisely, capitalization can be used to indicate to readers that a word has special significance.

- **8.2.3.3 Spacing between characters.** Spacing between characters should be at least 10 percent of character height (same as paragraph 7.2.4.7.7).
- **8.2.3.4 Spacing between words.** Spacing between words shall be at least one character width for equally-spaced characters or the width of capital N for proportionally-spaced characters (same as paragraph 7.2.4.7.8).
- **8.2.3.5 Spacing between lines.** Spacing between lines shall be at least two stroke widths or 15 percent of character height, whichever is greater. This space is in addition to any space required for accent marks on upper case characters and descenders on lower case letters (same as paragraph 7.2.4.7.9).

**Note.** The interline spacing recommended for text displayed on terminals is greater than that recommended for printed material (see paragraph 10.3.3.3.1).

- **8.2.3.6 Spacing between paragraphs.** Paragraphs shall be separated by a blank line.
- **8.2.3.7 Minimum character height.** The minimum height of displayed characters should be 1/200 of the viewing distance. For example, for a viewing distance of 800 mm (31.5 in), characters should be at least 4 mm (0.16 in) high (same as paragraph 8.3.10.4.3).

**Discussion.** In some cases, a screen will be read by a person standing behind a seated user. The character height would be based on the maximum viewing distance, not the "normal" or "typical" distance.
- **8.2.3.8 Character width.** The ratio of character height to width shall be:
  - a. 1:0.7 to 1:0.9 for equally-spaced characters and lines of 80 or fewer characters,
  - b. at least 1:0.5 if it is necessary to have more than 80 characters per line, or
  - c. as much as 1:1 for characters such as M and W for proportionally-spaced characters (same as paragraph 7.2.4.2.5).
- **8.2.3.9 Stroke width.** Stroke width should be 10 to 12.5 percent of character height.
- **8.2.3.10 Minimum dot matrix.** If characters are formed using a dot matrix, the matrix should be at least 7 dots wide and 9 dots high.

## 8.2.4 Color

As emerging information management and control systems implement graphical user interfaces and high resolution color graphics displays, color has become a prominent coding method. Color can reduce clutter in screens and can improve a user's performance. But, if used inappropriately, color can also induce the very clutter and performance degradation it attempts to reduce. For these reasons, color in a display must be used very carefully. Designers need to keep in mind that:

- a. Both brightness and type of lighting can affect the way colors are perceived. For example, bright ambient light desaturates display colors, leading to degraded color identification and discrimination. In effect, similarly colored objects can appear different under different lighting conditions. And conversely, dissimilar colors can appear similar under different lighting conditions.
- b. The color of a foreground object is affected by the color of the background.
- c. Visibility and readability are affected by the contrast between the foreground and the background.

### 8.2.4.1 Color selection

- **8.2.4.1.1 General principles.** The following general principles shall be applied to the use of color in screens especially when the color deficiency in the user population is unknown.
  - a. Color shall be used sparingly as an information discriminator.
  - b. Colors shall be used consistently within a screen and across a set of screens within an application.
  - c. The meanings of colors used shall be consistent with user expectations.
  - d. Color shall be redundant to another form of coding, such as shape.
  - e. To the extent possible, color coding shall be standardized across applications.
- **8.2.4.1.2 When to use color.** Color should be used to:
  - a. augment a user's understanding of the information being presented,
  - b. attach specific meaning to a portion of text or a symbol,
  - c. direct a user's attention to something,
  - d. help a user differentiate rapidly among several types of information,
  - e. increase the amount of information conveyed, and
  - f. indicate changes in status.
- **8.2.4.1.3 Constraints on the use of color.** The use of color should avoid or minimize difficulties for users having impaired color vision. Some ways to minimize such difficulty are listed here.
  - a. Color should only be added after the effectiveness of a screen has been maximized in an achromatic format.
  - b. If similar hues are used, they should be used only with logically related information.
  - c. If color is used to emphasize information, the brightest color should be used for the most important information.
  - d. The use of color should not reduce screen readability.

- **8.2.4.1.4 Discrimination of colors.** The colors selected for coding on a screen shall be easily discriminated in all expected operating conditions.

**Discussion.**

Exhibit 8.2.4.1.4 lists some colors (and their wavelengths) that differ enough to permit easy discrimination.

**Exhibit 8.2.4.1.4** Discriminable colors and their wavelengths

<u>Color</u>	<u>Wavelength (millimicrons)</u>
Red	700
Orange	600
Yellow	570
Yellow-green	535
Green	500
Blue-green	493
Blue	470

- **8.2.4.1.5 Colors for infrequently used information.** Shorter wavelength colors (such as blue and green) should be used to display information that is used infrequently.
- **8.2.4.1.6 Colors for action and status.** Longer wavelength colors (such as red and orange) should be used to suggest action or a demand for a response. Shorter wavelength colors (such as green and blue) should be used to display status or background information.
- **8.2.4.1.7 Consistent use.** Color shall be used consistently from screen to screen and from application to application.
- **8.2.4.1.8 One meaning per color.** Each color should represent only one category of displayed data.
- **8.2.4.1.9 Consistent with conventions.** Color coding shall be consistent with conventional associations with particular colors. For example, red is conventionally associated with danger and power on, and yellow is conventionally associated with caution.
- **8.2.4.1.10 Number of colors to use.** Color should be introduced into screens conservatively, using relatively few colors to designate critical categories of displayed data, and only if it will facilitate user understanding or performance.
- **8.2.4.1.11 Maximum number of colors.** The total number of colors used should not exceed four for a single alphanumeric screen and seven for a set of related screens.
- **8.2.4.1.12 Additional colors.** Additional colors (more than four) should be reserved for special use (for example, in map displays).

**Discussion.** Only eight or nine highly saturated colors can be easily discriminated.

- **8.2.4.1.13 Adjacent colors.** Colors displayed next to each other should conform to the following rules:

- a. Highly saturated colors with significantly different wavelengths (such as those toward opposite ends of the spectrum) should not be used next to each other; examples are red and blue, yellow and purple, and magenta and green.

**Definition. Saturation** is the relative amount of whiteness in a chromatic color.

- b. To convey similarity, similar colors should be used; examples are orange and yellow, and blue and violet.
- c. The foreground color should contrast highly with the background color.

**Definition. Contrast** is the perception of the difference in the intensity of two areas.

- **8.2.4.1.14 Color and ambient illumination.** Red should be used only if high ambient illumination is expected. Green and yellow should be used if a broad range of illumination is expected.
- **8.2.4.1.15 Color key.** If the use of color is extensive or unusual, or if a display may be used infrequently, the display should include a color key that explains the meanings of the colors. If used, a color key should be readily accessible, that is visible without the user having to scroll or expand the display. A color key should include the actual colors being defined.
- **8.2.4.1.16 Colors at the periphery of large screen displays.** Red and green should not be used at the periphery of large screen displays. Yellow and blue are good colors for use in this area.
- **8.2.4.1.17 Limiting user color settings.** If a VDT will be shared by different users, individual users shall not be allowed to change those colors in an application that involves color coding or status.
- **8.2.4.1.18 Easy return to default color scheme.** If users are allowed to change color settings of aspects of an application that do not involve coding, the application shall provide an easy way to restore the default color scheme.
- **8.2.4.1.19 Portable applications.** If an application is likely to be used on different hardware configurations, it shall be able to accommodate the possible differences in color representations in the different configurations. Status colors shall be assigned during installation, and users shall not be allowed to change them.
- **8.2.4.1.20 Text-background contrast.** The contrast between text and its background shall be sufficiently high to ensure readability of the text. In general, the color foreground shall differ from its background by a minimum of 100  $\Delta E$  (CIE  $Y_u' v'$ ) distances. Luminance contrast ratios for a variety of tasks and conditions shall not be less than those given in exhibit 8.2.4.1.20.

**Exhibit 8.2.4.1.20** Luminance contrast ratios for various conditions

Condition	Ratio of foreground to background
Bright ambient illumination	> 7:1
Dark ambient illumination	3:1 to 5:1
To attract attention	> 7:1
To sharpen edges	> 7:1
Continuous reading	3:1 to 5:1
Camouflage images or smooth edges	< 3:1

- **8.2.4.1.21 Green, yellow, and red.** If green, yellow, and red are used, they shall be used in combination with other cues, such as brightness and saturation, to enhance their discriminability.
- **8.2.4.1.22 Blue.** Blue should not be used as the foreground color if resolution of fine details is required. Blue is acceptable as a background color.
- **8.2.4.1.23 Colors for comparison.** If a user must compare data (such as those contained in graphs) based on color, green, yellow, and red should be avoided as comparison colors for application information requiring important or frequent discriminations. If possible, the combinations yellow and blue or red and cyan should be used.
- **8.2.4.1.24 Small areas.** Users shall not have to discriminate among colors in small areas of the display. If small areas must be coded, they shall be coded achromatically.
- **8.2.4.1.25 Highlighting.** Highlighting to draw attention to portions of a screen shall be as follows:
  - a. White highlighting shall be used to draw attention to particular data. When the background is dark, white highlighting shall be used with dark letters. When the background is light, dark highlighting shall be used with white letters.
  - b. The size and number of areas highlighted shall be minimized.

**8.2.4.2 Tonal color coding**

This section contains criteria and guidelines about the use of tonal color and shading.

**Definition. Tonal coding** is coding based on different shades of the same hue or different patterns or textures.

- **8.2.4.2.1 When to use.** Tonal coding should be used to show relative values of a single variable.



- **8.2.4.2.2 Ordered coding.** If tonal coding is used to display relative values of a variable, the lightest shade should correspond to the smallest value, and the darkest shade should correspond to the highest value.

### 8.2.4.3 Color-coded symbols

- **8.2.4.3.1 Code symbol, not text.** If color is used to indicate status changes, the text itself shall not change color, rather, a box or other shape adjacent to the text shall change color.
- **8.2.4.3.2 Symbol size.** A symbol that is color coded shall subtend a visual angle of at least 20 min. For example, at a viewing distance of 800 mm (31.5 in), a symbol would be at least 5 mm (0.2 in) high.
- **8.2.4.3.3 Symbol brightness.** Color-coded symbols shall have a minimum brightness of 3.43 cd/m<sup>2</sup> (1 fL).
- **8.2.4.3.4 Refresh rate.** Color-coded symbols shall have a refresh rate that provides no perceptible flicker.

## 8.3 Windowing

Windows provide a convenient and easy to use means of organizing many of the interactive aspects of a system or application and presenting them to a user.

**Definition.** A **window** is a rectangular area on the screen that provides a visual means for interaction with an application. Applications also use windows to provide information to the user.

This section contains criteria and guidelines for window components, appearance, and states, for window controls and operations, for menus and text in windows, and for a variety of special purpose windows.

**Caveat.** Much of the material contained in section 8.6 may be very closely tied to a particular scheme or model for implementing windows and handling window management operations. The scheme being alluded to in any one rule may not be the only way of handling windows, nor is it the only recommended, approved, or acceptable way of doing so. To imply otherwise might violate the intent (if not the letter) of paragraph 4.1.10 of this standard. The authors of this guideline have, to the extent possible, removed guidelines that would have eliminated or restricted a particular window management system.

For example, the OSF/Motif™, Open Look™, Apple Macintosh™, and Microsoft Windows™ window management systems all offer similar, but slightly differing models for accomplishing many of the same windowing functions. To prematurely focus upon and exclusively adopt any single one of these management

systems would do a disservice to the users of this proposed guideline.

However, to simply strike out all such implementation-specific referential paragraphs within this section would result in removing a great deal of potentially helpful or useful design guidance information. The editors of these guidelines have chosen to retain these paragraphs for the potential value they might offer as examples of at least one acceptable method of implementing a windows operating environment.

### 8.3.1 General

- **8.3.1.1 Hardware limitations on the use of windowing.** Windowing shall be avoided when the hardware has the following limitations:
  - a. small screen size, resulting in frequent manipulation of the screen by the user,
  - b. slow processing speed, resulting in slow operation by the computer, or
  - c. low screen resolution, resulting in less effective visual coding, especially for map graphics, symbols, and icons.
- **8.3.1.2 User-specified windows.** When the need to view several different types of data simultaneously, the user shall be able to display and select separate windows on a single CRT screen.
- **8.3.1.3 Number of allowable open windows.** The number of allowable open windows shall not compromise system response time.

**Discussion.** Each open window requires system resources in terms of memory and processing speed. A limit on the maximum number of windows that can be effectively opened for each system needs to be predetermined.

### 8.3.2 Window components and appearance

#### 8.3.2.1 General

This section applies to window management systems that have the capability to display primary and secondary windows.

**Definitions.** A **primary window** is a top or high level window in an application. A **secondary window** is a window that is displayed from within a primary window or another secondary window. Secondary windows are also called "child" windows.

- **8.3.2.1.1 "Primary" windows.** A "primary" window shall contain: (1) a title bar, (2) a border, and (3) a window menu

control, and (4) a working area. It may also contain a menu bar, controls, objects, and icons.

- **8.3.2.1.2 "Secondary" windows.** A "secondary" window shall contain: (1) a title bar, and (2) a working area. Secondary windows may contain any of the other window components appropriate to the application.
- **8.3.2.1.3 Secondary window constraints.** Secondary windows should be subject to the following constraints:
  - a. A secondary window should be associated with a particular primary or secondary window.
  - b. When present, a secondary window should appear within the borders of and on top of (superimposed on) its "parent" window.
  - c. Closing a secondary window should not affect the parent window.
  - d. A secondary window should be removed when its parent window is removed.
- **8.3.2.1.4 Window placement.** Each primary and secondary window shall have a default location defined by the application, at which the window appears when it is first opened. If a window has been moved or resized or both, and is then closed and reopened during an application session, it shall reappear in the size and location it had when it was closed. At the next application, it shall appear in its default location.

### 8.3.2.2 Title bar

- **8.3.2.2.1 Description.** A title bar shall appear as a rectangular area at the top of a window, inside the window border with the title of the window in the center; it may contain: (1) a control at the left end that when activated produces a menu of window management options and (2) **Iconize** and **Maximize** controls at the right end.

### 8.3.2.3 Border

- **8.3.2.3.1 Description.** Primary and secondary windows shall have a border that encloses all of the window components.

### 8.3.2.4 Menu bar

(Current versions of Apple Macintosh<sup>TM</sup> and Open Look<sup>TM</sup> do not support complete interchangeability between a pointing device and the keyboard for navigation to or within a menu bar.)

- **8.3.2.4.1 Navigating to the menu bar.** Users shall be able to access the menu bar using both the pointing device and the keyboard. If this is done with the pointing device, the option nearest the pointer when the device button is clicked shall be highlighted. If it is done with the keyboard, the first (leftmost option) shall be highlighted.

**Definition.** A **location cursor** is an indication of the object in a window that has input focus (see paragraph 8.3.4.3.1). Its shape depends on the type of object; often it is a rectangle that outlines or highlights the object.

- **8.3.2.4.2 Navigating within a menu bar.** Users shall be able to move the location cursor within a menu bar using both the pointing device and the keyboard. Using the keyboard, users shall be able to move the cursor by pressing the left and right arrow keys, with movement wrapping from the first and last options and may include the system menu of the primary and secondary windows.
- **8.3.2.4.3 Selecting an option in a menu bar using its mnemonic.** Users shall be able to select an option in the menu bar of a window that has input focus (see paragraph 8.3.4.3.1) by typing the mnemonic (same as paragraph 8.3.7.2.4).
- **8.3.2.4.4 Leaving the menu bar.** Users shall be able to move the location cursor from the menu bar using both the pointing device or the keyboard. If this is done with the pointing device, the location cursor shall move to the object nearest the pointer when the device button is clicked. If it is done with the keyboard, the location cursor shall return to the object that had input focus before the cursor was moved to the menu bar.
- **8.3.2.4.5 Displaying a pull-down menu.** Users shall be able to display the pull-down menu for a menu bar option using either the pointing device or the keyboard. When the pull-down menu appears, the location cursor shall be placed on the first option.
- **8.3.2.4.6 Selecting the default option on a pull-down menu.** Users should be able to select the default option on a pull-down menu by double-clicking on the menu bar option. This should result in the selection of the default option on that menu without the display of the menu.

### 8.3.3 Window controls

This section contains criteria and guidelines for window controls.

**Definitions.** A control is any object that allows a user to perform an action. Controls include buttons, menu options, settings, sliders, text fields, and check boxes. A **push button** is a control that appears as a bounded area (for example, a rectangle or oval) on a window. Examples of common push buttons are **OK**, **Cancel**, and **Help**. Examples of the actions push buttons perform are initiating a command, displaying a pop-up window, and displaying a menu.

#### 8.3.3.1 General

- **8.3.3.1.1 Consistent and distinctive.** Each type of control in an application window shall be consistent and visually distinct from other types of control. For example, push buttons shall be consistent and distinct from radio buttons (exclusive button sets).

- **8.3.3.1.2 Distinct from other objects.** Controls shall differ in appearance from other text and graphics in an application window.

### 8.3.3.2 Text fields

- **8.3.3.2.1 Applicable criteria and guidelines.** The fields in windows shall conform to the criteria and guidelines for fields in forms given in section 8.4.2.
- **8.3.3.2.2 When to use.** If a user must be able to type input from the keyboard, a text field shall be provided.
- **8.3.3.2.3 Scrolling fields.** If a text field will accept more text than can be displayed in the field, a scroll bar shall be provided to enable users to see the entire text. If the anticipated text is expected to exceed a single line, the text field shall be large enough to view multiple lines simultaneously.

### 8.3.3.3 Scroll bars

- **8.3.3.3.1 When to use.** If a textual or graphic entity exceeds the space available to display it, a mechanism such as a vertical scroll bar, a horizontal scroll bar, or both shall be provided to enable users to view the entire entity.
- **8.3.3.3.2 Scroll bar components.** A scroll bar shall contain:
  - a. a symbol, such as a box or rectangle, that represents the portion and location of the entity currently displayed,
  - b. a vertical or horizontal line or area along which the current display symbol can move, the length of which represents the entire entity, and
  - c. two symbols, one above and one below the current display symbol, that allow a user to step through the entity a unit at a time.
- **8.3.3.3.3 Current display symbol.** The ratio of the length of the current display symbol to the length of the line or area along which it moves should equal the ratio of the portion of the entity displayed to the entire entity.
- **8.3.3.3.4 Required scroll bar operations.** Users shall be able to operate the scroll bar in at least the following two ways:
  - a. Users shall be able to drag the current display symbol continuously along its line or area using a pointing device.
  - b. Users shall be able to step through the entire entity in appropriate units, for example, a screen at a time.
- **8.3.3.3.5 Recommended scroll bar operations.** Users should be able to move directly to a desired position in the window by moving the pointer to a location of the line or area along which

the current display symbol moves and clicking the appropriate device button.

### 8.3.4 Window states

#### 8.3.4.1 Open, closed, iconized

- **8.3.4.1.1 Open window.** An open window shall be capable of receiving input from the system. A window that is open and active (see paragraph 8.3.4.2.1) shall be capable of receiving input from a user. An open window shall be completely visible on the screen at the time it is opened and when it is active.

**Discussion.** More than one window can be open on a screen at the same time. An open window may be partially or totally obscured by another open window, that is, an open window may or may not be visible.

- **8.3.4.1.2 Closed window.** A closed window shall have no appearance on the screen, neither as a window nor as an icon.
- **8.3.4.1.3 Closing a primary window.** When a primary window is closed, it and any of its secondary windows shall be removed from the screen. If the window had input focus, the user shall explicitly select another window to have focus; the application shall not arbitrarily assign focus to another window on the screen unless emergency action is required.
- **8.3.4.1.4 Closing a secondary window.** When a secondary window is closed, it and any of its secondary windows should be removed from the screen. The parent window should not be affected except for the disappearance of the secondary window.
- **8.3.4.1.5 Iconized windows.** If a user iconizes an open window, the window and any open secondary windows shall be replaced by the window's icon. Any processing occurring in the window may continue.

**Definition.** To iconize a window is to convert it from a window to an icon (see paragraphs 8.3.5.9 and 8.3.5.10).

- **8.3.4.1.6 Restoring an iconized window.** It shall be possible to restore an iconized window by using the pointing device, if available (see paragraph 8.3.5.11), and by using the keyboard (see paragraph 8.3.5.12). When the primary window appears, it and all secondary windows associated with it that were open when it was iconized shall be displayed.

#### 8.3.4.2 Active, inactive

- **8.3.4.2.1 Active windows.** Only one window at a time shall be "active." That window shall have input focus (see paragraph 8.3.4.3.1), and it shall be completely visible, that is, it shall not

be obscured by any other window or icon. An active window shall be distinguishable from inactive windows.

**Exception.** Complex situations may occur where one window has input focus for keyboard and mouse inputs and another window has input for voice entries.

- **8.3.4.2.2 Making a window active.** Users shall be able to make any open window active using the **Previous window** operations.
- **8.3.4.2.3 Making a window inactive.** A window shall become inactive when the user makes any other window active.

**Discussion.** An inactive window continues to be displayed on the screen, but may be obscured by other windows.

### 8.3.4.3 Input focus

(Current versions of Apple Macintosh™ do not support the ability to assign input focus with the keyboard.)

- **8.3.4.3.1 One input focus.** Regardless of the number of windows open in an application, only one window at a time shall be able to receive input from the keyboard.

**Definition. Input focus,** also called keyboard focus, is the notion that only one window, and usually only one object in a window, at a time is capable of accepting input from the keyboard. Input focus can be explicit (the user must move the pointer into the window and click the appropriate mouse button), or implicit (the user must only move the pointer into the window).

- **8.3.4.3.2 User assignable input focus.** Users shall be able to assign input focus to any open window of the current application, either with a pointing device or from the keyboard.
- **8.3.4.3.3 Assigning input focus with a pointing device.** Users shall be able to assign input focus to any window that is wholly or partially visible by moving the pointer onto any visible portion (and clicking the appropriate button, where explicit input focus is necessary). If any portion of the window was obscured by another window, the window with focus shall be made wholly visible.
- **8.3.4.3.4 Assigning input focus with the keyboard.** Users shall be able to assign input focus to any open window by moving "forward" or "backward" one window at a time through the open windows. For example, users shall be able to press a single key or specific key combinations to move the focus forward or backward one window. Open windows shall be accessible in this way in the order in which they were opened.
- **8.3.4.3.5 Single object focus.** Only one object in the window having input focus shall be able to receive input from the keyboard. The location cursor or highlighting shall indicate the object having focus. When a window receives input focus, the

location cursor or highlighting shall be placed on either (1) the object that last had focus or, if applicable, (2) the object the pointer was on when focus was achieved.

- **8.3.4.3.6 Location cursor.** If an object has input focus, that object shall be indicated with a location cursor or highlighting. When a window first appears, the location cursor or highlighting shall be placed on the object users are most likely to select, for example, a text field or a default push button. If a window has lost and then regained input focus, the location cursor or highlighting shall be placed on the object that last had input focus in the window. A user shall be able to move the location cursor or highlighting among objects in the window using either the pointing device or the keyboard.

**Discussion.** The shape of the location cursor depends upon the nature of the object; sometimes, it is a rectangular box that surrounds the object.

- **8.3.4.3.7 Assigning input focus to an object** Users shall be able to assign input focus (the location cursor) to an object within a window using either the pointing device or the keyboard.
- **8.3.4.3.8 Moving input focus to an object with a pointing device.** Users shall be able to move input focus (the location cursor) among objects within a window by moving the pointer onto an object (and clicking the appropriate button, where explicit input focus is necessary).

#### 8.3.4.4 Window mode

Windows may be either "modal" or "modeless."

**Definitions.** If a **modal** window is on display, a user must interact with that window before he or she can interact with other windows. If a window is **modeless**, a user can interact with other windows.

- **8.3.4.4.1 Primary window mode.** The primary application window shall be modeless, that is, users shall be able to interact with other windows.
- **8.3.4.4.2 Secondary window mode.** Secondary windows shall be either modal or modeless. If a window is modal, a user shall not be able to interact with other windows as long as it is displayed. That is, the user must interact with the modal window before being able to interact with any other. If it is modeless, a user shall be able to interact with other windows. The scope of the inability to interact with other windows while a modal window is displayed shall be determined by the application and may extend to: (1) the parent window, (2) all other windows in the application, or (3) all other windows on the screen.

#### 8.3.5 Window operations

For each system or application, the window operations that are performed needs to be identified and their manner of execution made consistent throughout the system. This means that a "standard" way to execute an operation must be available. It is not meant to prohibit developers from providing additional



approaches, for example, providing one method for novices and another for experts. (Current versions of Apple Macintosh™ do not support the ability to move, resize, or iconize windows using a keyboard.)

- **8.3.5.1 Restoring window to default size.** Where applicable, the application shall provide a **Restore** operation that enables a user to restore an iconized or maximized window to its default size. This option shall be unavailable when the window is its default size.

**Discussion.** Some icons may not have an associated window. For example, an icon that provides a DOS prompt will not have a window that can be restored.

- **8.3.5.2 Move.** Where applicable, the application shall provide a **Move** operation that enables a user to move a window on the screen.

**Discussion.** In some applications, users are not be able to move all windows. For example, some windows are only advisory in nature, such as the amount of processing time remaining. These types of windows cannot be moved, closed, iconized, or resized by the user.

- **8.3.5.3 Moving a window with a pointing device.** If a window is movable, and a pointing device is available, a user shall be able to move the window by moving the pointer into the window's title bar, pressing the appropriate button on the pointing device, and dragging the window to its new location. The window or an outline of the window shall move on the screen as the user moves the pointing device. Releasing the button shall result in the display of the window in the new location.
- **8.3.5.4 Moving a window using the keyboard.** Users shall be able to move movable windows using the keyboard by selecting the **Move** option from the window menu (the pointer will change to a move pointer, see exhibit 8.8.3.6.1) and then moving the window or an outline of the window using the arrow keys. Pressing the **Enter** key shall result in the display of the window in the new location.
- **8.3.5.5 Resize.** Where applicable, the application shall provide a **Resize** operation that enables a user to change the size of a window (see "discussion" in paragraph 8.3.5.2).
- **8.3.5.6 Resizing a window using a pointing device.** If a pointing device is available, a user shall be able to resize a resizable window by moving the pointer onto the window's border (the pointer will change to a resize pointer, see exhibit 8.8.3.6.1), pressing and holding the appropriate button on the pointing device, and dragging the border to the desired position. As the user moves the pointing device, the window or an outline of the window shall move with it, indicating the changing size of the window. When the user releases the button, the window

shall be displayed in its new size. Moving the pointer onto an edge (top, bottom, or sides) shall permit changing the size in one direction only. Moving the pointer onto a corner shall permit changing the size in two directions at once.

- **8.3.5.7 Resizing a window using the keyboard.** A user shall be able to change the size of a resizable window using the keyboard by (1) selecting **Resize** from the window menu, (2) selecting the border or corner to be moved using an arrow key or two keys simultaneously, and (3) moving the border or borders using the arrow keys. An outline of the resized window appears after each press of an arrow key. Pressing the **Enter** key shall result in the display of the window in its new size.
- **8.3.5.8 Iconize.** Where applicable, the application shall provide an **Iconize** operation that changes a window into an icon (see "discussion" in paragraph 8.3.5.2).
- **8.3.5.9 Iconizing a window using a pointing device.** If the window can be iconized, a user shall be able to change the active window into an icon by moving the pointer onto the **Iconize** control in the title bar, if present, and clicking the appropriate button or by selecting **Iconize** from the window menu.
- **8.3.5.10 Iconizing a window using the keyboard.** If the window can be iconized, a user shall be able to change the active window into an icon using the keyboard by selecting **Iconize** from the window menu.
- **8.3.5.11 Restoring an icon using a pointing device.** A user shall be able to restore an iconized window by moving the pointer onto the icon and "double-clicking" (clicking the appropriate button twice at the proper rate of speed). When the window appears, it shall be in the same location and size as when it was iconized. Its status shall be active.
- **8.3.5.12 Restoring an icon using the keyboard.** A user shall be able to restore an iconized window using the keyboard by (1) moving the location cursor to the desired icon and (2) pressing the **Enter** key. When the window appears, it shall be in the same location and size as when it was iconized. Its status shall be active.
- **8.3.5.13 Maximize.** If the window can be resized, the application shall provide a **Maximize** operation that enlarges a window to its maximum size.

**Discussion.** Unless constrained by the application, a maximized window will fill the entire working area of the screen.

- **8.3.5.14 Close.** If the window can be closed, the application shall provide a **Close** operation that enables a user to close a window, that is, to remove it from the screen. If processing is occurring, or if unsaved data have been generated in the window, users shall

be required to confirm the action before the window is removed from the screen and processing stops.

- **8.3.5.15 Next window.** The application should provide a **Next window** operation that enables a user to assign input focus to the "next" open window.

**Discussion.** The concepts of "next" and "previous" windows imply an ordering of the open windows. Unless required otherwise, the order in which they were opened is recommended.

- **8.3.5.16 Previous window.** The application should provide a **Previous window** operation that enables a user to assign input focus to the "previous" open window.

**Discussion.** The concepts of "next" and "previous" windows imply an ordering of the open windows. Unless required otherwise, the order in which they were opened is recommended.

- **8.3.5.17 Moving and copying objects.** Users should be able to perform the following operations on objects in a window:
  - a. move an object to another location in the same window,
  - b. move an object to a different window,
  - c. copy an object and place the copy at a different location in the same window,
  - d. copy an object and place the copy in a different window.

### 8.3.6 Window navigation

- **8.3.6.1 Software navigation aids.** The user should be able to switch between software modules in a quick, easy manner, using an interface such as a tree or organization chart. This function should include the ability to select a menu or submenu directly, without going through intermediate steps.
- **8.3.6.2 Open window map.** When using an overlapping window structure, applications should provide a user-requested iconic or text map indication of all open windows to allow the user to easily identify all open (especially hidden) windows.
- **8.3.6.3 Active designation from open window map.** Users should be given the capability to designate the active window through the iconic or text open window map by highlighting the window representation.
- **8.3.6.4 Expanded window explanation of open window map.** If possible, the user should be able to query an open window map for expanded information (such as the date it was created, its

size, or a description of the subject or application) on the file or application operating in the window.

- **8.3.6.5 Window forward function with window map.** When an iconic or text map is provided for determining the numbers and names of open windows in an overlapping system, the user should be able to bring a window forward from the map without having to resize or move other windows.

## 8.3.7 Menus

### 8.3.7.1 General

- **8.3.7.1.1 Applicable criteria and guidelines.** Menus, options, and selection in windows shall conform to the criteria and guidelines in section 8.4.1.
- **8.3.7.1.2 Wording of options.** Options should be:
  - a. phrased as commands to the computer rather than as questions to the user,
  - b. in the vocabulary of the user, not that of the developer,
  - c. tersely worded, preferably a single word, and
  - d. displayed in mixed case letters, with only the first letter of the first word and acronyms capitalized.

### 8.3.7.2 Mnemonics and keyboard accelerators

- **8.3.7.2.1 Mnemonics.** Each option in a menu should have a mnemonic.
- **8.3.7.2.2 Single letter mnemonic.** The mnemonic for an option shall be a single letter, different from any other mnemonic in the menu. That letter shall be underlined.

**Definition.** A **mnemonic** is a single letter that a user can type to select an option in a menu when the menu is displayed.

**Discussion.** The preferred letter is the first letter, however, if that letter is used as another mnemonic in the menu or associated menus, another letter may be used. It is also preferred that the mnemonic for an option use the same letter in the keyboard accelerator (see paragraph 8.3.7.2.5) if there is one and it includes a letter. For example, "S" might be the mnemonic for a "Save" option, and the simultaneous pressing of **Ctrl** and the letter "S" might be its keyboard accelerator.

- **8.3.7.2.3 Selecting an option using its mnemonic.** If the options in a menu have mnemonics and the menu has input focus, a user shall be able to select an option by simply typing its mnemonic.
- **8.3.7.2.4 Selecting an option in a menu bar using its mnemonic.** Users shall be able to select an option in the menu bar of a window that has input focus (see paragraph 8.3.4.3.1) by typing the mnemonic (same as paragraph 8.3.2.4.3).
- **8.3.7.2.5 Keyboard accelerators.** Applications should provide keyboard accelerators (or "hot keys") for frequently selected menu options. When provided, they should appear right-justified on the same line as the option, separated by enough space to appear visually distinct.

**Definition.** A **keyboard accelerator** is a key or simultaneous combination of keys that a user can type to select an option in a menu without having to display the menu. Both mnemonics and accelerators are shortcuts that a user can type from the keyboard.

- **8.3.7.2.6 Selecting an option in a menu using its accelerator.** If a menu has accelerators, a user shall be able to select an option in the menu by typing its accelerator.
- **8.3.7.2.7 Case sensitivity of mnemonics and keyboard accelerators.** Mnemonics and keyboard accelerators shall not be case sensitive, that is, upper and lower case letters shall be equivalent.
- **8.3.7.2.8 Consistency of mnemonics and keyboard accelerators.** Mnemonics and keyboard accelerators shall be consistent throughout an application and related applications.
- **8.3.7.2.9 Displaying mnemonics and accelerators.** Mnemonics and accelerators shall be displayed as part of the menu option. Exhibit 8.3.7.2.9 shows one way of indicating mnemonics (the underscored letters) and accelerators (the key combinations at the right).

**Exhibit 8.3.7.2.9** Example of mnemonics and accelerators

<u>U</u> ndo	Alt + Backspace
C <u>u</u> t	Shift + Del
<u>C</u> opy	Ctrl + Ins
<u>P</u> aste	Shift + Ins
C <u>l</u> ear	
<u>D</u> elete	Del

### 8.3.7.3 Pull-down menus

- **8.3.7.3.1 Title.** The title of a pull-down menu shall be the option on the menu bar with which the pull-down menu is associated. It shall be unique in the menu bar, and, to the extent possible, shall describe or identify the options in the pull-down menu.

**Definition.** A **pull-down menu** is a menu associated with an option on a menu bar.

- **8.3.7.3.2 Presentation of options.** The options in a pull-down menu should be displayed one option per line. Thus the menu should be wide enough to accommodate the longest option and its keyboard accelerator, if present (see also paragraph 8.4.1.5.1).
- **8.3.7.3.3 Ordering and grouping of options.** The ordering and grouping of options in a pull-down menu shall conform to the criteria and guidelines in section 8.4.1.
- **8.3.7.3.4 Navigation and selection.** Navigation and selection of options in pull-down menus shall conform to the criteria and guidelines in section 8.4.1.
- **8.3.7.3.5 Pull-down menu options.** The options in a pull-down menu shall be one of five types (see also paragraphs 8.1.11.1.9 and 8.4.1.1.5):
  - a. Commands that are executed as soon as they are selected.
  - b. Names of windows or forms that will be displayed. These options shall be identified by a special symbol, for example, an ellipsis (...).
  - c. Names of other menus. These options shall be identified by a special symbol, for example, an arrow (→) or triangle (▷) that points to the location where the menu will appear.
  - d. Sets of exclusive options. These options shall be identified by special symbol, for example, a filled circle (●) for the selected option and an open circle (○) for the unselected options.
  - e. Sets of nonexclusive options. These options shall be identified by special symbols, for example, a marked square (☒) for the selected option(s), if any, and an open square (☐) for the unselected option(s), if any.
- **8.3.7.3.6 Number of options.** The number of options in a pull-down menu should not be more than ten or less than three (same as paragraph 8.2.11.1.6).
- **8.3.7.3.7 Distinguishing unavailable options.** If a pull-down menu contains options that are temporarily unavailable, the unavailable options shall be displayed but clearly distinguishable from available options. For example, unavailable options might be displayed at reduced intensity ("grayed out") (same as paragraphs 8.1.11.1.8, 8.1.11.2.7, and 8.4.1.1.6).

#### 8.3.7.4 Scrolling menus

This section contains criteria and guidelines for scrolling menus.

**Definition.** A **scrolling menu** is a menu, usually containing many options, that does not display all of the options at once, but includes a scroll bar that permits the sequential display of all options. Scrolling menus are also called "list boxes" and "scrolling lists."

- **8.3.7.4.1 Format.** The displayed options in a scrolling menu shall be arranged vertically, with one option per line, and the scroll bar shall be placed at the right of the displayed options. If the menu has a title, it shall appear above the displayed options, and it shall be easily distinguishable from the options.
- **8.3.7.4.2 Order of options.** The options in a scrolling menu should be ordered in a way that minimizes user navigation. For example, they might be ordered by expected frequency of use or in chronological or other sequential order. If no other order seems appropriate, they should be ordered alphabetically.
- **8.3.7.4.3 Number of options displayed.** If a menu contains more than ten options, approximately ten of them should be displayed, and a scroll bar should be provided to permit users to see and select the remaining options. If the options are ordered by expected frequency of use, the highest frequency options should be displayed, and the most frequent option highlighted (same as paragraph 8.4.1.1.3).
- **8.3.7.4.4 Display of all options in a scrolling menu.** All the options in a scrolling menu shall be available for explicit and complete display through scrolling. It shall be obvious to users that there are more options than are visible (same as paragraph 8.4.1.1.4).

**Discussion.** The presence of a scroll bar may be sufficient to indicate the existence of additional options.

- **8.3.7.4.5 Search capability.** If a scrolling menu is large, for example, 50 options or more, the application should provide a search capability that would allow users to type a few characters of the option and search for those characters.
- **8.3.7.4.6 Editing scrolling menus.** If beneficial for task performance, users should be able to edit scrolling menus, adding, deleting, and changing options.

### 8.3.8 Text edit windows

- **8.3.8.1 Text cursor.** The text cursor shall be an I-beam in insert mode and a box over a character in replace mode. The text cursor shall flash at a rate between 2 and 5 Hz. If the text object containing the text cursor loses input focus, the cursor shall stop flashing. If the text object regains input focus, the cursor shall return to normal brightness and resume flashing (same as paragraph 8.4.2.4.1).
- **8.3.8.2 Text cursor location.** When a window first receives input focus, the text cursor shall be placed in the text area where typing is most likely to occur. If the cursor disappears from view when its window loses focus, the cursor shall reappear at the same location when the window regains focus (same as paragraph 8.4.2.4.2).

- **8.3.8.3 Moving the text cursor.** Users shall be able to move the text cursor within and among text entry areas using both the pointing device and the keyboard. If a user moves the pointer into a text entry area and clicks the appropriate button, the text cursor shall appear at the pointer location (same as paragraph 8.4.2.4.3).
- **8.3.8.4 Text cursor display.** The pointer shall change to an I-beam (text cursor) only when the pointer moves into an area in which text entry is possible. Users shall not be able to move the text cursor into areas in which text entry is not possible.
- **8.3.8.5 Pointer visibility.** The pointer should disappear when a user begins typing and reappear when the user stops typing or when he or she moves the pointing device.
- **8.3.8.6 Insert mode.** Insert should be the default text entry mode; the **Backspace** key should delete the character to the left of the text cursor; and the Delete key should delete the character to the right of the cursor.
- **8.3.8.7 Manipulating text.** Users should be able to highlight blocks of text and perform such operations as moving, copying, and deleting on the blocks.
- **8.3.8.8 Text entry.** Text entry shall be possible only when the text cursor is visible in a location that can accept text entry.

## 8.3.9 System-level windows

### 8.3.9.1 System log on and log off

- **8.3.9.1.1 System access through log on process.** If necessary, each system shall implement a log on procedure that users must complete before they can access any system functions. If the system is unavailable for log on, it shall display a message, if possible, stating the system status and when it will be available.

**Discussion.** Systems may restrict the applications available to a user based on the users log on identification. Alternatively, systems may require users to log on to individual applications or groups of applications.

- **8.3.9.1.2 Log on screen or window.** If a system uses a log on procedure, a log on screen or window should be displayed automatically as soon as a user completes any required startup or power-up procedures (same as paragraph 8.2.2.2.1 for screens).
- **8.3.9.1.3 Log on procedure.** The log on procedure shall conform to paragraph 8.2.2.2.2.



- **8.3.9.1.4 System startup.** During system startup, the system should display a message stating its unavailability, change the pointer shape to a watch or hourglass, and disable the keyboard and pointing device. When startup is complete, the message should be removed, the pointer returned to its normal shape, and the keyboard and pointing device enabled. If appropriate, the system should provide messages containing such information as average system response time or known periods of unavailability.
- **8.3.9.1.5 User-initiated log off.** Users shall be able to initiate a log off by selecting **Log off** from the system menu (see section 8.3.9.3). If a user has generated any data without saving them, the system shall prompt him or her to save the data, if desired, and confirm the log off. If applicable, the system shall notify the user of any applications that are still running and require the user to log off the application(s) before confirming a system log off. When log off is complete, the initial log on window shall be displayed.
- **8.3.9.1.6 Automatic log off.** If a system includes an automatic log off due to user inactivity, a standard elapsed time (for example, 15 minutes) should be designated for automatic log off. This time interval should be modifiable by the user. During periods of inactivity, the system should display a message stating the action necessary to avoid automatic log off (for example, a keystroke or movement of the pointing device). In addition, an auditory signal should be provided at intervals during the period of inactivity. If automatic log off occurs, any unsaved data should be saved, and a message should be displayed indicating that automatic log off has occurred and providing the name of the file in which data have been saved, if applicable.

### 8.3.9.2 The system window

- **8.3.9.2.1 Appearance.** The system window shall appear when system startup is complete. It shall occupy the entire screen.
- **8.3.9.2.2 System window components.** The system window shall contain:
  - a. a system title bar that extends across the top of the screen,
  - b. a system menu bar located just below the system title bar, and that also extends across the screen, and
  - c. an area available for the display of application windows that occupies the remainder of the screen.

The system title bar shall contain a centered title that identifies the system. It may also include optional components such as status indicators and a date and time display. The system menu bar shall list the titles of menus that are available at the system level. These menus shall provide access to the application level programs available to the user. The application area of the

system window may contain icons that represent application windows or action icons common to all applications.

- **8.3.9.2.3 System window behavior.** Users shall not be able to move or resize the system window, nor shall they be able to obscure the system title bar or system menu bar. Appropriate system-level menu options shall always be available.

### 8.3.9.3 The system menu

- **8.3.9.3.1 Integration of applications into system-level menus.** The system designers shall decide whether the functionality provided by an application will be available as an entire menu, as a group of options within a menu, or as a single menu option, and whether the application will be available from the system-level menu or from within another application.
- **8.3.9.3.2 System window menu bar.** The set of options that appears in the system menu bar should describe the overall functionality of the system. The menu bar should contain no more than ten options plus **Help**. The options should begin at the left margin and extend to the right with enough space between them so that they can be read easily and to accommodate the longest options in the pull-down menus. Each option (and each option in the pull-down menus) should contain a mnemonic to permit selection from the keyboard.
- **8.3.9.3.3 Consistency across systems.** To the extent possible, menu bar options and their order should be the same across systems. If the same application appears in different systems, it should have the same name in each system and should be available in the same system-level menu.
- **8.3.9.3.4 Access to Help.** When users are working in an application, they should be able to select **Help** from the system menu bar at any time.
- **8.3.9.3.5 Navigation aid.** Each system should include a navigation aid that provides an overview of the system and allows users to navigate quickly to a particular part of the system. For example, the system might provide a graphical representation of the system that would allow a user to select one part and have the appropriate window displayed on the screen. This navigation aid should be accessible through **Help**.

### 8.3.9.4 System support

- **8.3.9.4.1 System menu.** Each system should provide a system menu that includes options to end a session, print screens, review system status, define user preferences, manage alerts, change a password, access peripherals, and perform file management. These options should be available through a **System** option in the system menu bar.

- **8.3.9.4.2 Utilities menu.** Each system should include the resources required to support the functionality provided by the system, including such resources as word processing, spreadsheets, and electronic mail. These resources should be available through a **Utilities** option in the system menu bar.
- **8.3.9.4.3 Additional support functions.** Each system should provide:
  - a. a screen saver,
  - b. the ability to suspend a session without completely logging off (the system would continue all active processes, but not allow interaction until a user logs on again), and
  - c. easy identification of and navigation among all open windows.
- **8.3.9.4.4 User-specified settings.** System designers should decide which interface parameters users will be allowed to set, provide a default setting for each, and provide users access to these settings. The designers should decide which of these settings will remain in effect for the current session only and which will be in effect whenever that user logs on. Users should be able to review the parameters and reset them at any time during a session. At the end of a session, any parameters having settings that apply only to the current session should be reset to their default values.

### 8.3.10 Application-level windows

Current versions of Apple Macintosh™ do not support applications windows per se. In the Macintosh windowing system, the system-level window changes its menu bar according to the application that is running. Therefore, there is no distinction between system-level windows and application-level windows in the Macintosh environment.

#### 8.3.10.1 Window organization

- **8.3.10.1.1 Components of application windows.** All application windows shall have a border or frame, a title bar, a window menu control, and a working area. If appropriate, they may also contain a window menu bar, a command entry area, and a message area. If present, these components shall be located as follows:
  - a. The title bar shall extend across the top of the window.
  - b. The window menu control shall be at the left end of the title bar.
  - c. The menu bar shall extend across the window just below the title bar.

- d. The working area shall occupy all the space inside the border that is not occupied by another component.
  - e. The command entry area shall extend across the bottom of the window just above the message area, if there is one.
  - f. The message area shall extend across the bottom of the window.
- **8.3.10.1.2 Window title.** The window title shall appear centered in the window's title bar. It shall be in mixed-case letters, and it shall be unique in the application. The title shall be as informative as possible, describing the purpose of the window, and, if appropriate, including the name of the application. If a window is displayed as a result of the selection of an option in a menu, the title of the window shall be the same as the wording of the option.
  - **8.3.10.1.3 Window menu bars.** Window menu bars should contain no more than ten options plus **Help**. The options should begin at the left margin and extend to the right, with **Help** located consistently. Options in window menu bars should not duplicate options in the system menu bar.
  - **8.3.10.1.4 Names of menu bar options.** Each menu that appears as an option in a menu bar should have a title that is unique in the application. If the same menu occurs in different windows, it should have the same title in each. Each title should have a mnemonic.
  - **8.3.10.1.5 Push buttons.** The top, bottom, or sides of the working area should be reserved for push buttons that provide actions that can be taken in the window. The push buttons should be displayed in a horizontal or vertical row centered with the window. Button order should be consistent throughout an application. Buttons should be ordered from left to right (or top to bottom for vertical rows) according to one or more of the following principles:
    - a. by frequency of use, with the most frequent at the left or top,
    - b. by sequence of use, with the first to be used at the left or top, or
    - c. with positive actions at the left or top and negative or canceling actions at the right or bottom.
  - **8.3.10.1.6 Help button.** If **Help** does not appear in a window menu bar, the window should have a **Help** button. It should be located at the bottom right corner of the working area of the window.
  - **8.3.10.1.7 Action icons.** If an application window includes action icons, they should be arranged along the left margin of the

window. The number of action icons in a window should not exceed 20.

- **8.3.10.1.8 Action icons bound to window.** If an application window includes action icons, a user shall not be able to move the icons outside the window.
- **8.3.10.1.9 Message area.** Noncritical application messages to users should be presented in a message area at the bottom of the window. The left side of the area should be used for routine messages, simple help, and status messages. The right side of the area should be used to present information about the window, such as the name of an object or the page number. Primary windows should have message areas.

**Discussion.** The message area may be a dedicated area or it may be an area that is used temporarily when a message is presented, but is available for other uses otherwise.

- **8.3.10.1.10 Consistency in window organization.** The windows in an application and related applications shall have a consistent organizational scheme for the key elements of the windows. Individual windows shall contain only those elements appropriate to the particular task, but the elements shall be consistent from window to window throughout the application.
- **8.3.10.1.11 Control windows (dialog boxes).** Sets of controls that perform similar or related functions should be grouped and presented together in a control window (also called a dialog box). A control window should have a border and a title that clearly indicates the function of the set of controls. The individual controls should be arranged in an orderly and logical manner. If scroll bars are needed, vertical scroll bars should be located at the right, and horizontal scroll bars should be located at the bottom of the area to be scrolled. If a control is temporarily unavailable, it should be displayed at reduced intensity. Exhibit 8.3.10.1.11 is an example of a control window.

### 8.3.10.2 Message windows

This section contains criteria and guidelines for several special purpose message windows (also called message boxes). These include request windows, error message windows, information message windows, confirmation message windows, warning message windows, and "working" message windows.

**Definition.** A **message window** is a secondary window that provides users (1) noncritical information, (2) progress information about lengthy processes, (3) alerts to unusual events, and (4) warnings of potential dangers. Message windows may be modal or modeless.

- **8.3.10.2.1 Allowed operations.** Users should be able to **Move** a message window.
- **8.3.10.2.2 Disallowed operations.** Users should not be able to **Iconize** or **Resize** message windows.

**Exhibit 8.3.10.1.11** Example of a control window

- **8.3.10.2.3 Message windows -- contents.** Message windows should contain (1) a title, (2) a symbol that indicates the type of message, (3) the message itself, and (4) one or more push buttons.

**Discussion.** Some examples of possible symbols for different types of messages are:  $\emptyset$  for error messages, **i** for information messages, **?** for request and confirmation messages, **!** for warning messages, and a watch, clock, or hourglass for "working" messages.

- **8.3.10.2.4 Message wording.** The messages in message windows should use language that is meaningful to users and should require no further documentation or translation. Messages should focus on what needs to be done, not on what was done wrong.
- **8.3.10.2.5 Message windows -- size and location.** Message windows should be just large enough to display the information required. They should be distinctive in appearance and appear in a standard location on the screen.
- **8.3.10.2.6 Request message windows.** A request message window should be used when it is necessary to request information from a user before processing can proceed. A request message window should contain: (1) a title, (2) a question symbol (**?**), (3) a message indicating the information required, (4) a text field, if appropriate, and (5) all of the following push buttons that apply in the order in which they are listed: **OK, Apply, Reset, Cancel, and Help.**

- **8.3.10.2.7 Error message windows.** An error message window should contain: (1) an error symbol ( $\emptyset$ ), (2) a message, and (3) the following push buttons in the order listed: **OK**, **Cancel**, and **Help**.
- **8.3.10.2.8 Information message windows.** An information message window should be used to convey noncritical information that requires acknowledgement by users. (The message area described in paragraph 8.3.10.1.9 should be used for messages that do not require acknowledgement.) An information message window should contain: (1) an information symbol (**i**), (2) a message, and (3) the following push buttons in the order listed: **OK** and **Help**.
- **8.3.10.2.9 Information message window behavior.** Information message windows shall not appear to the user to interrupt processing by the application. That is, if the application interrupts processing, it shall be transparent to the user.
- **8.3.10.2.10 Confirmation message windows.** Confirmation message windows should be used to request clarification of a previous user action. The application should suspend processing until the user responds to the window. The window should contain: (1) a question symbol (?), (2) a message, and (3) one of the following sets of push buttons in the order listed: {**Yes**, **No**, and **Help**} or {**Yes**, **No**, **Cancel**, and **Help**}.
- **8.3.10.2.11 Warning message windows.** Critical messages warning users of destructive consequences of actions should be displayed in warning message windows, and processing should be suspended until a user responds. Warning message windows should contain: (1) a warning symbol (!), (2) a message, and (3) one of the following sets of push buttons, in the order listed: {**Yes**, **No**, and **Help**} or {**OK**, **Cancel**, and **Help**}.
- **8.3.10.2.12 Accompanying audible warning signals.** Warning messages should be accompanied by an audible signal (see also paragraph 8.5.4.3).
- **8.3.10.2.13 "Working" message windows.** If the processing time resulting from a user action will exceed 2 seconds, the system shall display a "working" message window. The display of the window shall not interrupt processing. The message window shall remain on display until processing is completed or until the user iconizes the window or cancels the process. The window shall be removed automatically when processing is completed. Working message windows shall contain: (1) a working symbol (for example, a clock, watch, or hourglass), (2) a message, and (3) one of the following sets of push buttons, in the order listed: {**OK** and **Help**}, {**OK**, **Cancel**, and **Help**}, {**OK**, **Stop**, and **Help**}, or {**OK**, **Pause**, **Resume**, **Stop**, and **Help**}.
- **8.3.10.2.14 Progressive working messages.** If processing time will be lengthy, the window should be updated to indicate the status of processing (for example by displaying messages like

"5% completed") or should include a scale showing the proportion of processing completed.

### 8.3.10.3 Use of color in windows

- **8.3.10.3.1 Applicable criteria and guidelines.** The use of color in windows shall conform to the criteria and guidelines in section 8.3.4.
- **8.3.10.3.2 Consistent use of color.** Color shall be used consistently throughout an application and related applications.
- **8.3.10.3.3 Limited use of color.** Color should be used in the working area of a window primarily as redundant coding and as a means of highlighting critical elements.
- **8.3.10.3.4 Coding and status colors.** Users and applications shall not be able to change colors for coding and status of facilities, services, or equipment such as alarms or alerts.
- **8.3.10.3.5 User preferences.** If appropriate to the functionality of an application, users should have the option of selecting from a variety of color sets as a user preference setting for aspects of an application that do not involve coding or status.

### 8.3.10.4 Text in windows

- **8.3.10.4.1 Contrast.** In general, text should be displayed as black characters on a white or light background (same as 8.4.2.1.3 and 8.5.2.1.2).
- **8.3.10.4.2 Dot matrices.** If characters are formed using dot matrices, the matrix should be at least seven dots wide and nine dots high.
- **8.3.10.4.3 Minimum character height.** The minimum height of displayed characters should be 1/200 of the viewing distance. For example, for a viewing distance of 800 mm (31.5 in), characters should be at least 4 mm (0.16 in) high (same as paragraph 8.2.3.7).

**Discussion.** In some cases, a screen will be read by a person standing behind a seated user. The character height would be based on the maximum viewing distance, not the "normal" or "typical" distance.

- **8.3.10.4.4 User-selectable font size.** If an application cannot satisfy the range of viewing requirements with a single text font, the application should provide text font size as a user-selectable option.
- **8.3.10.4.5 Arabic vs. Roman numerals.** If information elements in a window will be numbered, Arabic numerals should be used, not Roman numerals.



- **8.3.10.4.6 Capitalization.** Text should be presented in a combination of upper- and lower-case letters, following standard capitalization rules (see, for example, the U. S. Government Printing Office *Style Manual*).
- **8.3.10.4.7 Acronyms.** Acronyms should be used only if they are significantly shorter than the term they represent and if they will be commonly understood by users. Acronyms should be displayed in all upper-case letters.
- **8.3.10.4.8 Abbreviations.** Abbreviations should be used only if they are significantly shorter than the word they represent and if they will be commonly understood by users. They should be as short as possible, consistent with uniqueness in the application.
- **8.3.10.4.9 Formation of acronyms and abbreviations.** New acronyms and abbreviations shall be formed according to the rules in the U.S. Government Printing Office *Style Manual*.
- **8.3.10.4.10 Dictionary of acronyms and abbreviations.** If acronyms or abbreviations are used, an on-line dictionary or help screen shall be provided.
- **8.3.10.4.11 Consistent structure for noneditable text.** Each type of noneditable text, for example, titles, labels, and instructions, displayed in windows should have a consistent grammatical structure. For example, all instructions might be complete, imperative sentences.
- **8.3.10.4.12 Vocabulary.** The words used in all noneditable text shall be task-oriented and familiar to users.
- **8.3.10.4.13 Sentence structure.** In continuous text, sentences should be simple, affirmative, and active, as opposed to complex or compound, negative, and passive.
  - **Exception.** Negative sentences are appropriate for stating prohibitions, for example, "Do not exit the application before saving your entries."
- **8.3.10.4.14 Punctuation.** Normal punctuation rules should be followed. Contractions and hyphenation should be avoided.
- **8.3.10.4.15 Sequences.** Sequences of events or steps shall be presented in the proper order.
- **8.3.10.4.16 Referents.** The referents for pronouns such as "it" and "they" shall be easily identifiable.
- **8.3.10.4.17 Case conversion.** If an application requires that all text be in one case, for example upper-case, the application should accept typed upper- and lower-case letters as equivalent and automatically convert the "improper" case to the "proper" one.

- **8.3.10.4.18 Wild card search characters.** If an application provides a character string search capability, it should include the following "wild card" characters:
  - a. @ should represent any single upper- or lower-case alphabetic character. For example, abc@d would retrieve abcad, abcEd, and abczd; it would not retrieve abc7d or abcd.
  - b. # should represent any single numeric character. For example, 123#4 would retrieve 12334, 12394, and 12304; it would not retrieve 123554 or 123A4.
  - c. ? should represent any single alphanumeric character (that is, any upper- or lower case alphabetic character, any number, or any punctuation mark). For example, abc?d would retrieve abcAd, abc5d, and abc,d; it would not retrieve abcxxd.
  - d. \* should represent zero or more alphanumeric characters. For example, abc\*d would retrieve abcd, abcad, and abcjf75/kld.

### 8.3.11 Window management considerations

- **8.3.11.1 Initial window contents and organization.** The initial contents and organization of a window should permit a user to accomplish the window's purpose easily and efficiently.
- **8.3.11.2 Initial size.** If possible, the initial size of a window should permit the display of all its contents. The minimum size should permit the display of the title and menu bar, if any.
- **8.3.11.3 Initial placement.** The initial placement of a window should be based on: (1) the importance of the information (critical information should be placed in the center of the user's field of view), (2) information already displayed that should not be obscured, (3) the distance from the current pointer location (pointer movement should be minimized), and, (4) if applicable, information already displayed that is relevant to the window.
- **8.3.11.4 Resizing.** When a user resizes a window, only the border(s) affected should move, not the objects within the borders. If a window becomes too small to display its objects, vertical or horizontal scroll bars or both should be added.

**Discussion.** If appropriate, the size to which a window can be reduced may be restricted so that its objects cannot be obscured.

- **8.3.11.5 Mode of windows.** Developers should specify the mode (modal or modeless) of each secondary window (see section 8.3.4.4).

### 8.3.12 Task-specific windows

#### 8.3.12.1 Help windows

Specific guidelines pertaining to on-line help are available in section 8.6.1.

- **8.3.12.1.1 Help availability.** Both system-level and application-level help should be available to users. Help should be provided in the following ways:
  - a. As a menu title in the system menu bar. This level of help should describe system capabilities and provide information on how to use help. It may include an on-line tutorial for users and a system navigation aid (see paragraph 8.3.9.3.5).
  - b. As a menu title in an application menu bar. This level of help should include general information on application functionality. It may include an on-line, cross-referenced index so that users can obtain information about particular windows, actions, and commands. If the application uses action icons, it may provide help through an action icon.
  - c. As a push button or check box in a window. This level of help should provide information about the actions that can be taken in the window.
  - d. As a message in the message area of a window. This level of help should explain how to complete the initiation of an action.
  - e. As a function available from the keyboard. This level of help should provide information about the object in a window that has input focus. The information may be displayed in a message window or in the message area of the window in which the object appears.
- **8.3.12.1.2 Help window elements.** A help window should include: (1) a title that identifies the contents, (2) a working area, scrollable, if necessary, that displays the help information, and (3) an **OK** push button to remove the window.

**Discussion.** It is desirable that users be able to print part or all of the contents of a help window.

- **8.3.12.1.3 Size and placement.** Help windows should be wide enough to display complete lines of text and long enough to display all the lines, if practical. The window should be placed so that it does not obscure the object it describes. Users should be able to **Move** and **Resize** help windows.
- **8.3.12.1.4 Help information.** A help window should describe the object or explain the steps required to initiate the action about which help was requested.

- **8.3.12.1.5 Wording of help information.** The appearance and wording of help information should conform to the criteria and guidelines in section 8.6.9.4. In addition, words or terms likely to be of interest to users should be highlighted, and steps should be numbered and presented as separate paragraphs.
- **8.3.12.1.6 Removal of help windows.** Help windows should be removed from the screen when: (1) a user activates the **OK** push button, or (2) the object or window about which help was requested is removed, iconized, or closed.

**Discussion.** It is desirable that users be able to keep a help window displayed while continuing to work with the application.

### 8.3.12.2 Data entry windows

- **8.3.12.2.1 Data entry window elements.** A data entry window should contain: (1) a title that describes the purpose or contents of the window, (2) a set of labeled fields, (3) vertical or horizontal scroll bars or both, if the contents do not fit in the window's working area, and (4) controls appropriate to the task.

**Definition.** A **data entry window** is a window that contains a set of labeled fields for entering, changing, and deleting data. It may also contain labeled data display fields, which a user cannot change.

- **8.3.12.2.2 Data window organization.** The organization of a data entry window should be consistent with the task it represents. For example, data fields should be arranged by sequence of use, frequency of use, or importance, with related fields grouped together and separated from unrelated fields. If users will enter data from hard copy forms, the data entry field organization should correspond to that of the hard copy.
- **8.3.12.2.3 Multipage data entry windows.** If the contents of a set of data entry fields do not fit the window's working area,
  - a. the window should provide users the ability to page, scroll, or both through the entire set, and
  - b. if the fields are arranged in rows, columns, or both, the labels of the rows or columns should remain in place when the rows or columns scroll or page.
- **8.3.12.2.4 Push buttons in data entry windows.** If a data entry window contains push buttons, the buttons should be placed in a row at the bottom of the working area, visually separated from the data fields.
- **8.3.12.2.5 Controls for data entry windows.** A data entry window should contain the controls appropriate to the task.

**Examples.** If the contents require more than one page, the window would contain controls for paging. It might also be appropriate to include controls for clearing entries and restarting data entry.

- **8.3.12.2.6 Help on data entry fields.** Users should be able to obtain help about data entry fields.
- **8.3.12.2.7 Data entry fields.** Fields in data entry windows shall conform to the criteria and guidelines in section 8.4.2.2.
- **8.3.12.2.8 Labeling data fields.** The labels for data entry fields shall conform to the criteria and guidelines in section 8.4.3.3.
- **8.3.12.2.9 Navigation in data entry windows.** Navigation in data entry windows shall conform to the criteria and guidelines in section 8.4.3.5.
- **8.3.12.2.10 Data entry and editing in data entry windows.** The entering and editing of data in data entry windows shall conform to the criteria and guidelines in section 8.4.3.7.
- **8.3.12.2.11 Saving entered data.** When a user has finished making entries in a data entry window, he or she shall be able to save the entries by taking an explicit action such as selecting a **Save** menu option or activating an **Apply** or **OK** push button. Users shall be able to save their entries at any time during data entry.

### 8.3.12.3 Text windows

- **8.3.12.3.1 Width of a text window.** A window intended for the display of textual information should be wide enough to display an entire line of anticipated text without horizontal scrolling. The text should automatically wrap to the next line based on the width of the window.
- **8.3.12.3.2 Vertical scroll bars.** If the entire text document does not fit in the current window, the window shall have a vertical scroll bar or a similar mechanism (positioned either on the right or left side of a window) so that users can view the entire document. The current position in the document (for example, the current page or line number) shall be displayed in a consistent location, such as in the window's message area.
- **8.3.12.3.3 Document operations.** As appropriate, users should be able to **Save, Retrieve, Edit, Delete, Print** (all or specified portions), and **Rename** documents.
- **8.3.12.3.4 Text manipulation.** If appropriate, users should be able to specify the format of a document (for example, set margins and tab stops) and to select the font type, size, and style for text. Automatic line breaks and page breaks should be provided. Users should be able to assign page numbers as well as have them supplied automatically. If the displayed text is not

formatted as it will be when printed, users should have the ability to view the text in its final format.

- **8.3.12.3.5 Search and replace capabilities.** Users should have both search and search-and-replace capabilities in text windows.

#### 8.3.12.4 Map windows

- **8.3.12.4.1 Map window elements.** A map window should include: (1) a title, (2) identifying information such as coordinates, area, and scale, (3) the map itself, (4) a continuous coordinate indicator that states the pointer location, and (5) appropriate controls.
- **8.3.12.4.2 Map orientation.** All maps should be displayed in the same orientation, usually with north at the top.
- **8.3.12.4.3 Consistent label position.** Labels should be positioned consistently with respect to the feature they identify, for example, to the left of or below the feature, but without obscuring important information.
- **8.3.12.4.4 Label legibility.** Labels should remain legible at all map resolutions.
- **8.3.12.4.5 Color coding key.** If a color overlay is available for a map, a color coding key that explains each color should be displayed whenever the overlay is displayed. Users should be able to display the key without displaying the overlay.
- **8.3.12.4.6 Symbols and color codes.** Symbols and color codes shall conform to the criteria and guidelines in sections 8.5.4.5 and 8.5.4.8.
- **8.3.12.4.7 User control of map appearance.** Users should be able to customize a map window to conform to the task being performed as follows:
  - a. pan and zoom (see section 8.5.8.3) ,
  - b. return to initial appearance,
  - c. define a "home" position and return to this position easily,
  - d. move the window (see paragraphs 8.3.5.3 and 8.3.5.4),
  - e. define the map appearance (for example, assign colors to areas) (see section 8.5.4.5 for color coding),
  - f. select the objects that appear on the map, and
  - g. change the appearance of critical information.

- **8.3.12.4.8 User editing of labels and overlays.** If authorized, users should be able to add, edit, reposition, and delete labels and overlays on a map.
- **8.3.12.4.9 "Reading" a map.** Users should be able to determine the distance and bearing between any two points on a map.
- **8.3.12.4.10 Crowded, cluttered maps.** If symbols on a map are densely packed or overlapped, users should have a way to select the desired symbol easily and accurately (for example, by selecting it from a pop-up menu). Users should be able to distinguish among symbols that represent coincident points and to obtain information that will allow them to resolve ambiguities among symbols.
- **8.3.12.4.11 User control of automatic updating.** Users should be able to select the categories of information that will be updated automatically and to specify the frequency and rate at which the information will be updated. If appropriate, users should also be able to temporarily stop and then resume updating.

### 8.3.12.5 Windows for sending and receiving electronic messages

- **8.3.12.5.1 Message handling windows.** Windows intended for sending and receiving electronic messages shall conform to the general criteria and guidelines for data entry windows given in section 8.6.12.2.
- **8.3.12.5.2 Message window fields and headers.** Message handling windows should include a basic set of labeled fields, for example, an addressee field, a "copy to" field, a subject field, and a message field. If appropriate, a variety of preformatted forms corresponding to standard message formats should be provided.
- **8.3.12.5.3 Field support.** If possible, the application should provide information to help a user make a proper entry in a field, for example, the addressee field might be supported by a pop-up menu of potential addressees.
- **8.3.12.5.4 Distribution lists.** Users should be able to create, store, retrieve, edit, and use distribution lists of commonly used addressees or groups of addressees.
- **8.3.12.5.5 Message transmission.** Users should be able to transmit electronic messages easily, for example, by activating a **Send** or **Transmit** push button.
- **8.3.12.5.6 Delayed or unsuccessful transmission.** If an electronic message cannot be sent immediately, the system should automatically queue the message; users should not have to monitor transmission or make repeated attempts to send a message. Users should be notified if a message cannot be

transmitted. Users should be able to cancel or abort any message that has not yet been transmitted.

- **8.3.12.5.7 Message status information.** Users should be able to specify what sort of feedback they want about message transmission, and a log of this information should be maintained automatically.
- **8.3.12.5.8 Notification of message arrival.** Users should be notified when a high priority electronic message arrives. For example, at log on, users might be given a list of messages that have arrived since they last read a message, and during a session, an alert of some sort might be displayed in the system window. Notification should not interfere with ongoing system use. If messages differ in priority, the notification should reflect that priority.
- **8.3.12.5.9 Queuing and logging incoming messages.** Incoming electronic messages should be automatically queued by time of receipt and message priority, if any, and a log of this information should be maintained.
- **8.3.12.5.10 Incoming message operations.** Users should be able to display a summary of new electronic messages addressed to them and any old messages they have not deleted. They should be able to **Display**, **Save**, and **Delete** individual messages. When a message is displayed, it should appear in a text window, with all the capabilities of these windows, such as scrolling and printing.

## 8.4 Data entry

Data entry refers to user actions involving the input of data into a computer system, and the system's response to the user actions. The data entry methods covered in this section are: (1) selection from menus, (2) form filling, (3) direct manipulation, and (4) the keyboard entry of text. Additional topics covered in this section include the entry of tabular and graphic data, and the validation of entered data.

### 8.4.1 Menus

Menus are often useful in data entry, for example, to list files that may be retrieved, or to list the acceptable entries for a field in a form. Menus of this sort are often too long to display in their entirety. In that case, a portion of the menu is displayed and a scrolling capability is provided.

#### 8.4.1.1 General

- **8.4.1.1.1 Consistent style.** Menus throughout an application shall conform to a single style of interface, for example, OSF/Motif™, Open Look™, Microsoft Windows™, or Macintosh™ (same as paragraph 8.1.11.1.2).
- **8.4.1.1.2 Consistent wording and ordering.** Menus and options that appear in different displays and contexts shall be consistent in wording and order (same as paragraph 8.1.11.1.3).



- **8.4.1.1.3 Scrollable menus.** If a menu contains more than ten options, approximately ten of the options should be displayed, and a scroll bar or similar mechanism should be provided to permit a user to see and select the remaining options. If the options are ordered by expected frequency of use, the highest frequency options should be displayed, and the most frequent option highlighted (same as paragraph 8.3.7.4.3).
- **8.4.1.1.4 Display of all options in a scrolling menu.** All the options in a scrolling menu shall be available for explicit and complete display through scrolling. It shall be obvious to users that there are more options than are visible (same as paragraph 8.3.7.4.4).

**Discussion.** The presence of a scroll bar may be sufficient to indicate the existence of additional options.

- **8.4.1.1.5 Distinguishing types of options.** If a menu contains options of different types, for example, options that lead to other menus and options that are values that can be entered in fields, the types shall be distinguishable. For example, options that lead to other menus might be followed by a triangle that points to where the subsequent menu will appear (▷ or ▽). A menu option that requires additional information from the user might be followed by an ellipsis (...) (same as 8.1.11.1.9; see also 8.1.11.1.8).
- **8.4.1.1.6 Distinguishing unavailable options.** If a menu contains options that are temporarily unavailable, the unavailable options shall be displayed but clearly distinguishable from available options. For example, unavailable options might be displayed at reduced intensity ("grayed out") (same as paragraphs 8.1.11.1.8, 8.1.11.2.7, and 8.3.7.3.7).
- **8.4.1.1.7 Instructions.** Instructions pertaining to menus shall appear in a help window and in a consistent location on the screen (same as paragraph 8.1.11.1.10).
- **8.4.1.1.8 Menus distinct from other displayed information.** Menus that appear in displays that also contain other objects or information shall be distinct from the other objects or information (same as paragraph 8.1.11.1.13).

### 8.4.1.2 Hierarchical menus

- **8.4.1.2.1 When to use.** Hierarchical menus should be used if the number of options is more than ten and the options can be organized into a meaningful hierarchy.

**Note.** A hierarchical structure may be more cumbersome and keystroke intensive than a longer, single-level structure. Thus, if a long list of options is obviously and logically organized, it will be easier to use than a hierarchical structure. For instance, consider a list of

type sizes numerically ordered or a long list font alternatives logically organized.

- **8.4.1.2.2 Applicable rules.** If hierarchical menus are used for data entry, they shall conform to the rules in section 8.1.11.3.

### 8.4.1.3 Pull-down menus

Pull-down menus have limited applicability in data entry, but they may be useful for such activities as retrieving files.

**Definition.** A **pull-down menu** is a menu that appears when a menu bar option is selected.

- **8.4.1.3.1 When to use.** Pull-down menus should be used rather than pop-up menus if the position of the cursor on the screen is not important for information or option retrieval (same as 8.1.11.5.1).

**Discussion.** The advantage of pull-down menus over pop-up menus is that pull-down menus always have a visual cue in the form of a menu bar.

- **8.4.1.3.2 Consistent location.** Pull-down menus shall appear immediately below or adjacent the option whose selection leads to their appearance (same as paragraph 8.1.11.5.2).

### 8.4.1.4 Pop-up menus

Pop-up menus can be very useful in data entry. They can present to a user the permissible entries for a field, thus (1) eliminating the need for the user to remember the entries, (2) preventing invalid entries, and (3) eliminating potential typing errors.

**Definition.** A **pop-up menu** is a menu that is associated with a particular object on a display, for example, a pop-up menu listing acceptable command options close to the immediate work area. This is particularly useful for large displays, where the work site may be relatively removed for the menu bar.

- **8.4.1.4.1 When to use.** Pop-up menus should be used only if it is critical to the application that users be able to access functions without moving the pointing device. They should not be the only method for accessing operations, since the operations are hidden from view, requiring users to remember where they are and how to access them (same as paragraphs 8.1.11.6.1 and 8.2.1.8.5).
- **8.4.1.4.2 Pop-up menu location.** A pop-up menu shall appear in a location that is coordinated with the location of the pointer (same as paragraph 8.1.11.6.2).
- **8.4.1.4.3 Selection highlighting.** If an option in a pop-up menu remains on display after it has been selected, it should remain highlighted (same as paragraph 8.1.11.6.3).

**Explanation.** This method is preferred to holding the button down while moving the cursor and releasing it to make a selection. The deliberate click method is less prone to error.

### 8.4.1.5 Format

- **8.4.1.5.1 Presentation of options.** The options in a menu should be presented in a single vertical column, aligned and left-justified (see also paragraph 8.1.11.2.1).
- **8.4.1.5.2 Consistent menus and options.** If the same menu or option appears in different displays within an application, it shall be consistent in wording and ordering (same as paragraph 8.1.11.2.2).
- **8.4.1.5.3 Logical grouping of menu options.** If applicable, the options in a menu shall be presented in logical groups (same as paragraph 8.1.11.2.3).
- **8.4.1.5.4 Ordering groups of options.** Groups of options in a menu shall be ordered logically. If there is no apparent logical ordering, the groups shall be ordered by their importance or expected frequency of use (same as paragraph 8.1.11.2.4).
- **8.4.1.5.5 Ordering options within a group or menu.** If a group of options or a menu contains a small number of options, the options shall be ordered by logical sequence or frequency of use. If a group or menu contains a very large number of options, the options shall be ordered alphabetically (same as paragraph 8.1.11.2.5).

### 8.4.1.6 Selecting options

- **8.4.1.6.1 Equivalence of input devices.** The system or application shall provide a user the ability to use any of the input devices available to select a menu option. For example, if a user has both a pointing device and a keyboard available, he or she shall be able to use either to select an option (same as paragraph 8.1.11.7.1).
- **8.4.1.6.2 Menu selection by pointing.** If menu selection is the primary interactive method, and especially if selections are made from extensive lists of options, selection by pointing device should be provided (same as paragraph 8.1.11.7.6).
- **8.4.1.6.3 Method of selecting by pointing.** The method for selecting an option by pointing should be that of moving the cursor onto the desired option and clicking the "select" button on the pointing device.

**Explanation.** This method is preferred to holding the button down while moving the cursor and releasing it to make a selection. The deliberate click method is less prone to error.

- **8.4.1.6.4 Initial cursor position for pointing devices.** If a user must select among displayed options using a pointing device, the cursor shall be placed on the default option when the display appears (same as paragraphs 8.1.6.10 and 8.1.11.7.2).

- **8.4.1.6.5 Initial cursor position for keyboards.** If a user must select among displayed options using a keyboard, the cursor shall be placed on the default option in the control entry area (with that control entry area having implicit input focus) when the display appears (see "discussion" in paragraph 8.3.4.3.1) (same as paragraphs 8.1.6.11 and 8.1.11.7.3).
- **8.4.1.6.6 Feedback for menu selection.** If no computer response is immediately observable when a user selects an option, the software shall provide some other acknowledgment of the selection. For example, the software might display a watch, hourglass, or a message stating the delay remaining or completed (same as paragraph 8.2.11.7.4).
- **8.4.1.6.7 Number of selections per menu.** A user should be allowed to select only one option from a menu. If the menu is divided into groups a user should be able to select only one option from each group, although users may be able to select multiple files from a menu (same as paragraph 8.1.11.7.9).

## 8.4.2 Text

### 8.4.2.1 General

- **8.4.2.1.1 Text input area.** The system shall provide a sufficient screen working area that permits users to enter and edit text.
- **8.4.2.1.2 Distinctive appearance.** Text entered by a user shall be clearly distinguishable from system supplied text that also appears on the screen.
- **8.4.2.1.3 Contrast.** In general, text should be displayed as black characters on a white or light background (same as 8.3.10.4.1 and 8.5.2.1.1).
- **8.4.2.1.4 Multiple input devices.** If the system provides more than one input device, for example, both a pointing device and a keyboard, a user should not have to alternate frequently between devices. One solution is to provide both devices the ability to perform all operations.
- **8.4.2.1.5 Multiple cursors.** Multiple cursors shall be avoided unless needed for user tasks. If more than one cursor is provided, each shall be easily distinguishable from the other(s), and the status of each (active or inactive) shall be easily distinguishable.
- **8.4.2.1.6 Cursor movement.** When entering and editing text, users shall be able to move the cursor freely within a displayed page to specify items for change, and to make changes directly in the text.
- **8.4.2.1.7 Enhanced cursor movement.** As applicable, users should be able to move the cursor by units of character, line, paragraph, and page.

- **8.4.2.1.8 Frequently used text blocks.** If applicable, a system should provide users a means for storing and retrieving frequently used blocks of text, for example, distribution lists.
- **8.4.2.1.9 Spell checker.** If an application involves extensive entry of text, it should provide an on-line spell checker. The spell checker should include abbreviations and acronyms or the ability to supplement the dictionary.

### 8.4.2.2 Text entry and editing

- **8.4.2.2.1 Insert mode as default.** The default mode for text entry should be insert, not replace. That is, when a user types, the new text should be added at the insertion point, and the cursor and any existing text should move to the right.
- **8.4.2.2.2 Action of Backspace and Delete.** The **Backspace** key should delete the character to the left of the text cursor and the **Delete** key should delete the character the cursor is on. If in the application, the cursor rests between characters (such as an I-beam), the **Delete** key will delete the character to the right of the text cursor.
- **8.4.2.2.3 Editing operations.** Easy to use editing operations should be provided, including **Cut**, **Copy**, **Paste**, and **Undo**.
- **8.4.2.2.4 Searching text.** A character string search capability should be provided that searches the text for a specified string and places the cursor at the first match found. The case (upper or lower) of the characters should be ignored unless specified otherwise by the user.
- **8.4.2.2.5 Global search and replace.** A global search and replace capability should be provided. For example, a user should be able to command the system to locate all occurrences of the string "respond" and replace them with the string "response."
- **8.4.2.2.6 Editing units of text** Users should be able to specify units of text for the editing operations. The units should include characters, words, lines, paragraphs, and pages.
- **8.4.2.2.7 Highlighting units of text.** As appropriate, units of text that are designated for an editing operation, such as **Cut** or **Copy**, should be highlighted or indicated in some other way.

### 8.4.2.3 Formatting

- **8.4.2.3.1 Text format.** The system should provide a default format for standard text input. If it also provides users the ability to define their own formats, it should include a means for them to store those formats for future use.

- **8.4.2.3.2 Page formatting.** The system should provide users an easy means for specifying page formats. Formatting should include margins and tabs.
- **8.4.2.3.3 Line breaks.** The system should provide automatic line breaks and automatic word-wrap when text reaches the right margin. The system should also provide for user-specified line breaks.
- **8.4.2.3.4 Justification of text.** Unless otherwise specified by a user, text should be left-justified (ragged right edge) with consistent spacing between words as it is entered. Right-, center-, and full-justification should be provided as user options.
- **8.4.2.3.5 Hyphenation.** The system should provide automatic hyphenation of words at a user's request. The default mode should be no hyphenation.
- **8.4.2.3.6 Page breaks.** The system should provide automatic page breaks and user-specified page breaks. Users should be able to specify a minimum number of lines of a paragraph that will appear at the bottom or top of a page ("widow-orphan protection").
- **8.4.2.3.7 Page numbering.** Automatically incremented page numbering should be provided. By default, page numbering should begin with one, but users should be able to override the default by specifying a beginning page number.

#### 8.4.2.4 Text cursor in windows

- **8.4.2.4.1 Text cursor.** The text cursor shall be an I-beam in insert mode and a box over a character in replace mode. The text cursor shall flash at a rate between 2 and 5 Hz. If the text object containing the text cursor loses input focus, the cursor shall stop flashing. If the text object regains input focus, the cursor shall return to normal brightness and resume flashing (same as paragraph 8.3.8.1).

**Discussion.** **Input focus** means that the indicated location, window, or object in the text field is currently "active" and, unless the user changes this active state, that will be the object or location that will be acted upon by the next text editing or entry transaction.

- **8.4.2.4.2 Text cursor location.** When a window first receives input focus, the text cursor shall be placed in the text area where typing is most likely to occur. If the cursor disappears from view when its window loses focus, the cursor shall reappear at the same location when the window regains focus (same as paragraph 8.3.8.2).
- **8.4.2.4.3 Moving the text cursor.** Users shall be able to move the text cursor within and among text entry areas using both the pointing device and the keyboard. If a user moves the pointer

into a text entry area and clicks the appropriate button, the text cursor shall appear at the pointer location (same as paragraph 8.3.8.3).

- **8.4.2.4.4 Control entries distinguishable from text.** If applicable, control entries that are displayed in text (for example, paragraph indentation symbols and printer commands, such as begin and end underline) should be distinguishable from the main text.

## 8.4.3 Forms

Form filling as a means of data entry is especially appropriate if some flexibility is needed (such as the inclusion of optional as well as required items), if users will have moderate training, or if computer response might be slow.

### 8.4.3.1 General

- **8.4.3.1.1 Title.** Each form shall have a title. The title shall appear at the top of the form.
- **8.4.3.1.2 Consistency.** Forms, labels, fields, messages, and instructions that appear on different displays shall be as consistent as possible within an application and among related applications.
- **8.4.3.1.3 Field help.** Help shall be provided for fields.

**Discussion.** Some help might be provided automatically when the cursor arrives in a field, such as an explanatory message or a menu of acceptable entries. Other ways context-sensitive help might be provided include: (1) providing a **Help** operation that provides help on the field that contains the cursor, and (2) providing help on the field when a user moves the pointer onto the field label and clicks the appropriate button.

### 8.4.3.2 Fields

- **8.4.3.2.1 Appearance.** Fields shall have a distinctive appearance and distinct limits, for example, a series of underscores, or a rectangle, perhaps in inverse video, that clearly distinguish fields from each other and from other objects and information on the screen.
- **8.4.3.2.2 Field length.** Data entry fields should be of fixed length, even if the entries may be of variable length. If useful to the user, a field should give a cue as to its length, for example by using separated underscores ( \_ \_ \_ \_ \_ ).
- **8.4.3.2.3 Entry does not overwrite field delineators.** Fields shall not be designated by characters that are overwritten as a user enters data.
- **8.4.3.2.4 Unfilled portion of field.** If a field accepts variable length entries, users shall not have to remove or fill any unneeded portion.

- **8.4.3.2.5 Required fields.** If a form has one or more required fields, the user shall have to make an entry in each required field to be able to complete the form in its intended way. The save button shall be displayed as unavailable until all of the required fields have been filled (see also paragraphs 8.4.3.8.3 and 8.4.3.8.4).

**Examples.** A user might be given an error message if he or she tries to leave a required field without making an entry, or a user might be given an error message if he or she tries to **Save** a form without making an entry in all required fields.

- **8.4.3.2.6 Optional fields distinct from required fields.** If a form has both optional and required fields, the two types of fields shall be easily distinguishable.

**Examples.** One way to do this would be to use different label terminators for the two types of fields, for example, the labels of optional fields might be followed by a colon (:), and the labels of required fields might be followed by a slash (/) (see paragraph 8.4.3.3.5). Another way to do this would be to use different appearances for the fields themselves, for example, a required field might appear as underscores ( \_\_\_\_\_ ), and an optional field as a row of dots (.....).

- **8.4.3.2.7 Intrafield separators.** If possible, fields provided for data that include separators or some sort of formatting, such as slashes separating the month, day, and year in dates, or a decimal point separating dollars and cents, shall include the separators or formatting as part of the field.

**Examples.** A field for a date might appear:

DATE: \_\_/\_\_/\_\_.

A field for a telephone number might appear:

TELEPHONE NUMBER: (\_\_\_\_) \_\_\_\_-\_\_\_\_.

### 8.4.3.3 Field labels

- **8.4.3.3.1 Field labels.** Every data field shall have a label that uniquely identifies the field.

**Discussion.** A single label is sufficient for a series of fields of the same type arrayed in a row or column.

- **8.4.3.3.2 Descriptive labels.** A label should specify or suggest the entry that goes into the field. Numbers and other arbitrary codes should not be used as field labels.

**Discussion.** Complete words are preferred as labels, but predefined terms, codes, and abbreviations may be acceptable.



- **8.4.3.3.3 Terms used in labels.** Labels for data fields should be composed of terms that are familiar to the user, relevant to the topic of the form, and easily understood by a typical user.
- **8.4.3.3.4 Labels distinct from other information.** Labels shall be distinct from data entries and from other information on the screen, for example, by differing in font or size.
- **8.4.3.3.5 Label terminator.** Field labels shall terminate with a special symbol that designates the end of the label and the beginning of the field. A colon (:) is frequently used for this purpose. If the label is to the left of the field, the terminator shall be followed by a blank space that separates it from the beginning of the field.
- **8.4.3.3.6 Consistent location.** Labels shall be located consistently with respect to their fields.

**Discussion.** The preferred location for a label is to the left of or above its field. If a form contains both single label-field pairs and arrays (rows or columns) of fields with a single label, the location of labels for the single label-field pairs may be different from the labels for the arrays of fields.

- **8.4.3.3.7 Unit of measurement.** If a field entry involves a unit of measurement, the unit shall be included as part of the label or field.

**Examples.**

COST: \$\_\_\_\_.\_\_\_\_

LENGTH (ft): \_\_\_\_\_

- **8.4.3.3.8 Alternative units.** If measurements might be in different units, for example, inches or millimeters, users shall not have to transform them at the time of data entry.

**Discussion.** This problem might be solved by providing a field for each unit of measurement, and the user selects the correct field. Another solution might be to have one field for the quantity and another field for the unit of measurement.

- **8.4.3.3.9 Labels not editable.** Field labels shall not be editable by users, at least not while they are in form-filling mode.

#### 8.4.3.4 Layout

- **8.4.3.4.1 Correspondence between screen and document.** If users will transfer data from hard copy documents, the screen layout shall correspond to the hard copy in the order and grouping of data items. It is desirable that the displayed form look as much like the source document as possible.

- **8.4.3.4.2 Layout with no source document.** If input is not from source documents or hard copy forms, data fields shall be ordered and grouped logically, using sequence, frequency of use, importance, and functional associations as organizing principles.
- **8.4.3.4.3 Multipage forms.** If a form is too large to fit in the available screen area, it should be broken into "pages," and each page should be labeled with its number and the total number, for example, **Page 1 of 3**.

### 8.4.3.5 Navigation

- **8.4.3.5.1 Initial cursor position.** When a form first appears, the cursor shall be placed automatically in the first position of the first field.
- **8.4.3.5.2 Easy cursor movement.** The system shall provide one or more easy ways to move the cursor among fields. If the primary means of entering data in fields is the keyboard, the cursor movement methods shall include keyboard keys such as the **Tab** key(s) and the arrow keys. If a pointing device is available, a user shall be able to move the cursor to any field by moving the pointer into the field and clicking the appropriate button. If both a keyboard and pointing device is available, cursor movement shall be allowed using either device.
- **8.4.3.5.3 No automatic movement.** The cursor should not be moved automatically among fields; movement should occur only upon explicit user action, such as pressing the **Tab** key.

**Exception.** There may be cases in which automatic movement is desirable. For example, if skilled users enter numerous entries of fixed length, it may be preferable to move the cursor automatically to the next field when the current field is filled. The danger is that a missed or extra character may result in erroneous entries in many fields before the user notices.

- **8.4.3.5.4 Navigation only to fields.** In general, a user shall be able to move the cursor only into fields and onto control objects on the screen; that is, a user shall not be able to move the cursor onto labels or other nondata-entry areas on the screen.
- **8.4.3.5.5 Protected fields.** If a form has protected fields, a user shall not be able to move the cursor into a protected field.

**Explanation.** A field might be protected from some users and not from others. Other fields might be reserved for the display of computed values.

- **8.4.3.5.6 Moving to "next" and "previous" fields.** If the fields in a form will be traversed sequentially, a user should be able to move the cursor to the "next" field by pressing the **Tab** key, and to the "previous" field by pressing the **Shift** and **Tab** keys simultaneously.

**Discussion.** This sort of movement requires a predefined "path" through a form that specifies which field is "next" and which is "previous." Presumably such a path will traverse each field once and only once in a systematic way, for example, from left to right and top to bottom.

- **8.4.3.5.7 Navigation with a pointer.** If fields may not necessarily be traversed in a set order, a pointing device, in addition to keyboard, should also be available for selecting fields.

### 8.4.3.6 Defaults

- **8.4.3.6.1 When to use.** If a form is expected to have the same entry in a particular field most of the time, that entry should appear in that field as a default entry when the form first appears.
- **8.4.3.6.2 Displaying default values.** A field that has a default value shall have that value appear in the field automatically when the form appears.
- **8.4.3.6.3 Replacing default values in fields.** If an entry is normally made in a field by typing, a user shall be able to replace a default value by moving the cursor into the field and typing. The default value shall disappear immediately after the first keystroke. This action shall not affect the default value itself; that is, the next time the form appears, the same default value shall appear in the field.

**Exception.** An exception to this rule is when an application permits a user to select whether he or she wants the application to retain the last entry or a previous default value as the current default setting.

### 8.4.3.7 Data entry and editing

- **8.4.3.7.1 Unfilled spaces.** Users shall not have to move a space at a time over unfilled spaces in variable length fields.
- **8.4.3.7.2 Leading and trailing zeros.** A user shall not have to enter leading or trailing zeros to fill a field.
- **8.4.3.7.3 Justification of entries.** If a user makes an entry that does not fill a variable length field, the system shall justify the entry automatically when the cursor leaves the field. Unless otherwise required by processing or display requirements, justification shall be as follows:
  - a. Alphanumeric input shall be left justified.
  - b. Integer numerical data shall be right justified.
  - c. Decimal numerical data shall be decimal point justified.

- **8.4.3.7.4 Interrupt capabilities.** Users shall have the ability to use **Backup** (see paragraph 8.1.4.3), **Cancel** (see paragraph 8.1.4.4), and **Restart** (see paragraph 8.1.4.8) actions to edit a form at any time prior to the final "completion" action.
- **8.4.3.7.5 Editing entries.** Users shall be able to move the cursor to any unprotected field and change any entry prior to taking a final "completion" action.
- **8.4.3.7.6 Explicit "completion" action.** A form shall not be removed from display until the user takes an explicit "completion" action, such as pressing the **Enter** key.

#### 8.4.3.8 Error management

- **8.4.3.8.1 Easy error correction.** Users shall be able to correct errors easily on a character-by-character and field-by-field basis.
- **8.4.3.8.2 Unacceptable entries.** If a field has a set or range of acceptable values, and a user enters an unacceptable value, the system shall either:
  - a. provide an error message when the user tries to leave the field and not move the cursor from the field, or
  - b. allow the user to continue moving through the form and, when the user tries to perform the "completion" action, provide an error message and move the cursor to the field in error.
- **8.4.3.8.3 Omitted fields.** If a user fails to make an entry in a required field, the system shall either:
  - a. provide an error message when the user tries to leave the field and not move the cursor from the field, or
  - b. allow the user to continue moving through the form and, when the user tries to perform the "completion" action, provide an error message and move the cursor to the field in error.
- **8.4.3.8.4 Deliberate omissions.** If applicable, a system or application should provide a special symbol that a user can enter in a required field; this symbol will allow the user to defer the required entry and continue with the remainder of the form.

#### 8.4.4 Direct manipulation

In a graphical user interface, a major type of interactive dialog is direct manipulation. In a direct manipulation dialog, the user controls the interface with the computer by acting directly on "objects" on the display screen. An object may be an icon, menu option, symbol, button, or dialog box.

- **8.4.4.1 Drag transfer.** If a system provides direct manipulation, a user should be able to move and copy data and objects by first marking the data or object, if necessary, then placing the pointer

on it, holding down the appropriate button on the pointing device, and dragging it to the desired location.

- **8.4.4.2 Data and object transfer.** If a system provides direct manipulation, a user should be able to move and copy data and objects by first marking the data or object, if necessary, then transferring the data or object to a temporary storage, and then transferring the data or object from the temporary storage to its new location.

## 8.4.5 Tables

- **8.4.5.1 When to use.** If sets of data must be entered sequentially or if data are keyed row by row, a tabular format should be used.
- **8.4.5.2 Labels.** Each row and column shall be uniquely and informatively labeled, and the labels shall be distinct from the data cells.
- **8.4.5.3 Leading and trailing zeros.** Users shall not have to type leading zeros (before numbers to the left of the decimal point) or trailing zeros (following numbers to the right of the decimal point).
- **8.4.5.4 Automatic justification.** Data typed into a cell of a table shall be justified automatically when the user moves the cursor to the next cell. Justification shall be as follows (see also paragraph 8.4.3.7.3):
  - a. Alphanumeric input shall be left justified.
  - b. Integer numerical data shall be right justified.
  - c. Decimal numerical data shall be decimal point justified.
- **8.4.5.5 Navigation with the Tab key.** The **Tab** key shall move the cursor to the first position of the next cell to the right of its current position, or if the current position is in the last cell in a row, it shall move the cursor to the first position of the first cell in the next row. Similarly, pressing **Shift** and **Tab** simultaneously shall move the cursor to the first position in the next cell to the left of the current position, or if the current position is in the first cell in a row, it shall move the cursor to the first position in the last cell in the preceding row.
- **8.4.5.6 Navigating with a pointing device.** If a pointing device is available, a user shall be able to move the cursor to any cell by moving the pointer into the cell and clicking the appropriate button.
- **8.4.5.7 Large tables.** If a table is too large to fit in the available display area, as much of the top left portion shall be displayed as will fit when it is first displayed, and appropriate scroll bars or similar mechanisms shall be provided. Scroll bars may be provided on the right or left side, and on the bottom or top.

- **8.4.5.8 Labels in scrolling tables.** When a user scrolls a large table, the row or column labels that remain relevant shall not scroll, but shall remain in place. For example, if the rows scroll up or down, the column labels shall remain in place.

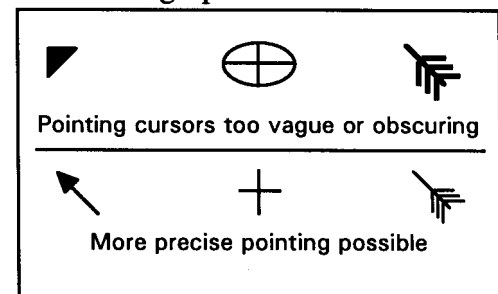
## 8.4.6 Entry of graphics

### 8.4.6.1 General

- **8.4.6.1.1 Pointing device.** The system should provide a pointing device for entering and manipulating graphic data. The pointing device should also be capable of system control.

- **8.4.6.1.2 Graphics cursor.** The cursor for creating graphics displays should be (1) distinctive, (2) easy to position, and (3) have a point that can be used to select and manipulate small graphic objects. Some good and bad examples of graphics cursors are given in exhibit 8.4.6.1.2.

**Exhibit 8.4.6.1.2** Examples of better and worse graphics cursors



- **8.4.6.1.3 Graphics cursor operation.** A graphics cursor operation should have a movement (pointing) component and an activation component. The movement component should position the cursor, and the activation component should activate the position to manipulate a display element, for example, selecting an object to move or drawing a line.
- **8.4.6.1.4 Validation on input.** To the extent possible, the system should validate graphic data as it is created. For example, the system should provide a message if a given value is outside the standard range.
- **8.4.6.1.5 Saving and retrieving graphic data.** An easy means shall be provided for saving and retrieving graphic data. Users shall be able to specify names for storing graphic data files and be able to view lists of these stored files.

### 8.4.6.2 Graphics entry and editing

- **8.4.6.2.1 Drawing lines.** The system should draw lines between user specified points and should support the drawing of rectangles, circles, arcs, ovals, and other figures.
- **8.4.6.2.2 Constraining lines.** Users should be able to constrain lines to be exactly vertical or horizontal. They should also be

able to specify that a line is perpendicular or parallel to another line.

- **8.4.6.2.3 Alignment grid.** The system should provide the capability of aligning objects on an invisible rule or grid structure at a user's request. Users should be able to specify grid intervals.
- **8.4.6.2.4 Alternate drawing methods.** If required by the task, alternate methods should be provided for drawing objects. For example, a circle might be drawn by specifying a center and a radius or diameter, or by specifying the size and location of an enclosing square.
- **8.4.6.2.5 Closure.** Users should be able to select automatic figure completion, that is, automatic closure of polygons. If separately drawn lines must connect at terminal points, the system should automatically make the connections.
- **8.4.6.2.6 Displaying attributes.** If desired by the user, object attributes should be displayed as selected. When displayed, they should not be represented as appended codes or by some other means.
- **8.4.6.2.7 Colors and patterns.** Users should be able to fill enclosed areas with colors or patterns.
- **8.4.6.2.8 Selectable elements and attributes.** Users should be able to select and edit display elements (such as lines) and their attributes (such as thickness) by pointing to and selecting from displayed examples.
- **8.4.6.2.9 Manipulating objects.** Users should be able to copy, rotate, and reverse (produce mirror images) objects both horizontally and vertically.
- **8.4.6.2.10 Editing objects.** User-selectable objects should be easily repositioned, duplicated, and deleted.
- **8.4.6.2.11 Scaling objects.** Users should be able to enlarge and reduce the size of objects.
- **8.4.6.2.12 Zoom capability.** A zoom capability should be provided to enlarge critical display areas.
- **8.4.6.2.13 Overlapping objects.** If it is desired by the user, the system should automatically merge objects and assign them precedence. For example, if two objects overlap, the system should obscure the overlapped portion of one of the objects.
- **8.4.6.2.14 Grouping objects.** The system should provide a means to group separate objects into a single grouped object that can then be treated as a single object.

### 8.4.6.3 User aids

- **8.4.6.3.1 Entering data for plotting.** When complex graphic data must be entered quickly, computer aids should be provided. For example, when plotting data within Cartesian coordinates, the system should automatically draw lines between the specified points of a function.
- **8.4.6.3.2 Plotting stored data.** The system should support automatic plotting of stored data.
- **8.4.6.3.3 Scaling graphic data.** The system should provide for automatic scaling of graphic data, and users should be able to modify system-generated scales.
- **8.4.6.3.4 Emergence of drawn objects.** Objects should emerge as they are being drawn. For example, when a user draws a line by moving a pen across a graphics tablet, the line displayed should emerge as the pen moves from the start point, increasing or decreasing in length and slope as the pen moves across and around the tablet.

### 8.4.7 Data validation

- **8.4.7.1 Format and content.** When possible, the system should automatically check data for format and content. For example, a date entered as February 31 should result in a content error message.
- **8.4.7.2 Valid data.** Valid data entries should be accepted and processed without any further user involvement, for example, if data pass validation tests, the user should not be prompted for a confirmation.
- **8.4.7.3 Invalid data.** Data and command entries that do not meet validation testing should result in a message asking for correction or confirmation.
- **8.4.7.4 Probable errors.** If validation testing detects a probable error, an error message should be displayed at the completion of the data entry, without interrupting an ongoing transaction.

## 8.5 Data display

Data display refers to the computer's presentation of information to the user. The emphasis in this section is on information presented on visual display terminals, but it also includes rules about auditory signals and displays.

### 8.5.1 General

- **8.5.1.1 Independence.** The content of each screen should stand on its own; users should not have to refer to a previous screen or remember essential information. For example, if the same information is needed in a series of screens, the system might



prompt the user to enter the information on the first screen and then automatically enter the information on subsequent screens.

- **8.5.1.2 Consistent with user expectations.** Data shall be displayed consistently, using standards and conventions familiar to users.
- **8.5.1.3 Consistent within applications.** Data display shall be consistent in word choice, format, and basic style throughout an application and related applications.
- **8.5.1.4 Whole data sets.** Whenever possible, users should be able to see the whole data set of interest, for example, an entire page, map, or graphic.
- **8.5.1.5 Information density.** Information density should be minimized in displays used for critical task sequences. For critical information, a minimum of one character space should be left blank vertically above and below critical information, and a minimum of two character spaces should be left blank to the left and to the right of the critical information.
- **8.5.1.6 Usable, essential data for a transaction.** The data needed for a transaction shall be displayed in a directly usable form, and only essential data shall be displayed.
- **8.5.1.7 User control.** Users should be able to control the amount, format, and complexity of displayed data, as necessary to meet task requirements.
- **8.5.1.8 Paper copy.** Users should be able to obtain a paper copy of the exact contents of an alphanumeric or graphic display in systems in which mass storage is limited, mass stored data can be lost by power interruption, or record keeping is required.
- **8.5.1.9 Date and time information.** If task performance requires or implies the need to assess the timeliness of information, the display should include time and date information associated with the data.
- **8.5.1.10 Familiar wording.** The wording of displayed data and labels should use familiar terms and the task-oriented language of the users; unfamiliar terms and language should be avoided.
- **8.5.1.11 Display formats.** The different elements of display formats shall be distinctive within a display, and consistent across displays.
- **8.5.1.12 Blank space.** Blank space should be used to structure a display.
- **8.5.1.13 Grouped information.** Groups of data items should be separated by blank space, lines, color coding, or other visually distinctive means.

- **8.5.1.14 Reserved area.** If the user's task requires frequent referral to or use of status or error messages, prompts, or command entries, those elements should be displayed in a reserved area at the bottom of the display.
- **8.5.1.15 Layout for comparisons.** If users must analyze sets of data for similarities, differences, or trends, displays should be formatted so that the data are grouped and aligned to facilitate these analyses.
- **8.5.1.16 Character-by-character comparisons.** If data fields are to be compared character-by-character, the fields should be vertically aligned.
- **8.5.1.17 Arranging data.** If applicable, data shall be arranged by sequence, function, importance, frequency of use, or by other means such as chronologically or alphabetically.
- **8.5.1.18 Context.** Context should be provided for displayed data. For example, if a user is changing parameters for a facility, relevant information concerning that facility should be displayed.
- **8.5.1.19 Multipage displays.** If a data set contains too much data for presentation in a single display, the data should be partitioned into separately displayable pages.
- **8.5.1.20 Partitioning data among pages.** Related data should appear on the same page. Relations among data sets should appear in an integrated display rather than being partitioned into separate pages.
- **8.5.1.21 Labeling pages.** Each page in a multipage data set should be labeled to show its relation to the others. For example, the first page of a three-page set might be labeled **Page 1 of 3**.

## 8.5.2 Text

### 8.5.2.1 General

- **8.5.2.1.1 Consistent wording and structure.** The wording and grammatical structure of displayed data and labels shall be consistent throughout an application and related applications.
- **8.5.2.1.2 Contrast.** In general, text should be displayed as black characters on a white or light background (same as 8.3.10.4.1 and 8.4.2.1.2).

### 8.5.2.2 Labeling

- **8.5.2.2.1 Distinct, unique, descriptive labels.** Each data group, message, or display should contain a distinct, unique, descriptive, and consistently worded title or label.
- **8.5.2.2.2 Alphanumeric labels.** The labels of screens should be alphanumeric. If they are not complete words, labels should be

abbreviations that are short enough (3 to 7 characters) or meaningful enough to be learned and remembered easily.

- **8.5.2.2.3 Consistency.** Label locations and formats should be consistent.
- **8.5.2.2.4 Spacing.** At least one blank line should separate a title from the body of a display.

### 8.5.3 Forms

- **8.5.3.1 Distinctive fields.** Data fields should be visually distinguishable from other displayed information (see also section 8.4.2).

### 8.5.4 Coding

#### 8.5.4.1 General

- **8.5.4.1.1 Meaningful codes.** If codes are used, they should be meaningful rather than arbitrary. For example, "male" and "female" might be coded "M" and "F," rather than "1" and "2."
- **8.5.4.1.2 When to use.** If coding is used, it should (1) differentiate items of information, (2) call a user's attention to changes in the state of a system, or (3) indicate important, hazardous, or critical information that requires user action.
- **8.5.4.1.3 Coding data categories.** Categories of data should be coded if a user must distinguish the data included in the categories rapidly and if the data items are distributed in an irregular way on the display.
- **8.5.4.1.4 Consistent coding.** Coding shall be consistent throughout an application and related applications.
- **8.5.4.1.5 Special codes.** Codes that are assigned a special meaning in a display should be defined at the bottom of the display.

#### 8.5.4.2 Alphanumeric coding

- **8.5.4.2.1 Supplemental use only.** Alphanumeric coding should not be used as the sole means to call attention to important or critical information. It may be used to supplement other coding schemes.
- **8.5.4.2.2 Case of letters.** Alphanumeric codes should use either upper case letters or lower case letters consistently; they should not use mixed cases.
- **8.5.4.2.3 Mixed letter and number codes.** If short codes contain both letters and numbers, the letters should be grouped together

and the numbers should be grouped together. For example, the code HW5 might be used rather than the code H5W.

- **8.5.4.2.4 Length of codes.** Arbitrary alphanumeric codes that are intended to be recalled by users should have no more than five characters and should be the same length.

### 8.5.4.3 Auditory coding

Coded auditory signals are appropriate to: (1) alert users to critical conditions or operations, (2) supplement visual signals, (3) present information in situations in which visual presentation is not feasible, and (4) provide feedback for control actuation, data entry, or the completion of timing cycles and sequences.

- **8.5.4.3.1 Acknowledging auditory signals.** A simple, consistent means of acknowledging auditory signals shall be provided. If the signal is noncritical, the acknowledgement action shall also turn the signal off.
- **8.5.4.3.2 User control.** Users shall be able to turn off noncritical auditory signals.
- **8.5.4.3.3 Delayed computer response.** If the computer response to a user request is greater than 15 seconds, the computer should provide an auditory signal when it responds.
- **8.5.4.3.4 Nature of auditory signals.** Different auditory signals should be easily distinguishable, for example, by varying in frequency, modulation, or both. Auditory signals should be intermittent rather than continuous.
- **8.5.4.3.5 Environmental compatibility.** The intensity, duration, and source location of an auditory signal should be compatible with the acoustic environment of the intended receiver as well as with the requirements of other personnel within acoustic range of the signal.

### 8.5.4.4 Brightness intensity coding

- **8.5.4.4.1 Consistent meaning.** Brightness coding shall have a single meaning throughout an application and related applications; for example, two brightness levels might mean **ON** and **OFF**, or **FAST** and **SLOW**, or **STANDBY** and **RUN**, but only one of the three.
- **8.5.4.4.2 Number of levels.** The number of brightness intensity levels used as codes shall not exceed three.
- **8.5.4.4.3 Brightness ratios.** Each level of brightness shall be separated from an adjacent level by a 2:1 ratio.

### 8.5.4.5 Color coding

Color coding can be helpful in differentiating classes of information in complex, dense, and critical displays. The color of the figure, background, and surrounding needs to be considered in order to provide the appropriate contrast and emphasis to the color coding.

- **8.5.4.5.1 Reserved meanings.** Color coding shall conform to the following reserved meanings:
  - a. Red shall indicate conditions such as "no-go," "error," "failure," or "malfunction."
  - b. Flashing red shall be used only to indicate emergency conditions requiring immediate user action to avert personnel injury or equipment damage.
  - c. Yellow shall indicate marginal conditions, alert users to situations where caution or rechecking is necessary, or notify users of an unexpected delay.
  - d. Green shall indicate that a monitored process or unit of equipment is within tolerance, that a condition is satisfactory, or that it is all right to proceed with an operation or transaction.
  - e. White shall indicate alternative functions or system conditions that do not have operability or safety implications.
  - f. Blue shall be used only as an advisory color.

**Discussion.** The use of colors to indicate primary meanings is also dependent on the color appearing against an appropriately contrasting background. For instance, white or light gray are appropriate for black text.

- **8.5.4.5.2 Color coding data categories.** If color is used to identify data categories, its use shall not conflict with other color coding conventions, or with those in paragraph 8.5.4.5.1.
- **8.5.4.5.3 Redundant use.** Color coding should not be used alone; it should be redundant to some other means of coding, such as symbols or size.
- **8.5.4.5.4 Use of color.** Colors shall be easily discriminable, and color shall be used conservatively and consistently, with each color representing only one category of displayed data.
- **8.5.4.5.5 Drawing attention.** Brighter or more saturated colors should be used to draw a user's attention to critical data.

#### 8.5.4.6 Flash coding

- **8.5.4.6.1 Limited use.** Flash coding shall be used only to indicate an urgent need for a user's attention.
- **8.5.4.6.2 Flashing rate.** The rate of flashing shall be in the range of three to five flashes per second, with equal on and off durations (see also paragraph 8.5.4.6.3).

- **8.5.4.6.3 Second flashing rate.** The number of flashing rates shall not exceed two. If two rates are used, one shall be slower than two flashes per second.
- **8.5.4.6.4 Displayed objects.** If a displayed object is to be flash coded, a flashing symbol adjacent to the object shall be used rather than flashing of the object itself.
- **8.5.4.6.5 Flash acknowledgement.** If flash coding is used, users should have a means of acknowledging the flashing. If appropriate, this acknowledgement should automatically stop the flashing.

#### 8.5.4.7 Line coding

Lines can be coded by such attributes as width or thickness, color, and pattern (that is, solid, dashed, dotted, and so on).

- **8.5.4.7.1 Length.** Quantities, such as velocity or distance, should be coded by line length.
- **8.5.4.7.2 Direction.** Spatial categorization in two dimensions, for example, an aircraft bearing, should be coded by line direction.
- **8.5.4.7.3 Number of coded lines.** The number of different lines used as codes should not exceed six.

#### 8.5.4.8 Symbol coding

- **8.5.4.8.1 Design of symbols.** To the extent possible, a symbol should be: (1) an analog of the object it represents, (2) in general use and well known to the users, or (3) based on established standards or conventional meanings.
- **8.5.4.8.2 Special symbols.** If special symbols, such as asterisks or arrows, are used, they shall be used consistently and with unique meanings throughout an application and related applications.

#### 8.5.4.9 Shape coding

- **8.5.4.9.1 Number of shape codes.** The number of different shapes used as codes shall not exceed 15.

#### 8.5.4.10 Size coding

- **8.5.4.10.1 Number of sizes.** The number of different sizes used as codes shall not exceed three.

### 8.5.5 Display of graphics

The goal of graphic presentation is to communicate information clearly and unambiguously, and to facilitate the detection of relationships among variables, comparisons among data sets, and the detection of trends in the data. This section contains criteria and guidelines for pictures and diagrams, as well as material relating to the construction of graphs and charts.

### 8.5.5.1 General

- **8.5.5.1.1 Complex formats.** Complex formats and embellishments that do not convey useful information shall be avoided.
- **8.5.5.1.2 Robustness.** Graphics should be designed to remain useful when reproduced or reduced in size.
- **8.5.5.1.3 Appropriateness of format.** The format shall be appropriate to the user's level of training and experience.
- **8.5.5.1.4 Only needed data.** Only the data needed by the user should be presented.
- **8.5.5.1.5 User selection of style.** If appropriate, users should be able to select alternative styles of presentation.
- **8.5.5.1.6 Value display.** If appropriate, users should be able to select a data point on a graph and obtain a display of the associated value or values.

**Discussion.** Users might also be given the option of choosing between tabular and graphical displays.

- **8.5.5.1.7 Consistency.** Graphics shall be consistent in design, format, and labeling throughout an application and related applications.
- **8.5.5.1.8 Labels.** Displayed graphics shall be clearly labeled.

### 8.5.5.2 Display of critical data

- **8.5.5.2.1 Reference values.** If users are required to make comparative evaluations against reference values, the reference values shall be displayed.
- **8.5.5.2.2 Displaying data values with graphics.** If precise readings of values are required, the actual data values should be displayed in addition to the plotted data.
- **8.5.5.2.3 Consistent labeling location.** If graphic data are labeled, the text shall appear in a consistent location in relation to the graphic elements.
- **8.5.5.2.4 Supplementary text.** Supplementary text within the framework of the graph should only be used to emphasize features of data requiring user attention or to enhance user understanding. The use of supplementary text should be minimized.

### 8.5.5.3 Creating and editing

Computer aids such as those listed in this section need to be provided for the entry and organization of complex graphic data.

- **8.5.5.3.1 Validation.** Data entered should be validated by the application software.
  - **Discussion.** Validation might include comparison with a range or set of values, or calculated or logical relationships with other entries.
- **8.5.5.3.2 Plotting aids.** If plotting formats are known, templates or other data entry aids should be provided.
- **8.5.5.3.3 Plotting stored data.** The application should provide automated or aided plotting and editing of stored data.
- **8.5.5.3.4 Automated production of scales.** The application should automatically adjust the range of scales or provide the user with automated aids for scaling graphic data.
- **8.5.5.3.5 Line drawing.** The application should provide users automated aids for drawing straight and curvilinear lines.
- **8.5.5.3.6 Automatic completion of polygons.** The application should provide automatic completion to users drawing polygons. That is, the application should automatically provide a line that connects the current cursor position to its starting point. A user should be able to make the provided line a permanent part of the figure.
- **8.5.5.3.7 Joining lines.** The application should provide automated assistance in joining lines.
- **8.5.5.3.8 Designating line segments.** Users should be able to identify and select line segments for moving and editing.
- **8.5.5.3.9 Grid references.** The application should provide optional, adjustable grid references to aid users in aligning horizontal and vertical lines.
- **8.5.5.3.10 User-specified rules.** Users should be able to specify rules for attributes, relationships, and design, and have the computer apply those rules automatically during the design process. For example, a user might specify that hand-drawn lines be straightened or that the angles between intersecting lines be adjusted.
- **8.5.5.3.11 Computer aids.** The application should provide prompts and computer-aided methods for drawing figures.
- **8.5.5.3.12 Scale changes.** The application should allow users to edit or create drawings in a large scale and then reduce them to the desired scale.
- **8.5.5.3.13 Basic operations.** The application should allow users to resize, copy, move, rotate, and produce mirror images of objects.



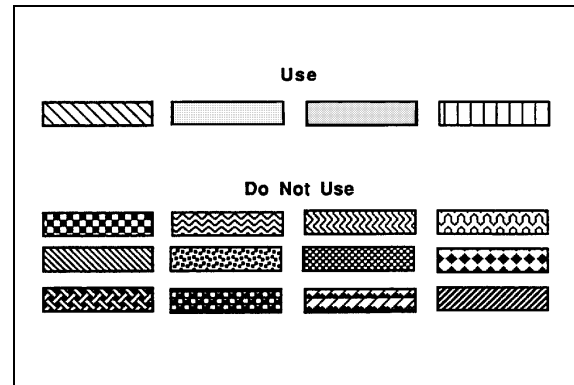
- **8.5.5.3.14 Grouping elements.** The application should allow users to select and group elements that can then be treated as a single object.
- **8.5.5.3.15 Area fill capability.** The application should allow users to fill enclosed areas with selected attributes such as color or patterns.
- **8.5.5.3.16 Computer models.** The application should provide models that allow a user to create a display by specifying parameters. For example, the application might have a model of a pie chart that would allow a user to create a chart by simply specifying the number and size of the segments.

#### 8.5.5.4 Scales, labels, and coding

- **8.5.5.4.1 Standard conventions.** Scales shall conform to the following conventions:
  - a. Values shall increase with distance from an origin.
  - b. Independent variables shall be plotted along the horizontal axis.
  - c. Dependent variables shall be plotted along the vertical axis.
- **8.5.5.4.2 Consistent use of symbols.** Symbols, if used, shall be assigned unique meanings and used consistently throughout an application and related applications (see also paragraph 8.5.4.8.2).
- **8.5.5.4.3 Color and pattern coding.** If colors or patterns are used to fill enclosed areas, they should conform to the following rules:
  - a. Color coding should be redundant with another form of coding.
  - b. If the graphic is not likely to be printed, color should be used rather than patterning.
  - c. If the graphic is likely to be printed, patterning should be used rather than color.

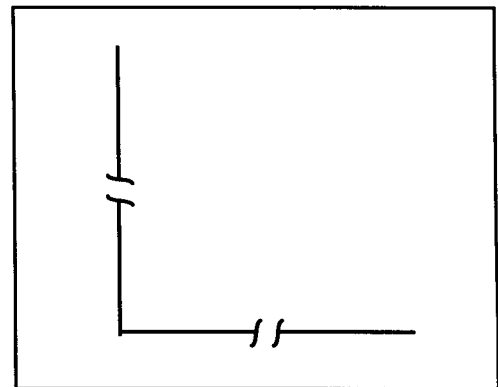
- **8.5.5.4.4 Patterns.** If patterns are used, they should be simple hatching and shading, not complex patterns that produce visual illusions of vibration or motion. Exhibit 8.5.5.4.4 illustrates acceptable and unacceptable patterns.

**Exhibit 8.5.5.4.4** Examples of acceptable and unacceptable patterns



- **8.5.5.4.5 Breaks in axes.** If data are concentrated in a way that makes it desirable to show only a portion of an axis of a graph, the axis shall include the origin and be drawn with a break in it as illustrated in exhibit 8.5.5.4.5.

**Exhibit 8.5.5.4.5** Example of axes with breaks



- **8.5.5.4.6 Duplicate axes.** If necessary to make a graph more readable, one or both of the horizontal and vertical axes should be repeated at the top or right of the graph, as appropriate.

- **8.5.5.4.7 Consistent formats.** If separate graphs are to be compared, or if different sets of data are to be plotted on the same graph, the formats and scales shall be identical (see also paragraphs 8.5.5.6.2 and 8.5.5.6.3).
- **8.5.5.4.8 Linear scales.** In general, linear scales should be used rather than other types, such as logarithmic.

**Discussion.** Logarithmic scales may be appropriate for comparing rates of change.

- **8.5.5.4.9 Single scale per axis.** An axis should represent only a single scale.
- **8.5.5.4.10 Labeling axes.** Each axis shall have a label that describes the axis and its units of measurement. Each axis shall have tick marks corresponding to major scale divisions, and these marks shall be numbered or labeled.

- **8.5.5.4.11 Scale divisions.** Scales should not have more than 12 major scale divisions, and each major division should not be subdivided into more than 10 parts.
- **8.5.5.4.12 Numeric scales.** Numeric scales shall begin with zero, cover the entire range of the data, and, if applicable, the major divisions shall be labeled with decimal multiples of whole numbers.

**Discussion.** This rule prevents the distortion or misinterpretation of data that can result if the origin is omitted or if the scale does not continuously span the data range. It also helps make valid comparisons of different graphs possible.

- **8.5.5.4.13 Label format.** Labels should use upper and lower case sans serif fonts, and they should be oriented to permit normal left-to-right reading.
- **8.5.5.4.14 Labeling data elements.** Labels, rather than legends or keys, should be used to identify plotted data elements. They should be located adjacent to the elements they identify, and they should be oriented to permit normal left-to-right reading.

**Discussion.** If it is awkward to place the labels adjacent to the elements, they may be connected to the elements by arrows, lines, or other pointing conventions.

- **8.5.5.4.15 Location of legends and keys.** If a graph requires a legend or key, the legend or key shall be located inside the rectangular bounds of the graph unless such a location would interfere with interpretation of the displayed data.

### 8.5.5.5 Grid lines

The addition of grid lines to graphs can be helpful to users.

**Definition. Grid lines** are horizontal lines, vertical lines, or both, extending from the scale divisions of one or both axes of a graph, and intended to aid users in locating and reading data points.

- **8.5.5.5.1 When to use.** Grid lines should be used only when they are necessary to help users achieve a desired level of precision. Users should have the option to easily turn grid lines on or off.
- **8.5.5.5.2 Grid lines vs. data.** Grid lines should be easily distinguishable from data, and they should not obscure data.
- **8.5.5.5.3 User choice.** If grid lines are provided, they should be provided in a way that gives users the option of displaying them or not.

### 8.5.5.6 Lines and curves

- **8.5.5.6.1 Use of lines and curves.** Straight lines between data points or smoothed curves through the points should be used to show relationships between two variables.
- **8.5.5.6.2 Labeling and highlighting multiple lines and curves.** If a graph contains more than one line or curve, each one should have an identifying label. If a legend is used to identify the lines, then, to the extent possible, they should appear in the legend in the same order they appear in the graph. If one curve or line is critical, that one should be highlighted.

**Discussion.** The preferred location for labeling a line or curve is adjacent to it, but, if the spacing of the lines or curves makes this difficult, it is acceptable to use a legend.

- **8.5.5.6.3 Coding lines and curves.** If lines and curves are coded to distinguish among multiple curves on the same graph, the coding shall be used consistently throughout an application and related applications for the same types of data.
- **8.5.5.6.4 Cyclic data.** If cyclic data are displayed, at least one full cycle should be presented.
- **8.5.5.6.5 Projected values.** A distinct line code, for example, dashed or dotted lines, should be used to display values projected beyond the actual data set.

### 8.5.5.7 Areas

- **8.5.5.7.1 Area between curves.** If emphasis is on the area between two curves, that area should be filled with color or a pattern.
- **8.5.5.7.2 Stacked curves.** If cumulative data are represented by stacked curves, the curves should be ordered with the least variable at the bottom and the most variable at the top.
- **8.5.5.7.3 Labeling areas.** Areas in graphs should be labeled within the areas to the extent possible.

### 8.5.5.8 Scatterplots

- **8.5.5.8.1 When to use.** Scatterplots should be used to show how individual points are related and distributed along two dimensions.
- **8.5.5.8.2 Highlighting points.** If a scatterplot contains points of particular importance, those points should be highlighted.

### 8.5.5.9 Pie charts

- **8.5.5.9.1 When to use.** Pie charts should be used to show the proportional distribution of categories with respect to the sum of the categories.
- **8.5.5.9.2 When not to use.** If accurate judgments of magnitudes are required, bar charts should be used rather than pie charts.
- **8.5.5.9.3 Labeling pie charts.** Pie chart segments should be labeled inside the segments, if possible. Segment labels should include a number stating either the percentage of the whole represented by the segment or the absolute number the segment represents (or both). Labels should be oriented for normal left-to-right reading.
- **8.5.5.9.4 Highlighting segments.** Segments requiring emphasis should be highlighted or displaced slightly from the rest of the pie chart.

### 8.5.5.10 Pictures

Pictures are appropriate when a detailed representation of objects is required.

- **8.5.5.10.1 Automated aids.** If users must perform detailed analyses of images, the application should provide automated aids (for example, the capability to zoom in on a portion of the picture).

### 8.5.5.11 Diagrams

Diagrams are appropriate if users require information about spatial relationships among objects, but not the level of detail provided by pictures.

- **8.5.5.11.1 Large diagrams.** If a diagram is too large to view all at once, it should be presented in separate sections, with an overview that indicates the separate sections. Notation should be consistent throughout the diagram. The application should provide an easy means for users to move among the sections.
- **8.5.5.11.2 Highlighting portions of diagrams.** If portions of a diagram require special attention, those portions should be highlighted.
- **8.5.5.11.3 Rotation of diagrams.** If users may need to view a diagram from different perspectives, the application should provide the capability of rotating the diagram. The labels of a rotated diagram should be displayed "right-side up" and be legible from the user's perspective.

### 8.5.5.12 Flowcharts

Flowcharts are appropriate for showing schematic representations of sequential processes and as aids to solving problems if solutions can be reached by answering a series of questions.

- **8.5.5.12.1 Flowchart design.** Flowchart design should follow one of the following principles:

- a. logical or sequential order, or
- b. minimum path length.
- **8.5.5.12.2 Consistency.** Words and phrases used for the same purpose shall be consistent throughout a flowchart, an application, and related applications.
- **8.5.5.12.3 Highlighting.** Paths or portions of a flowchart that deserve particular attention should be highlighted.
- **8.5.5.12.4 Flowcharts as decision aids.** Flowcharts used as decision aids should require only one decision at each step, and should provide users with a logically ordered list of available options at each step.
- **8.5.5.12.5 Flowchart orientation.** If possible, flowcharts should be oriented so that paths conform to the following conventions:
  - a. left-to-right,
  - b. top-to-bottom, or
  - c. clockwise.

## 8.5.6 Display control

### 8.5.6.1 General

- **8.5.6.1.1 User tailoring.** Users should be able to tailor information displays by controlling data selection, coverage, updating, and suppression.
- **8.5.6.1.2 Return to normal display.** If user tailoring of displays is allowed, an easy means should be provided to restore the display to its default displays.

### 8.5.6.2 Display of control options

- **8.5.6.2.1 Control locations and options.** Screen control locations and control options shall be clearly and appropriately indicated.
- **8.5.6.2.2 Default values.** If the system prompts a user for a parameter that has a default value assigned, the default value shall be displayed.
- **8.5.6.2.3 Control information.** When a control for manipulating the display becomes available, information the user needs for its use shall also be displayed.

### 8.5.6.3 Data access

- **8.5.6.3.1 Moving through data.** A consistent and easy means should be provided for moving through a data set, for example, scrolling or paging.

**Definitions.** **Scrolling** is a method used to move through the contents of a window or list in a dialogue box using the scroll bar or scroll arrows. **Paging** is process of scrolling through data one page at a time.

- **8.5.6.3.2 Moving through continuous text.** Scrolling and paging should be provided for moving through continuous text. Panning should not be used.

**Definition.** **Panning** is an orientation of display framing in which a user conceives of the display frame as moving over a fixed array of data. The opposite of scrolling.

- **8.5.6.3.3 Moving through grouped information.** Panning and scrolling should not be used to move through logically grouped information, such as a form.

### 8.5.6.4 Panning and zooming

- **8.5.6.4.1 When to provide scrolling, paging, and panning.** If information to be displayed exceeds the available display area, the system should provide a scrolling, paging, or panning capability (see paragraphs 8.5.6.3.2 and 8.5.6.3.3).
- **8.5.6.4.2 When to provide zooming.** If a user will need to view objects such as pictures, diagrams, or maps in detail, the system should provide a zooming capability.

**Discussion.** When a portion of a display has been expanded by zooming, it is also desirable to display the portion in its original size and as much of its surrounding context as will fit. Alternatively, the original display might be reduced and displayed with the enlarged portion highlighted.

- **8.5.6.4.3 Scale indication.** When a portion of a display has been expanded by zooming, the system should provide a scale indicating the amount of expansion.
- **8.5.6.4.4 Scale integration.** Panning and zooming functions should be integrated with and include scales and other overlaid data, such as scale marks and range vectors.

### 8.5.6.5 Information suppression

- **8.5.6.5.1 Suppression indication.** If the display of information is temporarily suppressed, an indication of this suppression shall be provided on the display.

- **8.5.6.5.2 Indication of changes in suppressed information.** The user should be notified of any significant changes in suppressed information.
- **8.5.6.5.3 Restoration of suppressed information.** The system shall provide a quick and easy means for restoring suppressed information.

### 8.5.6.6 Labeling and marking information

- **8.5.6.6.1 Display identification.** If a system allows users to select and manipulate displays, each display shall have an identifying label and other identifying information to support display control and data access.
- **8.5.6.6.2 Labels.** Labels that identify displays shall be unique, brief, and meaningful, and they shall be located prominently and consistently.
- **8.5.6.6.3 Numbering multipage displays.** If information is divided into separate pages for display, each display shall be labeled with the number of the current page and the total number of pages, for example, **Page 3 of 24**.
- **8.5.6.6.4 Numbering items in multidisplay lists.** If the items in a numbered list do not all fit on one display, the entire set of items shall be numbered continuously; numbering shall not start anew with each display.

## 8.5.7 Display regeneration and updating

### 8.5.7.1 General

- **8.5.7.1.1 Update rate.** If a task requires that a user read changing data, for example, the speed or bearing of an aircraft, individual data items shall be displayed long enough for the user to read them reliably and accurately.
- **8.5.7.1.2 "Real time" data.** To be considered "real time," changing data that are used for indications of gross values or rate of change shall be updated between two and five times a second.
- **8.5.7.1.3 Alphanumeric data.** Alphanumeric data that users are required to read reliably and accurately shall not be updated more often than once a second.

### 8.5.7.2 User control

- **8.5.7.2.1 Display regeneration.** Unless constrained by task, application, or system requirements, users should be able to initiate display regeneration.



- **8.5.7.2.2 User control of rate of update.** Unless constrained by task requirements, users should be able to control the rate of information update.
- **8.5.7.2.3 Automatic updating.** If displayed textual data are changed automatically, changed data should be highlighted temporarily or otherwise marked.

### 8.5.7.3 Freeze frame

- **8.5.7.3.1 "Freezing" changing data.** Applications in which displayed data are changed automatically should allow users to "freeze" the display temporarily.
- **8.5.7.3.2 Labeling a frozen display.** If a display is "frozen," its "frozen" status shall be clearly indicated.
- **8.5.7.3.3 Notification of changes while display is frozen.** Users should be notified of any significant changes that occur while a display is frozen.
- **8.5.7.3.4 Unfreezing a display.** Unless specified otherwise by the user, when a frozen display is released from its frozen state, it shall indicate conditions at the time of release, not the time when it was frozen.

## 8.5.8 Maps and situation displays

This section contains criteria and guidelines for map and situation displays in general. Criteria and guidelines for map windows are given in section 8.3.12.4.

**Definitions.** A **map** is a representation of geographic data; a **situation display** is a means of relating dynamic information to a map.

### 8.5.8.1 General

- **8.5.8.1.1 User expectations.** The design of maps and the symbols used in them should be consistent with users' expectations.
- **8.5.8.1.2 Amount of detail.** The amount of detail displayed should be consistent with users' operational needs; that is, neither too much nor too little detail should be displayed.
- **8.5.8.1.3 Map manipulation tools.** The system should provide users with all appropriate tools for moving easily around a map, including zooming and panning. It should also provide insets, registration, and keys for scale.
- **8.5.8.1.4 Curvature.** If large geographic areas are displayed, the curvature of the earth should be treated consistently in all displays.
- **8.5.8.1.5 Situation displays as overlays.** Situation displays should be provided as overlays to their related maps.

- **8.5.8.1.6 Labeling features.** To the extent possible without cluttering the display, all significant features should be labeled.
- **8.5.8.1.7 Consistent label position.** Map labels should be positioned consistently, for example, consistently beneath a feature or consistently within a feature.
- **8.5.8.1.8 Consistent orientation.** If more than one map will be displayed, all maps should have the same orientation, for example, with north at the top.
- **8.5.8.1.9 Coding areas.** Map areas of special interest should be coded by color or shading. If users must make relative comparisons among areas, shades of a single color should be used rather than different colors. If shades of a color are used, the gradation from light to dark should correspond to the variation represented by the shades.
- **8.5.8.1.10 Automated tools.** If users must perform complex analyses of maps, the system should provide the specific, automated tools they need. For example, the system might provide an automated program that prioritizes all alarms displayed on a map.

#### 8.5.8.2 Static display attributes

- **8.5.8.2.1 Map coverage.** Maps shall cover the areas and display all the essential details users need to perform their tasks. Map displays shall be large enough to permit the simultaneous presentation and visual integration required by users.
- **8.5.8.2.2 Necessary features.** All features necessary to the completion of the task shall be represented.
- **8.5.8.2.3 Label legibility.** Labels shall remain legible at all display resolutions.
- **8.5.8.2.4 Reducing clutter.** Users should be provided a means for reducing clutter without losing essential information.
- **8.5.8.2.5 Association of symbols with map features.** A symbol should be placed accurately with respect to the map feature with which it is associated, or connected to the feature with an arrow, line, or other pointing device so that the association between feature and symbol is clear.
- **8.5.8.2.6 Automatic registration.** The system should provide automatic registration of graphic data with background map information at all display scales.
- **8.5.8.2.7 Symbol identification key.** Users should have a means for identifying unknown symbols and other map information. For example, a user might be able to highlight a symbol and learn its meaning through a context-sensitive help feature.

- **8.5.8.2.8 Color coding symbols.** Color coding of symbols shall conform to the criteria and guidelines in section 8.5.4.5.
- **8.5.8.2.9 Nonoverlapping of symbols.** Map symbols should not overlap, particularly if overlapping would obscure their identity. If overlap is unavoidable, users should have a means of moving background symbols to the foreground or otherwise revealing obscured symbols.
- **8.5.8.2.10 Labeling symbols.** Critical symbols should be labeled automatically. Users should have a means for displaying identifying information about other symbols.
- **8.5.8.2.11 Coordinate readings.** If location information will be needed frequently, users should have the option of a constant display of the cursor coordinates in units of their choosing. They should also be able to specify coordinates for the placement of an overlay.
- **8.5.8.2.12 Determining coordinates.** Users should be able to obtain the exact map coordinates of any symbol or map feature.
- **8.5.8.2.13 Context for displayed map.** If a displayed map is not the entire map, an inset should be provided that shows the entire map with the displayed portion highlighted.
- **8.5.8.2.14 Determining distances.** Users should be provided with an automated means for determining the distance between two points on a map.
- **8.5.8.2.15 Determining bearings.** Users should be provided with a means for easily determining the bearing between two points.

### 8.5.8.3 Dynamic display attributes

- **8.5.8.3.1 Panning.** If it is required by their tasks, users should be able to move (pan) the viewpoint or window over the entire map in any direction. As long as it meets users' needs, panning may be either continuous or discrete.
- **8.5.8.3.2 Location information.** Users should be provided feedback during panning operations. For example, the currently displayed portion might be highlighted on an inset display of the entire map.
- **8.5.8.3.3 Return to start.** If panning is provided, users should have the ability to return to the starting configuration quickly and easily.
- **8.5.8.3.4 Zooming.** Users should be able to zoom a display in and out, that is, they should be able to increase and decrease the portion of the entire map displayed on the screen.

- **8.5.8.3.5 Zooming and legibility.** Zooming in and out shall not interfere with the ability of users to read symbols, labels, and other map features.

**Discussion.** It may be appropriate to vary the amount of detail displayed in accordance with the degree of zooming used.

- **8.5.8.3.6 Discrete vs. continuous zooming.** The method of zooming provided, discrete or continuous, should be acceptable to the users.
- **8.5.8.3.7 Return to default.** If zooming is provided, an easy means to return to the default display should also be provided.
- **8.5.8.3.8 Indication of changing scale.** Displays that change scale during zooming should include an indicator that shows the current scale.
- **8.5.8.3.9 Indication of displayed portion of map.** A map that is capable of being zoomed should include an inset that shows the entire map with the currently displayed portion highlighted.
- **8.5.8.3.10 Selecting information for updating.** If appropriate, users should be able to select categories of information that will be updated automatically on a map display.
- **8.5.8.3.11 Stable reference elements.** If a map is updated automatically, it should contain some elements that remain stable that users can use as reference points.
- **8.5.8.3.12 Identification of updates.** Users should have a means for easily identifying updates and changes to a displayed map. In addition, critical changes should be easily distinguishable from other changes. For example, critical changes might be highlighted and remain highlighted until acknowledged by a user.
- **8.5.8.3.13 Control of frequency of updating.** Users should be able to control the frequency with which a display is updated.
- **8.5.8.3.14 Rate of updating.** The rate at which a display is updated should not exceed the perceptual abilities of its users.
- **8.5.8.3.15 Freezing a dynamic display.** Users should be able to freeze a dynamic display, preventing further updates until the display is unfrozen. Frozen displays should include an indication of their frozen state. Users should be able to choose to resume updating from the time the display was frozen or from the current time.
- **8.5.8.3.16 Control of rate of sequencing.** If appropriate, users should be able to control the rate of display sequencing.

**Definition. Display sequencing** is a means of reducing clutter by displaying a series of partial displays (for example, a map and a series of overlays) or of displaying

data sequentially. It can also be used as a form of animation.

- **8.5.8.3.17 Freezing a sequence.** Users should be able to freeze a sequence, preventing further changes until the sequence is unfrozen. Frozen sequences should include an indication of their frozen state. Users should be able to choose to resume a sequence from the time it was frozen or from the current time.
- **8.5.8.3.18 Direction of sequencing.** If appropriate, users should be able to view sequential displays backwards as well as forwards.
- **8.5.8.3.19 Viewing selected displays.** Users should be able to return quickly to a selected display in a sequence of displays.
- **8.5.8.3.20 Grid overlay.** If appropriate, users should be able to display and remove a grid overlay on a map. If present, a grid should be integrated with the map's coordinate system.
- **8.5.8.3.21 Map legend.** Map displays should have associated legends. If the map is dynamic, the legend should change as the map does so that the information is continuously relevant to the current display. This information should include such data as the map scale, cursor location, and status.

#### 8.5.8.4 Creating and editing map graphics

- **8.5.8.4.1 Standard symbol library.** Users should have available a library of standard symbols and a means of transferring and manipulating them.
- **8.5.8.4.2 Labeling symbols.** Users should have an easy means for labeling symbols.

**Discussion.** It might be desirable to provide an automated feature that would aid the user in labeling symbols and enforce labeling conventions.

- **8.5.8.4.3 Tools for constructing symbols and overlays.** If appropriate, users should be provided tools that would aid them in constructing new symbols and graphic overlays.
- **8.5.8.4.4 Editing displays.** If appropriate, users should be able to add to and delete from displays symbols, labels, and other features without destroying background information.
- **8.5.8.4.5 Expanding displays.** Users should be able to expand an area of a display if necessary for the accurate placement of critical data.
- **8.5.8.4.6 Editing display elements.** Users should be able to perform the following editing operations on elements in map displays:

- a. **Select** elements on the display. Selected elements should be highlighted.
  - b. **Move** selected elements on the display.
  - c. **Remove** and **Restore** selected elements on the display.
  - d. **Name, Store, and Retrieve** graphic displays and elements.
- **8.5.8.4.7 Identifying attributes.** If appropriate, users should be able to identify the currently-selected attributes easily.
  - **8.5.8.4.8 Changing display attributes.** Users should be able to change the attributes of selected display elements.
  - **8.5.8.4.9 Changing display attributes by selection.** Users should be able to change display attributes such as color, symbols, and line types by selecting the attributes from displays rather than by naming the options.
  - **8.5.8.4.10 Print preview.** Users should be able to preview symbols and overlays before printing them.

#### 8.5.8.5 Map display characteristics

- **8.5.8.5.1 Map visibility.** If important for task performance and to the extent possible, other displays, such as dialog boxes and windows, should not obscure a map display.
- **8.5.8.5.2 Map cursor.** The cursor in a map display should be a cross hair design that has a high contrast with the background. The cursor should subtend a visual angle of 20 minutes.
- **8.5.8.5.3 Filters.** Users should be able to reduce the clutter of a map display by "filtering" out such things as overlays, roads, cities, vegetation, and topography. The labels and titles of filters should communicate their function clearly to users.
- **8.5.8.5.4 Text and overlays.** Text on maps should be integrated with overlays so that the overlay does not obscure the text. If the text is offset from the feature to which it refers, it should be connected to the feature with a line or arrow.
- **8.5.8.5.5 Color in overlays.** If color is used in overlays, it shall conform to the criteria and guidelines in paragraphs 8.5.4.5.1, 8.5.4.5.2, 8.5.4.5.4, and 8.5.4.5.5.
- **8.5.8.5.6 Intensity.** The intensity of the map should be controllable to allow the map to be dimmed without losing all the map features.
- **8.5.8.5.7 Map as background.** If an application uses one map intensively, it is recommended that the map be used as the background or base screen, which should be the maximum display size possible to promote readability.

### 8.5.9 Voice displays

Voice displays are appropriate (1) to supplement visual displays when communication flexibility is necessary, (2) when coded signal meanings are numerous or may be forgotten, (3) for presentation of complex directions or instructions, (4) when ambient noise may mask simple tonal signals, (5) in conjunction with tonal signals, and (6) for presentation of continuous information when the rate of change is low.

#### 8.5.9.1 Word selection

- **8.5.9.1.1 Word choice.** The words used in voice displays shall be concise, intelligible, and appropriate to the task and the information presented.
- **8.5.9.1.2 Words to avoid.** To the extent possible, words that have other words that rhyme with them or that sound similar in other ways should be avoided if these other words might be used in the same context and therefore possibly be confused with the original words.
- **8.5.9.1.3 "Formal" words.** "Formal" or "correct" words should be used; slang, jargon, and colloquial words should be avoided.
- **8.5.9.1.4 Alphabetic information.** Alphabetic information should be presented using a phonetic alphabet; that is, words like "alpha," "bravo," and "charlie" should be used rather than the letters "A," "B," and "C."

#### 8.5.9.2 Presentation

- **8.5.9.2.1 "Average talker."** Spoken messages should sound like an "average talker," that is, one having an American English accent without a regional dialect.
- **8.5.9.2.2 Distinctive voices.** If different categories of voice signals are used, a different, distinctive voice should be used for each category. For example, one voice might be used for instructional messages and another for warnings.
- **8.5.9.2.3 Content.** Spoken messages should be brief, informative, and to the point.
- **8.5.9.2.4 Speech quality.** Speech intensity should be appropriate to the expected ambient noise environment (see section 13.5 criteria and guidelines regarding ambient noise levels). Signal to noise ratio should be at least 5:1. Audio signal power should be approximately 300 milliwatts at the listener's ear.
- **8.5.9.2.5 Alerting signals.** Spoken warning signals should be preceded by an alerting signal.
- **8.5.9.2.6 Acknowledging warning signals.** The system should require that users acknowledge spoken warning signals.

## 8.6 User guidance

This section contains criteria and guidelines for user guidance, including status information, system-initiated routine and error messages, and on-line help. Different types of users may have different needs for user guidance.

- a. **Novices** (users who have little experience with computers) may need help with basic concepts and operations. Novices may want to see only necessary information.
- b. **Experts** (experienced computer users) may want to know about limitations, shortcuts, complex operations, and anything else that will allow them to do their work more efficiently.
- c. **Casual users** may be either novices or experts, but they use the system infrequently and may need to be reminded of aspects of the system they have forgotten.

### 8.6.1 On-line help

On-line help can provide: (1) procedural aids, (2) the ability to recover from errors, and (3) advice, without requiring a user to exit from the application. Ideally, on-line help is always available and sensitive to the context within which it is requested.

**Definition. On-line help** is primarily an interactive, context-sensitive source of information that can tell a user what entry to make at the current location in an application, what keystrokes are required, or what steps are required to perform to complete a task. Secondly, on-line help is a form of on-line documentation and reference information.

An on-line help facility may provide any or all of three types of help: advice, active help, and passive help. Advice is an interactive, context-sensitive source of information that indicates what entry to make at the current location in the application, the required keystroke(s), or which steps to take to complete the task.

Active help senses an inappropriate entry and interrupts the task to ask users what they are attempting and if they are sure they want to complete the operation they have just initiated. Depending upon the user response to the question, active help then suggests the correct action.

Passive help simply responds to user requests for information. The information may be in the form of on-line system documentation, such as a user's guide or a list of functions performed by combinations of keypresses.



### 8.6.1.1 General

- **8.6.1.1.1 Applicable criteria and guidelines.** On-line guidance information shall conform to the criteria and guidelines for data display in section 8.5.
- **8.6.1.1.2 Availability of on-line help.** Specific user guidance information should be available on-line for display at any point in a transaction sequence.
- **8.6.1.1.3 On-line guidance.** The system should provide users appropriate on-line data, command indexes, and dictionaries to guide them in the selection and composition of data and command entries. This on-line guidance material should include all applicable definitions, lists of allowable entries, ranges of acceptable values, and reference material describing system capabilities and procedures.
- **8.6.1.1.4 User-centered help.** On-line help should be user-centered, that is, based on the task the user is trying to complete, not on the characteristics of the application.
- **8.6.1.1.5 Consistent and distinguishable formats.** User guidance shall be displayed consistently in a format that is distinguishable from that of other displayed data.
- **8.6.1.1.6 Location of displayed help.** To the extent possible, the display of help should not obscure the object about which help was requested. If the help display is in a window, the window should be movable (see paragraphs 8.3.5.3 and 8.3.5.4) and resizable (see paragraphs 8.3.5.6 and 8.3.5.7).
- **8.6.1.1.7 Highlighting critical information.** Critical information in user guidance shall be highlighted using the same methods used to highlight critical information in other types of data display (see section 8.5.4).
- **8.6.1.1.8 Prompts.** The system should allow a user to request the display of prompts for the entry of data and command parameters. If supplied, these prompts should be displayed in a standard location, for example, just above the command entry area or the message area. Additional guidance should be available if the simple prompt is not adequate.
- **8.6.1.1.9 Experienced users.** If the "normal" user guidance techniques provided might slow experienced users, alternative modes should also be provided that allow the bypassing of these "normal" techniques.
- **8.6.1.1.10 Printing help information.** Users should be able to print displayed help information.
- **8.6.1.1.11 Searching on-line help.** Users shall be able to search through on-line **Help** displays.

- **8.6.1.1.12 User annotations.** Users should be able to annotate existing **Help** messages.
- **8.6.1.1.13 User requests.** Users should be able to request help on selected topics.

### 8.6.1.2 Access and return

- **8.6.1.2.1 Access from and return to application.** Users should be able to (1) access help from within an application, that is, without leaving the application, and (2) return to where they were before requesting help.
- **8.6.1.2.2 Reminder of accessibility.** Users should be reminded constantly of the availability of **Help**. This might be accomplished by the display of the word **Help** in a menu bar or by displaying a push button labeled **Help**.
- **8.6.1.2.3 Notification of unavailability of help.** If **Help** is not always available, users should be informed when it is not available. This might be done by dimming a **Help** label.
- **8.6.1.2.4 Standard action.** Users should be able to obtain on-line help by using a standard action that is always available.
- **8.6.1.2.5 Consistent access.** The procedures for accessing on-line help and, if applicable, for moving from level to level should be consistent throughout an application and related applications.
- **8.6.1.2.6 Easy access.** Users should not be required to memorize lengthy sequences or refer to secondary written procedures to access on-line help.
- **8.6.1.2.7 Help command.** The system shall provide a **Help** command that allows users to obtain on-line guidance information.
- **8.6.1.2.8 Easy alternation between help display and original display.** Users should be able to alternate easily between a help display and the display from which help was requested.
- **8.6.1.2.9 Easy return.** After requesting and receiving help, a user should be provided with an easy means to return to the display from which help was requested. For example, a user should not have to call up a menu and select an option to return from a help display.
- **8.6.1.2.10 Control options.** Any help or guidance display should include any relevant control options. For example, a help window might include an **OK** push button for removing the window.
- **8.6.1.2.11 Single action.** Users shall be able to access and exit **Help** with a single action, for example a single keystroke or a single click of a pointing device.

- **8.6.1.2.12 Marking topics for retrieval.** If the number of topics in an on-line help facility is large, and if it would be useful to users to be able to customize the facility by marking individual topics for retrieval, the facility should provide this capability. That is, users should be able to mark individual topics and then retrieve only the marked topics.
- **8.6.1.2.13 Synonyms.** Synonyms for standard terminology should be recognized by help routines.

### 8.6.1.3 Context sensitivity

- **8.6.1.3.1 Task-oriented help.** The information provided in response to a **Help** request shall be relevant to the task and the current transaction within the task.
- **8.6.1.3.2 Ambiguous context.** If the context in which a request for help is made is ambiguous, the system should initiate a dialog in which the user can specify what data, message, or command requires explanation.
- **8.6.1.3.3 Context information in help display.** If a user's request for help depends upon the context established by previous entries, an indication of that context should be included in the help display.
- **8.6.1.3.4 List valid entries.** If possible, when a user makes an invalid entry, the system should provide a list of valid entries.
- **8.6.1.3.5 Historical context.** If appropriate, users should be able to request a displayed record of past transactions.

### 8.6.1.4 Wording and style

- **8.6.1.4.1 Applicable criteria and guidelines.** The wording and style of on-line help shall conform to the criteria and guidelines in sections 10.2.3 and 10.2.4.
- **8.6.1.4.2 Wording.** The wording of help information should be brief, specific, and task-oriented. If appropriate, it may incorporate special terms and technical jargon that are normally employed in the user's tasks.
- **8.6.1.4.3 Appropriate to user.** Help information shall be appropriate to the experience and training of the system users.

### 8.6.1.5 Content

- **8.6.1.5.1 Scope.** On-line help should include (1) memory aids, (2) basic information likely to be of use only to novices, (3) material selected from written documentation, (4) explanations that go beyond written documentation, (5) information that might seem obvious, but may not be to all users, and (6) step-by-step instructions on how to perform the most common tasks.

- **8.6.1.5.2 Only relevant information.** Help displays should contain only information relevant to the current requirements of the user.
- **8.6.1.5.3 Multilevel help.** The system should all provide multiple levels of help, with successive levels providing increasingly detailed levels of explanation.
- **8.6.1.5.4 Help on Help.** On-line help should include help on how to use the on-line help. This help should include:
  - a. a description of all **Help** displays,
  - b. instructions on how to access **Help** from anywhere in the system, including alternative routes, if any,
  - c. instructions on navigating through **Help**, including scrolling, paging, and moving to related topics, if applicable, and
  - d. a description of the current window, including its function and any tasks the user can perform.
- **8.6.1.5.5 Titles.** Each **Help** display shall have a title that identifies its contents and reflects the location from which it originated.
- **8.6.1.5.6 System information.** On-line help should include a description of system capabilities and procedures.
- **8.6.1.5.7 Application information.** On-line help should include a description of the application, including its capabilities, components, options, and structure.
- **8.6.1.5.8 Available commands.** If an application uses commands, an on-line index and description of all commands should be available.
- **8.6.1.5.9 Command examples.** If appropriate, help displays should include examples of correct input or valid commands. Examples should include realistic commands and parameters, not just formal syntax.
- **8.6.1.5.10 Command format.** If appropriate, help displays should include a description of the format of a specified command and a list of allowable commands.
- **8.6.1.5.11 Function keys.** On-line help should provide multilevel descriptions of the actions assigned to function keys.
- **8.6.1.5.12 Prompts, requests, and definitions.** On-line help should provide multilevel help on any displayed prompts or requests and definitions of all important terms.
- **8.6.1.5.13 Error messages.** On-line help should provide multilevel help on error messages.

- **8.6.1.5.14 Shortcuts.** On-line help should point out shortcuts and infrequently used features to users.
- **8.6.1.5.15 Help index.** An on-line index of help topics should be available to users.
- **8.6.1.5.16 Finding Help topics.** The on-line help facility should allow users to press any alphabetic key and obtain a list of the help topics beginning with that letter. Users should then be able to select a topic from the list and obtain the help information for that topic.

## 8.7 Data communication

This section is concerned with communication among users within a single computer system and among users on different interconnected systems. While data communication includes the transmission of all sorts of data among users, for example, text files and graphic files, this section is concerned primarily with the exchange of formatted messages. Special considerations and restrictions that apply to "sensitive" or classified information are given in section 11. Additional information is available in section 8.6.9.2, Message windows.

### 8.7.1 User control and procedures

- **8.7.1.1 Integration with other system functions.** Data transmission functions shall be integrated with other information handling functions within a system.
- **8.7.1.2 Consistent procedures.** Procedures for preparing, sending, and receiving messages shall be consistent between transactions and other information handling tasks.
- **8.7.1.3 Minimal memory load.** Data transmission procedures shall be designed to minimize memory load on the user and to minimize required user actions.
- **8.7.1.4 Explicit user actions.** Both sending and receiving messages shall be accomplished by explicit user action.
- **8.7.1.5 User control.** Users should be in control of what, when, and where data are transmitted.
- **8.7.1.6 Interruptible by user.** Users should be able to interrupt message preparation, review, or disposition. Resumption should be from the point of interruption.
- **8.7.1.7 Annotations to transmitted data.** Transmitted data shall be annotated with any alarm or alert conditions, priority indicators, and other significant information that exist.

## 8.7.2 Preparing messages

### 8.7.2.1 General

- **8.7.2.1.1 Applicable criteria and guidelines.** The procedures for composing messages shall conform to section 8.3. To the extent possible, the procedures for entering messages should be the same as those for general data entry.
- **8.7.2.1.2 Printing messages.** Users should be able to print copies of transmitted messages.

### 8.7.2.2 User control

- **8.7.2.2.1 Length of messages.** Users should be able to prepare and transmit messages of any length.
- **8.7.2.2.2 What can be transmitted.** Users should be able to specify the data to be transmitted. They should be able to incorporate existing file data (including other messages received or transmitted) into messages (see also paragraph 8.7.4.2.2).
- **8.7.2.2.3 Saving prepared messages.** Users should be able to save draft messages during preparation and after completion.

### 8.7.2.3 Message format

- **8.7.2.3.1 User-designed format.** Unless a need exists for a specific message format, users should be able to compose and transmit messages with a format of their own design, and also to compose and transmit messages as unformatted text.
- **8.7.2.3.2 Application-supplied format.** If messages must conform to a defined format, a preformatted message form shall be available to users (see section 8.4.2).

## 8.7.3 Addressing messages

### 8.7.3.1 User control

- **8.7.3.1.1 User-specified destinations.** Users should be able to specify destinations to which data will be transmitted. Destinations may include individuals, groups of individuals, work stations, terminals, and remote printers.
- **8.7.3.1.2 Editing address fields.** Users should be able to edit the address fields in the header of a message being prepared for transmission.
- **8.7.3.1.3 Listing other users on-line.** The system should provide users the capability of listing the other system users who are currently on-line.

### 8.7.3.2 Message formatting

- **8.7.3.2.1 Message header fields.** A basic set of labeled message header fields should be provided, including **Date**, **To**, **From**, **Copy to**, and **Time**. These fields should be interpretable by all systems to which messages can be sent.
- **8.7.3.2.2 Prompting.** Prompting should be provided to guide the user in specifying the address for a message.

### 8.7.3.3 Directories and distribution lists

- **8.7.3.3.1 On-line directories.** On-line address directories should be provided in which users can search for addresses by specifying a complete or partial name, or other address information. Users should be able to select addresses from a directory for automatic entry in address fields.
- **8.7.3.3.2 Substitute addresses.** Users should be able to define substitute addresses for commonly used addresses and use these substitutes to address messages. For example, a user might define "jane" to stand for the address "jdoe@smtplink.cta.com."
- **8.7.3.3.3 User-defined distribution lists.** Users should be able to create and modify their own lists of addressees. They should be able to include the names of distribution lists as well as the names of individual addressees.

### 8.7.3.4 Validation and error correction

- **8.7.3.4.1 Valid address.** To the extent possible, the system should ensure that an address is valid.

**Examples.** If an address is internal to a system, the system might search an on-line directory to validate the address. If an address is external, the system might ensure that the address contains a valid gateway or that the address format is valid.

- **8.7.3.4.2 Error correction.** The system should prompt users to correct any errors it detects before initiating message transmission.

## 8.7.4 Initiating transmission

### 8.7.4.1 System control

- **8.7.4.1.1 Automatic queuing of outgoing messages.** If a system cannot transmit an outgoing message immediately, it should place

the message in a queue and automatically make repeated attempts to transmit it. The user should not have to make repeated attempts.

- **8.7.4.1.2 Appended information.** When a message is sent, the computer should automatically append the sender's address, and the date and time of message creation and transmission.

#### 8.7.4.2 User control

- **8.7.4.2.1 User initiation of data transmission.** Data transmission should be initiated by an explicit user action, for example, a Send command (see also paragraph 8.7.1.4).
- **8.7.4.2.2 What users can transmit.** Users should be able to transmit both information that is displayed on their screens and information stored in files (see also paragraph 8.7.2.2.2).
- **8.7.4.2.3 User-assignable priority.** If a system is capable of treating messages differently based on priority, users should be able to assign a priority to messages.
- **8.7.4.2.4 User-specified delivery.** In addition to immediate transmission, users should be able to specify other times when a message will be transmitted. This specification might include date, time, or upon the occurrence of a specified event.
- **8.7.4.2.5 Notification of transmission and delivery.** Users should be able to request notification that a message has been transmitted and that it has been opened by the addressee.
- **8.7.4.2.6 Cancellation of undelivered messages.** Users should be able to cancel a message that has not been completed and a message that has not been transmitted.

### 8.7.5 Controlling transmission

#### 8.7.5.1 System control

- **8.7.5.1.1 Transmitted message log.** If required, the system should automatically maintain a record of transmitted messages.

#### 8.7.5.2 User control

- **8.7.5.2.1 User-specified feedback.** Users should be able to specify what feedback will be provided for message transmission, and to request specific feedback for particular messages (see also paragraph 8.7.4.2.5).
- **8.7.5.2.2 Cancellation of messages after initiation.** Users should be able to cancel a transmission after initiation, if the message has not been received.



### 8.7.5.3 Transmission failure

- **8.7.5.3.1 Automatic queuing.** If a transmission attempt fails, the system should automatically queue an outgoing message and make subsequent attempts to transmit the message.
- **8.7.5.3.2 Transmission failure.** If message transmission fails, automatic storage of undelivered messages should be provided, and the sender should be notified. Notification should, if possible, include an explanation of the failure.

## 8.7.6 Receiving messages

### 8.7.6.1 System control

- **8.7.6.1.1 Incoming message queuing.** Incoming messages should be queued automatically by time of receipt, message priority, or user specification, pending subsequent review and disposition by the user.
- **8.7.6.1.2 Incoming message log.** The system should automatically maintain a log of incoming messages.

### 8.7.6.2 User control

- **8.7.6.2.1 User control of incoming messages.** Users should be able to specify data that may be received by specifying receipt priority or other characteristics, and they should be able to choose the device (files, display, printer) that will receive messages.
- **8.7.6.2.2 User control of notification of incoming messages.** Users should be able to specify "filters" based on message source, priority, type, or content, that will control their notification of incoming messages.
- **8.7.6.2.3 Naming and describing incoming messages.** Users should be able to assign their own names and other descriptors to received messages.
- **8.7.6.2.4 Disposing of incoming messages.** Users should be able to discard unwanted messages without saving them.

### 8.7.6.3 User review of messages

- **8.7.6.3.1 User specification of summary order.** Users should be able to specify the order in which message summaries are listed.
- **8.7.6.3.2 User review of summary information.** Users should be able to review summary information (for example, the source, type, and priority) about queued incoming messages.

- **8.7.6.3.3 Nondestructive review.** Unless precluded by security or other considerations, users should be able to review messages in their incoming queues without having to dispose (for example, save, delete, or respond) of them.
- **8.7.6.3.4 Applicable criteria and guidelines.** The way in which incoming messages are displayed shall conform to the criteria and guidelines in section 8.4.4.
- **8.7.6.3.5 Annotating incoming messages.** Users should be able to annotate reviewed messages. Annotations should be displayed and should be distinct from the message itself.
- **8.7.6.3.6 Size indication.** The message summary should include an indication of the size of the message. This indication should also be included at the beginning of a message.

#### 8.7.6.4 Incompatible data format

- **8.7.6.4.1 Data preservation.** The arrival of a message in a format incompatible with that of the system shall not result in the loss of the message or of any ongoing transaction.
- **8.7.6.4.2 Notification of incompatible format.** If the format of a data transmission is incompatible with the system receiving it (for example, incompatible with system decoding or with the available devices), the intended recipient should be notified.

#### 8.7.6.5 Notification of incoming messages

- **8.7.6.5.1 Notification at log on.** Users should be notified at log on of any data transmissions received since their last use of the system.
- **8.7.6.5.2 Noninterfering notification.** Notifying a user of an arriving message shall not interfere with any ongoing transaction.
- **8.7.6.5.3 Priority of incoming messages.** If incoming messages will have different degrees of urgency, the messaging system should provide users the ability to assign a priority to a message, and the priority assignment should be indicated for the incoming message.

#### 8.7.6.6 Replying to a message

- **8.7.6.6.1 Automatic addressing of replies.** If a user replies to a message, the messaging system should provide the appropriate address(s) automatically.

## 8.8 Input devices

This section provides criteria and guidelines for keyboards, function keys, pointing devices, and some alternative input devices.

The advantages and disadvantages of non-keyboard input devices are shown in exhibit 8.8. The characteristics of these devices need to be considered in the selection of the appropriate controls for a given task.

**Exhibit 8.8** Advantages and disadvantages of non-keyboard input devices

Type of controller	Advantages	Disadvantage
Mouse	<p>Relatively fast</p> <p>Has low error rates for large targets</p> <p>Allows user to concentrate attention on VDT screen</p>	<p>Requires additional flat work surface</p> <p>Difficult to use for free-hand graphic input</p> <p>High error rates with small targets</p> <p>Lost time when mouse held backwards or sideways</p> <p>Some training needed</p> <p>Wheel (ball) slipping sometimes a problem</p>
Directional controllers (joystick and trackball)	<p>Can be used comfortably with minimum arm fatigue</p> <p>Does not cover parts of the screen in use</p> <p>Expansion or contraction of cursor movement is possible</p> <p>Ball control is an efficient use of space</p>	<p>Slower than a light pen and other "point-to devices" for simple input and option selection.</p> <p>Must be attached, but not to the display.</p> <p>Unless there is a large joystick, an inadequate control to display ratio will result for positional control.</p> <p>The displacement of the stick controls both the direction and the speed of cursor movement.</p> <p>Trackball and joystick controllers are difficult to use for accurate free-hand graphic input.</p> <p>Difficult to integrate the activate switch with the trackball.</p>

**Exhibit 8.8 (continued)** Advantages and disadvantages of non-keyboard input devices

Type of controller	Advantages	Disadvantage
Light pen	<p>Fast for simple input</p> <p>Good for tracking moving objects</p> <p>Minimal perceptual motor skills needed</p> <p>Efficient for successful multiple selection</p> <p>User does not have to scan to find a cursor somewhere on the screen</p> <p>May be adaptable to bar coding</p>	<p>May not feel natural to user, like a real pen or pencil does</p> <p>Requires some fine motor control</p> <p>May lack precision because of the aperture, distance from the CRT screen surface, and parallax</p> <p>Contact with the computer may be lost unintentionally</p> <p>Frequently required simultaneous button depression may cause slippage and inaccuracy</p> <p>Must be attached to terminal, which may be inconvenient</p> <p>Glare problem if pen tilted to reduce arm fatigue</p> <p>Fatiguing if pen is held perpendicular to work surface</p> <p>If pointed to dark area, may require user to flash the screen to find pen</p> <p>One-to-one input only (zero order control)</p> <p>May be cumbersome to use with alternate, incompatible entry methods, like the keyboard</p> <p>Tends to be used for purposes other than originally intended, such as for key depression</p> <p>Tends to be fragile</p> <p>Hand may obstruct a portion of screen when in use</p> <p>Care must be taken to provide adequate "activate" area around choice point</p> <p>Cannot be used on gas plasma panel</p>
Stylus and grid	<p>Good for graphic entry</p> <p>Can be designed to be used on horizontal surface</p> <p>Multipurpose input device</p> <p>Minimal difficulty going from graphic input if character is built into the system, and the tablet is used for the input</p> <p>Spatial correspondence between displays and control movement</p>	<p>Extra space required on work surface</p> <p>Displacement of visual feedback from motor activity may cause coordination problems</p> <p>Entering handprinted characters to be recognized by the system is very slow (fewer than 40 characters/min) compared with typewriter entry (averaging 200 recognition characters/min)</p>

Exhibit 8.8 (continued) Advantages and disadvantages of non-keyboard input devices

Type of controller	Advantages	Disadvantages
Touch screen	No separate input device needed  Fast	Low resolution  Finger can block view  Fingerprints on screen  Tires arm
Voice activation	Does not require hands  Does not require user to shift gaze  Useful for low light conditions  Allows simultaneous activation of more than one control mode  Could be used in lieu of a translator, allowing natural, conversational version of different languages to control complicated systems	Entry can be slow  Must use specified vocabulary  Some systems must be individualized to specific user  If individual's voice changes (for example, become stressed) system may not respond  May require headset  Speaker-dependent systems require template loading time

### 8.8.1 Keyboards

Keyboards vary greatly in the number and arrangement of keys. Most keyboards include the following:

**Note.** In this section, when the name of a key that appears on a keyboard is used, it is printed in **Univers Bold** type.

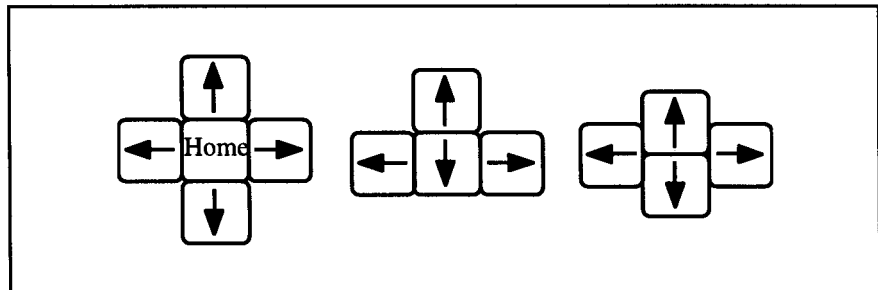
- a. Alphanumeric keys. The letters of the alphabet, numerals, and punctuation symbols (numeric keypads may be separate on portable computers).
- b. Dedicated formatting keys. Keys for text formatting operations such as a **Space bar**, a **Tab** key, and a **Return** or **Enter** key.
- c. Modifier keys. Keys that modify or qualify the effects of other keys for as long as they are held down, for example, **Shift**, **Ctrl**, and **Alt**.
- d. Navigation keys. Keys that move a cursor, for example, arrow keys, **Home**, **End**, **Page Up**, and **Page Down**.
- e. Fixed-function keys. Keys provided for extra or general functions, typically labeled **F1**, **F2**, and so on.

- f. Special purpose keys. Keys that have a special function, such as **Help**, **Delete**, and **Backspace**.
- **8.8.1.1 When to use.** If applicable, keyboards shall be provided for the entry of alphabetic, numeric and other special characters into the system. Keyboards shall conform to ANSI/HFS 100-1988, unless otherwise specified or approved by the acquisition program office.
  - **8.8.1.2 Numeric keypads.** If an application requires substantial and repetitive input of numeric data, the keyboard shall include a numeric keypad.
  - **8.8.1.3 VDT keyboard layout and features.** VDT keyboard layout and features (such as key shape, spacing, force, and height) shall conform to ANSI/HFS 100-1988.
  - **8.8.1.4 Standard keyboards.** If feasible, standard keyboards should be used. Nonstandard keyboards should contain only those keys that are used by the keyboard user.

**Discussion.** The presence of nonrelevant keys, such as those that might be used by programmers, adds to keyboard complexity and may induce errors.

- **8.8.1.5 Cursor movement keys.** Cursor movement keys shall be arranged in a spatial configuration reflecting the direction of actual cursor movement. Exhibit 8.8.1.5 shows the arrangement of cursor movement keys.

**Exhibit 8.8.1.5** Cursor movement keys



- **8.8.1.6 Changing data.** Users shall be provided a means to change previous entries by delete, backspace, and insert actions.
- **8.8.1.7 Keyboard equivalents to function keys.** If an application assigns operations to function keys, the operations that can be performed with a function key should also be performable with alphanumeric keys.
- **8.8.1.8 Keyboard equivalents to pointing device operations.** If an application provides both a keyboard and a pointing device, the operations that can be performed with the pointing device should also be performable with the keyboard (see also paragraph 8.8.5.1).

## 8.8.2 Fixed-function keys

- **8.8.2.1 Standardization.** Fixed-function keys should be standardized throughout the system.
- **8.8.2.2 Availability.** Fixed-function keys should be selected to control functions that are continuously available; that is the lock out of fixed-function keys should be minimized. Mechanical overlays should not be used to lock out function keys.
- **8.8.2.3 Nonactive keys.** If a keyboard is dedicated for use with only a specific application, nonactive fixed-function keys should be replaced by blank keys on the keyboard.
- **8.8.2.4 Grouping.** Fixed-function keys shall be grouped logically and shall be placed in distinctive locations.

## 8.8.3 Pointing devices

This section contains criteria and guidelines for pointing devices in general, the shape of the pointer itself, and buttons on pointing devices.

**Definitions.** A **pointing device** is a non-keyboard device that allows a user to navigate rapidly around the screen and to specify and select objects for manipulation and action. Examples include a mouse, trackball, stylus and grid, and light pen. A **pointer** is a symbol displayed on the screen that is controlled by a pointing device. Its shape may change depending on the function that is invoked at a particular moment or its location on the screen.

### 8.8.3.1 General

- **8.8.3.1.1 Functionality.** If present, a pointing device shall be capable of (1) moving a pointer on the screen, (2) selecting objects on which the pointer is placed, and (3) drop and drag operations.
- **8.8.3.1.2 Single pointer.** A pointing device shall be associated with a single pointer on the screen.
- **8.8.3.1.3 Moving the pointer.** A user shall be able to move the pointer on the screen by moving all or part of the pointing device. The pointer shall move in the same direction that the pointing device moves. A user shall be able to move the pointer anywhere on the screen.
- **8.8.3.1.4 Nondisappearance of pointer.** A pointer shall not move beyond the outer boundaries of the screen, nor shall it disappear from sight.

**Exception.** If there is another screen adjacent to the first, the pointer may move from one screen to the other. This rule does not apply when a cursor is moved quickly and

the screen refresh rate is too slow to show the full path of the cursor.

- **8.8.3.1.5 Control of the pointer.** A pointer should not move on the screen unless a user moves the pointing device. That is, an application should not move a pointer arbitrarily.

**Exceptions.** One exception to this rule is if an application automatically moves the pointer in conjunction with the scroll bar. For example, when the user clicks on the down arrow to scroll through a document, the application may automatically move the pointer so that the pointer will remain on the scroll arrow.

Another case may be when the pointer "jumps" or "snaps-to" a default button because the user has selected that default option.

- **8.8.3.1.6 Pointer stability.** The stability of the pointer shall be within 1.3 mm (0.05 in) in any direction; the preferred stability is within 0.25 mm (0.01 in).
- **8.8.3.1.7 Movement ratio.** The ratio of movement of the pointing device to the movement of the pointer should default to approximately 1:1 and be adjustable by the user.
- **8.8.3.1.8 Type of device.** The pointing device selected for an application should be the one most appropriately meets the application requirements and is most cost-effective. The appropriateness of some specific types of pointing devices for tasks is as follows:
  - a. A **mouse** is a general purpose pointing device suitable for a wide range of applications.
  - b. A **joystick** is appropriate for tasks requiring precise adjustments and continuous control.
  - c. A **trackball** is appropriate for generating precise X and Y output values and cumulative travel in any direction.
  - d. A **light pen** is appropriate for noncritical, imprecise functions, especially if the primary task is item selection.
  - e. A **stylus and grid** is appropriate for graphic entry.

**Discussion.** Another factor that may contribute to the appropriateness of a given input device is the expectations, experiences, or preferences of the intended user population. If a given user population has a wealth of experience, familiarity, or acquired skill with a particular type of device, careful consideration needs to be given to replicate the features, functionality, performance, and "feel" to which they are accustomed.



### 8.8.3.2 Mouse

- **8.8.3.2.1 Use.** A mouse (also known as a free-moving X-Y controller) should be used for zero order control only (for example, the generation of X and Y outputs by the controller results in proportional displacement of the pointer).

**Discussion.** This type of pointing device may be used on any flat surface to generate X and Y coordinate values that control the position of the pointer on the associated display. It may be used for data pick off or for entry of coordinate values.

- **8.8.3.2.2 Dynamic characteristics.** The design of the mouse and the placement of the maneuvering surface shall allow the user to consistently orient the mouse within 10° of the correct orientation without visual reference to the mouse.

**Discussion.** If the user grasps the mouse in what seems to be the correct orientation and moves it rectilinearly along what is assumed to be straight up the Y-axis, then the direction of movement of the cursor on the CRT is to be between 350° and 10°.

- **8.8.3.2.3 Easily moved.** The mouse shall be easy to move in any direction without a change of hand grasp.
- **8.8.3.2.4 Lateral range.** A complete lateral movement of the mouse from side to side within the maneuvering area (such as a mouse pad) shall move the pointer from side to side on the display regardless of the scale setting or offset unless expanded movement is selected for an automatic sequencing mode of operation. Users shall be able to specify or modify the lateral movement ratio.
- **8.8.3.2.5 Dimensions and shape.** The mouse shall have no sharp edges but shall be shaped roughly as a rectangular solid, with limiting dimensions as shown in exhibit 8.8.3.2.5.

**Exhibit 8.8.3.2.5** Dimensions of a mouse

<u>Dimension</u>	<u>Minimum mm (in)</u>	<u>Maximum mm (in)</u>
Width (spanned by thumb to finger grasp)	40 (1.6)	70 (2.8)
Length	70 (2.8)	120 (4.7)
Thickness	25 (1.0)	40 (1.6)

### 8.8.3.3 Joystick and trackball

Joysticks and trackballs are appropriate to use if precise input functions are required. They are most useful when used to

control direct pointing, rather than discrete controls such as cursor control keys.

- **8.8.3.3.1 Use and conformity.** A joystick and trackball shall conform to sections 7.4.4.17 through 7.4.4.22.
- **8.8.3.3.2 Activation and deactivation.** A discrete mechanism shall be provided to allow the user to activate and deactivate the joystick or trackball.

#### 8.8.3.4 Light pen

A light pen is appropriate to use if item selection is the primary type of data entry. For example, a light pen may be used when noncritical, imprecise input functions are required. It may also be used as a track-oriented readout device. It can be positioned on the display screen to detect the presence of a computer-generated track by sensing its refresh pattern. The display system will then present a cursor on the designated track. With suitable additional circuitry, a cursor can be made to track the movement of the light pen across the surface, thus allowing it to function as a two-axis controller capable of serving the same purposes as stylus and grid devices (see section 8.8.3.5).

- **8.8.3.4.1 Dynamic characteristics.** If a light pen is used as a two-axis controller, it shall conform to section 8.8.3.4.
- **8.8.3.4.2 Dimensions and mounting.** A light pen shall be between 120 and 180 mm (4.7 and 7.1 in) long with a diameter between 7 and 20 mm (0.3 and 0.8 in). A clip shall be provided to hold the light pen when it is not in use.
- **8.8.3.4.3 Activation.** A light pen shall be equipped with a discrete activating and deactivating mechanism. A push-tip switch, requiring between 0.5 to 1.4 N (2 to 4 oz) of force to activate, is preferred.
- **8.8.3.4.4 Feedback.** Two forms of feedback shall be provided to the user when using a light pen.
  - a. Feedback concerning the position of the light pen, preferably in the form of a displayed cursor or highlighting, that informs the user that the system is recognizing the presence of the light pen. The feedback shall be large enough to be seen under the point of the light pen.
  - b. Feedback that the light pen has been activated (for example, the push-tip switch has been triggered) and the input has been received by the system.

#### 8.8.3.5 Stylus and grid

A stylus and grid is appropriate to use as a multipurpose input device when combined with a program for character recognition. The stylus and grid are also very good for graphic entry although they are much slower than keyboard entry for alphanumeric data.

- **8.8.3.5.1 Refresh rate.** The refresh rate for the cursor shall be sufficiently high to ensure the appearance of a continuous track whenever the stylus is used to generate free-drawn graphics.
- **8.8.3.5.2 Remote grid size.** A remote grid shall approximate the size of the display.
- **8.8.3.5.3 Remote grid placement.** A remote grid shall have an orientation that is consistent with the directional relationships between them and the display without violating any anthropometric criteria and guidelines (see also Section 14 for anthropometric and biomechanical considerations).





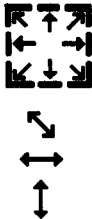


### 8.8.3.6 Pointer shapes

- **8.8.3.6.1 General-purpose pointer shape.** An arrow pointing up and to the left shall be the general-purpose pointer ( $\nwarrow$ ). This and other examples of pointer shapes associated with specific functions are illustrated in exhibit 8.8.3.6.1. If an application provides any of these functions, it shall change the pointer to the associated shape whenever that function is invoked. An application shall redefine the shape of a pointer only when the pointer is inside an application window (including the border).
- **8.8.3.6.2 "Hotspot."** A pointer shall have a "hotspot," that is an active point (although this active point may not be readily apparent to the user). The hotspot shall indicate the precise location where an operation will occur. These points are specified for a variety of pointer shapes in exhibit 8.8.3.6.1.

**Definition.** A **hotspot** is the precise part of a screen pointer that marks the screen position where an operation on a pointing device will have an effect.

- **8.8.3.6.3 Hotspot and pointer shape.** The screen location of a hotspot shall not change if the pointer changes from one shape to another.
- **8.8.3.6.4 Additional pointer shapes.** If an application provides a function for which a pointer shape does not exist in exhibit 8.8.3.6.1, the application may provide a new pointer shape. If this is done, the new shape should (1) be easy to see, (2) obscure as little information as possible on the screen, (3) have a hotspot that is obvious and easy to locate, (4) provide a hint of its purpose, and (5) not be easily confused with other objects on the screen.

Exhibit 8.8.3.6.1 Pointer shapes associated with functions

Shape	Name	Function	Hotspot
	Arrow	<b>Pointing.</b> Used in most window areas for object selection.	The point of the arrow.
	I-beam	<b>Pointing.</b> Used in text areas to position the text cursor and perform actions on text. The I-beam pointer is hidden during the time between any keyboard action and pointer movement (that is, when text entry is occurring at the location of the text cursor).	On the vertical bar of the I-beam about one-third from the top.
	Watch (or hourglass)	<b>Working.</b> Indicates that an operation is being performed in a window area. When the working pointer is displayed, all pointing device and keyboard actions are ignored in the area.	Not applicable
	Caution sign	<b>Caution.</b> Indicates that action is expected in another window area before input can be made in the current area and that the pointer has no effect in the area. When the caution pointer is displayed, all pointing device and keyboard actions are ignored in the area.	Not applicable
	Resize pointer	<b>Resize.</b> Indicates positions for area resize, with the direction of the arrow in the pointer indicating the direction of increasing size. The horizontal and vertical resize pointers indicate resize in either the horizontal or vertical direction. The diagonal resize pointers indicate resize in both the horizontal and vertical directions simultaneously. The resize pointer appears when the pointer is on the frame border.	On the corner or line at the position pointed to by the arrow.
	Move arrows	<b>Moving.</b> Indicates a move operation in progress or a resize operation before the resize direction has been determined. During a resize operation, the four-directional arrow pointer indicates a direction for resizing and changes to the appropriate resize arrow when the pointer is on the frame border.	The intersection of the arrows.
	Sight or cross	<b>Sighting.</b> Used to make fine position selections (for example, to select a location on a map display).	The intersection of the lines.

### 8.8.3.7 Pointing device buttons

One or more buttons are provided on pointing devices to allow the manipulation of objects on the screen.

- **8.8.3.7.1 Button operations.** A user shall be able to perform the following actions with any button on a pointing device:
  - a. Press. Depress a button and hold it down.
  - b. Release. Release a button that has been depressed.
  - c. Click. Press and release a button without moving the pointing device.
  - d. Double click. Press and release a button twice in rapid succession without moving the pointing device.
  - e. Drag. Depress a button and move the device while holding the button down.
  - f. Move. Move the pointing device without pressing any buttons.
- **8.8.3.7.2 Button functions.** Each button on a pointing device shall have a specific function (within the context of the application) that is executed whenever a user presses the button. If the device has only one button, that button shall provide the "select" function; if it has two buttons, the left one shall provide the "select" function and the right button shall provide a "menu" function.

**Definitions.** The **select function** selects or activates objects on the screen or sets the location of the cursor. The **menu function** causes the appearance of a menu appropriate to the location of the pointer.

**Discussion.** If applicable, a system may require that a middle button be used for a particular function (for example, as another means to execute a default action). An application can map a function to the middle button if the function does not contradict or interfere with the function assigned to this button by the system or by another application.

- **8.8.3.7.3 Left-right reversal.** A system shall provide users the ability to reverse the left-right operation of the buttons.

### 8.8.4 Alternative input devices (non-keyboard, non-pointing devices)

Application developers are encouraged to use input devices in unique ways to support efficient user performance within an application. In addition, developers might determine that devices such as voice input or touch panels are appropriate alternatives for user input.

#### 8.8.4.1 General

- **8.8.4.1.1 Consistent interaction.** If an alternate input device is used in an application, the manner in which users interact with

the device (for example, for navigation or selection), should be consistent with their interactions with other input devices.

- **8.8.4.1.2 Type of device.** The alternate input device selected for an application shall be the one that most appropriately meets the application requirements and is most cost-effective. The appropriateness of some specific types of input devices for tasks is as follows:
  - a. A **touch screen or touch panel** is appropriate for data entry and item selection if typing skills are not required.
  - b. An **optical character recognition device** is appropriate for the entry of formatted, printed data.
  - c. A **voice input** device is appropriate if the user's visual and manual performance are constrained.

### 8.8.4.2 Touch panels

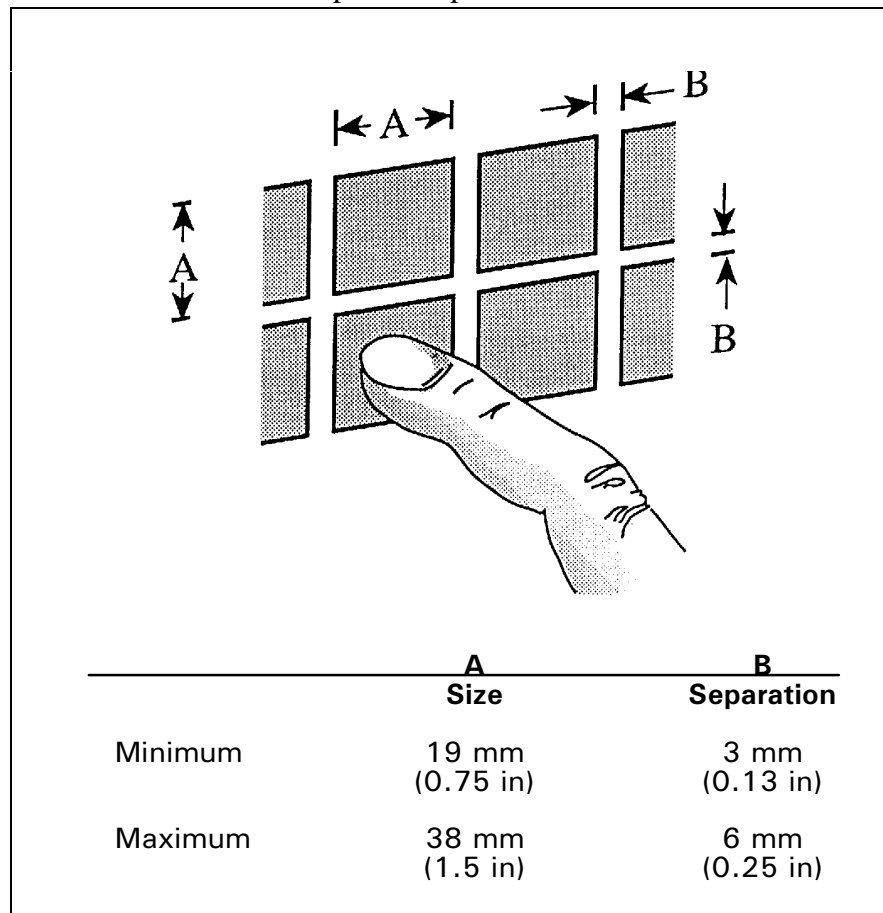
- **8.8.4.2.1 Use.** A touch panel or screen should be used to provide an overlaying control function to a display device (for example, a CRT, an electroluminescent display, or a programmable indicator) if direct visual reference access and optimum direct control access are desired.
- **8.8.4.2.2 When not to use.** A touch panel or screen should not be used when high resolution monitors are needed or if the user will be making large amounts of data input.

**Discussion.** Touch panels and screens have low resolution or diminishes the user's ability to see through a touch membrane. Additionally, users' arms often become tired when they have to use touch panels or screens over an extended period of time due to the lack of arm, hand, or wrist support.

- **8.8.4.2.3 Luminance transmission.** Touch panels shall have sufficient luminance transmission to allow the display to be clearly readable in the intended environment.
- **8.8.4.2.4 Positive indication.** A positive indication of touch-panel activation shall be provided to acknowledge the system response to the control action.
- **8.8.4.2.5 Dimensions and separation.** The dimensions and separation of responsive areas of the touch panel shall not exceed the maximum and minimum values given in exhibit 8.8.4.2.5.

**Note.** The maximum values listed in the exhibit apply to logically grouped touch panel responsive areas. An adverse environment may warrant larger sizes and separations.

- **8.8.4.2.6 Resistance.** The force required to operate force-activated touch panels shall conform to ANSI/HFS 100-1988.

**Exhibit 8.8.4.2.5** Touch panel responsive area dimensions

- **8.8.4.2.7 Display feedback.** Display of user command or action feedback for touch panels shall not exceed 0.25 seconds.

### 8.8.4.3 Voice control

- **8.8.4.3.1 Phonetically distinct vocabulary.** Spoken entries used for transactions should be phonetically distinct from one another. Testing should be performed to determine which sounds and words or phrases can be distinguished reliably.

**Discussion.** Spoken command entries are not to be chosen arbitrarily. Tradeoffs between phonetic distinctiveness and familiarity of terminology need to be evaluated.

- **8.8.4.3.2 Easy error correction.** Feedback and simple error correction procedures shall be provided for speech input so that if a spoken entry has not been correctly recognized by the computer, the user can easily cancel the entry and try again.
- **8.8.4.3.3 Alternative entries.** Alternative input devices shall be available so that if the system cannot recognize a voice entry

after repeated attempts, another type of input entry can be substituted.

### 8.8.5 Interchangeability among input devices

The interchangeability among input devices by the user can be useful during specific operations. Users may want to perform some actions using a keyboard and others actions using a pointing device. The ability to choose which input device must be optional to the user and not a requirement by the system.

- **8.8.5.1 Redundant control.** If more than one input device is present, a user should be able to control computer interaction with all of them. For example, a keyboard should be capable of executing navigation and selection operations when used in conjunction with a mouse, light pen, or other input devices (see also 8.8.1.8).

**Discussion.** Full interchangeability is not required. It is assumed that a user will select the input device that is most appropriate for the task being performed. For example, a user may rely on direct manipulation, using a pointing device such as a mouse or trackball, as the primary means of interaction for object selection and manipulation. Similarly, a user may use a keyboard primarily for text entry and for object selection being performed in conjunction with or interspersed with text entry.

### 8.9 Accommodating people with disabilities

The "Americans with Disabilities Act of 1990" (Public Law 101-336) prohibits employment discrimination against qualified individuals with disabilities. If a person's disability creates a barrier to employment, the Act requires that the employer consider whether reasonable accommodations could remove the barrier. The intent of the Act is to permit people with disabilities to compete with people without disabilities on the basis of the same performance standards and requirements once such accommodations have been made.

In general, there is no clear division between people with and without disabilities; rather any single ability tends to be distributed as a continuous function, and any individual may be at the high end of the distribution for some abilities and at the low end for others. Still, there is a large and growing number of people with disabilities or functional limitations. One estimate is that between ten and twenty percent of the United States population have significant disabilities. Indeed, almost everyone will experience functional limitations sufficient to make the operation of equipment or systems difficult if not impossible at some time during their lives.

Disabilities are not necessarily inborn or permanent. They may be temporary consequences of injury or illness, and they may be determined by the immediate environment. For example, a person might not be able to see a control or display because of darkness or might not be able to hear an auditory signal because of noise.



**Definitions.** An **impairment** is a loss or abnormality of physiological or anatomical structure or function. A **disability** is a physical or mental impairment that substantially limits one or more of a person's major life activities. A **person with a disability** is a person who has a disability, has a record of a disability, or is regarded as having a disability. A **qualified person with a disability** is a person who meets legitimate skill, experience, education, or other requirements of an employment position that he or she holds or seeks, and who can perform the essential functions of the position with a reasonable accommodation, if necessary. A **reasonable accommodation** is any modification or adjustment to a job or the work environment that will enable a qualified person with a disability to participate in the application process and to perform essential job functions. It may include: (1) making existing facilities readily accessible to and usable by people with disabilities, (2) restructuring jobs, (3) providing part-time or modified work schedules, (4) acquiring or modifying equipment or devices, (5) adjusting or modifying examinations, training materials, or policies, (6) providing qualified readers or interpreters, and (7) other similar accommodations.

In many cases, there are simple and low-cost (or even no cost) adaptations to equipment and systems that can significantly increase their accessibility and usefulness to people with disabilities. The most economical approach appears to be to design equipment and systems so that they are accessible to as many people as possible or practical. This is most easily accomplished when accessibility is considered during the design of the equipment or system.

A word of caution is in order: initial attempts at accessibility are sometimes made piecemeal; that is, features are made accessible rather than the equipment or system as a whole. For example, one feature might be made accessible to people with visual disabilities, and another feature to people with hearing disabilities, with the result that the equipment or system is not fully usable by either group. In most cases, it is possible, with careful design, to create equipment or systems that are simultaneously accessible to people with different types of disability. In any case, care must be taken to ensure that all the functions of the equipment or system are accessible to the desired populations of users.

Anything that is done to make equipment or systems more accessible is likely to be of benefit to all users, not just those with disabilities. For example, dips in curbs at pedestrian crossings of roadways were originally intended to accommodate people in wheelchairs, but they have also been of benefit to people with baby carriages, strollers, shopping carts, bicyclists, and pedestrians in general.

## 8.9.1 General

- **8.9.1.1 Equal access.** People with disabilities should have access to the same electronic office equipment, data bases, operating systems, and application programs as people without disabilities.

**Discussion.** With respect to **input**, access might be achieved by providing:

- a. alternative input mechanisms, including alternatives to simultaneous keystrokes, automatic repeat on depression of a key for a period of time, and alternatives to a mouse,
- b. the capability of connecting an alternative input device, or
- c. nonvisual keyboard orientation aids.

With respect to **output**, access might be achieved by providing:

- a. auditory alternatives to visual outputs,
- b. visual alternatives to auditory outputs, or
- c. access to the screen memory for the purpose of enlarging the display, converting text to speech, or converting graphics into an auditory representation.

- **8.9.1.2 Equal computing capability.** People with disabilities should have essentially the same computing capability as people without disabilities in the same position and office.
- **8.9.1.3 Support in manipulating data.** People with disabilities should be supported in manipulating data so as to attain end results equivalent to people without disabilities.

## 8.9.2 Accommodating people with moderate physical disabilities

Most of the difficulty experienced by people with physical disabilities in using computer systems stem from using input devices, such as a keyboard or a mouse, and from handling storage media, such as computer diskettes.

- **8.9.2.1 Multiple, simultaneous activations.** If a system requires multiple, simultaneous activations, such as the simultaneous depression of two or more keys on a keyboard, the system should provide an optional, alternative mode of operation.

**Example.** One possible alternative mode of operation would accept sequential rather than simultaneous activations.

- **8.9.2.2 Timed responses.** If a system requires a response in less than 5 sec or the release of a key in less than 1.5 sec, the system should provide either a means by which a user can adjust the time interval or an alternate mode that does not have the time requirements (see also paragraphs 7.6.3.5 and 8.9.2.8).
- **8.9.2.3 "Pointing" from the keyboard.** A system that uses a pointing device, such as a mouse, should include a means for carrying out all of the pointing functions from the keyboard.
- **8.9.2.4 Cursor control devices.** The select key on a cursor control device should have toggle capabilities, either as a standard feature or as a user-configured option, that allow a user to operate the device in a "button down" mode.

**Discussion.** People with disabilities are likely to have difficulty simultaneously holding a select button down and moving the device, for example, in "dragging" an object in a graphical display.

- **8.9.2.5 Minimal number of "small" targets.** The number of small targets should be minimized, especially if they are likely to be the objects of drag operations.

**Discussion.** The difficulty of moving a pointer onto an object and of moving an object increases as the size of the object decreases, and the difficulty is greater for people with disabilities than for people without disabilities. If small objects cannot be avoided, a zooming capability might be provided (see also paragraph 8.9.4.1).

- **8.9.2.6 Handling insertable and removable parts.** System components intended to be insertable and removable, such as computer diskettes, should require minimal reach and minimal manual dexterity.
- **8.9.2.7 Controls and latches.** Controls and latches that are used regularly in the operation of a system should be accessible and operable with minimal reach and minimal manual dexterity.
- **8.9.2.8 Avoiding inadvertent operation.** A computer or computer system intended to be operable by people with moderate motor disabilities should provide either a means for delaying the acceptance of a keystroke for a preset, adjustable amount of time (see also paragraphs 7.6.3.5 and 8.9.2.2) or a keyguard or means for mounting a keyguard.

**Definition.** A **keyguard** is a keyboard cover with holes over keys the user is allowed to operate.

### **8.9.3 Accommodating people with severe physical disabilities**

For people with severe physical disabilities, modifications to standard input devices may not be sufficient to allow them to use a computer. In these cases, a means for connecting an alternative keyboard, mouse, or other input device may be required.

- **8.9.3.1 Connection point for alternative input device.** A computer or computer system should provide a point at which an alternative input device can be connected. The computer should treat input from the alternative device the same as input from standard input devices.

**Discussion.** One possible solution would be to provide a system command that would cause input from a standard serial, parallel, or other system port to be treated as if it had come from the computer's standard input devices.

## 8.9.4 Accommodating people with visual disabilities

Most of the difficulty people with visual disabilities have with computer systems arises in connection with output displays. Some difficulty also arises from input devices that require eye-hand coordination.

- **8.9.4.1 Enlarging a display.** People with visual disabilities should be provided a means for enlarging a display (see also paragraph 8.9.2.5).

**Discussion.** This might be accomplished either by providing a means for attaching a larger display or by providing a means for enlarging all or part of the displayed image.

- **8.9.4.2 Selecting display colors.** If it is necessary to distinguish the color of graphics or text to understand displayed information, users should be able to select the colors used. However, see paragraph 8.2.4.1.17 on limiting user selection of colors.
- **8.9.4.3 Readability of lettering on keys and controls.** The lettering on keys and controls required for the operation of a computer or computer system should be large enough to be read easily and should have a distinct contrast with its background.

**Discussion.** This might be accomplished by providing keycaps that can be removed easily and replaced with special keycaps for the visually impaired.

## 8.9.5 Accommodating people who are blind

People who are blind usually have most of their difficulty with output displays. Some input devices also cause difficulty, for example, touch screens.

- **8.9.5.1 Connection point for alternative output devices.** Computers and computer systems should provide a point to which an alternative output device can be connected. Visually displayed information, both text and graphics, should be available at that point in a standard format.

**Discussion.** The connection point might be a standard serial or parallel port. Alternative output devices include speech synthesizers and braille display devices.

- **8.9.5.2 Alternatives to input devices.** If a computer or computer system has a standard input system that requires continuous visual feedback for operation, for example, a mouse or touch screen, the computer or system should provide an alternate means or mode for achieving as many of the input functions as possible. The alternative means or mode should be available at all times and should not require continuous visual feedback.

**Discussion.** It may not be possible to provide a reasonable alternative for some functions. For example, inputs such as free-hand sketching cannot be done easily without a device that requires eye-hand coordination.

- **8.9.5.3 Nonvisual indication of state of toggle keys.** A computer or computer system should provide blind users with a nonvisual indication of the state of toggle keys. This indication may be available automatically or upon the user's request.

**Discussion.** Probably the best solution from a blind person's point of view would be the use of switches that give a physical indication of their state, for example, toggle switches or rocker switches.

- **8.9.5.4 Key demarcation.** All keys should have edges that can be discerned by touch. In particular, flat membrane keys without ridges outlining the keys should not be used.
- **8.9.5.5 Identification of "home" keys.** The "home" keys of keyboards and keypads should have a distinct marking that can be discerned by touch.
- **8.9.5.6 Key labels.** Optional or built-in nonvisual labelling of keys should be provided or available.

## 8.9.6 Accommodating people with hearing disabilities

People who have hearing disabilities and people who are deaf usually have little difficulty using computers. Most of the problems they do have can be eliminated by providing redundant visual outputs to tones and other auditory outputs.

### 8.9.6.1 General

- **8.9.6.1.1 Redundant visual output.** All information required for system operation and error detection that is presented in auditory form should also be provided or available redundantly in an appropriate visual form.
- **8.9.6.1.2 Hearing auditory outputs.** Computers and computer systems intended to be accessible to people with hearing disabilities should be designed to maximize the number of people who can hear auditory outputs (see also paragraph 7.6.2.1).

**Discussion.** Auditory information (for example, synthesized speech, beeps, buzzers, tones, and machine

noises) may not be heard well enough to elicit the intended response. Possible solutions include:

- a. provide a volume adjustment,
- b. make auditory output as loud as practical,
- c. use sounds that have strong middle- and low-frequency components (500 - 3000 Hz),
- d. provide a headphone jack so that people with hearing disabilities can listen at high volume,
- e. provide a separate volume control for headphone jacks,
- f. place a sound source on the front of a device and away from sources of loud noise,
- g. include in the equipment a built-in inductive coil to facilitate the direct use of the telecoil in hearing aids,
- h. reduce the amount of nonmeaningful sound produced by the equipment, and
- i. present auditory information continuously or repetitively until the user responds to it.

### 8.9.6.2 Auditory screen representation

- **8.9.6.2.1 Granularity.** If a graphical interface is given an auditory representation, the auditory representation should be based on interface objects, not pixels.
- **8.9.6.2.2 Navigation.** Navigation in an auditory representation should move the user's position among different auditory interface objects.

**Discussion.** Standard mouse movement is in terms of pixels, which have little or no meaning in an auditory representation.

- **8.9.6.2.3 Hear and feel consistency.** The same type of object, such as a push button, shall have the same auditory representation and shall operate in the same way throughout an auditory interface.
- **8.9.6.2.4 Dual representation.** All interactions that a person without visual disabilities would see between the mouse cursor and objects on the screen should have auditory counterparts. These sounds may be simple or complex tones or patterns of tones, or speech.

- **8.9.6.2.5 Objects represented.** An interface given both visual and auditory representation should incorporate into the auditory representation at least the following objects if they appear in the corresponding visual interface:
  - a. menus,
  - b. windows,
  - c. dialogs,
  - d. buttons, and
  - e. scroll bars.
- **8.9.6.2.6 Nonoverlapping objects.** An interface that is given both visual and auditory representation should not have objects that completely obscure other objects, for example, a window that completely overlaps another window.
- **8.9.6.2.7 Eliciting an object's name.** A user should be able to elicit the name of the object currently being pointed at.

**Example.** Pressing one of the buttons of a mouse might result in a synthesized speech announcement of the name of the object.
- **8.9.6.2.8 Size and location of objects.** In general, users should not be able to move or change the size of objects in auditory representations.

## 8.9.7 Accommodating people who have seizure disorders

- **8.9.7.1 Avoiding flashing-induced seizures.** Computers and computer systems should maximize the number of people who can view an output display without experiencing a seizure (see also paragraph 7.6.2.8).

**Discussion.** People who are sensitive to seizures may have seizures induced by flashing screen cursors or by flickering displays. The solution is to ensure that the flash or display refresh rate is as far above or below 15-20 Hz as possible or practical.

## 8.9.8 Accommodating assistive devices

- **8.9.8.1 Electronic documentation.** Manuals and other important documentation intended to be accessible to people with disabilities should be available in electronic as well as printed

form. This would permit presentation of the material on an assistive device such as an enlarged display, a speech synthesizer, or a braille reader. Both text and graphic information should be included (same as paragraph 10.6.1).

- **8.9.8.2 Speech output compatibility.** Computers and computer systems should provide a built-in speech output capability or provide a point to which a speech synthesizer can be connected.
- **8.9.8.3 Special display window.** A windowing environment should provide the capability of opening and maintaining a special window that can remain fully visible. Once displayed, the special window would be available continuously for use by special input routines.
- **8.9.8.4 Connection point for switches.** Computers and computing systems should provide a point at which at least two momentary contact single-pole single-throw input switches can be connected.

**Discussion.** Some alternative input devices require the connection of special switches or interfaces. Examples are "sip and puff" switches and eye blink switches. Unused pins on existing connectors could serve as these connection points. It would be desirable to be able to connect analog transducers as well as binary switches.

- **8.9.8.5 Distinguishing macro input from typed input.** Computers and computing systems should be able to distinguish between typed, auto-repeat, and macro-generated "keystrokes" so that, if appropriate, they can be treated differently by the operating systems and application software.

**Discussion.** "Keystrokes" generated by assistive devices or assistive software may be sent faster than the application software can recognize them, in which case, they may be ignored, thus preventing use of the assistive device or software.

- **8.9.8.6 Keyguards.** Keyboards should be designed so that keyguards can be mounted easily.

**Discussion.** It is desirable that the manufacturer of the keyboard also supply a compatible keyguard.



## Section 9 contents

<b>9 Workplace design</b> .....	<b>9-1</b>
<b>9.1 General</b> .....	<b>9-1</b>
▪ 9.1.1 Design for human activities .....	9-1
▪ 9.1.2 Physical accomodtion .....	9-1
▪ 9.1.3 Work space to permit access .....	9-2
□ 9.1.4 Maintenance independence .....	9-2
□ 9.1.5 Maintenance and operations interference .....	9-2
▪ 9.1.6 Illumination compatibility with operations .....	9-2
▪ 9.1.7 Task and general illumination of work space .....	9-2
▪ 9.1.8 Special information and communications interfaces .....	9-3
▪ 9.1.9 Colors .....	9-3
<b>9.2 Workplace layout</b> .....	<b>9-3</b>
<b>9.2.1 Equipment layout</b> .....	<b>9-3</b>
▪ 9.2.1.1 Traffic and congestion .....	9-3
□ 9.2.1.2 Equipment grouping .....	9-3
▪ 9.2.1.3 Equipment arrangements for groups of workers .....	9-3
□ 9.2.1.4 Layout for safety .....	9-4
▪ 9.2.1.5 Access interference .....	9-4
▪ 9.2.1.6 No stacking .....	9-4
▪ 9.2.1.7 Criticality for maintenance .....	9-4
▪ 9.2.1.8 Frequency of maintenance .....	9-4
▪ 9.2.1.9 Visual access .....	9-4
▪ 9.2.1.10 Clear visual inspection .....	9-4
□ 9.2.1.11 Front removal .....	9-4
▪ 9.2.1.12 Floor space for work and passage .....	9-4
▪ 9.2.1.13 Depth of the work area .....	9-5
▪ 9.2.1.14 Lateral work space .....	9-5
▪ 9.2.1.15 Rear access space .....	9-5
<b>9.2.2 Work space features designed into equipment</b> .....	<b>9-6</b>
<b>9.2.2.1 Designed-in access</b> .....	<b>9-6</b>
▪ 9.2.2.1.1 Access space for effective maintenance .....	9-6
□ 9.2.2.1.2 Panels and access doors .....	9-6

	<b>Exhibit 9.2.2.1.2</b> Access space through integral design .....	9-6
	□ <b>9.2.2.1.3</b> Component locations for access .....	9-6
<b>9.2.2.2</b>	<b>Foot space</b> .....	<b>9-7</b>
	■ <b>9.2.2.2.1</b> Kickspace .....	9-7
<b>9.2.2.3</b>	<b>Work surfaces</b> .....	<b>9-7</b>
	■ <b>9.2.2.3.1</b> Work surfaces for standing positions .....	9-7
	■ <b>9.2.2.3.2</b> Work surfaces for seated positions .....	9-7
	■ <b>9.2.2.3.3</b> Writing surfaces .....	9-7
	■ <b>9.2.2.3.4</b> Task sizing of work surfaces .....	9-7
<b>9.2.2.4</b>	<b>Storage</b> .....	<b>9-7</b>
	■ <b>9.2.2.4.1</b> Storage space .....	9-7
<b>9.2.3</b>	<b>Workstations for maintenance repair</b> .....	<b>9-7</b>
	■ <b>9.2.3.1</b> Sizing .....	9-8
	■ <b>9.2.3.2</b> Special equipment .....	9-8
<b>9.3</b>	<b>Design of passageways</b> .....	<b>9-8</b>
<b>9.3.1</b>	<b>Walkways and traffic areas</b> .....	<b>9-8</b>
	■ <b>9.3.1.1</b> Corridors .....	9-8
	<b>Exhibit 9.3.1.1</b> Walkway and passageway dimensions .....	9-9
	□ <b>9.3.1.2</b> Added clearance .....	9-8
	■ <b>9.3.1.3</b> Floors .....	9-8
	□ <b>9.3.1.4</b> Traffic areas .....	9-9
<b>9.3.2</b>	<b>Catwalks, tunnels, and crawl spaces</b> .....	<b>9-9</b>
	■ <b>9.3.2.1</b> Approval for use .....	9-10
	■ <b>9.3.2.2</b> Access and rescue in special passageways .....	9-10
	■ <b>9.3.2.3</b> Guardrails and nonskid surfaces .....	9-10
	■ <b>9.3.2.4</b> Catwalk and ladder orientation .....	9-10
	■ <b>9.3.2.5</b> Minimum catwalk width .....	9-10
	■ <b>9.3.2.6</b> Enclosed space ventilation .....	9-10
	■ <b>9.3.2.7</b> Movement or work without mechanical aid .....	9-10

<b>9.3.3 Platforms, elevators, inclimators</b>	.....	<b>9-10</b>
<b>9.3.3.1 Raised platforms</b>	.....	<b>9-11</b>
▪ 9.3.3.1.1 Raised platform minimum dimensions	.....	9-11
▪ 9.3.3.1.2 Hands free work area	.....	9-11
▪ 9.3.3.1.3 Permissible gaps with equipment	.....	9-11
▪ 9.3.3.1.4 Platform strength	.....	9-11
▪ 9.3.3.1.5 Test equipment support	.....	9-11
<b>9.3.3.2 Portable platforms</b>	.....	<b>9-11</b>
□ 9.3.3.2.1 Portable platforms	.....	9-11
▪ 9.3.3.2.2 Platform wheels and brakes	.....	9-11
<b>9.3.3.3 Floor surfaces for walkways and platforms</b>	.....	<b>9-11</b>
▪ 9.3.3.3.1 Surfaces for platforms and work areas	.....	9-11
<b>9.3.3.4 Guardrails, toeholds, screens, and handholds</b>	.....	<b>9-11</b>
▪ 9.3.3.4.1 Guardrails	.....	9-11
▪ 9.3.3.4.2 Guardrail dimensions	.....	9-12
▪ 9.3.3.4.3 Toe board or guard screen	.....	9-12
▪ 9.3.3.4.4 Handholds	.....	9-12
▪ 9.3.3.4.5 Handholds, guardrails for adverse conditions or motion	.....	9-12
<b>9.3.3.5 Elevators and hydraulically operated platforms</b>	.....	<b>9-12</b>
▪ 9.3.3.5.1 Elevators, inclimators, and hydraulic work platforms	.....	9-12
▪ 9.3.3.5.2 Designed-in safety features	.....	9-13
<b>9.3.4 Entrances and exits</b>	.....	<b>9-13</b>
<b>9.3.4.1 General</b>	.....	<b>9-13</b>
□ 9.3.4.1.1 Routine	.....	9-13
▪ 9.3.4.1.2 Population accommodation	.....	9-13

<b>9.3.4.2 Doorways and hinged doors</b>	.....	<b>9-13</b>
▪ 9.3.4.2.1 Door dimensions	.....	9-13
<b>Exhibit 9.3.4.2.1</b> Door dimensions	.....	9-14
▪ 9.3.4.2.2 Door width expanded for carrying equipment	.....	9-14
▪ 9.3.4.2.3 Door clearances	.....	9-14
▪ 9.3.4.2.4 Door opening direction	.....	9-14
▪ 9.3.4.2.5 Doors for two people	.....	9-14
□ 9.3.4.2.6 Door size or quantities	.....	9-14
<b>9.3.4.3 Alternative door guidelines</b>	.....	<b>9-15</b>
□ 9.3.4.3.1 Sliding and folding doors	.....	9-15
□ 9.3.4.3.2 Swinging doors	.....	9-15
□ 9.3.4.3.3 Revolving doors	.....	9-15
□ 9.3.4.3.4 Floor to ceiling glass doors or windows	.....	9-15
<b>9.3.4.4 Emergency doors and exits</b>	.....	<b>9-15</b>
□ 9.3.4.4.1 Space for exit	.....	9-15
▪ 9.3.4.4.2 Emergency door and exit design and construction	.....	9-15
▪ 9.3.4.4.3 Changes in elevation in a "way of exit"	.....	9-16
▪ 9.3.4.4.4 Exit signs	.....	9-16
<b>9.3.4.5 Hatches</b>	.....	<b>9-17</b>
▪ 9.3.4.5.1 Use of hatches for maintenance purposes	.....	9-17
▪ 9.3.4.5.2 Flush with surfaces	.....	9-17
▪ 9.3.4.5.3 Hatch opening motion	.....	9-17
▪ 9.3.4.5.4 Hatch opening and closing forces	.....	9-17
▪ 9.3.4.5.5 Clearance dimensions for hatches	.....	9-17
▪ 9.3.4.5.6 Limiting dimensions for hatches	.....	9-17
▪ 9.3.4.5.7 Rescue requirements	.....	9-17
▪ 9.3.4.5.8 Rectangular hatch minimums	.....	9-17
<b>9.3.4.6 Whole body access</b>	.....	<b>9-18</b>
▪ 9.3.4.6.1 Whole body access	.....	9-18
<b>Exhibit 9.3.4.6.1</b> Whole body access dimensions	.....	9-18
□ 9.3.4.6.2 Emergency escape hatches	.....	9-18
□ 9.3.4.6.3 Floor hatches and open holes	.....	9-19

<b>9.3.5 Ramps, ladders, stairs</b>	.....	<b>9-19</b>
<b>9.3.5.1 Selection and uses for specific applications</b>	.....	<b>9-19</b>
■ 9.3.5.1.1 Selection	.....	9-19
<b>Exhibit 9.3.5.1.1</b> Type of structure in relation to angle of ascent	.....	9-19
■ 9.3.5.1.2 When to use	.....	9-20
□ 9.3.5.1.3 For heavy carrying	.....	9-20
<b>9.3.5.2 Common design requirements</b>	.....	<b>9-20</b>
■ 9.3.5.2.1 Material characteristics	.....	9-20
■ 9.3.5.2.2 Carrying strength of the structure	.....	9-20
■ 9.3.5.2.3 Nonskid floor surfaces	.....	9-21
■ 9.3.5.2.4 Warning labels	.....	9-21
■ 9.3.5.2.5 Handrails	.....	9-21
■ 9.3.5.2.6 Proper illumination	.....	9-21
<b>9.3.5.3 "Working" ramps</b>	.....	<b>9-21</b>
■ 9.3.5.3.1 Dimensions for ramps	.....	9-21
<b>Exhibit 9.3.5.3.1</b> Critical dimensions for ramps	.....	9-22
■ 9.3.5.3.2 Ramps for pushing and pulling equipment on carts	.....	9-21
□ 9.3.5.3.3 Combined vehicular or cart and personnel traffic	.....	9-22
<b>Exhibit 9.3.5.3.3</b> Combined ramp and stairs	.....	9-22
□ 9.3.5.3.4 Handrails for ramps	.....	9-22
□ 9.3.5.3.5 Nonskid materials for ramps	.....	9-22
■ 9.3.5.3.6 Ramp landings	.....	9-23
<b>9.3.5.4 Stairs</b>	.....	<b>9-23</b>
■ 9.3.5.4.1 Dimensions for stairs	.....	9-23
<b>Exhibit 9.3.5.4.1</b> Design requirements for stairs dimensions	.....	9-24
□ 9.3.5.4.2 Landings, stair lengths, riser, and tread dimensions	.....	9-23
□ 9.3.5.4.3 Open tread and protection beneath	.....	9-23
□ 9.3.5.4.4 Stair design for load carrying	.....	9-23

<b>9.3.5.5 Stair ladders</b>	.....	<b>9-25</b>
■ 9.3.5.5.1 Dimensions for stair ladders	.....	9-25
<b>Exhibit 9.3.5.5.1</b> Design requirements for stair ladder dimensions	.....	9-25
□ 9.3.5.5.2 Two way traffic with stair ladders	.....	9-26
□ 9.3.5.5.3 Open treads and protection	.....	9-26
<b>9.3.5.6 Fixed ladders</b>	.....	<b>9-26</b>
■ 9.3.5.6.1 Dimensions for fixed ladders	.....	9-26
<b>Exhibit 9.3.5.6.1</b> Design requirements for fixed ladders	.....	9-27
□ 9.3.5.6.2 Guarded landings, entrances, and cages	.....	9-26
<b>Exhibit 9.3.5.6.2</b> Design requirements for fixed ladder cage dimensions	.....	9-28
□ 9.3.5.6.3 Rungs versus level steps	.....	9-28
□ 9.3.5.6.4 Tread and tread rise	.....	9-28
<b>9.3.5.7 Portable ladders</b>	.....	<b>9-28</b>
■ 9.3.5.7.1 Dimensions for portable ladders	.....	9-28
<b>Exhibit 9.3.5.7.1 (a)</b> Design requirements for portable step ladders	.....	9-29
<b>Exhibit 9.3.5.7.1 (b)</b> Design requirements for portable rung ladders	.....	9-30
■ 9.3.5.7.2 Lifting ladders	.....	9-30
□ 9.3.5.7.3 Ladder hinges and locks	.....	9-30
□ 9.3.5.7.4 Weather implications for portable ladders	.....	9-30
<b>9.4 Common working positions</b>	.....	<b>9-31</b>
■ 9.4.1 Static dimensions for common body positions	.....	9-31
<b>Exhibit 9.4.1</b> Anthropometric data for common working positions	.....	9-32
<b>9.4.2 Mobility in work space</b>	.....	<b>9-36</b>
■ 9.4.2.1 Mobile work space approval	.....	9-36
■ 9.4.2.2 Mobile work space dimensions	.....	9-36

	<b>Exhibit 9.4.2.2</b> Mobile work space dimensions and illustrations .....	9-37
<b>9.4.3 Standing workplaces</b>	.....	<b>9-38</b>
□ 9.4.3.1 Standing workplace and workbench dimensions .....		9-38
	<b>Exhibit 9.4.3.1</b> Standing workplace illustration and dimensions .....	9-39
<b>9.4.4 Seated workplaces</b>	.....	<b>9-39</b>
□ 9.4.4.1 Seated workplace guideline .....		9-40
□ 9.4.4.2 Seat compatibility .....		9-40
□ 9.4.4.3 Swivels and rollers .....		9-40
□ 9.4.4.4 Seating dimensions .....		9-40
	<b>Exhibit 9.4.4.4</b> Seated workplace dimensions and illustrations .....	9-41
□ 9.4.4.5 Knee space .....		9-42
□ 9.4.4.6 Seat cushioning .....		9-42
□ 9.4.4.7 The use of armrests .....		9-42
□ 9.4.4.8 Uncushioned stools and benches .....		9-42
□ 9.4.4.9 Footrests .....		9-43
□ 9.4.4.10 Temporary seats .....		9-43
	<b>Exhibit 9.4.4.10</b> Swing-away seat for short term use .....	9-43
<b>9.5 Standard console design</b>	.....	<b>9-43</b>
<b>9.5.1 Sit, sit-stand, and stand consoles</b>	.....	<b>9-43</b>
□ 9.5.1.1 Dimensions for console configurations .....		9-44
	<b>Exhibit 9.5.1.1 (a)</b> Standard console dimensions .....	9-44
	<b>Exhibit 9.5.1.1 (b)</b> Standard console illustration and dimensions key .....	9-45
□ 9.5.1.2 Selection of a standard console .....		9-46

<b>9.5.2 Horizontal wrap-around console alternatives</b>	.....	<b>9-46</b>
<b>Exhibit 9.5.2</b> Example of horizontal wrap-around console	.....	9-46
□ 9.5.2.1 Panel width	.....	9-46
□ 9.5.2.2 Panel angles	.....	9-46
■ 9.5.2.3 Dimensions with vision over the top	.....	9-46
■ 9.5.2.4 Width dimensions without vision over the top	.....	9-46
■ 9.5.2.5 Viewing angle	.....	9-46
<b>9.5.3 Vertical stacked segments for consoles</b>	.....	<b>9-47</b>
<b>Exhibit 9.5.3</b> Example of vertical stacked segments	.....	9-47
■ 9.5.3.1 Panel division	.....	9-47
□ 9.5.3.2 Height	.....	9-47
<b>9.5.4 Design and arrangement of multiperson consoles</b>	.....	<b>9-47</b>
■ 9.5.4.1 Selecting arrangements for team consoles	.....	9-47
<b>Exhibit 9.5.4.1</b> Basic and variations of multiperson console arrangements with an example control room arrangement	.....	9-48
□ 9.5.4.2 Selecting team console types and designs	.....	9-49
<b>Exhibit 9.5.4.2</b> Concepts of functional reach arc and equidistant visual arc for a stand console	.....	9-50
□ 9.5.4.3 Use of position coding	.....	9-50
■ 9.5.4.4 Control and display placement on stand consoles	.....	9-51
<b>Exhibit 9.5.4.4</b> Recommended placement areas for controls and displays on vertical and stand consoles	.....	9-52
□ 9.5.4.5 Special team sit-stand console and work space dimensions	.....	9-51
<b>9.6 Visual display terminals</b>	.....	<b>9-52</b>
■ 9.6.1 Visual display terminals, associated furniture, and office environment	.....	9-53



<b>9.7 Accommodating people with disabilities: accessible elements and space</b>	<b>9-53</b>
▪ 9.7.1 Accessibility - facilities, passageways, walks, and workplaces .....	9-53
□ 9.7.2 Reasonable accommodation of workspace to an individual .....	9-54
▪ 9.7.3 Office Rooms .....	9-54



## 9 Workplace design

The criteria and guidelines that follow apply to workplaces that are to be maintained by FAA personnel. Topics covered in this section include: general system level criteria and guidelines, the layout of workplaces, the design of passage areas, common maintenance working positions, console designs including arrangements for process control consoles, and referral information for workstations with visual display terminals.

### 9.1 General

The following general criteria and guidelines affect systems, equipment, and facility design. Compliance will help enhance the performance of FAA maintenance personnel and the systems they maintain. Some of the criteria and guidelines address the interaction of maintenance and operational activities.

- **9.1.1 Design for human activities.** Workplace and associated equipment designs shall systematically incorporate the effects of tasks, performance capabilities, physical dimensions, and viewing dimensions for maintainers (for example, technicians) and for associated operators (for example, NAS Operations Managers). Resultant design effects, their rationales, and the expected human performance outcomes shall be verified as agreed upon with the acquisition program office.

**Definition.** For this document, **workplaces** (pertaining to maintenance) are locations where FAA personnel must go in order to perform maintenance tasks on equipment or to control maintenance activities. These locations include the passageway, the areas where equipment is installed (for on-site, on-equipment tasks), repair shops, and remote maintenance control areas. Some maintenance activities will be associated with equipment controlled by operators. Thus, the same workplaces must accommodate both maintainers and operators.

- **9.1.2 Physical accommodation.** The physical dimensions of workplaces and equipment shall conform to the anthropometric and biomechanical characteristics of the specific population of users for whom the system is being designed and to the characteristics of the tasks to be performed. The rationale for and the design effects of the appropriate use of anthropometric and biomechanical data from the user population shall be verified as agreed upon with the acquisition program office. Anthropometric and biomechanical data are found in Section 14.

**Examples.** Those areas that deal with clearance dimensions that a large portion of the user population could be expected to use frequently or in a life threatening situation require as a minimum the 99th percentile value for clearance. Heavy traffic passageways and normal doorway clearances are examples. Similarly, the 1st percentile values for reach and strength are used as limiting

dimensions. These values ensure that the smallest personnel can reach and open escape mechanisms. In most other cases, the convention of designing for the 5th through 95 percentile is used for practical design related reasons. Male and female personnel are included in the anthropometric data. The higher percentile values are often dominated by male data and the lower values by female data (see section 14 and its references for treatments of anthropometric practice).

Verification methods that may be selected by the acquisition program office may, by way of example, include one or more of the following: reporting of plans, dimensions, analysis results, or rationale in a human factors deliverable document; measurements or demonstrations from drawings, scale mock-ups, simulations, or prototypes; review and approval of drawings; review and measurement or demonstration at a preliminary or critical design review; a special report or review; review of an exception rationale or waiver request; and inclusion in development and operational testing for measurement, evaluation, or demonstration.

- **9.1.3 Work space to permit access.** Space for maintenance access shall be designed into FAA systems and equipment. Accessibility is influenced by system maintenance concepts, procedures, and tasks. The design impacts of maintenance concepts, procedures, and tasks shall be determined and their effects upon space for accessibility and upon maintenance performance shall be verified as agreed upon with the acquisition program office.
- **9.1.4 Maintenance independence.** Workplaces, controls, and displays that are associated with maintenance activities should be separate from operator workplaces, controls, and displays.
- **9.1.5 Maintenance and operations interference.** Maintenance activities should not interfere with ongoing operator tasks. Where these activities would interfere and where simultaneous activities are necessary, redundant information should be provided to the operators for their ongoing diagnostic and emergency maintenance responsibilities. Controls and displays that are solely for maintenance should not be visible to operators but should be readily accessible when needed by maintenance personnel.
- **9.1.6 Illumination compatibility with operations.** Where simultaneous operations and maintenance activities are necessary, workplace illumination for maintenance activities shall be compatible with illumination requirements for operators' visual tasks. Where it is critical, the design shall ensure that adequate maintenance illumination shall not interfere with operator visual tasks.
- **9.1.7 Task and general illumination of work space.** Illumination for maintenance shall include general area

illumination and task illumination. Refer to section 13.4 for detailed illumination design criteria.

- **9.1.8 Special information and communications interfaces.** Workspace and interfaces for accessing maintenance information systems and maintenance communications systems shall be provided where these special maintenance linkages are appropriate in the design of FAA systems.

**Example.** Remote maintenance subsystems which include computers, terminals, modems, and networks provide special links to FAA maintenance information and communications systems.

- **9.1.9 Colors.** Colors and textures for FAA facilities shall be as agreed upon with the acquisition program office. Colors and textures for equipment shall be based upon FAA-STD-001B.

## 9.2 Workplace layout

The following design criteria and guidelines facilitate maintenance by addressing the locations of equipment within a workplace, by providing sufficient work space for access around and designed into equipment, and through appropriate design and layout of maintenance repair workstations.

### 9.2.1 Equipment layout

- **9.2.1.1 Traffic and congestion.** Equipment and workstations shall be located so as to minimize congestion in work flow or worker movement and to minimize interference with and from personnel traffic areas. The rationale and design features for work flow and traffic flow will be verified as agreed upon with the acquisition program office.
- **9.2.1.2 Equipment grouping.** Equipment and components maintained by the same technician should be grouped together so the technician will not have to move around in checking or working on the equipment. Equipment should be grouped so that no other type of technician has to remove equipment or components before the proper technician can obtain access to make replacements or repairs.

**Example.** Components that require frequent visual inspection of check points, adjustment points, cable-end connection and labels should be located in positions that can be seen easily.

- **9.2.1.3 Equipment arrangements for groups of workers.** When groups of two or more people need to be located within a work space, the groups and their equipment shall be arranged so that equipment can be shared, communications requirements can be minimized, necessary face-to-face communications and coordination are facilitated, mutual interference is minimized, and supervision is simplified.

- **9.2.1.4 Layout for safety.** All equipment and components should be located to minimize the possibility of equipment damage, personnel injury, or inadvertent actuation. Safety rationale and design consequences will be verified as agreed upon with the acquisition program office (see also paragraph 12.4.1.18 for OSHA requirements relating to the design and location of electrical installations and electrical utilization equipment).
- **9.2.1.5 Access interference.** Each unit of equipment and its components shall be designed and installed to ensure ease of replacement.
  - a. Whenever possible, each unit shall be located so that no other units or equipment must be removed to reach it.
  - b. Units shall not be located in recesses, behind, or under structural members or other equipment components where access or removal is difficult.
  - c. Technicians shall be able to open unit covers without interference from bulkheads, brackets, or other equipment.
- **9.2.1.6 No stacking.** Equipment units shall not be stacked on top of each other.
- **9.2.1.7 Criticality for maintenance.** The most critical units (based on mission, functions, and tasks) shall be located so as to be most accessible.
- **9.2.1.8 Frequency of maintenance.** Where criticality is not a factor, units expected to require more total maintenance attention (for example, more frequent and longer durations of maintenance) shall be more accessible.
- **9.2.1.9 Visual access.** Units shall be located so that check points, adjustment points, connectors, and labels face the technician and are not hidden by other units. Workspace around the unit shall permit easy visual access.
- **9.2.1.10 Clear visual inspection.** Units and components that require frequent visual inspection shall be located so that items being inspected (for example, desiccators or fuses) can be seen easily without removal of panels, covers, or other units.
- **9.2.1.11 Front removal.** Units of equipment should be designed for removal of components and, if applicable, subordinate units, through the front rather than the back of the equipment.
- **9.2.1.12 Floor space for work and passage.** Floor space shall be planned and designed to ensure the following: (a-f are required by 29 CFR 1910.22)
  - a. floor space for work areas and for aisle space do not occupy the same space and thus the work and passage do not interfere,

- b. material and equipment handling tasks are to be used in sizing work and aisle spaces; necessary turning space for materials and equipment is included,
  - c. the work and aisle space can be kept clean,
  - d. storage space for material and equipment does not interfere with work or passage,
  - e. floor work and aisle space are free of protruding nails, splinters, holes, loose boards, or other loose materials.
  - f. permanent aisles and passageways are appropriately marked,
  - g. floor loading limits are conspicuously displayed to prevent structural overloading,
  - h. floor space around electrical utilization equipments is provided in accordance with paragraph 12.14.1.18, and
  - i. free floor space of at least 1.2m (4 ft) is to be provided in front of each equipment rack.
- **9.2.1.13 Depth of the work area.** Clearance from the front of a rack to the nearest facing surface or obstacle shall be at least 1.07 m (42 in). The minimum space between rows of cabinets containing drawers shall be 200 mm (8 in) greater than the depth of the deepest drawer.
  - **9.2.1.14 Lateral work space.** The minimum lateral work space for racks having drawers or removable equipment shall be as follows (measured from the drawers or equipment in the extended position):
    - a. for racks having drawers of removable items weighing less than 20 kg (44 lb), allow 460 mm (18 in) on one side and 100 mm (4 in) on the other, and
    - b. for racks having drawers or removable items weighing over 20 kg (44 lb), allow for two person access (one on each side): 460 mm (18 in) on each side.
  - **9.2.1.15 Rear access space.** If the technician must have access to the back of an entire rack or panel-mounted unit, the unit shall be installed with sufficient clearance to permit the maintainer to perform all required maintenance tasks, including the removal of the rear panel(s).

## 9.2.2 Work space features designed into equipment

### 9.2.2.1 Designed-in access

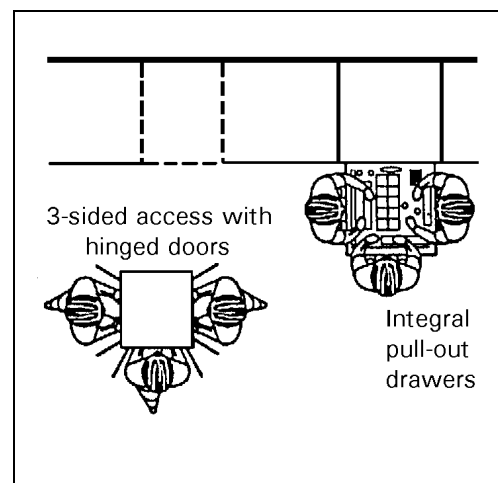
Access space and features for incorporating drawers in equipment are discussed in this section. Other access criteria are found in section 6.4.

- **9.2.2.1.1 Access space for effective maintenance.** Equipment shall be designed to allow effective maintenance by providing sufficient space for maintenance personnel to access the equipment and components. This space shall permit maintainers with 95th percentile values on task related dimensions to have sufficient access and space to perform the maintenance tasks and to use the tools necessary for the tasks. Reach limits shall permit the 5th percentile maintainer access to perform the tasks with the appropriate tools.

**Example.** Where maintenance is to be performed at the equipment location, equipment design can include techniques that use the chassis as an integral part of the structure of the equipment, for example, pull out drawers or shelves. These techniques ensure that all components can be reached with a minimum of access space (see exhibit 9.2.2.1.2). (See also Section 6, Designing equipment for maintenance.)

- **9.2.2.1.2 Panels and access doors.** Equipment with panels or hinged access doors may need to be removed before the equipment can be maintained or serviced. Access openings should be provided on at least three sides. Exhibit 9.2.2.1.2 illustrates the space required for three sided access with hinged doors versus that required for integral pullout drawers.

**Exhibit 9.2.2.1.2** Access space through integral design



**Discussion.** Less room is generally required to work on equipment with pull out shelves or drawers than on equipment with access doors or panels. Built in pullout shelves and drawers are preferred to hinged doors or removable panels.

- **9.2.2.1.3 Component locations for access.** Components to be serviced, replaced, or repaired on the equipment should be placed in a plane parallel to and within 150 mm (6 in) of the access openings when hinged doors or removable panels are used.



### 9.2.2.2 Foot space

When personnel must stand or sit near equipment, foot space needs to be provided. Such space is covered in this section. Seated positions will also require knee room which is treated under seated work space design in paragraph 9.4.4.5.

- **9.2.2.2.1 Kickspace.** All cabinets, consoles, and work surfaces that require an operator or maintainer to stand or sit close to their front surfaces shall contain a kick space at the base of the front surfaces of at least 100 mm (4 in) deep and 100 mm (4 in) high.

### 9.2.2.3 Work surfaces

Work surfaces for standing or seated positions are treated in this section. Visual display terminals are special cases which are treated in section 9.6.

- **9.2.2.3.1 Work surfaces for standing positions.** Work surfaces shall be consistent with the needs of jobs and tasks. Surfaces for standing work shall be 915 mm plus or minus 15 mm (36 in plus or minus .6 in) from the floor. Where machine parts or equipment are manipulated, the surface shall be at least 760 mm (30 in) wide. In all cases the work surface shall be at least 407 mm (16 in) deep. This lateral depth may be increased based upon the demands of the job.
- **9.2.2.3.2 Work surfaces for seated positions.** Surfaces for seated operations shall be 740 - 790 mm (29 - 31 inches) above the floor. Width and depth shall be the same as in paragraph 9.2.2.3.1.

**Discussion.** For light precision work, work surface height can be increased within the above limits. For work requiring increased force, the work surface height can be lower.

- **9.2.2.3.3 Writing surfaces.** Writing surfaces shall be at least 610 mm (24 in) wide and 407 mm (16 in) deep.
- **9.2.2.3.4 Task sizing of work surfaces.** When a work surface is used for more than one task, the surface dimensions for tasks requiring the most space shall be used.

### 9.2.2.4 Storage

- **9.2.2.4.1 Storage space.** Adequate space for storage of manuals, worksheets, test equipment, tools and other materials that are required for use by operational or maintenance personnel shall be provided on consoles and, where appropriate, on equipment.

### 9.2.3 Workstations for maintenance repair

Workstations that are specifically designed for maintenance activities are treated in the following paragraph. Criteria for detailed maintenance bench designs are included. Generally applicable consoles are treated later in section 9.

**Definition. Workstations** are workplaces with special accommodations, furnishings, and equipment that are designed for the intended worker tasks. Desks, offices, repair benches, tools, equipment, and computer terminals

are examples of these special accommodations and equipment. Workstations are designed as areas for one or more workers to use in accomplishing purposeful tasks or jobs.

- **9.2.3.1 Sizing.** Maintenance repair workstations shall be large enough to handle the largest equipment or component that will require repair.
- **9.2.3.2 Special equipment.** Maintenance repair workstations shall be designed to accommodate general purpose, specific purpose, and automated diagnostic and test equipment appropriate to the expected maintenance tasks.

## 9.3 Design of passageways

In complex systems and facilities, passageways are necessary for maintenance personnel to be able to get to equipment areas and maintenance works stations. These personnel may be required to carry tools and to move equipment through passageways including over steps and through entrances. This subsection covers: traffic area walkways; special spaces such as catwalks (to be avoided when possible); platforms and elevators; entrances and exits; and ramps, stairs, and ladders.

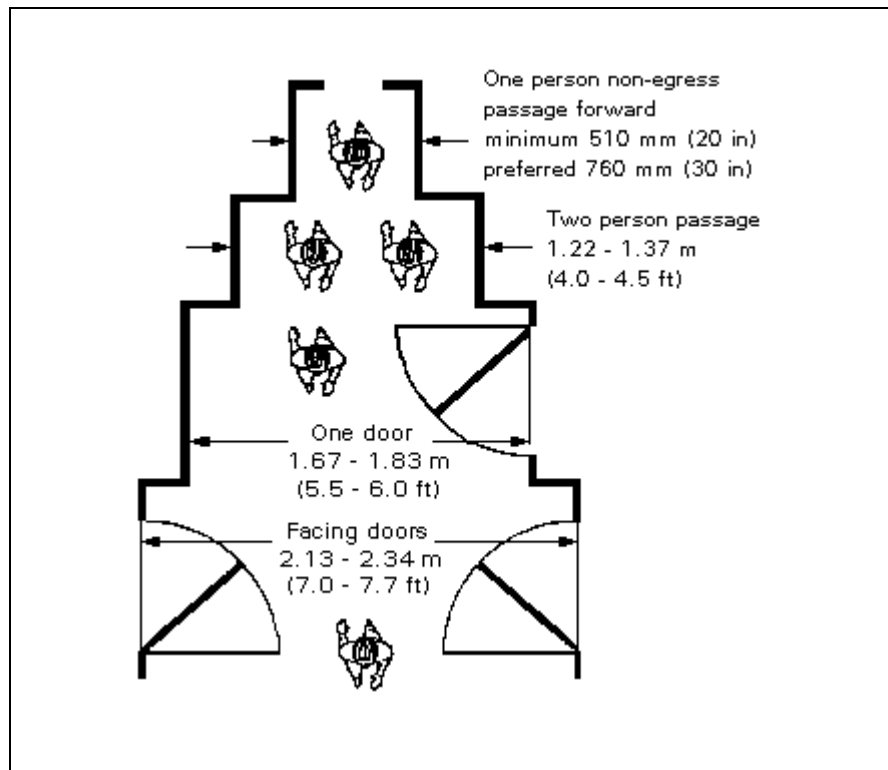
**Definitions.** **Passageways** for the purpose of this document are areas across which people must pass for work purposes. **Walkways** are areas designated for walking; **corridors** are walkways that are physically restricted by walls or the like.

### 9.3.1 Walkways and traffic areas

- **9.3.1.1 Corridors.** Corridor widths shall be designed for the peak traffic load expected, for traffic directions, and for the number of entrances and exits in the area. To allow personnel to move with tolerable restrictions, the widths of corridors shall equal or exceed those given in exhibit 9.3.1.1 (see paragraph 9.3.4.4.1 for OSHA implications when a corridor is designated as part of an emergency egress).
- **9.3.1.2 Added clearance.** Adequate clearance should be allowed for personnel wearing bulky clothing and carrying equipment.

**Example.** A person can move through a corridor 510 mm (20 in) wide with some difficulty; however, a one-person corridor for bulky clothes and comfortable travel should be at least 760 mm (30 in) wide (see exhibit 9.3.1.1). The dimensions of equipment to be carried or transported may add width to these minimum and preferred values.

- **9.3.1.3 Floors.** Passageway floors shall be provided with nonskid or other high friction surfaces (see paragraph 9.3.3.3.1 for criteria for nonskid surfaces).

**Exhibit 9.3.1.1** Walkway and passageway dimensions

- **9.3.1.4 Traffic areas.** Traffic area and traffic flow design should be based upon:
  - a. a consideration of task based activities in and around workstations,
  - b. location of workstations and traffic areas so that they interfere minimally with each other,
  - c. a consideration of the necessary movements of equipment in the work and traffic areas,
  - d. a consideration of normal traffic conditions, worst cases, and emergency conditions, and
  - e. a consideration of means by which to avoid collisions and to maximize traffic efficiency.

The rationale for and design consequences of these systematic considerations of traffic flow shall be verified as approved by the acquisition program office.

### 9.3.2 Catwalks, tunnels, and crawl spaces

Catwalks, tunnels, and crawl spaces are specialized facility features used to accommodate unique space or environmental limitations that preclude normal corridors or walkways.

- **9.3.2.1 Approval for use.** Catwalks, tunnels, and crawl spaces shall not be used unless explicitly approved in advance of design by the acquisition program office. If approved, they shall be designed to accommodate 99th percentile males with such bulky clothing, equipment, and tools as are appropriate to the traffic and tasks.
- **9.3.2.2 Access and rescue in special passageways.** Access space shall be provided for one or two people to rescue an incapacitated 95th percentile male from anywhere in the special passageway or workspace. The feasibility of such rescues shall be verified as agreed upon with the acquisition program office.
- **9.3.2.3 Guardrails and nonskid surfaces.** An open catwalk shall have guardrails and nonskid floor surfaces in accordance with paragraphs 9.3.3.4.2 and 9.3.3.3.1. Guardrails, handrails, and handholds shall facilitate getting on and off the catwalk and help prevent accidental falls from the catwalk (see paragraph 9.3.3.4.2 for guardrail dimensions).
- **9.3.2.4 Catwalk and ladder orientation.** Where feasible, stairs or ladder entrances to the catwalk shall be oriented at 90 degrees to the catwalk.
- **9.3.2.5 Minimum catwalk width.** The minimum catwalk floor width shall be 460 mm (18 inches) to accommodate walking one foot in front of the other and carrying tools or equipment.
- **9.3.2.6 Enclosed space ventilation.** Enclosed catwalks, tunnels, and crawl spaces shall have adequate air ventilation to sustain their maximum permissible personnel numbers for an indefinite period. Consideration of both temperature and air quality shall be included when determining adequacy.
- **9.3.2.7 Movement or work without mechanical aid.** When these special passageways require bending, stooping, or crawling, personnel with 99th percentile dimensions shall be able to accomplish the movement and, where applicable, work without the assistance of other people or of mechanical aids. When special passageways are used, movement capability and work performance capability shall be verified as agreed upon with the acquisition program office.

### 9.3.3 Platforms, elevators, inclimators

This subsection covers raised platforms, portable platforms, floor surface areas for platforms and walking work areas, guardrails, elevators, inclimators, and hydraulically operated work platforms.

**Note.** 29 CFR 1910.31 provides extensive rules for mobile elevating work platforms, 29 CFR 1910.28 addresses fall protection systems, and 29 CFR 1910.30 addresses scaffolding. These codes have precedence if building construction or maintenance applies.

### 9.3.3.1 Raised platforms

- **9.3.3.1.1 Raised platform minimum dimensions.** Platforms that raise or position personnel at a comfortable working distance from equipment shall be at least 610 mm wide (24 in) and 910 mm (36 in) long.
- **9.3.3.1.2 Hands free work area.** Platform design shall permit both of the users hands to be free for work. Guardrails shall be provided in accordance with paragraph 9.3.3.4.1 below.
- **9.3.3.1.3 Permissible gaps with equipment.** Platform design shall provide a continuous closure between the equipment and the platform. The average conformation shall be within 50 mm (2 in); gaps greater than 150 mm (6 in) shall be avoided. Contact plates, cushions, bumpers, or pads shall be used, as necessary, to protect the equipment surfaces.
- **9.3.3.1.4 Platform strength.** The platform shall have sufficient strength to hold the worker(s) plus the heaviest tools and equipment expected plus a safety factor consistent with design practice for the structural materials. Assume 113.4 kg (250 lb) for each person.
- **9.3.3.1.5 Test equipment support.** If test equipment will be used, the design shall provide support for test equipment at the appropriate height for its use.

### 9.3.3.2 Portable platforms

- **9.3.3.2.1 Portable platforms.** Portable platforms should be lightweight in their material and fully collapsible.
- **9.3.3.2.2 Platform wheels and brakes.** Any platform on wheels shall have brakes and wheel locks.

### 9.3.3.3 Floor surfaces for walkways and platforms

- **9.3.3.3.1 Surfaces for platforms and work areas.** Exterior platforms and similar work areas shall be constructed of open metal grating. Where grating is impractical and for alternatively constructed interior platforms and work passageways, floor surfaces shall be treated with non skid material that conforms to MIL-W-5044 and that is applied in accordance with MIL-W-5050.

### 9.3.3.4 Guardrails, toeholds, screens, and handholds

- **9.3.3.4.1 Guardrails.** All open sides of personnel platforms shall be equipped with guardrails which have at least two rails (an

intermediate rail and top rail). The open area where work is to be done shall be guarded without interfering with work tasks.

- **9.3.3.4.2 Guardrail dimensions.** The top rail height shall be at least 1.1 m (42 in). The distance between the platform edge and the centerline of the railing shall not exceed 65 mm (2.5 inches). The rails shall be between 37 mm (1.5 in) and 75 mm (3 in) in diameter. In accordance with 29 CFR 1910.23 (e), this railing height and diameter range describe the OSHA standard guard railing for platforms, ramps, floor openings, hatches, and wall openings (that a person could fall into) (see also paragraph 9.3.4.6.3).
- **9.3.3.4.3 Toe board or guard screen.** A toe board of 10 cm (4 in) to 15 cm (6 in) shall be used to guard floor openings or a guard screen shall extend from the floor base to the intermediate rail.

**Note.** OSHA regulations 29 CFR 1910.23 (e) permits a 102 mm (4 in) toeboard as a minimum.

**Discussion.** The guard screen is used to prevent a person who falls on the platform from falling from the platform. It can also prevent most tools, parts, and equipment from falling from the platform. Toe boards are intended to prevent tools, parts, and equipment from falling as well as to prevent the worker's foot from slipping off the edge of the platform.

- **9.3.3.4.4 Handholds.** Handholds shall be furnished where needed to assist in climbing onto a platform or as aids in performing the intended maintenance tasks from the platform (same as paragraph 12.2.2.8).
- **9.3.3.4.5 Handholds, guardrails for adverse conditions or motion.** Handholds and guardrails shall be provided where personnel must stabilize themselves because of high winds, ice, fog or other hazards and when working in moving vehicles.

### 9.3.3.5 Elevators, and hydraulically operated platforms

- **9.3.3.5.1 Elevators, inclinators, and hydraulic work platforms.** Where these passage or work aids are needed, the following operating safety features shall be included:
  - a. Maximum load signs shall be located where they can be easily seen.
  - b. Guards shall be used to prevent accidental operations of the lift.
  - c. An easily reachable capability for manually lowering the platform or elevator shall be provided when feasible.

d. Floor surface treatment shall be in accordance with the treatment of open platforms in paragraph 9.3.3.3.1.

- **9.3.3.5.2 Designed-in safety features.** The following designed-in features shall be provided:

a. limit stops, to prevent injury to personnel and damage to equipment, and

**Definition. Limit stops** are mechanical mechanisms designed to restrict a moving object or part by stopping it at predetermined (limit) positions.

b. an automatic fail-safe brake or other self-locking device in case of lift mechanism failure.

### 9.3.4 Entrances and exits

This section covers general guidelines for

entrances and exits. Doorways and normal hinged doors for individual and multi-person entry, alternatives to normal hinged doors, emergency doors, hatches, and emergency escape hatches are treated.

#### 9.3.4.1 General

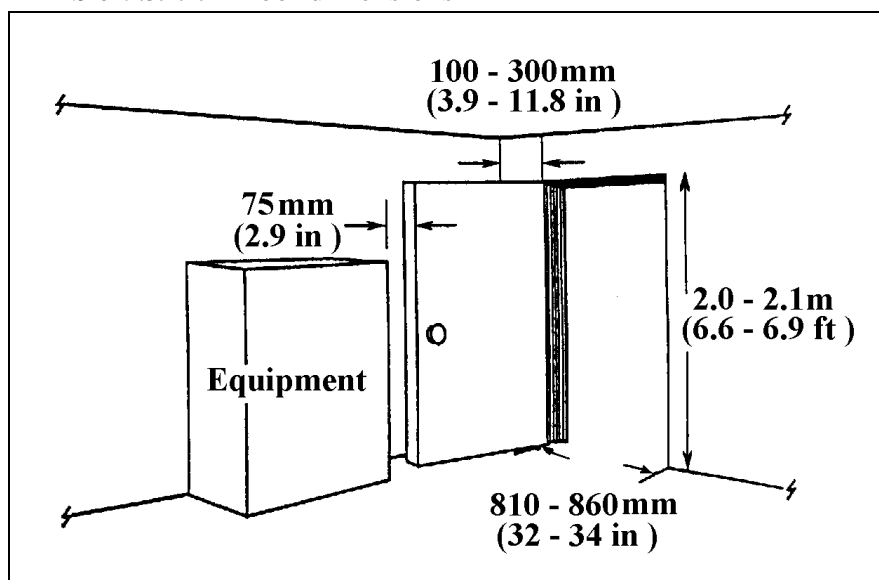
- **9.3.4.1.1 Routine.** Enclosed work areas should have conventional entrances and exits for routine access and to permit unrestricted flow for all anticipated traffic and movements of equipment. They should be located so that personnel who are entering or leaving will not inadvertently operate or block access to controls or displays or otherwise interfere with ongoing work in the area.
- **9.3.4.1.2 Population accommodation.** Entrances and exits that handle heavy traffic, either routinely or in emergency conditions, shall be designed to accommodate the entire population of users and shall equal or exceed the 99th percentile dimensions of that population.

#### 9.3.4.2 Doorways and hinged doors

- **9.3.4.2.1 Door dimensions.** Hinged doors that allow the passage of one person shall have at least the dimensions shown in exhibit 9.3.4.2.1.

**Note.** If the depicted area is a means of exit 29 CFR 1910.37 (h)(2)(i) requires that the floor to ceiling dimension be at least 2.29 m (7.5 ft) and any protrusions from the ceiling be no less than 2.04 m (6.7 ft).

Exhibit 9.3.4.2.1 Door dimensions



- **9.3.4.2.2 Door width expanded for carrying equipment.** If large equipment or tools must be carried or transported through the doors, width dimensions shall be increased accordingly.
- **9.3.4.2.3 Door clearances.** When a door opens inward next to a perpendicular wall, a clearance of at least 100 mm (4 in) between the door at the hinge and the plane of the wall shall be provided. Equipment or furniture shall not be positioned within 2.9 inches of the swing path of the door (see exhibit 9.3.4.2.1).
- **9.3.4.2.4 Door opening direction.** If the normal traffic density and the exiting personnel traffic in emergency conditions are expected to be low, then hinged doors shall open inward rather than outward into a corridor. Opening inward will prevent injury to personnel using the corridor. If exiting traffic volume is expected to be high the door shall have a see-through window and shall open outward to ensure the feasibility of exiting in an emergency.
- **9.3.4.2.5 Doors for two people.** If it is necessary for two or more people to go through a doorway or archway simultaneously, the opening shall be at least 1.4 m (54 in) in width and 2.0 m (77 in) in height.
- **9.3.4.2.6 Door sizes or quantities.** The sizes of doors or numbers of doors needed should be determined by the number of users routinely or under emergency conditions who need simultaneous access and the size of equipment and tools that must be carried or transported through the door(s).



### 9.3.4.3 Alternative door guidelines

- **9.3.4.3.1 Sliding and folding doors.** If horizontal or vertical sliding or folding doors are used to allow large pieces of equipment or vehicles to pass through, these large doors should not be the only personnel exit as they may jam. Thus, alternative exits should be available. If horizontal or vertical sliding or folding doors are the only exits available for personnel to egress the building, a hinged door for personnel entrance and exit should be built into the sliding or folding door.
- **9.3.4.3.2 Swinging doors.** Swinging doors should be used in pairs, one for each direction of traffic, with the doors separated by a center door post. They should be hinged at the center post and should have openings or windows for visual access to oncoming traffic. Spring closure mechanisms should be avoided with a light door as this closing arrangement can be hazardous. A spring mechanism should only be used when the door size or weight prevent manual opening and closing.
- **9.3.4.3.3 Revolving doors.** Revolving doors are hazardous and should not be used.
- **9.3.4.3.4 Floor to ceiling glass doors or windows.** Where floor to ceiling doors or windows are used, the glass area should be patterned or labeled so that users will not mistake it for an unobstructed passageway.

### 9.3.4.4 Emergency doors and exits

- **9.3.4.4.1 Space for exit.** Emergency exits shall allow enough space for rapid exit of all occupants, including any who must carry essential equipment or wear bulky clothing. Escape shall be possible without danger of personnel injury or damage to the equipment being carried. 29 CFR 1910.36-37 shall be used in determining "ways of exit" design requirements for FAA buildings and facilities.

**Discussion.** OSHA and National Fire Protection Association codes specify the design requirements for "ways of exit" from buildings and facilities. A designated means of emergency egress requires a minimum of 18 inches of unobstructed "way of exit" travel from any point in a structure to an exterior safe public way. Design requirements for any unobstructed "way of exit" are functions of the nature of the building construction and contents, the maximum occupancy capacities of its components, and the arrangement of designated "ways of exit."

- **9.3.4.4.2 Emergency door and exit design and construction.** Emergency doors and exits shall be designed and constructed so that they:

- a. are simple to operate,
- b. are readily accessible,
- c. are clearly designated,
- d. are unobstructed,

**Discussion.** A door that is not blocked in the direction of exiting travel is not considered an obstruction. An inside door under low occupancy conditions cannot be less than 71 cm (28 in) in width. For occupancy capacities of 60 to 100 people, the unobstructed minimum widths would range between 76 to 112 cm (30 to 44 in), respectively. When other conditions are considered these minimal dimensions could be larger. If the depicted corridors in exhibit 9.3.1.1 are designated parts of an emergency "way of exit", the minimal width of the unobstructed way would exclude the swing areas where doors open into the "way of exit."

- e. are simple to locate and operate in the dark,
- f. are capable of opened in 3 sec or less,
- g. require 44 and 133 N (10 to 30 lbs) of operating force to open,

**Definition.** The **symbol N** is a metric term for the force measure called a **Newton**. One pound force in the English measurement system is equal to 4.4482 Newton (1 lbf = 4.4482 N).

- h. permit exit by one person in 5 sec or less, and
- i. do not in themselves, or in their operation, constitute a safety hazard.

**Note.** This paragraph is the same as paragraph 12.2.1.6.

According to 29 CFR 1910.37 (h)(2)(i), ceiling areas along a means of egress (including exterior escape paths) shall be at least 2.29 m (7.5 ft) above the floor and protrusions shall not be lower than 2.04 m (6.7 ft).

- **9.3.4.4.3 Changes in elevation in a "way of exit".** When a designated way of exit is not substantially level, these differences in elevation shall use ramps or stairs (see also paragraph 9.3.5.1.2 to determine when to use ramps or stairs).
- **9.3.4.4.4 Exit signs.** 29 CFR 1910.37 (q) requires that any exit and "way of exit" not immediately visible to occupants shall have a distinctive sign reading "EXIT" in letters not less than 15.2 cm (6 in) high and with principal strokes not less than 2.0 cm (.75 in). Other non exit or non "way of exit" doors or passages shall be identified as to their function or shall have a sign reading

"NOT AN EXIT." Signs shall be suitably and reliability lit with no less than five foot candles on the illuminated surface. Other internally illuminated and transilluminated lights shall be provided for reduced illumination environments. Exits signs with arrows pointing the direction of the way of exit shall be display where ever the way is not immediately apparent. Other lights and displays shall not be of sufficient brightness to interfere with or detract attention from exit signs.

### 9.3.4.5 Hatches

- **9.3.4.5.1 Use of hatches for maintenance purposes.** For maintenance purposes, hatches shall only be used with approval of the acquisition program office.
- **9.3.4.5.2 Flush with surfaces.** Where structural considerations permit, hatches shall be flush with the floor or wall surfaces.
- **9.3.4.5.3 Hatch opening motion.** Hatches shall open with a single motion of the hand or foot.
- **9.3.4.5.4 Hatch opening and closing forces.** If a handle is used, the unlocking force shall not exceed 90 N (20 pounds). Overhead hatches shall require no more than 220 N (50 pounds) for opening and closing or shall not exceed the fifth percentile arm and hand strength of the user population, whichever is less.
- **9.3.4.5.5 Clearance dimensions for hatches.** Clearance dimensions for size and passage shall be based upon the 99<sup>th</sup> percentile values for the expected population. In all cases, hatches shall accommodate suitably clothed and equipped maintainers together with any equipment they are expected to carry.
- **9.3.4.5.6 Limiting dimensions for hatches.** Limiting dimensions for location and operability shall be based upon the 1st percentile values for females in the expected user population.

**Discussion.** Clearance dimensions influence the size for access, accommodation, and entrance by the larger people in the user population. Limiting dimensions permit the smaller people in the user population to reach or view controls and displays and to manipulate latches, handles or accesses.

- **9.3.4.5.7 Rescue requirements.** Where rescue of personnel may be required, openings shall be large enough to accommodate two suitably clothed rescuers.
- **9.3.4.5.8 Rectangular hatch minimums.** When rectangular hatches are used, they shall meet or exceed the minimal whole body dimensions of paragraph 9.3.4.6.1.

9.3.4.6 Whole body access

- 9.3.4.6.1 **Whole body access.** Dimensions for whole body access shall meet or exceed those shown in exhibit 9.3.4.6.1. Where there is a need to step down through an access and the step distance exceeds 690 mm (27 in), foot rests or steps shall be provided.

Exhibit 9.3.4.6.1 Whole body access dimensions

Clothing	Light		Bulky	
	A	B	A	B
Top and bottom access	330 mm (13 in)	580 mm (23 in)	410 mm (16 in)	690 mm (27 in)
Side access	660 mm (26 in)	760 mm (30 in)	740 mm (29 in)	860 mm (34 in)

Note: Dimensions shown are based on male data

- 9.3.4.6.2 **Emergency escape hatches.** Emergency escape hatches shall accommodate the equipment and clothing which escaping personnel will be carrying and wearing. These hatches shall be clear of all external obstructions and shall be located to avoid external hazards. The minimum and preferred dimensions for special emergency escape hatches are: (1) rectangular minimum: 405 mm by 610 mm (16 in by 24 in), preferred 510 mm by 710 mm (20 in by 30 in); (2) square minimum: 460 mm (18 in), preferred 560 mm (22 in); (3) circular minimum 560 mm (22 in), preferred 710 mm (30 in).

- **9.3.4.6.3 Floor hatches and open holes.** A permanent or temporary standard guard railing or a person (as appropriate) shall guard all floor hatches or open holes (even those in walls) that a person could fall through. (Permanent stairs are subject to other railing rules.) Characteristics of these standard guard rails are found in 9.3.3.4.2 and subsequent exhibits.

### 9.3.5 Ramps, ladders, stairs

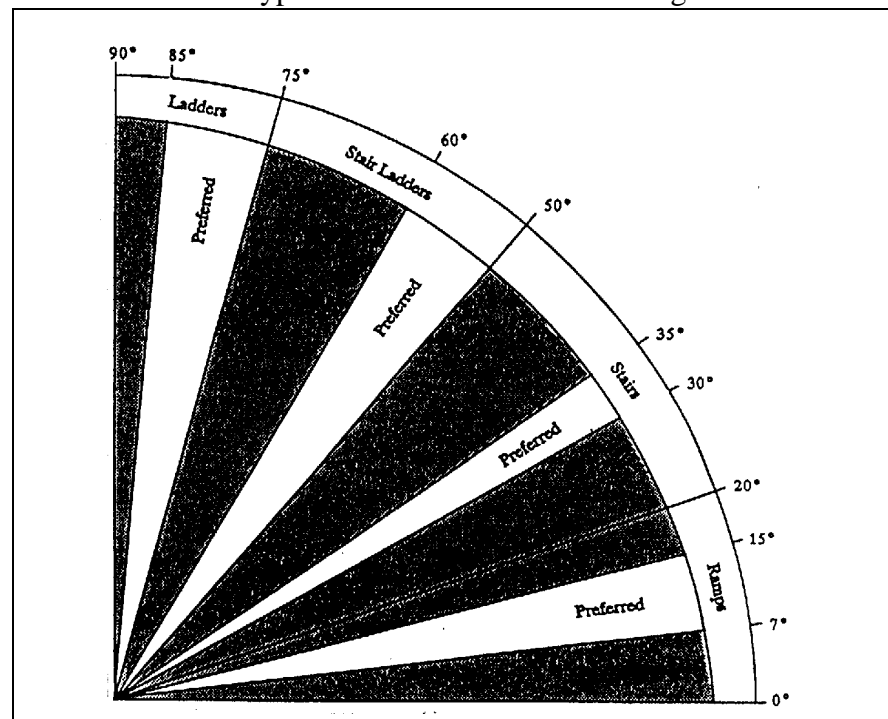
Criteria and guidelines are provided below for selecting and using structures for making changes in elevation of ramps, stairs, and ladders. Common design criteria for these structures are provided as are detailed criteria and guidelines for ramps, stairs, stair ladders, fixed ladders and portable ladders. Stair ladders have steps rather than rungs. The structure that gives the safest and most efficient passage is to be selected.

**Note.** The criteria and guidelines for ramps specified in this section, apply to "working" ramps (for example, ramps for forklifts from a dock down to the ground) or those used for purposes other than for wheelchair accesses.

#### 9.3.5.1 Selection and uses for specific applications

- **9.3.5.1.1 Selection.** The selection of ramps, stairs, stair-ladders, or fixed ladders for specific applications shall be based on the angle of ascent required and the critical criteria levels in exhibit 9.3.5.1.1.

**Exhibit 9.3.5.1.1** Type of structure in relation to angle of ascent



- **9.3.5.1.2 When to use.** Ramps, stairs, and ladders shall be provided whenever operators or maintenance personnel must change elevation abruptly by more than 305 mm (12 in). These structures shall be used, when appropriate, for passage over low objects (for example, pipes, lines, and ridges). (See paragraph 9.3.4.4.3 for ramps used as a "way of exit.")

**Note.** 29 CFR 1910.27 (e) states that the preferred range for fixed ladders is from 60-90 degrees; other sources stress 75-85 degrees and suggest avoiding the near vertical 85-90 degrees range as being difficult and dangerous to climb and descend.

- **9.3.5.1.3 For heavy carrying.** Apply the following guidance when selecting structures over which equipment or tools must be carried:
  - a. Ramps, elevators, or equivalent means should be provided when maintainers must carry or transport heavy or bulky equipment.
  - b. Stairs and steps should not be used where the maintainer must carry bulky loads or loads in excess of 13 kg (29 lbs).
  - c. Ladders should not be used when maintainers carry equipment because both hands should be free to grasp and climb ladders.

Exceptions. Vehicular-boarding ladders are not considered to be stair ladders or fixed ladders. Thus, the guidelines in 9.3.5 do not apply. (However, both hands should also be free to grasp these ladders.)

### 9.3.5.2 Common design requirements

Ramps, stairs and ladders share the following design requirements.

- **9.3.5.2.1 Material characteristics.** Ramps, stairs, and ladders shall be constructed of materials that are lightweight, nonconductive, splinter-proof, waterproof, weatherproof, humidity-resistant, and resistant to chemical action. They shall be designed to take into account the environmental conditions, including inclement weather (for example, snow, ice, mud, sand, and wind), if applicable. If de-icing is applicable, they shall be designed for hot water or steam de-icing.
- **9.3.5.2.2 Carrying strength of the structures.** These structures shall be designed to withstand the total weight of the largest combination of personnel and carried equipment likely to be on them at one time. These estimates shall be multiplied by a safety factor appropriate to the materials used. Use 113.4 Kg (250 lb) per person to estimate personnel weight.

- **9.3.5.2.3 Nonskid floor surfaces.** These structures shall be provided with nonskid surfaces on all areas where personnel are expected to walk or stand to work (see paragraph 9.3.3.3.1 for criteria for nonskid materials).
- **9.3.5.2.4 Warning labels.** These structures shall have symbols or placards that warn against any hazards associated with their use, (for example, low overhead obstructions, possible shock, and load limits).
- **9.3.5.2.5 Handrails.** These structures shall be equipped with a handrail on each side. Where personnel could fall into an open area under the handrail, an intermediate level guardrail shall be provided.
- **9.3.5.2.6 Proper illumination.** These structures shall be provided with appropriate illumination (see section 13.4 for illumination criteria).

### 9.3.5.3 "Working" ramps

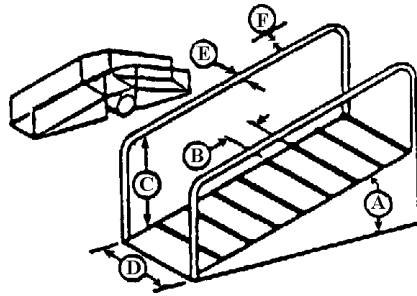
The criteria and guidelines for ramps specified in this section, apply to "working" ramps (for example, ramps for forklifts from a dock down to the ground) or those used for purposes other than for wheelchair accesses.

- **9.3.5.3.1 Dimensions for ramps.** Dimensions for ramps are given in exhibit 9.3.5.3.1. If feasible, dimensions shall conform to the recommended best values. In all cases, dimensions shall be within the specific minimum and maximum limits shown in the exhibit.

**Note.** In exhibit 9.3.5.3.1, the minimal and best handrail height, diameter, and hand clearance comply with OSHA's 29 CFR 1910.23 (e).

- **9.3.5.3.2 Ramps for pushing or pulling equipment on carts.** When ramps are used to push or pull carts, the designer shall stay within human strength capabilities in establishing the angle of inclination (see paragraph 14.5.3.1 for strength limitations).

**Exhibit 9.3.5.3.1** Critical dimensions for ramps



	Min.	Max.	Best
A Angle of rise	-	20	7-15
B Distance between cleats	23 cm (9 in)	41 cm (16 in)	36 cm (14 in)
C Height of handrails	95 cm (36 in)	107 cm (42 in)	107 cm (42 in)
D Width	95 cm (36 in)	-	-
E Diameter of handrail	4 cm (1.5 in)	8 cm (3 in)	4 cm (1.5 in)
F Clearance around handrail	8 cm (3 in)	-	8 cm (3 in)

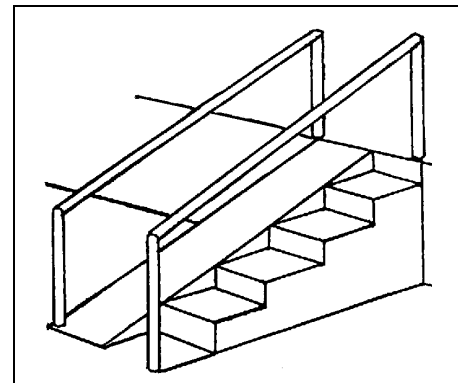
□ **9.3.5.3.3 Combined vehicular or cart and personnel traffic.**

Stairs should be provided for personnel when vehicles and pedestrians share a ramp and the angle of ramp inclination exceeds 7 degrees.

Personnel traffic areas should be off to the side or on both sides of the vehicle areas.

Vehicular traffic and walking traffic should be clearly separated by markings and handrails. Exhibit 9.3.5.3.3 illustrates a ramp and stairs combination with a pedestrian area on the right side.

**Exhibit 9.3.5.3.3** Combined ramp and stairs



- **9.3.5.3.4 Handrails for ramps.** Ramps for pedestrian traffic should have handrails.
- **9.3.5.3.5 Nonskid materials for ramps.** Nonskid materials should be used on the floor area of ramps wherever pedestrian



traffic is expected. (See paragraph 9.3.3.3.1 for criteria related to nonskid materials.) Cleating of ramps facilitates footing for walking and rolling equipment on these inclines. Where special environmental conditions require cleating of ramps, cleats should be spaced 360 mm (14 in) apart and run from handrail to handrail at right angles to traffic. Exhibit 9.3.5.3.1 gives preferred and criterion dimensions for cleated ramps.

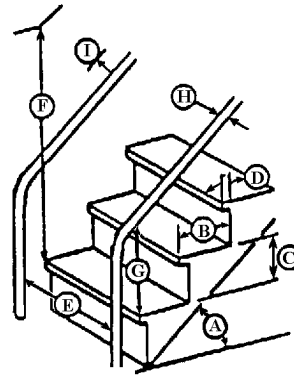
- **9.3.5.3.6 Ramp landings.** Ramps shall have level landings at the top and bottom of each ramp and each ramp run. Landings shall have the following features:
  - a. the landing shall be at least as wide as the ramp run leading to it,
  - b. the landing length shall be a minimum of 1.53 m (60 in) clear,
  - c. if ramps change direction at landings, the minimum landing size shall be 1.53 m by 1.53 m (60 in by 60 in), and
  - d. if a doorway is located at a landing, then the area in front of the doorway shall comply with section 9.3.4.2.

#### 9.3.5.4 Stairs

- **9.3.5.4.1 Dimensions for stairs.** Dimensions for stairs are given in exhibit 9.3.5.4.1. If feasible, stair dimensions shall conform to the recommended best values. In all cases, stair dimensions shall be within the minimum and maximum values shown in the exhibit.
- **9.3.5.4.2 Landings, stair lengths, riser, and tread dimensions.** There should be a landing for, at least, each floor level and other landings are recommended for each ten to twelve treads. Riser heights and the height to landings should be uniform. Long flights of stairs should be avoided.
- **9.3.5.4.3 Open tread and protection beneath.** Where practical, treads should be open and metal screens or kick plates should be fastened to the underside to avoid injuries from dropped articles.
- **9.3.5.4.4 Stair design for load carrying.** When people are going to carry loads of more than 9 kg (20 lb) or where stairs are more than two stories high, deep treads, 300 mm (12 in), and low risers 125 mm (5 in) should be used.

**Note.** The following criteria are suggested by Building Officials and Code Administrators (BOCA): minimum tread depth, 280 mm (11 in); minimum riser height, 100 mm (4 in); and maximum riser height, 180 mm (7 in). 29 CFR 1910.23 (e)(6) requires a minimum hand clearance of 75 mm (3 in). Stair railings (hand railings) are a minimum of 76 cm (30 in) and a maximum of 86 cm (34 in) above the leading edge of step treads. 29 CFR

**Exhibit 9.3.5.4.1** Design requirements for stair dimensions



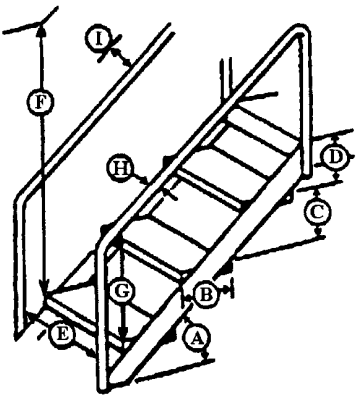
	Min.	Max.	Best
A Angle of rise	30	50	-
B Tread depth	24 cm (9.5 in)	30 cm (12 in)	28-30 cm (11-12 in)
C Riser height	13 cm (5 in)	20 cm (8 in)	17-18 cm (6.5-7 in)
D Depth of nosing	2 cm (.75 in)	4 cm (1.5 in)	3 cm (1 in)
E Width (handrail to handrail)			
One-way stairs	56 cm (22 in)	- -	56 cm (22 in)
Two-way stairs	122 cm (48 in)	- -	130 cm (51 in)
F Minimum overhead clearance	2.1 m (7 ft)	- -	2.1 m (7 ft)
G Height of handrail	76 cm (30 in)	86 cm (34 in)	84 cm (33 in)
H Diameter of handrail	4 cm (1.5 in)	8 cm (3 in)	4 cm (1.5 in)
I Hand clearance	8 cm (3 in)	- -	8 cm (3 in)

1910.24 (d) requires that a fixed stairs be a minimum stair rail (handrail) to stair rail distance of 56 cm (22 in) and have a minimum overhead clearance of 2.1 m (7 ft).

### 9.3.5.5 Stair ladders

- 9.3.5.5.1 Dimensions for stair ladders.** Dimensions for stair ladders are given in exhibit 9.3.5.5.1. If feasible, stair ladder dimensions shall conform with the recommended best values in the exhibit. In all cases, stair ladder dimensions shall be within the minimum and maximum values.

**Exhibit 9.3.5.5.1** Design requirements for stair ladder dimensions



	Min.	Max.	Best
A Angle of rise	50°	75°	-
B Tread depth for 127 cm (50 in) rise	15 cm (6 in)	25 cm (10 in)	22 cm (8.5 in)
for 191 cm (75 in) rise	8 cm (3 in)	14 cm (5.5 in)	10 cm (4 in)
C Riser height	18 cm (7 in)	30 cm (12 in)	20-23 cm (8-9 in)
D Height, step to landing	15 cm (6 in)	riser riser	riser riser
E Width (handrail to handrail)	56 cm (22 in)	61 cm (24 in)	56 cm (22 in)
F Minimum overhead clearance	173 cm (68 in)	- -	193 cm (76 in)
G Height of handrail	86 cm (34 in)	86 cm (34 in)	86 cm (34 in)
H Diameter of handrail	4 cm (1.5 in)	8 cm (3 in)	4 cm (1.5 in)
I Minimum hand clearance	8 cm (3 in)	- -	8 cm (3 in)

**Note.** OSHA 29 CFR 1910.28 requires a standard stair railing and not a handrail if the fall distance is greater

than 1.2 m (48 in). Also, exhibit 9.3.5.5.1 shows a drawing of open stairs where OSHA requires stairs to be closed.

- **9.3.5.5.2 Two way traffic with stair ladders.** Stair ladders are intended for one person at a time either coming up or down. If simultaneous two way traffic is desired, separate up and down ladders should be provided. These stair ladders should be located side by side with double center handrails. There should be a minimum separation of 150 mm (6 in) between these rails. A 200 mm (8 in) separation between the handrails is preferred.
- **9.3.5.5.3 Open treads and protection.** Treads should be open (without risers boards) and should have screens or kick plates fastened to the underside to prevent injury to personnel or damage to equipment if objects are dropped.

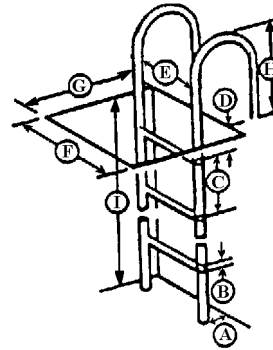
### 9.3.5.6 Fixed ladders

- **9.3.5.6.1 Dimensions for fixed ladders.** Dimensions for fixed ladders are given in exhibit 9.3.5.6.1. If feasible, fixed ladder dimensions shall conform to the recommended best values in the exhibit. In all cases, dimensions shall be within the minimum and maximum values.

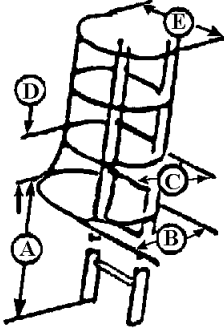
**Note.** OSHA 29 CFR 1910.27 recommends a maximum rung spacing of 305 cm (12 in) and recommends a minimum clearance of back of the ladder of 18 cm (7 in). OSHA 29 CFR 1910.27 covers many more varieties and dimensions for fixed ladders.

- **9.3.5.6.2 Guarded landings, entrances, and cages.** If fixed ladders are used between several floors, the landings and entrances should be guarded, especially if the ladder well is open. Cages or ladder safety devices should be provided for fixed ladders over 6.1 m (20 ft) long. Cage dimensions should be as shown in exhibit 9.3.5.6.2. The inside of the cage must be free of all obstructions. For all fixed ladders over 6.1 m (20 ft), safety devices should be provided to offer positive protection from falls. OSHA 29 CFR 1910.27 offers dimensional information for a variety of caged ladders.

**Exhibit 9.3.5.6.1** Design requirements for fixed ladders



	Min.	Max.	Best
A Angle of rise	60°	90°	75-90°
B Rung or cleat diameter			
wood	3 cm (1.13 in)	4 cm (1.5 in)	4 cm (1.5 in)
protected metal	2 cm (.75 in)	4 cm (1.5 in)	4 cm (1.5 in)
metal that may rust	3 cm (1 in)	4 cm (1.5 in)	4 cm (1.5 in)
C Rung spacing	23 cm (9 in)	30 cm (12 in)	28-30 cm (11-12 in)
D Height, rung to landing	15 cm (6 in)	30 cm (12 in)	28-30 cm (11-12 in)
E Width between stringers	30 cm (12 in)	-	46-53 cm (18-21 in)
F Climbing clearance width	76 cm (30 in)	-	-
G Minimum clearance depth			
in back of ladder	18 cm (7 in)	-	20 cm (8 in)
on climbing side	91 cm for 76° (36 in for 76°)		
	76 cm for 90° (30 in for 90°)		
H Height of string above landing	-	-	91 cm (36 in)
I Maximum height of climb	-	3 m (10 ft)	2.4 m (8 ft)

**Exhibit 9.3.5.6.2** Design requirements for fixed ladder cage dimensions


The diagram shows a side view of a fixed ladder cage. Dimension A is the height from the base of the ladder to the top of the cage. Dimension B is the flare at the bottom of the cage. Dimension C is the depth of the cage from the center of the ladder. Dimension D is the distance between the cage ribs. Dimension E is the width of the cage.

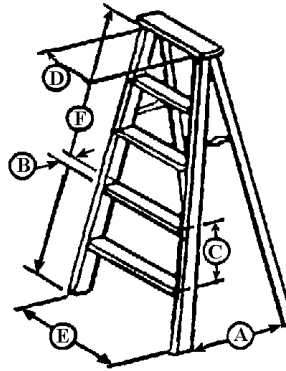
	Min	Max
A Height of cage from base of ladder	213 cm (84 in)	244 cm (96 in)
B Flare at bottom of the cage		"C" + 10.1 cm ("C" + 4 in)
C Depth of cage from center of ladder	69 cm (27 in)	71 cm (28 in)
D Distance between cage ribs	- -	46 cm (18 in)
E Width of cage	69 cm (27 in)	71 cm (28 in)

- **9.3.5.6.3 Rungs versus level steps.** Rungs provide better hand holds, but level steps 75 to 100 mm (3 - 4 in) wide should be used if handrails are provided on both sides of the ladder. All rungs should have nonskid surfaces.
- **9.3.5.6.4 Tread and tread rise.** Tread rise should be open in the rear. The surface of treads on exterior stair ladders should be constructed of open grating material or should be treated with nonskid material (see paragraph 9.3.3.3.1 criteria related to nonskid materials).

### 9.3.5.7 Portable ladders

- **9.3.5.7.1 Dimensions for portable ladders.** Dimensions for portable ladders are given in exhibits 9.3.5.7.1 (a) for step ladders and exhibit 9.3.5.7.1 (b) for portable rung ladders. If feasible, portable ladder dimensions shall conform to the recommended best values in the exhibit. In all cases, dimensions shall be within the minimum and maximum values. OSHA 9 CFR 1910.25-26 provides guidance on the design and use of ladders.

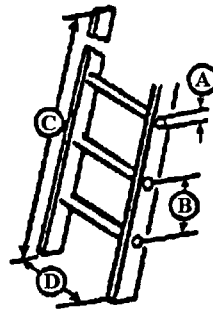
**Exhibit 9.3.5.7.1 (a)** Design requirements for portable step ladders



A Spread	9 cm (3.5 in) per 30 cm (12 in) length of front section plus 5 cm (2 in) per 30 cm (12 in) length of back section
B Tread width	minimum: 8 cm (3 in) best: 8-10 cm (3-4 in)
C Step spacing	wood: minimum: 23 cm (9 in) maximum: 30 cm (12 in)  metal: actual: 30 cm (12 in)
D Width between side rails at top step	wood ladders: 29 cm (11.5 in) * metal ladders: 30 cm (12 in) **
E Width at bottom	add 3 cm (1 in) per foot of length
F Length of ladder	maximum: 6.1 m (20 ft)

\* 29 CFR 1910.26 (a)(i-iii)

\*\* 29 CFR 1910.25 (c)

**Exhibit 9.3.5.7.1 (b) Design requirements for portable rung ladders**

	Min	Max	Best
A Rung diameter			
wood	3 cm (1.13 in)	4 cm (1.5 in)	4 cm (1.4 in)
protected metal	2 cm (0.75 in)	4 cm (1.5 in)	4 cm (1.4 in)
metal that may rust	3 cm (1.0 in)	4 cm (1.5 in)	4 cm (1.4 in)
B Rung spacing	30 cm (12 in)	30 cm (12 in)	30 cm (12 in)
C Maximum ladder length			
single section ladder		9.1 m (30 ft)	
two-section metal ladder		14.6 m (48 ft)	
over two-section wood ladder		18.3 m (60 ft)	
D Minimum width between side rails			
metal ladders		30 cm (12 in)	
wood ladders			
up to 3.0 m (10 ft)		29 cm (11.5 in)	
add .64 cm (.25 in)			
for each added 61 cm (24 in) of length			

- **9.3.5.7.2 Lifting ladders.** Where one person is to lift ladders and store them by hand, ladder weights shall not exceed 9.0 kg (20 lb) for a lift distance of 1.83 m (6 ft) or 11.3 kg (25 lb) for a lift distance of 1.52 m (5 ft.).
- **9.3.5.7.3 Ladder hinges and locks.** Permanent hinges and locks should be used in preference to bolts and nuts for assembly of two-section extension ladders.
- **9.3.5.7.4 Weather implications for portable ladders.** Ladders should be provided with rubber-cleated, pivoted feet for use in nonfreezing weather, and steel cleats for use in ice and snow.



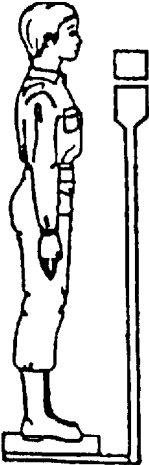
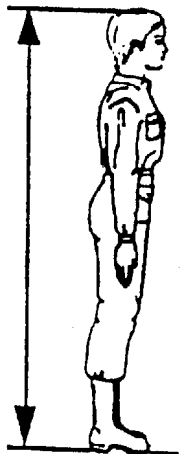
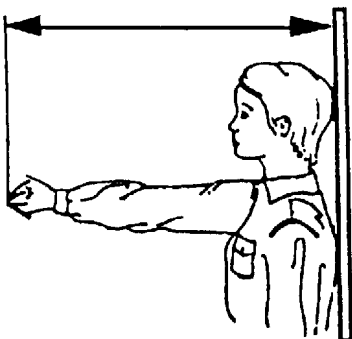
**Note.** 29 CFR 1910.26-29 treats additional details for design and use of a variety of ladders and scaffolding.

## 9.4 Common working positions

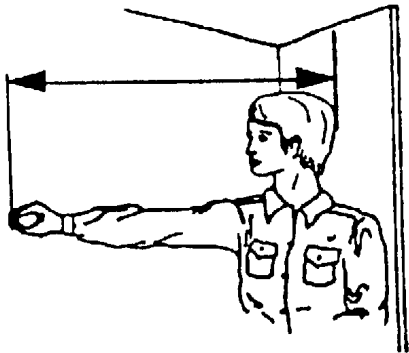
To size and design workplaces, designers draw upon anthropometric information about the population of users. Data for design use representing common working positions and mobile working positions are found in this section. These data supplement the fundamental anthropometric data found in section 14.

- **9.4.1 Static dimensions for common body positions.** Static body positions along with 5th and 95th percentile criteria are given in exhibit 9.4.1. Suitable allowances shall be made for heavy clothing or protective equipment when applicable. Clearance dimensions shall not be less than that for the 95th percentile male; nor shall limiting dimensions be greater than the dimensions for the 5th percentile female.

Exhibit 9.4.1 Anthropometric data for common working positions

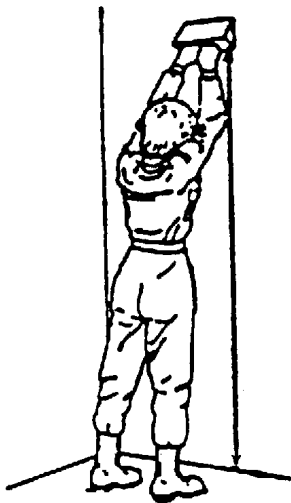
	<p>A. Weight (clothed) wearing fatigues and combat boots; standing in center of scale.</p>			
	<p>5th percentile</p>		<p>95th percentile</p>	
	Male	Female	Male	Female
Weight (kg)	58.6	48.8	90.2	74.6
(lb)	129.1	107.6	198.8	164.5
	<p>B. Stature (clothed) standing erect; heels together; weight distributed equally on both feet; measured from standing surface to top of head.</p>			
	<p>5th percentile</p>		<p>95th percentile</p>	
	Male	Female	Male	Female
Stature (cm)	168.5	156.8	189.0	178.7
(in)	66.4	61.8	74.4	70.3
	<p>C. Functional reach- standing erect; looking straight ahead; both shoulders against wall; right arm horizontal measured from wall to tip of index finger.</p>			
	<p>5th percentile</p>		<p>95th percentile</p>	
	Male	Female	Male	Female
Functional reach (cm)	72.6	64.0	86.4	79.0
(in)	28.6	25.2	34.0	31.1

**Exhibit 9.4.1 (continued) Anthropometric data for common working positions**



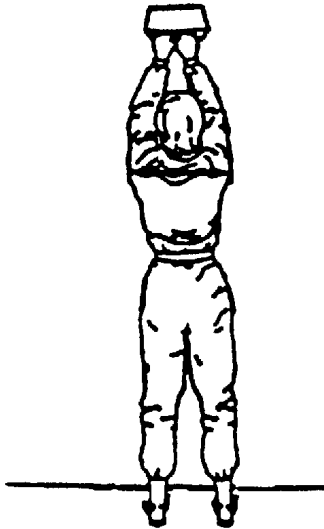
D. Functional reach, extended- standing erect; looking straight ahead; right shoulder extended as far forward as possible while back of left shoulder firmly against wall; arm horizontal measured from wall to tip of index finger.

	5th percentile		95th percentile	
	Male	Female	Male	Female
Functional reach(cm)	84.2	73.5	101.2	92.7
extended (in)	33.2	28.9	39.8	36.5



E. Overhead reach height- standing with heels 23 cm (9 in) apart and toes 15 cm (6 in) from wall; arms extended overhead with fists touching and against wall; 1st phalanges horizontal measured from floor to highest point on 1st phalanges.

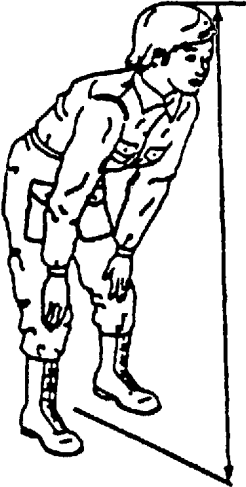


	5th percentile		95th percentile	
	Male	Female	Male	Female
Overhead reach(cm)	200.4	185.3	230.5	215.1
height (in)	78.9	73.0	90.8	84.7



F. Overhead reach breadth- standing with heels 23 cm (9 in) apart and toes 15 cm (6 in) from wall; arms extended overhead with fists touching and against wall; 1st phalanges horizontal measured horizontally across arms or shoulders, whichever is wider.

	5th percentile		95th percentile	
	Male	Female	Male	Female
Overhead reach (cm)	35.2	31.5	41.9	37.9
breadth (in)	13.9	12.4	16.5	14.9

Exhibit 9.4.1 (continued) Anthropometric data for common working positions

	<p>G. Bent torso height- standing with feet 30 cm (12in) apart; bending over and placing palms of the hands on kneecaps; elbows and knees locked; looking forward; head tilted as far back as possible; measured from floor to top of head.</p>			
	5th percentile		95th percentile	
	Male	Female	Male	Female
Bent torso height (cm)	125.6	112.7	149.9	138.6
(in)	49.4	44.4	59.0	54.6
	<p>H. Bent torso breadth- standing with feet 30 cm (12 in) apart; bending over and placing the palms of the hands on kneecaps; elbows and knees locked; looking forward; head tilted as far back as possible; measured as maximum horizontal distance across shoulders.</p>			
	5th percentile		95th percentile	
	Male	Female	Male	Female
Bent torso breadth (cm)	40.9	36.8	48.3	43.5
(in)	16.1	14.5	19.0	17.1
	<p>I. Overhead reach, sitting- sitting erect; right side against wall; right arm extended upward with palm flat against wall and fingers extended; measured from sitting surface to tip of middle finger.</p>			
	5th percentile		95th percentile	
	Male	Female	Male	Female
Overhead reach sitting (cm)	127.9	117.4	146.9	139.4
(in)	50.3	46.2	57.9	54.9

**Exhibit 9.4.1 (continued) Anthropometric data for common working positions**

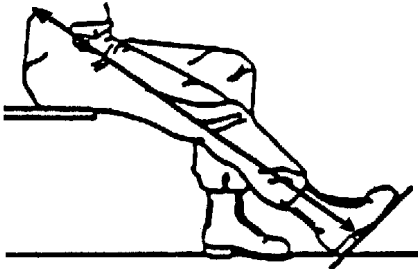
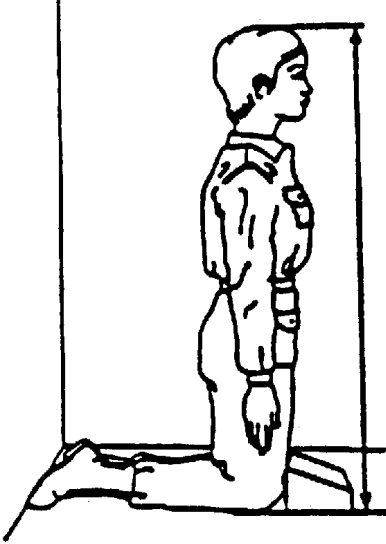
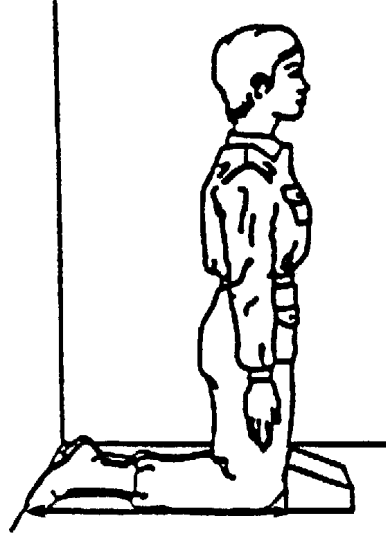
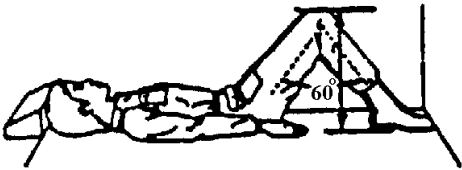
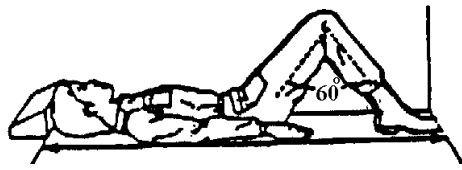
	<p><b>J. Function leg length- sitting erect on edge of chair; right leg extended forward with knee straightened; measured from heel along axis of leg to posterior waist.</b></p>			
	<p style="text-align: center;"><b>5th percentile</b></p> <hr/> <p style="text-align: center;"><b>Male    Female</b></p>		<p style="text-align: center;"><b>95th percentile</b></p> <hr/> <p style="text-align: center;"><b>Male    Female</b></p>	
<p>Functional leg length (cm)</p> <p style="padding-left: 100px;">(in)</p>	<p>110.6</p> <p>43.5</p>	<p>90.6</p> <p>35.7</p>	<p>127.7</p> <p>50.3</p>	<p>118.6</p> <p>46.7</p>
	<p><b>K. Kneeling height- kneeling with toes extended and lightly touching rear wall; torso erect with arms hanging loosely at sides; measured from floor to top of head.</b></p>			
	<p style="text-align: center;"><b>5th percentile</b></p> <hr/> <p style="text-align: center;"><b>Male    Female</b></p>		<p style="text-align: center;"><b>95th percentile</b></p> <hr/> <p style="text-align: center;"><b>Male    Female</b></p>	
<p>Kneeling height (cm)</p> <p style="padding-left: 100px;">(in)</p>	<p>121.9</p> <p>48.0</p>	<p>114.5</p> <p>45.1</p>	<p>136.9</p> <p>53.9</p>	<p>130.3</p> <p>51.3</p>
	<p><b>L. Kneeling leg length- kneeling with toes extended and lightly touching rear wall; torso erect with arms hanging loosely at sides; measured from wall to anterior portion of both knees.</b></p>			
	<p style="text-align: center;"><b>5th percentile</b></p> <hr/> <p style="text-align: center;"><b>Male    Female</b></p>		<p style="text-align: center;"><b>95th percentile</b></p> <hr/> <p style="text-align: center;"><b>Male    Female</b></p>	
<p>Kneeling leg length (cm)</p> <p style="padding-left: 100px;">(in)</p>	<p>63.9</p> <p>25.2</p>	<p>59.2</p> <p>23.3</p>	<p>75.5</p> <p>29.7</p>	<p>70.5</p> <p>27.8</p>

Exhibit 9.4.1 (continued) Anthropometric data for common working positions

	<p><b>M. Bent knee height, supine- lying supine; knees raised until the angle between upper and lower legs approximates 60°; toes lightly touching wall; measured from floor to highest point on knees.</b></p>			
	5th percentile		95th percentile	
	<b>Male</b>	<b>Female</b>	<b>Male</b>	<b>Female</b>
Bent knee height	(cm) 44.7	41.3	53.5	49.6
	(in) 17.6	16.3	21.1	19.5
	<p><b>N. Horizontal length, knees bent- lying supine; knees raised until the angle between upper and lower legs approximates 60°; toes lightly touching wall; measured from wall to top of head.</b></p>			
	5th percentile		95th percentile	
	<b>Male</b>	<b>Female</b>	<b>Male</b>	<b>Female</b>
Horizontal length knees bent	(cm) 150.8	140.3	173.0	163.8
	(in) 59.4	55.2	68.1	64.5

**9.4.2 Mobility in work space**

Maintenance work requiring unusual working positions is to be avoided through design. Dimensions for mobile work space are illustrated in this section.

- **9.4.2.1 Mobile work space approval.** Because of space limitations and under unusual design constraints, personnel may have to perform tasks where they can neither sit nor stand. In order to minimize the cases where such positions are necessary, the rationale and design impacts of all such maintenance tasks shall be submitted to and approved by the acquisition program office prior to detailed design.
- **9.4.2.2 Mobile work space dimensions.** If personnel must work in or pass through such limited spaces, the clearances shall conform with the preferred values, if feasible. In all cases, clearances shall meet or exceed the minimum values given and illustrated in exhibit 9.4.2.2.

Exhibit 9.4.2.2 Seated workspace dimensions and illustrations

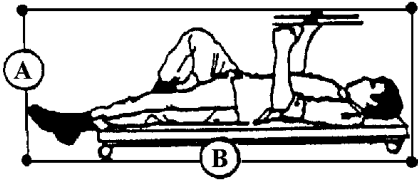
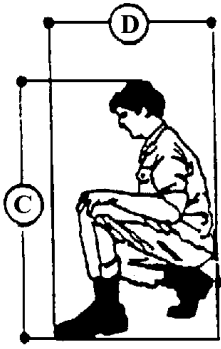

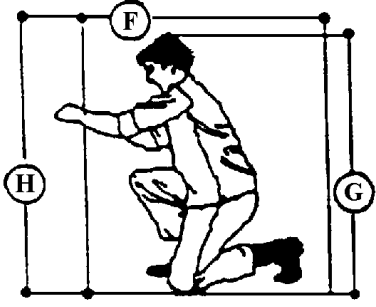
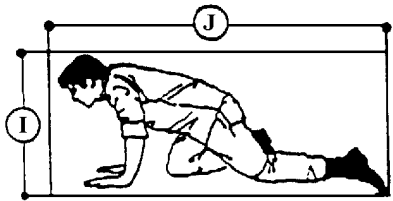
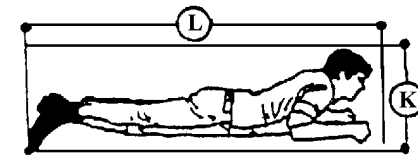
		Minimum	Preferred	Arctic clothed	
		<b>Supine workspace</b>			
A. Height	(mm) (in)	510 20	610 24	660 26	
B. Length	(mm) (in)	1860 73	1910 75	1980 78	
		<b>Squatting workspace</b>			
C. Height	(mm) (in)	1220 48	- -	1290 51	
D. Width	(mm) (in)	685 27	910 36	- -	
	Optimum display area	(mm) (in)	685 27	1090 43	- -
	Optimum control area	(mm) (in)	485 19	865 34	- -
		<b>Stooping workspace</b>			
E. Width	(mm) (in)	660 26	1020 40	1120 44	
	Optimum display area	(mm) (in)	810 32	1220 48	- -
	Optimum control area	(mm) (in)	610 24	990 39	- -
		<b>Kneeling workspace</b>			
F. Width	(mm) (in)	1060 42	1220 48	1270 50	
G. Height	(mm) (in)	1420 56	- -	1500 59	
H. Optimum work point	(mm) (in)	- -	685 27	- -	
	Optimum display area	(mm) (in)	510 20	890 35	- -
	Optimum control area	(mm) (in)	510 20	890 35	- -

Exhibit 9.4.2.2 (continued) Mobile work space dimensions and illustrations

		Minimum	Preferred	Arctic clothed
		<b>Kneeling crawl space</b>		
I. Height	(mm) (in)	785 31	910 36	965 38
J. Length	(mm) (in)	1500 59	- -	1760 69
		<b>Prone work or crawl space</b>		
K. Height	(mm) (in)	430 17	510 20	610 24
L. Length	(mm) (in)	2860 113	- -	- -

### 9.4.3 Standing workplaces

Standing workplaces are used for routine, frequent, or short term jobs or tasks for which the worker needs to be able to face different directions, or to move from one position to another. The designer can exploit the following advantages of a standing position when they are compatible with the maintenance tasks to be performed:

- When standing, maintainers can apply more muscular arm force and make larger arm movements than when seated. These forces may be applied to levers or valves.
- Standing workers can move to see and use components in areas that would be inaccessible to seated users.
- Standing workers can move about to reduce fatigue and boredom.
- Standing workers can use flat working surfaces, without knee room, thus saving space.
- A standing workplace is not as dimensionally constrained as that of the seated operator. Equipment that standing operators view or adjust may be placed anywhere around them as long as it is at the proper height.

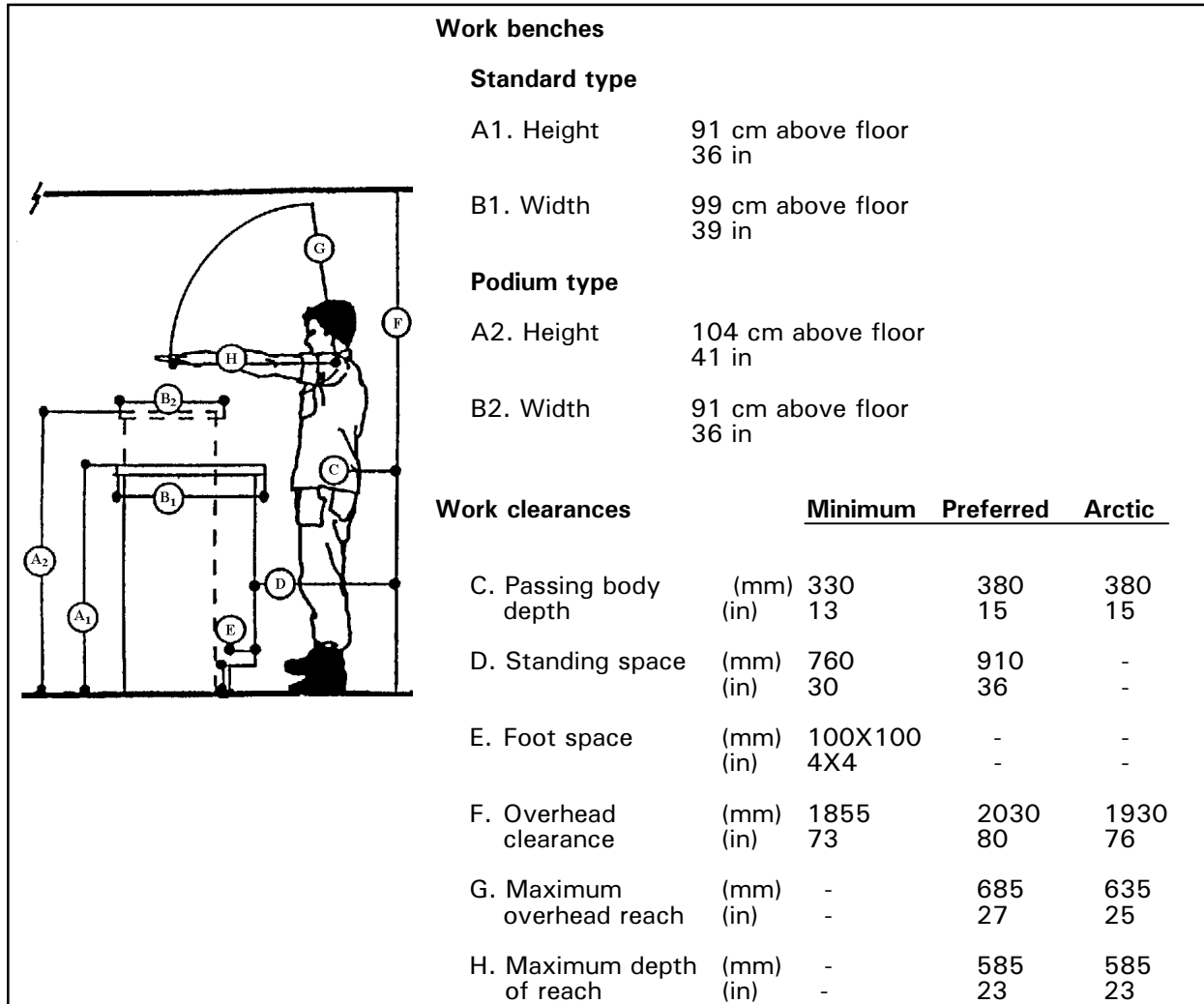
**Discussion.** If the worker is not free to move about, or if the task and attention demands are concentrated so that the worker remains in one position, the workstation should be designed so the worker can sit or take a sit-stand position. The main disadvantage of the standing position is that the worker's physical workload is increased because one constantly has to carry one's own weight and stabilize and balance one's body.

- **9.4.3.1 Standing workplace and workbench dimensions.** The dimensions of standing workplaces and workbenches should conform to the preferred values in exhibit 9.4.3.1. In all cases,



the dimensions should meet the minimum and not exceed the maximum values in the exhibit. When required by the task or when practical, the preferred dimensions should provide for adjustments to accommodate the 5th through the 95th percentile of the worker population (see section 14.3).

**Exhibit 9.4.3.1** Standing workplace illustration and dimensions



### 9.4.4 Seated workplaces

In this section, a discussion to help exploit the advantages of the seated position is followed by general guidelines for ensuring seating compatibility with tasks. The section includes guidelines for office seating design, and for seat cushion, armrest, and footrest design. Temporary swing away seats are also treated. For seating associated with Visual Display Terminals, see section 9.6. Vehicles and moving platform seats are not addressed in this document.

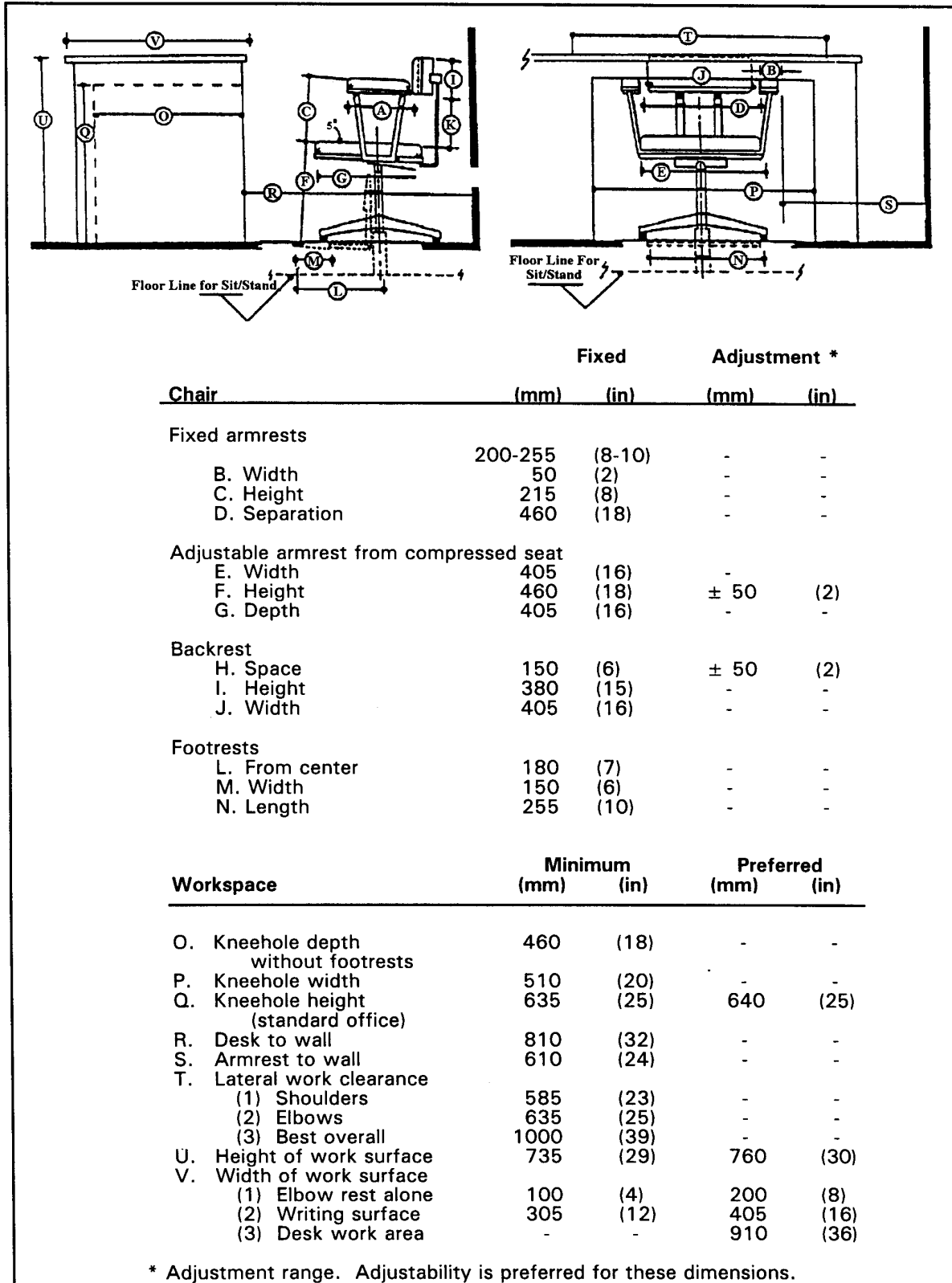
Designers can exploit the following advantages of seated positions:

- a. Seated positions reduce workload by helping maintain the body position and carry body weight.
- b. Seats provide comfortable positions that promote long-term focused attention on activities and information in the nearby workspace.
- c. Seating can help establish stability to accommodate fine eye-hand coordination tasks.
- d. Seating can be designed to accommodate powerful exertions on pedals.
- e. Seating limits reach with both arms and hands.
- f. Seating can be designed to swivel and move on rollers to extend visual, reach, and communications access.

The main disadvantages of seated work positions are that seated workers can apply less arm force and smaller arm movements than standing workers. In addition, seated workers have more accessibility to equipment and are able to move about to reduce fatigue and boredom.

- **9.4.4.1 Seated workplace guideline.** Workplace seats should provide support for and stabilize the worker's body. The seat should permit visual, reach, and communications access so the intended work tasks can be performed efficiently and without interference. Neither the shape of the seat nor the materials used in the seat should prevent the worker from adjusting body position in the seat for task activities or for comfort.
- **9.4.4.2 Seat compatibility.** Seats should be compatible with the work tables, benches, desks, consoles, equipment, tools, controls, and displays that are necessary to the tasks.
- **9.4.4.3 Swivels and rollers.** For most jobs and tasks that do not require heavy work and where seated positions are appropriate, swivel capability and caster rollers are desirable for seat ingress and egress and task performance throughout the workplace.
- **9.4.4.4 Seating dimensions.** General seated workplace dimensions are given and illustrated in exhibit 9.4.4.4. Seat designs and selections should meet or exceed minimum values, should provide adjustment ranges, and should provide fixed and preferred values when these are compatible with the population and tasks to be performed.

Exhibit 9.4.4.4 Seated workspace dimensions and illustrations



- **9.4.4.5. Knee space.** The preferred knee space, as shown in exhibit 9.4.4.4, should be 640 mm (25 in) in height. Where equipment packaging permits, knee space and associated leg space should be attained by sloping the console surface under the working or writing surface. A footrest will increase the needed knee space.
- **9.4.4.6 Seat cushioning.** Seats should be cushioned whenever workers must remain seated for more than an hour at a time, or for more than 20% of their working time. Good seat cushioning should:
  - a. have flat, firm shape with enough softness to deform,
  - b. have resilient material under the cushion to absorb shocks,
  - c. support body weight, primarily around the two bony points of the pelvis,
  - d. tilt backward 5-7 degrees so the seat (rather than the user's muscles) supports the back,
  - e. be shaped to follow the inward curve of the lower back, and provide adequate support for it, to relieve strain of the back muscles,
  - f. avoid applying pressure under the thighs,
  - g. incorporate perforated or ventilated materials, to prevent hotness or sweating, and
  - h. allow the sitter to shift positions.

**Discussion.** Larger cushioned backrests are best because a larger support area provides the user more opportunities to change position.

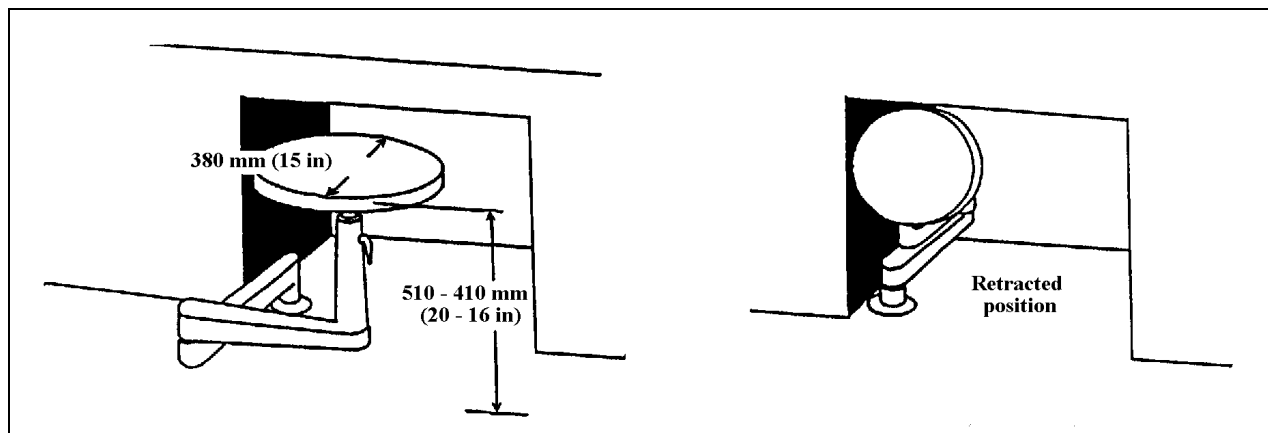
- **9.4.4.7 The use of armrests.** Workplace seating should provide armrests so that the elbows can support some upper body weight, unless the rests would be incompatible with the tasks. Armrests should be undercut to allow space for the hips and thighs. Exhibit 9.4.4.4 provides fixed armrest dimensions. Removable or adjustable armrests should be considered when removal is necessary for some primary tasks. The preferred adjustable range is from 190 to 280 mm (7.5 to 11 in) above the compressed seat surface. They should be at least 200 mm (8 in) in length. When seated tasks include the use of a tracking control for frequent or continuous control, the armrest should support the worker's arm in the same plane as the control.
- **9.4.4.8 Uncushioned stools and benches.** Uncushioned stools or work benches are adequate for intermittent sitting, but they should conform to applicable criteria for seats.

- **9.4.4.9 Footrests.** Whenever workers must sit for extended sitting periods in seats higher than 460 mm (18 in) or work with work surfaces higher than 760 mm (30 in), they should have a footrest which may be designed into the chair or stool. When footrests are separate items, they should not be allowed to interfere with traffic.

**Explanation.** Footrests may also be separate items positioned on the floor where they provide support and add to comfort for seated jobs. Footrests should not be allowed to interfere with traffic areas.

- **9.4.4.10 Temporary seats.** Where space limitations and task frequency warrant, a temporary swing away seat should be provided. Exhibit 9.4.4.10 illustrates a swing away seat. The preferred seat diameter should be 380 mm (15 in), and the floor to seat top dimension should be 460 mm (18 in) with an adjustability of plus or minus 50 mm (2 in).

**Exhibit 9.4.4.10** Swing-away seat for short term use



## 9.5 Standard console design

Standard console designs are addressed in this section. Recommended configurations for sit, sit-stand, and stand consoles are given, and horizontal wrap-around and vertically stacked segment alternatives are provided. Additional consoles for teams that monitor ongoing processes are addressed in this section.

### 9.5.1 Sit, sit-stand, and stand consoles

The guidelines that follow are to be used to gain the benefits and potential cost savings inherent in standard consoles, units, and racks. In some cases planned usage may necessitate unique design solutions.

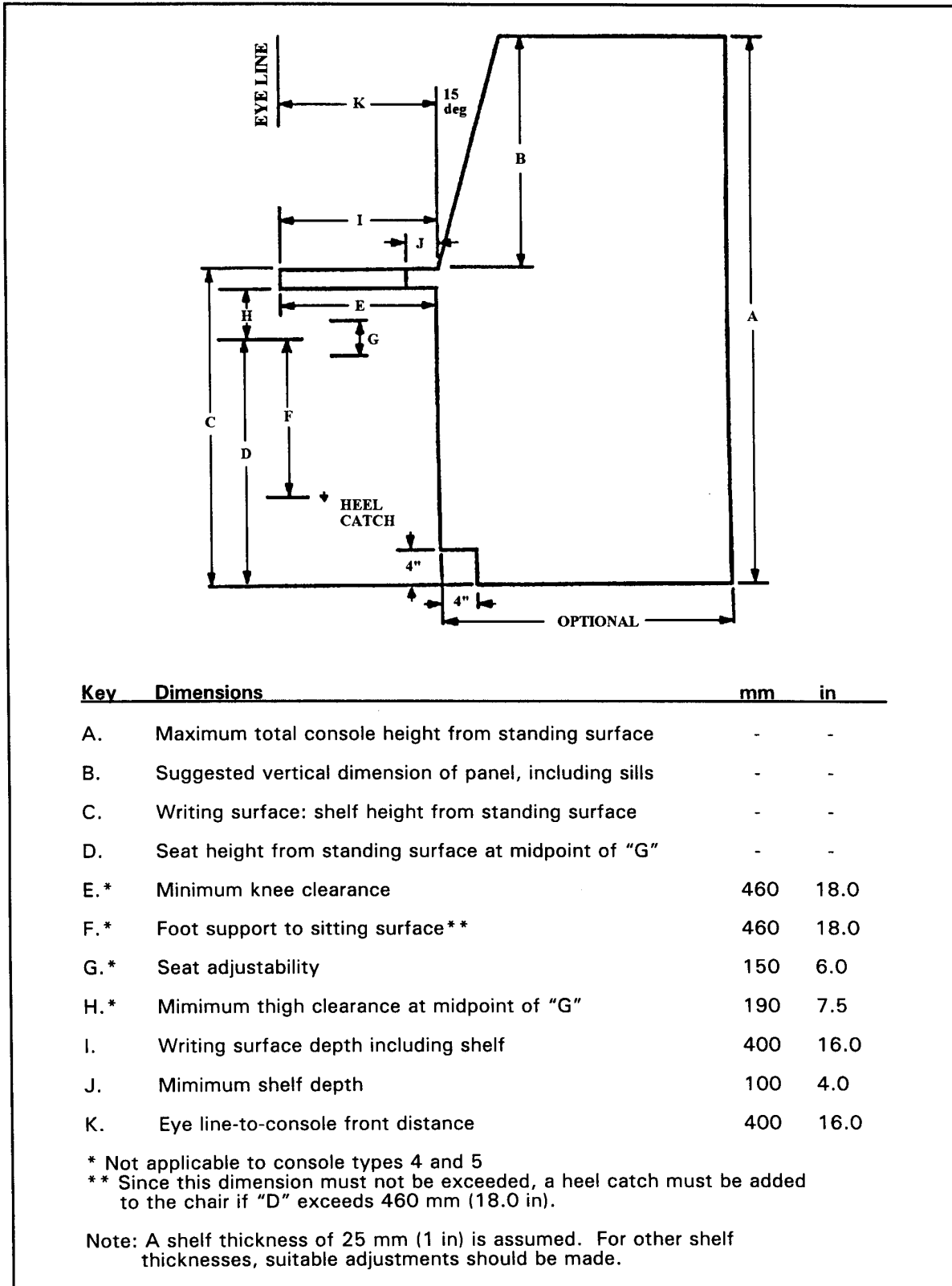
**Discussion.** The maintainer may work with consoles during maintenance monitoring and repair activities. Their task performance is influenced by 1) the contours and slopes of the console panels, 2) the parallax in viewing displays, 3) the location of displays and controls, and 4) the adequacy of the space to support the console operator.

- **9.5.1.1 Dimensions for console configurations.** Exhibit 9.5.1.1 (a) lists five types of consoles for individuals and gives dimensions for alternative standard configurations. Selected configurations should conform to the dimensions listed and illustrated in exhibit 9.5.1.1 (b).

**Exhibit 9.5.1.1 (a)** Standard console dimensions

Type of console	Maximum total console height from standing surface		Suggested vertical dimension of panel (with sills)		Writing surface shelf height from standing surface		Seat height from standing surface at midpoint of G		Maximum console width (not shown)	
	mm	(in)	mm	(in)	mm	(in)	mm	(in)	mm	(in)
	A		B		C		D		-	
1. Sit (with vision over the top)*	1170	(46.0)	520	(20.5)	650	(25.5)	435	(17.0)	1120	(44.0)
	1335	(52.5)	520	(20.5)	810	(32.0)	595	(23.5)	1120	(44.0)
	1435	(56.5)	520	(20.5)	910	(36.0)	695	(27.5)	1120	(44.0)
2. Sit (without vision over top)	1310	(51.5)	660	(26.0)	650	(25.5)	435	(17.0)	910	(36.0)
	1470	(58.0)	660	(26.0)	810	(32.0)	595	(23.5)	910	(36.0)
	1570	(62.0)	660	(26.0)	910	(36.0)	695	(27.5)	910	(36.0)
3. Sit-stand (with standing vision over top)	1535	(60.5)	620	(24.5)	910	(36.0)	695	(27.5)	910	(36.0)
4. Stand (with vision over top)	1535	(60.5)	620	(24.5)	910	(36.0)	NA NA		1120	(44.0)
5. Stand (without vision over top)	1830	(72.0)	910	(36.0)	910	(36.0)	NA NA		910	(36.0)
* The range in "A" is provided to allow latitude in the volume of the lower part of the console; note relationship to "C" and "D."										

Exhibit 9.5.1.1 (b) Standard console illustration and dimensions key



- **9.5.1.2 Selection of a standard console.** Each console configuration should be selected to accommodate the following task-related variables:
  - a. visibility over the top of console,
  - b. user mobility (e.g., sit, sit-stand, or stand requirements),
  - c. control and display demand for panel space (for example, display legibility, control accessibility),
  - d. volume of space necessary for leg room and essential equipment beneath the writing surface, and
  - e. communications demands of the tasks.

### 9.5.2 Horizontal wrap-around console alternatives

Whenever the panel space required for a seated console user exceeds that recommended in exhibit 9.5.1.1 (a), the special purpose horizontal wrap-around console presented in this section may be used. The concept for this alternative is illustrated in exhibit 9.5.2.

- **9.5.2.1. Panel width.** When requirements for preferred panel space for the user exceed a panel width of 1.12 m (44 in), a flat-surface, segmented, wrap-around console should be provided. This panel facilitates placing controls within the reach of the 5th percentile users.
 

- **9.5.2.2 Panel angles.** The left and right segments should be placed at an angle, measured from the frontal plane of the central segment, so that these segments can be reached by the 5th percentile stationary operator.

**Exhibit 9.5.2** Example of horizontal wrap-around console

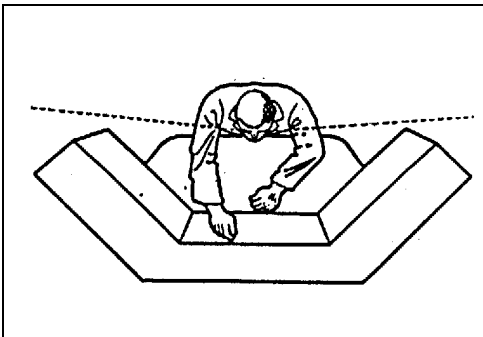

- **9.5.2.3 Dimensions with vision over the top.** Where vision over the top is required (thereby limiting vertical panel space), the width of the central segment shall not exceed 1.12 m (44 in), and that of the left and right segments shall not exceed 610 mm (24 in).
- **9.5.2.4 Width dimensions without vision over the top.** Where vision over the top is not required (that is, where the total console height exceeds the seat height by more than 690 mm (27 in)), the width of the central segment shall not exceed 860 mm (34 in), and that of the left and right segments, if possible, shall not exceed 610 mm (24 in).
- **9.5.2.5 Viewing angle.** The total required left-to-right viewing angle shall not exceed 190 degrees (see head and eye rotation in

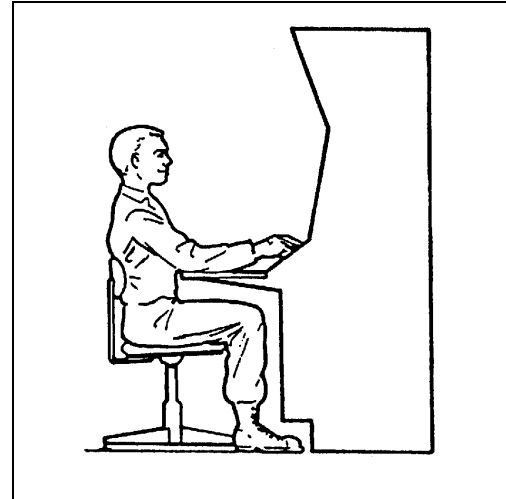


exhibit 7.2.1.6.8). This angle should be reduced whenever possible through appropriate control-display layout.

### 9.5.3 Vertical stacked segments for consoles

Another alternative special-purpose console applies to the case where seeing over the top is not required and lateral space is limited. The concept for this individual seated user console is shown in exhibit 9.5.3.

**Exhibit 9.5.3** Examples of vertical stacked segments



- **9.5.3.1 Panel division.** Where direct forward vision over the top of the console is not required by a seated person and where lateral space is limited, the panel shall be divided into three vertical stacked segments whose surfaces are perpendicular to the operator's line of sight when the head is moved up or down slightly.
- **9.5.3.2 Height.** The center of the central segment should be 800 mm (31.5 in) above the seat reference point. If feasible, the height of this segment shall not exceed 530 mm (21 in).

### 9.5.4 Design and arrangement of multiperson consoles

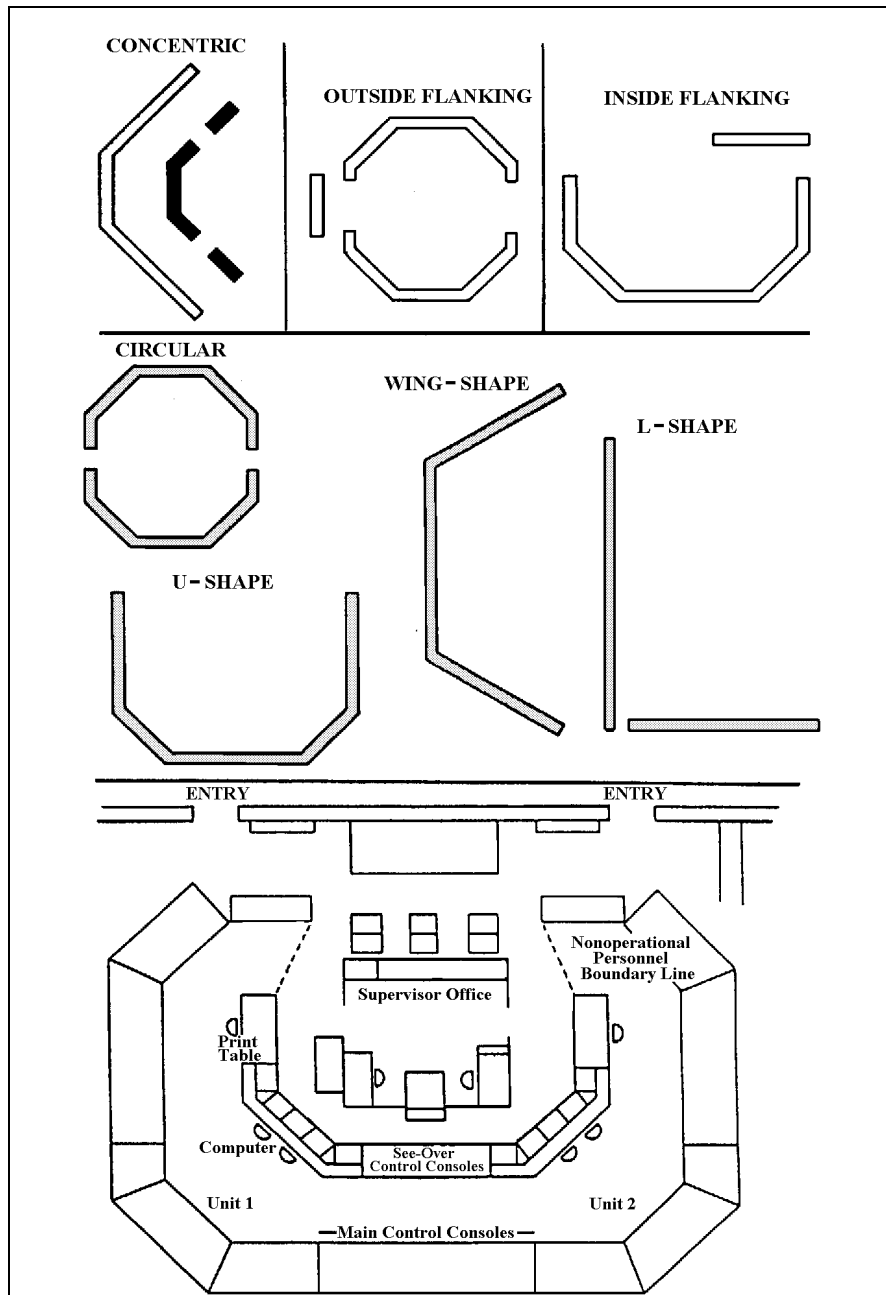
When a team must monitor, diagnosis, or control a large ongoing process or operation, many arrangements of consoles are possible. Exhibit 9.5.4.1 shows several basic console arrangements, variations on the basic arrangements, and an example of a multi-unit control room which incorporates supervisory visual access. This section offers guidelines for selecting among alternative console arrangements and console designs.

- **9.5.4.1 Selecting arrangements for team consoles.** Several primary and support factors shall be used in selecting among alternative team console arrangements (see exhibit 9.5.4.1). When team consoles are appropriate, the rationale, the use of the factors, and their design impacts shall be verified as agreed upon with the acquisition program office. The factors to be used are listed in (a) through (q):

**Discussion.** Primary factors for team console arrangements, (a) through (l), are those that directly involve and impact the ongoing process and mission of the system. Secondary or support factors, (m) through (q), are off-line to the direct process monitoring or control but may influence the layout and design of team consoles.

- a. functions and resultant tasks for personnel, hardware, and software components that are necessary for process

**Exhibit 9.5.4.1** Basic and variations of multiperson console arrangements with an example control room arrangement



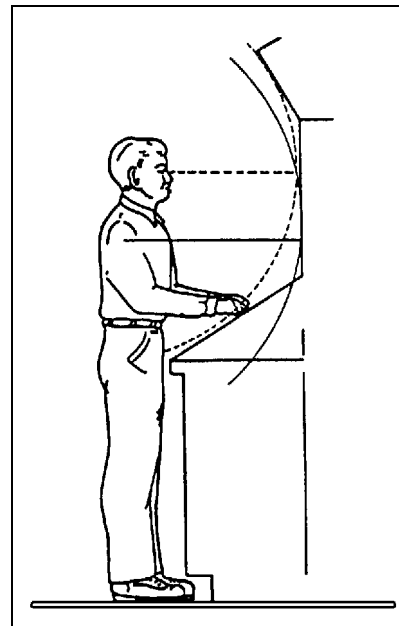
monitoring and controlling (These functions and tasks must cover normal, degraded, and emergency modes of system operations.),

- b. necessary team communication interactions and team links with external command and control components of the system,

- c. numbers of personnel necessary to handle the expected high workload levels,
  - d. common viewing requirements and individual visual access requirements,
  - e. maintenance access for control or processing subsystems,
  - f. supervisory viewing requirements, ongoing supervisory process control responsibilities, supervisory space and access requirements, and supervisory information and communications requirements,
  - g. management, maintenance, and operating concepts and policies,
  - h. architectural and facility engineering constraints,
  - i. requirements and space constraints associated with primary equipment, controls and displays, computer, printout or readout devices, and closed-circuit monitoring devices,
  - j. illumination, acoustic, and environmental requirements associated with primary tasks,
  - k. primary work surface areas for writing and reading,
  - l. primary storage areas and surfaces for documents, procedures, tools, spares, and supplies,
  - m. secondary supervisor office privacy requirements,
  - n. security requirements,
  - o. visitor provisions and traffic areas,
  - p. personnel conveniences such as restrooms, kitchen, snack, drinking water, and personal belonging storage, and
  - q. support storage for additional documentation and other housekeeping needs.
- **9.5.4.2 Selecting team console types and designs.** Many factors should be considered in selecting and designing individual team position consoles. Selection should be made among standard sit, sit-stand, and stand consoles (see section 9.5.1), free standing consoles, built-in vertical wall consoles, and specially configured consoles. Selection should be based upon the factors that follow:
- a. functions and tasks allocated to the types of personnel and position(s) associated with the console,
  - b. visual access required for common control display areas which may determine the required see-over characteristics,

- c. position communication requirements,
- d. personnel mobility requirements,
- e. reach and visual access areas for consoles (exhibit 9.5.4.2 shows reach and visual legibility arcs for console design),

**Exhibit 9.5.4.2** Concepts of functional reach arc and equidistant visual arc for a stand console



**Discussion.** In accomplishing the design layout the designer needs to consider the criticality, durations, and frequency of control and display interactions, as well as the legibility and accuracies required.

- f. work surface area requirements,
  - g. requirements to share information, displays, controls, or work surfaces with adjacent positions,
  - h. the postures required for monitoring and controlling, as well as the durations that such postures must be maintained, and
  - i. the need for consoles and information standardization across system functions and locations to reduce training and to facilitate interoperability.
- **9.5.4.3 Use of position coding.** Process control and monitoring through team consoles should take advantage of the benefits of position coding. Such coding should be compatible with the process flow or representations of the process flow. Such coding and representation consistently position information, displays, and controls for all users.

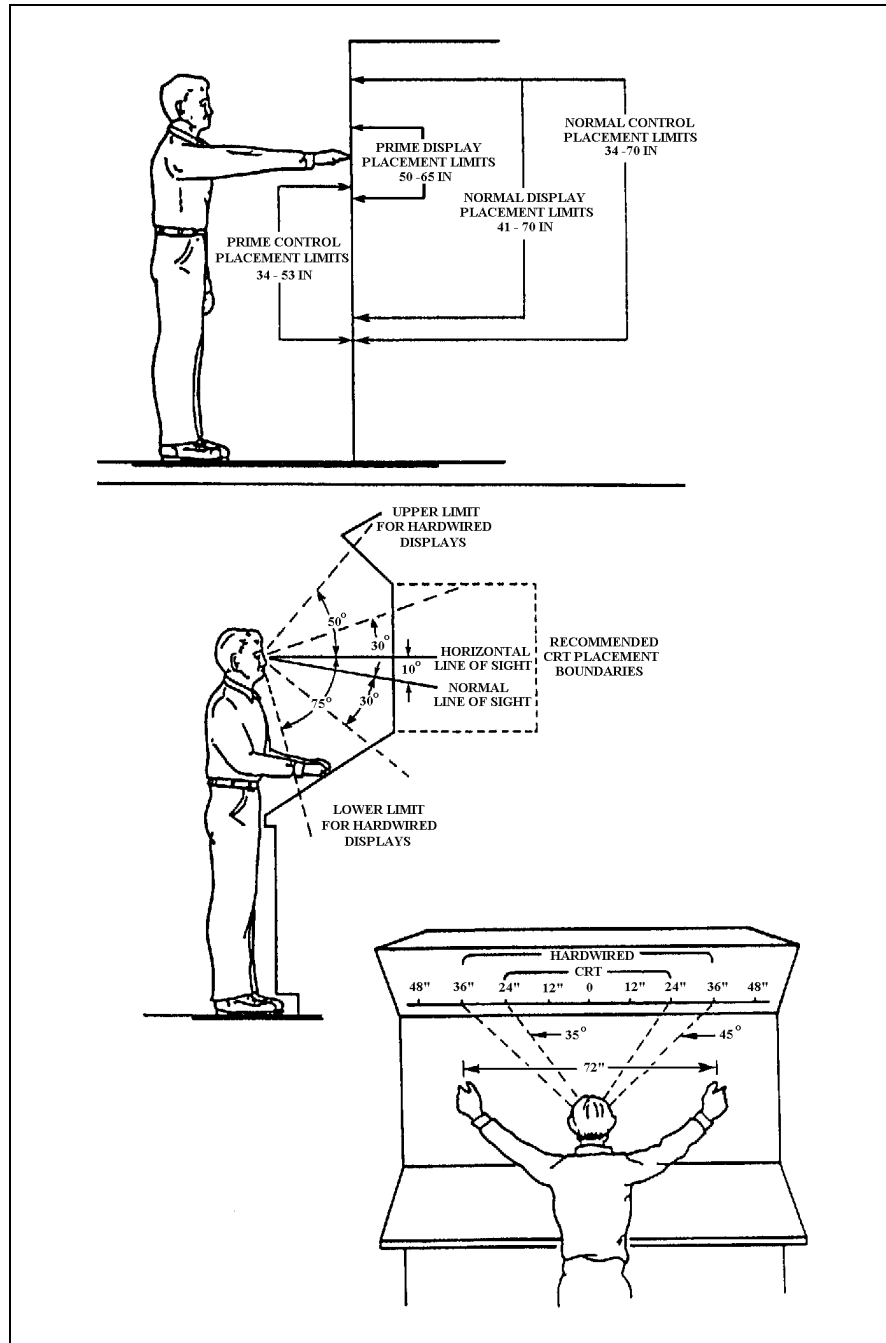
**Definition. Position coding** is the consistent placement of controls, displays, and associated information in the same physical location within identical (or similar) workstations and displays. This powerful coding can lead to beneficial expectations in experienced users and, with appropriate training, similarly can benefit naive or less experienced users.

- **9.5.4.4 Control and display placement on stand consoles.** Exhibit 9.5.4.4 illustrates control and display placement limits for those vertical and stand consoles where see-over capabilities are not required. Prime controls and displays (including CRT displays) should be located in the prime areas and within the boundaries noted in the exhibit. Exhibit 9.5.4.4 indicates that hardwired displays including annunciator displays should be located horizontally within 45 degrees of the operator's eye reference point and CRT displays should be restricted to within 35 degrees. On consoles where a discrete task sequence of display and control actions is appropriate for a single user's actuation, the sequenced displays and controls should not exceed 1.8 m (72 in) in width so reach and visual access can be accommodated.

**Explanation.** The actual display limits on the console will depend upon the distance from which the worker views the console displays. The illustration at the bottom of exhibit 9.5.4.4 shows a 1.8 m (72 in) dimension as the maximum lateral spread for a discrete task at normal viewing distance.

- **9.5.4.5 Special team sit-stand console and work space dimensions.** When a sit-stand console requires a see-over capability, the vertical height of the console should be no higher than 1.40 m (55 in). Where a sit-stand desk surface of at least 410 mm (16 in) deep and 610 mm (24 in) wide is provided, (760 mm, or 30 in, is preferred). Desk height should be 910 to 960 mm (36 to 38 in) high so that the seated eye height can be about the same as the standing eye height. The seat should be adjustable up to 760 mm (30 in) in seat cushion height and should have a 460 mm (18 in) diameter footrest located at a constant 460 mm (18 in) below the seat cushion.

**Exhibit 9.5.4.4** Recommended placement areas for controls and displays on vertical and stand consoles



## 9.6 Visual display terminals

Visual display terminals, keyboard entry devices and associated furniture have become commonplace throughout industrialized workplaces. Scientifically-based standardization information has been compiled by the Human Factors and Ergonomics Society. For the applicable environments, this document defers to and applies that work. The American National Standard Institute

(ANSI) document cited in this section should be obtained from the Human Factors and Ergonomics Society, Inc. (P.O. Box 1369 Santa Monica, CA 90406 U.S.A) which holds the copyright.

- **9.6.1 Visual display terminals, associated furniture, and office environments.** Where a Visual Display Terminal (VDT) is to be used for text processing, data entry, and data inquiry applications in an office environment or equivalent, the Visual Display Terminals and associated keyboard entry devices, the associated furniture, and the environments in which the Visual Display Terminal is placed for use shall conform to the American National Standard for Human Factors Engineering of Visual Display Terminal Workstations, ANSI/HFS 100-1988. Where criteria are not specified by ANSI/HFS 100-1988, the VDT, associated furniture, and environments shall conform to applicable provisions of this document.

## 9.7 Accommodating people with disabilities: accessible elements and space

The Americans with Disabilities Act Handbook provides accessibility "guidelines" to be applied during design, construction, and alteration of buildings and facilities to the extent required by regulations issued by Federal Agencies including the Department of Justice. The present subsection refers to those parts of the Handbook that correspond with the workplace topics of section 9. If acquisitions or modifications include workspace design for jobs that are subject to being filled by Americans with disabilities, the workspace aspects of the handbook apply. To comply with the following rules, human factors professionals refer to the handbook itself to ensure that all relevant topics are applied to specific system or equipment.

- **9.7.1 Accessibility - facilities, passageways, walks, and workplaces.** Developers shall comply with the guidelines found in Appendix B and C of the Americans with Disabilities Act Handbook.

**Discussion.** Appendix B of the Americans with Disabilities Act Handbook sets "guidelines" for accessibility to places of public accommodation and commercial facilities and Appendix C sets Uniform Federal Accessibility Standards for federally-funded facilities to the extent required by the Architectural Barriers Act of 1968 as amended. Material in these documents introduces accessibility terms and includes many of the topics from section 9 of this document. Specifically, the requirements of the following paragraphs of the ADA Accessibility Guidelines (ADAAG) Appendix B for Buildings and Facilities are relevant:

- 4.1.5 Accessible buildings: additions
- 4.1.6 Accessible buildings: alterations
- 4.2 Spacer allowances and reach ranges
- 4.3 Accessible route
- 4.4 Protruding objects
- 4.5 Ground and Floor Surfaces
- 4.8 Ramps

- 4.9 Stairs
- 4.13 Doors
- 4.14 Entrances
- 4.25 Storage
- 4.26 Handrails, Grab Bars, Tubs, Showers
- 4.27 Controls and Operating Mechanisms
- 4.28 Alarms
- 4.29 Detectable Warnings
- 4.30 Signage
- 4.31 Telephones
- 4.42 Fixed or Built-in Seating and Tables

However, the ADA materials cover many more topics and exclusions specific to building and facility types. The user is advised to use the complete ADA Handbook to ensure compliance.

- **9.7.2 Reasonable accommodation of workspace to an individual.** If an individual employee with disabilities is qualified and selected for a job, Title 1 of the ADA requires "reasonable accommodations" of the job and workspace to the individual. Modifications of the workspace to permit maneuvering and reaching controls, shelves, and reference materials should be provided, as necessary.

Appendix A4.1.1, Application, to the ADAAG requires that wherever a series of individual workstations of the same type (for example, laboratories, service counters, ticket booths) at least one or five percent of the work stations should be constructed so that an individual with disabilities can maneuver within the workspace.

- **9.7.3 Office Rooms.** Offices rooms in a typical office setting shall meet the ADA requirements concerning doors, accessible routes and the like, but do not need to allow for ADA maneuvering space around individual desks, except as noted in paragraph 9.7.2.



## Section 10 contents

<b>10 User documentation</b> .....	<b>10-1</b>
<b>10.1 General</b> .....	<b>10-1</b>
<b>10.1.1 Matching documentation to users</b> .....	<b>10-2</b>
▪ 10.1.1.1 Description of expected users .....	10-2
▪ 10.1.1.2 Documentation for people at different skill levels .....	10-2
<b>10.1.2 Making documentation appear easy to use</b> .....	<b>10-2</b>
□ 10.1.2.1 Tabs .....	10-3
□ 10.1.2.2 Guides to organization .....	10-3
□ 10.1.2.3 Table of contents .....	10-3
□ 10.1.2.4 Figures and examples .....	10-3
□ 10.1.2.5 Lists and tables .....	10-3
<b>10.2 Writing user documentation</b> .....	<b>10-3</b>
<b>10.2.1 Organization</b> .....	<b>10-3</b>
<b>10.2.1.1 Titles and headings</b> .....	<b>10-4</b>
▪ 10.2.1.1.1 Titles .....	10-4
▪ 10.2.1.1.2 Paragraph titles .....	10-4
▪ 10.2.1.1.3 Hierarchy .....	10-4
▪ 10.2.1.1.4 Uniqueness of titles .....	10-5
<b>10.2.1.2 Numbering of sections and subsections</b> .....	<b>10-5</b>
□ 10.2.1.2.1 Decimal numbering .....	10-5
□ 10.2.1.2.2 Itemization within a paragraph .....	10-5
□ 10.2.1.2.3 Number of levels .....	10-5
<b>10.2.1.3 Advance organizers</b> .....	<b>10-5</b>
□ 10.2.1.3.1 When to provide advance organizers .....	10-6

<b>10.2.1.4 Internal cross references</b>	.....	<b>10-6</b>
□ 10.2.1.4.1 Minimize internal cross referencing	.....	10-6
■ 10.2.1.4.2 Form of internal cross references	.....	10-6
<b>10.2.1.5 Task versus list orientation</b>	.....	<b>10-6</b>
□ 10.2.1.5.1 Task orientation	.....	10-7
□ 10.2.1.5.2 List orientation	.....	10-7
<b>10.2.2 Paragraphs</b>	.....	<b>10-7</b>
□ 10.2.2.1 Content of paragraphs	.....	10-7
□ 10.2.2.2 Linking sentences	.....	10-7
□ 10.2.2.3 Topic sentences	.....	10-7
□ 10.2.2.4 Length of paragraphs	.....	10-7
<b>10.2.3 Sentences</b>	.....	<b>10-7</b>
<b>10.2.3.1 Choice of wording</b>	.....	<b>10-8</b>
■ 10.2.3.1.1 Clear, simple language	.....	10-8
□ 10.2.3.1.2 Technical terms	.....	10-8
■ 10.2.3.1.3 Nonsexist language	.....	10-8
<b>10.2.3.2 Writing level, readability</b>	.....	<b>10-8</b>
□ 10.2.3.2.1 Writing level	.....	10-8
<b>10.2.3.3 Length</b>	.....	<b>10-8</b>
□ 10.2.3.3.1 Average length	.....	10-8
<b>10.2.3.4 Complexity</b>	.....	<b>10-9</b>
□ 10.2.3.4.1 Single thought	.....	10-9
□ 10.2.3.4.2 Subordinate clauses	.....	10-9
□ 10.2.3.4.3 Conditional sentences	.....	10-9
<b>10.2.3.5 Word order</b>	.....	<b>10-9</b>
□ 10.2.3.5.1 Normal order	.....	10-9
■ 10.2.3.5.2 Chronological	.....	10-9
□ 10.2.3.5.3 Importance	.....	10-9
<b>10.2.3.6 Voice</b>	.....	<b>10-10</b>
□ 10.2.3.6.1 Active, not passive voice	.....	10-10

<b>10.2.3.7 Person and mood</b>	.....	<b>10-10</b>
▪ 10.2.3.7.1 Second person imperative	.....	10-10
▪ 10.2.3.7.2 Third person indicative	.....	10-10
<b>10.2.3.8 Positive, not negative wording</b>	.....	<b>10-10</b>
□ 10.2.3.8.1 When to use positive wording	.....	10-10
□ 10.2.3.8.2 When to use negative wording	.....	10-10
<b>10.2.3.9 Standard phrases</b>	.....	<b>10-11</b>
□ 10.2.3.9.1 Consistent phrases	.....	10-11
▪ 10.2.3.9.2 Task steps	.....	10-11
<b>10.2.3.10 Capitalization, punctuation, and hyphenation</b>	.....	<b>10-11</b>
▪ 10.2.3.10.1 Capitalization	.....	10-11
▪ 10.2.3.10.2 Capitalization of phrases for emphasis	.....	10-11
▪ 10.2.3.10.3 Punctuation	.....	10-11
▪ 10.2.3.10.4 Hyphenation	.....	10-11
<b>10.2.4 Words and symbols</b>	.....	<b>10-12</b>
<b>10.2.4.1 Consistency</b>	.....	<b>10-12</b>
□ 10.2.4.1.1 Terminology	.....	10-12
<b>10.2.4.2 Short, high-frequency words</b>	.....	<b>10-12</b>
□ 10.2.4.2.1 High-frequency words	.....	10-12
□ 10.2.4.2.2 Short words	.....	10-12
□ 10.2.4.2.3 Simple words	.....	10-13
<b>10.2.4.3 Concrete, nonambiguous words</b>	.....	<b>10-13</b>
□ 10.2.4.3.1 Concrete versus abstract words	.....	10-13
▪ 10.2.4.3.2 Ambiguous words	.....	10-13
□ 10.2.4.3.3 Indefinite words and terms	.....	10-13
▪ 10.2.4.3.4 Variations on flammable	.....	10-13
<b>10.2.4.4 Standard verbs</b>	.....	<b>10-13</b>
▪ 10.2.4.4.1 List of standard verbs	.....	10-13

<b>10.2.4.5 Other standard words</b>	.....	<b>10-13</b>
□ 10.2.4.5.1 If, when, and where	.....	10-13
■ 10.2.4.5.2 Shall, should, may, and will	.....	10-14
<b>10.2.4.6 Pronouns</b>	.....	<b>10-14</b>
■ 10.2.4.6.1 Unambiguous referents	.....	10-14
<b>10.2.4.7 Definitions</b>	.....	<b>10-14</b>
■ 10.2.4.7.1 What to define	.....	10-14
■ 10.2.4.7.2 When to define	.....	10-14
□ 10.2.4.7.3 Repeated definitions	.....	10-14
■ 10.2.4.7.4 Glossary	.....	10-14
<b>10.2.4.8 Abbreviations and acronyms</b>	.....	<b>10-14</b>
■ 10.2.4.8.1 Use	.....	10-15
■ 10.2.4.8.2 Definition of abbreviations and acronyms	.....	10-15
□ 10.2.4.8.3 Repeated definitions	.....	10-15
■ 10.2.4.8.4 Glossary	.....	10-16
■ 10.2.4.8.5 Standard abbreviations and acronyms	.....	10-16
□ 10.2.4.8.6 Nonstandard abbreviations	.....	10-16
■ 10.2.4.8.7 Units of measurement	.....	10-16
□ 10.2.4.8.8 e.g. and i.e.	.....	10-16
<b>10.2.4.9 Spelling</b>	.....	<b>10-16</b>
■ 10.2.4.9.1 Spelling	.....	10-16
<b>10.2.4.10 Numbers</b>	.....	<b>10-17</b>
■ 10.2.4.10.1 Numerals versus words	.....	10-17
□ 10.2.4.10.2 Arabic numerals	.....	10-17
□ 10.2.4.10.3 Decimals versus fractions	.....	10-17
■ 10.2.4.10.4 Decimals and leading and trailing zeros	.....	10-17
<b>10.2.4.11 Units of measurement</b>	.....	<b>10-17</b>
■ 10.2.4.11.1 Dual units	.....	10-17
■ 10.2.4.11.2 Conversion of units	.....	10-17
<b>10.2.4.12 Letter symbols and mathematical signs</b>	.....	<b>10-18</b>
■ 10.2.4.12.1 Letter symbols for semiconductor devices	.....	10-18

<b>10.2.4.13 Graphic symbols</b>	.....	<b>10-18</b>
▪ 10.2.4.13.1 Standard graphic symbols	.....	10-18
▪ 10.2.4.13.2 Mechanical diagram symbols	.....	10-18
▪ 10.2.4.13.3 Logic diagram symbols	.....	10-18
<b>10.2.4.14 Other symbols</b>	.....	<b>10-18</b>
▪ 10.2.4.14.1 Flow chart symbols	.....	10-18
▪ 10.2.4.14.2 Special symbols	.....	10-18
<b>10.3 Layout and formatting</b>	.....	<b>10-19</b>
<b>10.3.1 Document-level considerations</b>	.....	<b>10-19</b>
<b>10.3.1.1 Size</b>	.....	<b>10-19</b>
□ 10.3.1.1.1 Basic size	.....	10-19
□ 10.3.1.1.2 Standard sizes	.....	10-19
□ 10.3.1.1.3 Avoidance of odd sizes	.....	10-19
<b>10.3.1.2 Binding</b>	.....	<b>10-19</b>
□ 10.3.1.2.1 Page orientation	.....	10-20
□ 10.3.1.2.2 Flat-lying	.....	10-20
□ 10.3.1.2.3 Easy updating	.....	10-20
<b>10.3.2 Page-level considerations</b>	.....	<b>10-20</b>
<b>10.3.2.1 Margins</b>	.....	<b>10-20</b>
▪ 10.3.2.1.1 Consistency	.....	10-20
▪ 10.3.2.1.2 Pages 8.5 by 11 inches (21.6 by 27.9 cm) or larger	.....	10-20
□ 10.3.2.1.3 Pages smaller than 8.5 by 11 (21.6 by 27.9 cm)	.....	10-20
<b>Exhibit 10.3.2.1.3</b> Margin sizes for standard paper sizes	....	10-21
▪ 10.3.2.1.4 Offset for binding	.....	10-21
<b>10.3.2.2 Headers and footers</b>	.....	<b>10-21</b>
□ 10.3.2.2.1 Location information	.....	10-21
□ 10.3.2.2.2 Use of headers and footers	.....	10-21
□ 10.3.2.2.3 Location of information within a header or footer	.....	10-21
□ 10.3.2.2.4 Headers, footers, and margins	.....	10-22

<b>10.3.2.3 White space</b>	.....	<b>10-22</b>
□ 10.3.2.3.1 Representational vertical spacing	.....	10-22
□ 10.3.2.3.2 Horizontal spacing (indentation)	.....	10-22
<b>10.3.2.4 Paragraphs</b>	.....	<b>10-23</b>
□ 10.3.2.4.1 Indentation of first line	.....	10-23
<b>10.3.2.5 Right- and left-hand pages</b>	.....	<b>10-23</b>
□ 10.3.2.5.1 Major divisions of the document	.....	10-23
■ 10.3.2.5.2 Page numbering of left and right handed pages	...	10-23
<b>10.3.2.6 Page numbering</b>	.....	<b>10-23</b>
■ 10.3.2.6.1 Arabic numerals	.....	10-24
□ 10.3.2.6.2 Numbering style - body	.....	10-24
□ 10.3.2.6.3 Numbering style - front material	.....	10-24
□ 10.3.2.6.4 Numbering style - Appendixes	.....	10-24
■ 10.3.2.6.5 Location	.....	10-24
<b>10.3.2.7 Columns</b>	.....	<b>10-24</b>
■ 10.3.2.7.1 Number of columns	.....	10-24
□ 10.3.2.7.2 White space in columns	.....	10-24
□ 10.3.2.7.3 Column width	.....	10-25
<b>10.3.2.8 Foldout pages</b>	.....	<b>10-25</b>
□ 10.3.2.8.1 Minimize use	.....	10-25
■ 10.3.2.8.2 Foldout to the right	.....	10-25
□ 10.3.2.8.3 Right-hand pages	.....	10-25
■ 10.3.2.8.4 Visibility of page number and caption	.....	10-25
■ 10.3.2.8.5 Visibility of entire exhibit	.....	10-25
□ 10.3.2.8.6 Location of foldout pages	.....	10-25
■ 10.3.2.8.7 Foldout pages as a separate series	.....	10-26
<b>10.3.3 Typographic issues</b>	.....	<b>10-26</b>
<b>10.3.3.1 Type size</b>	.....	<b>10-26</b>
□ 10.3.3.1.1 Basic size	.....	10-26
□ 10.3.3.1.2 Minimum size	.....	10-26
□ 10.3.3.1.3 Unequal spacing of sizes	.....	10-26
□ 10.3.3.1.4 Number of different sizes	.....	10-27
<b>10.3.3.2 Line length</b>	.....	<b>10-27</b>
□ 10.3.3.2.1 Line length	.....	10-27

<b>10.3.3.3 Line spacing</b>	.....	<b>10-27</b>
□ 10.3.3.3.1 Minimum spacing	.....	10-27
<b>10.3.3.4 Justification</b>	.....	<b>10-27</b>
□ 10.3.3.4.1 Justification of text	.....	10-28
□ 10.3.3.4.2 Appropriate use of right-justification	.....	10-28
□ 10.3.3.4.3 Avoiding hyphenation	.....	10-28
<b>10.3.3.5 Type style (font)</b>	.....	<b>10-28</b>
□ 10.3.3.5.1 Serifs for basic font	.....	10-28
□ 10.3.3.5.2 Minimize different fonts	.....	10-28
<b>10.3.3.6 Upper versus mixed case text</b>	.....	<b>10-28</b>
■ 10.3.3.6.1 When to use upper case letters	.....	10-29
■ 10.3.3.6.2 Words to be typed in upper case letters	.....	10-29
□ 10.3.3.6.3 Minimize use of upper case letters	.....	10-29
<b>10.3.3.7 Typographic emphasis</b>	.....	<b>10-29</b>
■ 10.3.3.7.1 Inform the reader	.....	10-29
■ 10.3.3.7.2 Use boldface type for emphasis	.....	10-29
■ 10.3.3.7.3 Use typographic emphasis sparingly	.....	10-29
□ 10.3.3.7.4 Do not use underlining for emphasis	.....	10-29
■ 10.3.3.7.5 Do not use italics for emphasis	.....	10-30
□ 10.3.3.7.6 Do not use upper case letters for emphasis	.....	10-30
■ 10.3.3.7.7 Do not use quotation marks for emphasis	.....	10-30
<b>10.3.3.8 Print contrast, quality</b>	.....	<b>10-30</b>
■ 10.3.3.8.1 Adequate print contrast	.....	10-30
<b>10.3.3.9 Color and shading</b>	.....	<b>10-31</b>
■ 10.3.3.9.1 Color as a typographic cue	.....	10-31
■ 10.3.3.9.2 Text in color	.....	10-31
■ 10.3.3.9.3 Subsequent reproduction	.....	10-31
<b>10.4 Components of documents</b>	.....	<b>10-31</b>
<b>Exhibit 10.4</b> FAA directives and order of document components	.....	10-32
<b>10.4.1 Cover page</b>	.....	<b>10-33</b>
■ 10.4.1.1 Contents of cover page	.....	10-33

■ 10.4.1.2 Type style and size, 8.5 by 11 inch (21.6 by 27.9 cm) pages .....	10-33
<b>Exhibit 10.4.1.2</b> Type sizes for cover page elements .....	10-34
□ 10.4.1.3 Type family .....	10-34
□ 10.4.1.4 Type size, other than 8.5 by 11 inch (21.6 by 27.9 cm) pages .....	10-34
 <b>10.4.2 Table of contents</b> .....	<b>10-34</b>
■ 10.4.2.1 When to include a table of contents .....	10-34
■ 10.4.2.2 Labeling the table of contents .....	10-34
■ 10.4.2.3 What to include in the table of contents .....	10-34
■ 10.4.2.4 Right-hand page .....	10-34
 <b>10.4.3 Lists of exhibits</b> .....	<b>10-35</b>
■ 10.4.3.1 When to use lists of exhibits .....	10-35
■ 10.4.3.2 Contents of lists of exhibits .....	10-35
■ 10.4.3.3 Location and precedence of lists .....	10-35
 <b>10.4.4 Figures</b> .....	<b>10-35</b>
<b>10.4.4.1 General</b> .....	<b>10-35</b>
■ 10.4.4.1.1 When to use .....	10-35
■ 10.4.4.1.2 Relationship to text .....	10-35
<b>10.4.4.2 Identification</b> .....	<b>10-35</b>
■ 10.4.4.2.1 Number and title .....	10-35
■ 10.4.4.2.2 Caption .....	10-36
<b>10.4.4.3 Location</b> .....	<b>10-36</b>
■ 10.4.4.3.1 Figure follows reference .....	10-36
□ 10.4.4.3.2 Preferred location .....	10-36
□ 10.4.4.3.3 Consistent location .....	10-36
<b>10.4.4.4 Style</b> .....	<b>10-36</b>
■ 10.4.4.4.1 Consistent style .....	10-36
□ 10.4.4.4.2 Preferred pictorial style .....	10-36
□ 10.4.4.4.3 Consistent pictorial style .....	10-36
■ 10.4.4.4.4 Minimal distraction .....	10-36
■ 10.4.4.4.5 Alphanumeric information .....	10-37
■ 10.4.4.4.6 Line width .....	10-37
■ 10.4.4.4.7 Color .....	10-37



<b>10.4.4.5 Content</b>	.....	<b>10-37</b>
▪ 10.4.4.5.1 Amount of detail	.....	10-37
▪ 10.4.4.5.2 Callouts	.....	10-37
▪ 10.4.4.5.3 Specific types of diagrams	.....	10-37
<b>10.4.4.6 Orientation</b>	.....	<b>10-37</b>
□ 10.4.4.6.1 Preferred orientation	.....	10-37
▪ 10.4.4.6.2 Alternate orientation	.....	10-38
<b>10.4.4.7 Oversize figures</b>	.....	<b>10-38</b>
□ 10.4.4.7.1 Facing pages	.....	10-38
▪ 10.4.4.7.2 Captions for divided figures	.....	10-38
▪ 10.4.4.7.3 Foldout pages	.....	10-38
<b>10.4.5 Tables</b>	.....	<b>10-38</b>
<b>10.4.5.1 General</b>	.....	<b>10-38</b>
□ 10.4.5.1.1. When to use	.....	10-38
<b>10.4.5.2 Identification</b>	.....	<b>10-38</b>
▪ 10.4.5.2.1 Number and title	.....	10-38
▪ 10.4.5.2.2 Caption	.....	10-39
<b>10.4.5.3 Location</b>	.....	<b>10-39</b>
▪ 10.4.5.3.1 Table follows reference	.....	10-39
□ 10.4.5.3.2 Preferred location	.....	10-39
□ 10.4.5.3.3 Consistent location	.....	10-39
<b>10.4.5.4 Formatting</b>	.....	<b>10-39</b>
▪ 10.4.5.4.1 Organization	.....	10-39
▪ 10.4.5.4.2 Type size	.....	10-39
▪ 10.4.5.4.3 Row and column labels	.....	10-39
▪ 10.4.5.4.4 Units of measurement	.....	10-39
▪ 10.4.5.4.5 Ease of reading	.....	10-39
<b>10.4.5.5 Content</b>	.....	<b>10-40</b>
▪ 10.4.5.5.1 Useful and relevant	.....	10-40
▪ 10.4.5.5.2 Nonredundant information	.....	10-40
<b>10.4.5.6 Orientation</b>	.....	<b>10-40</b>
□ 10.4.5.6.1 Preferred orientation	.....	10-40
▪ 10.4.5.6.2 Alternate orientation	.....	10-40

<b>10.4.5.7 Oversize tables</b>	.....	<b>10-40</b>
□ 10.4.5.7.1 Facing pages	.....	10-40
■ 10.4.5.7.2 Captions for divided tables	.....	10-40
■ 10.4.5.7.3 Foldout pages	.....	10-40
<b>10.4.6 Lists</b>	.....	<b>10-41</b>
□ 10.4.6.1 When to use	.....	10-41
■ 10.4.6.2 Format	.....	10-41
□ 10.4.6.3 Marks	.....	10-41
□ 10.4.6.4 Consistency of items	.....	10-41
□ 10.4.6.5 Punctuation - items	.....	10-41
<b>10.4.7 Formulas and equations</b>	.....	<b>10-41</b>
■ 10.4.7.1 Identification	.....	10-41
□ 10.4.7.2 Location	.....	10-42
■ 10.4.7.3 Format	.....	10-42
<b>10.4.8 Warnings, cautions, and notes</b>	.....	<b>10-42</b>
■ 10.4.8.1 Format	.....	10-42
■ 10.4.8.2 Warnings	.....	10-42
■ 10.4.8.3 Cautions	.....	10-42
■ 10.4.8.4 Notes	.....	10-42
■ 10.4.8.5 Precedence of warnings, cautions, and notes	.....	10-43
■ 10.4.8.6 No procedural steps	.....	10-43
<b>10.4.9 Appendixes</b>	.....	<b>10-43</b>
□ 10.4.9.1 When to use	.....	10-43
■ 10.4.9.2 Relation to main body	.....	10-43
□ 10.4.9.3 Identification	.....	10-43
■ 10.4.9.4 Location	.....	10-43
■ 10.4.9.5 Page numbering	.....	10-43
■ 10.4.9.6 Pagination	.....	10-44
<b>10.4.10 Glossary</b>	.....	<b>10-44</b>
■ 10.4.10.1 Terms	.....	10-44
■ 10.4.10.2 Format	.....	10-44
■ 10.4.10.3 Location	.....	10-44
<b>10.4.11 Index</b>	.....	<b>10-44</b>
■ 10.4.11.1 When to use	.....	10-44
■ 10.4.11.2 Format and content	.....	10-44
□ 10.4.11.3 Level of detail	.....	10-44

<b>10.4.12 User feedback forms</b>	.....	<b>10-44</b>
▪ 10.4.12.1 When to use	.....	10-44
▪ 10.4.12.2 Location	.....	10-45
▪ 10.4.12.3 Content	.....	10-45
<b>Exhibit 10.4.12.3 (a) User feedback form - Front</b>	.....	10-46
<b>Exhibit 10.4.12.3 (b) User feedback form-Back</b>	.....	10-47
▪ 10.4.12.4 Number of copies	.....	10-45
<b>10.4.13 Tabs</b>	.....	<b>10-45</b>
□ 10.4.13.1 When to use	.....	10-45
<b>10.4.14 Footnotes</b>	.....	<b>10-45</b>
▪ 10.4.14.1 Minimize use of footnotes	.....	10-45
▪ 10.4.14.2 Identification	.....	10-48
▪ 10.4.14.3 Location	.....	10-48
▪ 10.4.14.4 Additional rules	.....	10-48
<b>10.4.15 Copyright and patent issues</b>	.....	<b>10-48</b>
▪ 10.4.15.1 Copyrighted documents	.....	10-48
▪ 10.4.15.2 Inclusion of copyrighted or patented material	.....	10-48
<b>10.4.16 Publication date</b>	.....	<b>10-48</b>
▪ 10.4.16.1 Location	.....	10-48
<b>10.5 Specific user document contents</b>	.....	<b>10-48</b>
<b>10.5.1 Proceduralized instructions</b>	.....	<b>10-48</b>
<b>10.5.1.1 General</b>	.....	<b>10-49</b>
▪ 10.5.1.1.1 Procedures, tasks, subtasks, and steps	.....	10-49
▪ 10.5.1.1.2 Level of detail	.....	10-49
▪ 10.5.1.1.3 Completeness	.....	10-49
▪ 10.5.1.1.4 Safety considerations	.....	10-49
▪ 10.5.1.1.5 General safety instructions	.....	10-49

<b>10.5.1.2 Organization and content</b>	.....	<b>10-50</b>
▪ 10.5.1.2.1 Hierarchical, logical, and consistent	.....	10-50
▪ 10.5.1.2.2 Identifying information	.....	10-50
▪ 10.5.1.2.3 Title	.....	10-50
▪ 10.5.1.2.4 Headings	.....	10-50
▪ 10.5.1.2.5 Numbered steps	.....	10-50
▪ 10.5.1.2.6 Supporting information	.....	10-50
□ 10.5.1.2.7 Appendixes and attachments	.....	10-51
<b>10.5.1.3 Format</b>	.....	<b>10-51</b>
▪ 10.5.1.3.1 Step numbers and text	.....	10-51
□ 10.5.1.3.2 Check off provision	.....	10-51
□ 10.5.1.3.3 Lists	.....	10-51
▪ 10.5.1.3.4 Illustrations	.....	10-51
<b>10.5.1.4 Typographic matters</b>	.....	<b>10-51</b>
▪ 10.5.1.4.1 Legibility	.....	10-51
▪ 10.5.1.4.2 Justification	.....	10-52
▪ 10.5.1.4.3 Typographic emphasis	.....	10-52
<b>10.5.1.5 Wording of steps</b>	.....	<b>10-52</b>
▪ 10.5.1.5.1 Completeness	.....	10-52
▪ 10.5.1.5.2 Grammar	.....	10-52
▪ 10.5.1.5.3 Capitalization, punctuation, and hyphenation	.....	10-52
▪ 10.5.1.5.4 Action statements and indication statements	.....	10-52
▪ 10.5.1.5.5 List of standard verbs	.....	10-52
▪ 10.5.1.5.6 Sentences	.....	10-52
▪ 10.5.1.5.7 Words and symbols	.....	10-52
▪ 10.5.1.5.8 Standard steps	.....	10-52
▪ 10.5.1.5.9 Conditional steps	.....	10-53
▪ 10.5.1.5.10 No calculations	.....	10-53
□ 10.5.1.5.11 Numerical precision	.....	10-53
▪ 10.5.1.5.12 Numerical ranges	.....	10-53
<b>10.5.1.6 Warnings, cautions, and notes in proceduralized instructions</b>	.....	<b>10-53</b>
▪ 10.5.1.6.1 Use	.....	10-53
<b>10.5.1.7 Branching and cross-references</b>	.....	<b>10-53</b>
▪ 10.5.1.7.1 Minimize use	.....	10-53
▪ 10.5.1.7.2 Explicit instructions	.....	10-54
▪ 10.5.1.7.3 Content	.....	10-54

<b>10.5.1.8 Miscellaneous</b>	.....	<b>10-54</b>
▪ 10.5.1.8.1 Simultaneous actions or indications	.....	10-54
□ 10.5.1.8.2 Format for diagnostic steps	.....	10-54
□ 10.5.1.8.3 Nonsequential steps	.....	10-54
□ 10.5.1.8.4 Verification steps	.....	10-54
□ 10.5.1.8.5 Equally-acceptable steps	.....	10-54
▪ 10.5.1.8.6 Actions performed from memory	.....	10-54
▪ 10.5.1.8.7 Procedures involving more than one person	.....	10-55
<b>10.5.2 Interactive electronic technical manuals</b>	.....	<b>10-55</b>
<b>10.5.2.1 General</b>	.....	<b>10-55</b>
▪ 10.5.2.1.1 Contents	.....	10-55
▪ 10.5.2.1.2 Access to contents	.....	10-55
▪ 10.5.2.1.3 Help information	.....	10-55
▪ 10.5.2.1.4 Safety summary	.....	10-56
<b>10.5.2.2 Text</b>	.....	<b>10-56</b>
▪ 10.5.2.2.1 Applicable information	.....	10-56
▪ 10.5.2.2.2 Level of detail	.....	10-56
▪ 10.5.2.2.3 Procedures in steps	.....	10-56
▪ 10.5.2.2.4 Accommodating novice and expert skill levels	.....	10-56
▪ 10.5.2.2.5 Writing the text	.....	10-57
<b>10.5.2.3 Graphics</b>	.....	<b>10-57</b>
▪ 10.5.2.3.1 General requirements	.....	10-57
▪ 10.5.2.3.2 Minimum quality	.....	10-57
▪ 10.5.2.3.3 Interaction with graphics	.....	10-57
▪ 10.5.2.3.4 Detail and context	.....	10-57
▪ 10.5.2.3.5 Citations of equipment nomenclature	.....	10-57
▪ 10.5.2.3.6 Angle of view	.....	10-58
▪ 10.5.2.3.7 Use of a human figure	.....	10-58
▪ 10.5.2.3.8 Callouts	.....	10-58
▪ 10.5.2.3.9 Schematic and wiring diagrams	.....	10-58
▪ 10.5.2.3.10 Functional flow diagrams	.....	10-58
▪ 10.5.2.3.11 Locator graphics	.....	10-58
▪ 10.5.2.3.12 Placement of locator graphics	.....	10-58
▪ 10.5.2.3.13 Exploded item views	.....	10-59
▪ 10.5.2.3.14 Minimum size of a locator graphic	.....	10-59
▪ 10.5.2.3.15 Animated information	.....	10-59
▪ 10.5.2.3.16 Video controls	.....	10-59
<b>10.5.2.4 Audio</b>	.....	<b>10-59</b>
▪ 10.5.2.4.1 Redundant visual information	.....	10-59
▪ 10.5.2.4.2 When to use nonverbal auditory signals	.....	10-59
▪ 10.5.2.4.3 When to use computer-generated and electronically-stored speech	.....	10-59
▪ 10.5.2.4.4 Audio controls	.....	10-59

	<ul style="list-style-type: none"> <li>▪ 10.5.2.4.5 Pronunciation of abbreviations ..... 10-60</li> <li>▪ 10.5.2.4.6 Pronunciation of alphanumeric strings ..... 10-60</li> </ul>	
<b>10.5.2.5 Warnings, cautions, and notes</b>	.....	<b>10-60</b>
	<ul style="list-style-type: none"> <li>▪ 10.5.2.5.1 When to include warnings and cautions ..... 10-60</li> <li>▪ 10.5.2.5.2 Readable and comprehensible ..... 10-60</li> <li>▪ 10.5.2.5.3 Association of warnings and cautions with text ..... 10-60</li> <li>▪ 10.5.2.5.4 Location of warnings, cautions, and notes ..... 10-60</li> <li>▪ 10.5.2.5.5 Color in warnings, caution, and note displays ..... 10-61</li> <li>▪ 10.5.2.5.6 Borders for warnings, cautions, and notes ..... 10-61</li> <li>▪ 10.5.2.5.7 When to use notes ..... 10-61</li> <li>▪ 10.5.2.5.8 Association of notes with text ..... 10-61</li> </ul>	
<b>10.5.2.6 Interaction style</b>	.....	<b>10-61</b>
	<ul style="list-style-type: none"> <li>▪ 10.5.2.6.1 Dialog boxes ..... 10-61</li> <li>▪ 10.5.2.6.2 Dialogs ..... 10-61</li> <li>▪ 10.5.2.6.3 Prompts ..... 10-61</li> <li>▪ 10.5.2.6.4 Changing responses to prompts ..... 10-61</li> <li>▪ 10.5.2.6.5 Alert dialogs ..... 10-61</li> <li>▪ 10.5.2.6.6 Navigation operations ..... 10-62</li> <li>▪ 10.5.2.6.7 Data access operations and features ..... 10-62</li> </ul>	
<b>10.5.2.7 User interface</b>	.....	<b>10-63</b>
	<ul style="list-style-type: none"> <li>▪ 10.5.2.7.1 User-manual interaction ..... 10-63</li> <li>▪ 10.5.2.7.2 Display formatting ..... 10-63</li> <li>▪ 10.5.2.7.3 Consistency ..... 10-63</li> <li>▪ 10.5.2.7.4 Window presentation ..... 10-63</li> </ul>	
<b>10.5.2.8 Special requirements for proceduralized instructions</b>	.....	<b>10-63</b>
	<ul style="list-style-type: none"> <li>▪ 10.5.2.8.1 Form and content ..... 10-63</li> <li>▪ 10.5.2.8.2 General ..... 10-63</li> </ul>	
<b>10.5.2.9 Special requirements for troubleshooting information</b>	.....	<b>10-63</b>
	<ul style="list-style-type: none"> <li>▪ 10.5.2.9.1 Troubleshooting logic ..... 10-63</li> <li>▪ 10.5.2.9.2 Contents ..... 10-64</li> <li>▪ 10.5.2.9.3 User inputs ..... 10-64</li> <li>▪ 10.5.2.9.4 Predefined fault isolation sequences ..... 10-64</li> <li>▪ 10.5.2.9.5 Presentation of a predefined fault isolation sequence ..... 10-64</li> <li>▪ 10.5.2.9.6 Dynamically-generated fault isolation recommendations ..... 10-64</li> <li>▪ 10.5.2.9.7 Presentation of dynamically-generated fault isolation recommendations ..... 10-65</li> </ul>	

<b>10.5.2.10 Presentation of parts information</b>	.....	<b>10-65</b>
▪ 10.5.2.10.1 Information available	.....	10-65
▪ 10.5.2.10.2 Accessibility of parts information	.....	10-65
▪ 10.5.2.10.3 Direct access	.....	10-65
<b>10.5.2.11 Descriptive information</b>	.....	<b>10-66</b>
▪ 10.5.2.11.1 Information available	.....	10-66
▪ 10.5.2.11.2 Presentation of descriptive information	.....	10-66
<b>10.6 Accommodating people with disabilities</b>	.....	<b>10-66</b>
□ 10.6.1 Electronic documentation	.....	10-66
□ 10.6.2 Convertible format	.....	10-66
□ 10.6.3 Readability and handling	.....	10-66
□ 10.6.4 Understandability	.....	10-67





## 10 User documentation

This section provides criteria and guidelines for the development of documents that will be used by operators and maintainers in the performance of routine and corrective maintenance of systems and equipment. User documentation includes user guides and manuals, maintenance handbooks and technical instructions, job performance aids, quick reference guides, and instruction placards.

To be successful, a document must be appropriate to the knowledge and skills of its users, to the tasks they will perform using the document, and to the environment in which the users will perform these tasks. To ensure success, document development might include the following steps: (1) determine the relevant characteristics of the users of the document, in particular, their existing knowledge and skills, (2) determine the environment in which the document will be used, (3) determine the tasks to be covered by the document, (4) determine the users' information requirements, (5) determine the appropriate types of documentation, (6) create draft documents, (7) perform technical review(s), (8) perform usability tests, and (9) prepare documentation for release.

User documentation is part of the interface between the users and other system components. It contributes to the user's cognitive understanding of the hardware, software, and human interactions with these other components of the system. It can serve as a job aid and as a supplement to (but not a substitute for) system training. Thus, this section contributes to the usability and effectiveness of the operational system and is to be applied to new systems and equipment acquisitions and modifications as a part of development and procurement.

The first part of this section is devoted to criteria and guidelines for the development of printed user documentation in general. These general topics include organizing the document, writing the text, and laying out the page. These topics are followed by criteria and guidelines for the individual components that comprise a user document, such as the title page, figures, instructions, and indexes.

### 10.1 General

The users of a document want the document to help them perform their tasks quickly and efficiently. However, these users differ from each other in many ways—in level of expertise, in motivation, in time constraints, in work styles, in reading abilities, in attitudes, in personal preferences, in age, and so on. The more these differences are accommodated, the more effective a document will be to its individual users. Section 10.1 prescribes some ways to match documentation to users.

### 10.1.1 Matching documentation to users

- **10.1.1.1 Description of expected users.** The procuring agency shall provide a description of the expected users of the document to the document contractor. The description would include the following sorts of information: (1) aptitude profile, (2) reading level, (3) time in job, (4) job-related training, (5) job-related work experience, and (6) job-related skills, knowledge and duties. This description could be iterated between the procuring agency and the technical writers until they mutually agree that it is sufficient.

**Example.** FAA-D-2492/b, Technical Instruction Book Manuscript: Electronic, Electrical, and Mechanical Equipment, Requirements for Preparation of Manuscript and Production of Books, provides a general level description of some of these user characteristics, as well as instruction and maintenance environments in its paragraph 3.1.1 on writing level for these books.

- **10.1.1.2 Documentation for people at different skill levels.** If the users of a document are expected to vary widely in their skills and levels of experience, the document shall permit use in different ways by people at different levels, or different versions of the document shall be prepared for people at different levels. If a single document is designed for use by people with different skill levels, use by people at one level shall not be hindered by the material relevant to a different level.

**Examples.** Beginning users can be guided to a tutorial, help process, or an entry-level document. Separate reference documents can be written for beginners, advanced users, and experts. A document intended for "novices" and "power users" of computer applications programs may give a procedure to select a sequence of windows for the novices and keyboard codes for direct control selection by the power users. Novice users might be given detailed, step-by step instructions to complete a procedure, while expert users might simply be given the name of the procedure to be completed -- a sort of checklist.

Another approach is to code information for different skill levels. Font size and type, opposite or alternative pages or paragraphs, shaded or color-coded boxes or borders, and position location on a page can be used to indicate applicable skill levels. For instance, location coding is typically used when multiple languages are presented for identical instructions.

### 10.1.2 Making documentation appear easy to use

Some components of a document affect users' perceptions of its attractiveness and its apparent ease of use. These components are listed here in their order of importance to users' perceptions.

- **10.1.2.1 Tabs.** If a document has many divisions (5 or more), it should have tabs for each major division or for each frequently-used division (see also paragraph 10.4.13.1).

**Examples.** This document uses an edge tab on the side of the insert page. A bleed-through marking at the same edge location on each page in a section, chapter, or topic can mark and divide topics.

- **10.1.2.2 Guides to organization.** User documents should have informative titles and, if applicable, a discernable, hierarchical system of section headings. Different levels of headings should be differentiated with typographic cuing, for example, size and boldness of the type (see sections 10.2.1.1 and 10.3.3). White space, color, font type, and font sizes can be used judiciously if they aid in locating and categorizing information and contribute to readability and appearance of the document. They then result in a usable and friendly document.
- **10.1.2.3 Table of contents.** A user document shall have a table of contents unless it has fewer than three divisions or fewer than six pages (same as paragraph 10.4.2.1). The table of contents shall not appear crowded, that is, it shall have a liberal amount of white space, and it shall use typographic cuing to differentiate among levels of headings (see sections 10.4.2 and 10.3.3).
- **10.1.2.4 Figures and examples.** User documents should be generous in providing figures and examples. Information that can be effectively presented as a figure or exhibit, should be.
- **10.1.2.5 Lists and tables.** Any information that can be presented in lists and tables instead of prose should be so presented.

## 10.2 Writing user documentation

This section contains criteria and guidelines for organizing a document, for writing and presenting paragraphs and sentences, and for choosing and using words and symbols, including abbreviations and acronyms. For a concise general reference on usage, composition, form, words and expressions, and style see Strunk and White, *The Elements of Style*, third edition.

### 10.2.1 Organization

Good documentation has a clear conceptual organization. The organization needs to be compatible with its purpose and understandable to its users. The organization helps the users find relevant information in order to carry out their functions and tasks. There are three major ways to help the user understand the conceptual organization: (1) the use of titles and headings, (2) the visual appearance of the document, and (3) a hierarchical numbering system.

**Discussion.** The features of the document can be reviewed for input by a user group early in its development. These users can contribute to its conceptual organization.

This section includes guidelines on the use of a variety of techniques that can help users use a document more effectively.

### 10.2.1.1 Titles and headings

Titles and headings are of major importance to users; they help users find relevant information, understand the organization of the document, and maintain awareness of their location in the document.

**Definitions.** A **title** is a word or phrase that describes or identifies the contents of a document or a portion of a document. A **heading** is the title of an organizational subdivision of a document, that is, a title that has hierarchical significance.

**Discussion.** Headings are usually set apart from the text to which they refer in a way that indicates the hierarchical structure of the document. This may be accomplished with the use of horizontal and vertical spacing. In addition, headings are usually differentiated from text typographically, for example, by the use of larger type size or increased boldness, or both.

**Example.** This document uses up to four levels of headings in each major section. They are distinguished by type size and vertical separation in the left hand column on the pages. Section 10 heading is set in 21 point bold type, second level headings such as 10.1 and 10.2 are likewise positioned, bolded, and vertically separated and set in 17 point bold type. When used as headings, third and fourth level numbers are set in 14 and 12 point bold types. The titles of text paragraphs which identify the contents of rules are always positioned in the right hand column and are set with the number in 10 point bold type and the text content title in 12 point bold type. From a human factors perspective, these features capitalize upon the user's ability to navigate through and find information. They aid the user of the document through location (position and spacing), size, and appearance (bolding) coding.

- **10.2.1.1.1 Titles.** A document shall have a title, and its major subdivisions shall have headings. These titles and headings shall be brief, descriptive, and distinctive. That is, within the constraint of being as brief as possible, a title or heading shall identify the contents of the document or division with sufficient detail to distinguish it from similar documents or divisions.
- **10.2.1.1.2 Paragraph titles.** If practical, each paragraph shall have a title that identifies its contents. Paragraph titles are practical if they help users in finding relevant information, if they contribute to understanding the paragraph contents, or if they are desired by the users.
- **10.2.1.1.3 Hierarchy.** The titles and headings used in a document shall constitute a hierarchy that is reflected typographically. That is, the appearance of a title shall indicate its level in the hierarchy. The aspects of appearance that can be used for this purpose include size, boldness, spacing, and location.

- **10.2.1.1.4 Uniqueness of titles.** Titles and headings shall not be repeated within a major division of a document.

### 10.2.1.2 Numbering of sections and subsections

- **10.2.1.2.1 Decimal numbering.** The subdivisions of a document should be numbered in a way that reflects the organization of the document. This can be accomplished by: (1) assigning consecutive numbers to the major divisions of the document, beginning with 1 for the first, 2 for the second, and so on, (2) following this number with a period, (3) assigning consecutive numbers beginning with one to each subdivision, if any, of each major division and appending this number to that of the preceding division, (4) following this number with a period, and (5) continuing this process with any additional subdivisions until the paragraph level is reached. The final number should not be followed with a period.

**Example.** This document complies with the recommended decimal numbering.

- **10.2.1.2.2 Itemization within a paragraph.** If it is necessary to identify individual items within a paragraph, they should be identified with lower case letters so that they are not confused with the decimal numbering system.

**Exception.** This document illustrates two different kinds of itemization within a paragraph. When the items are presented as a list, they comply with this guideline. When they are presented as continuous text in a paragraph, they are identified by numbers in parentheses. For example, paragraph 10.2.1.2.1 illustrates itemization by numbering in parentheses, and paragraph 10.2.4.8.5 illustrates identification with lower case letters.

- **10.2.1.2.3 Number of levels.** If possible, the numbering system should not exceed five levels, that is, the number of subdivisions from the document as a whole to its numbered paragraphs should not exceed five. When the material and its potential organization lend itself to fewer levels, four or three would be preferable.

**Discussion.** There is no "right" number of subdivisions for a document; whatever makes sense to the user is right as long as he or she can use it without difficulty. However, any numbering system becomes increasingly unwieldy as the number of subdivisions increases. Five levels is considered a reasonable limit. A rule of thumb from memory research is that people can generally remember five plus or minus two items or chunks of information. From a design point of view, the preference is to accommodate many people, thus, use fewer categories.

### 10.2.1.3 Advance organizers

Advance organizers have been shown to improve comprehension and retention of material that is unfamiliar to readers.

**Definition.** An advance organizer is supplementary information that is presented prior to the main body of information in which a user is interested.

**Examples.** Tables of contents, introductory summaries, flow charts, and adjunct questions are all advance organizers as long as they occur before the targeted information.

- **10.2.1.3.1 When to provide advance organizers.** If users are likely to be relatively unfamiliar with the contents of a document, one or more advance organizers should be included.

**Examples.** An introductory summary that states the main points or provides a framework for a document or a division of a document can be an effective advance organizer. A bulletized, advanced summary provides the user with a list of topics that can be easily scanned. Headings in the form of questions are also effective advance organizers. Any document of more than a few pages will probably benefit from a table of contents.

In this document, introductory textual information, and in some instances even exhibit information, is given in the right hand column and is associated with high level (first and second section level) headings. This introductory information is presented to give some advanced organization, orientation, or usage limitations for the section contents. Such information is optional for lower level headings.

#### 10.2.1.4 Internal cross references

Directing a user to a different part of a document can be time-consuming and irritating to the user. If the material is not extensive, it is usually better to repeat material than to use a cross reference.

- **10.2.1.4.1 Minimize internal cross referencing.** Internal cross referencing should be minimized. Ways to do this include: (1) repetition of material, (2) sequential organization of the document, and (3) use of foldout pages so that needed material is visible simultaneously with any preceding material.
- **10.2.1.4.2 Form of internal cross references.** Internal cross references shall refer to subdivision or paragraph numbers, or, if numbering is not used, to the title of the subdivision or paragraph. Cross references shall not be made to page numbers.

#### 10.2.1.5 Task versus list orientation

Most user documents will probably be organized to facilitate the performance of one or more tasks. Others might be intended to provide quick access to specific information, and thus might be organized as ordered lists. For some documents, a hybrid of the two organizations might be appropriate (see section 10.5.1).

- **10.2.1.5.1 Task orientation.** If a task orientation is appropriate for a user document, the organization of the document should reflect the steps of the task as determined by a task analysis. If the document covers more than one task, the sequence of coverage should reflect the sequence in which the tasks are performed to the extent possible (see section 10.5.1 for proceduralized instructions).
- **10.2.1.5.2 List orientation.** If a list orientation is appropriate for a user document, the document should be organized in a meaningful way, such as listing the topics in sequential, logical, or alphabetic order.

## 10.2.2 Paragraphs

- **10.2.2.1 Content of paragraphs.** In general, the content of a paragraph should be limited to a single idea. All of the material in the paragraph should relate to and develop that idea.
- **10.2.2.2 Linking sentences.** If text consists of a series of related paragraphs, an individual paragraph should generally include a sentence that links it to the preceding paragraph, the following paragraph, or both. If present, a linking sentence should be either the first or the last sentence of the paragraph.

**Definition.** A **linking sentence** is a sentence that connects the paragraph it is in to the paragraph that precedes or follows it. The connection is usually accomplished by repeating a word or phrase or referring to a concept.

**Example.** Based upon this above definition, a linking sentence is best located at the beginning or ending of the paragraph.

- **10.2.2.3 Topic sentences.** In general, a paragraph should have a topic sentence, that is, a sentence that announces the topic of the paragraph. If present, a topic sentence should follow an initial linking sentence if there is one; otherwise, it should be the first sentence of the paragraph.
- **10.2.2.4 Length of paragraphs.** The average length of paragraphs in technical writing should not exceed six sentences.

**Discussion.** The preferred length of paragraphs is three or four sentences, but five or six sentences is acceptable.

## 10.2.3 Sentences

The ideal sentence states directly what is meant, using familiar words, and without using any excess words; it states explicitly all information that is to be communicated, leaving nothing to be inferred.

### 10.2.3.1 Choice of wording

- **10.2.3.1.1 Clear, simple language.** The text of a document shall be written in clear, simple language, free of vague, ambiguous, unfamiliar, and unnecessary words.
- **10.2.3.1.2 Technical terms.** The text of a document should contain a minimum number of technical terms that require specialized knowledge to be understood unless those terms are needed to convey precise meaning. See section 10.2.4.7 for rules regarding the definition of such terms when they are used.
- **10.2.3.1.3 Nonsexist language.** User documents shall be written using nonsexist, gender neutral language.

#### **Examples.**

(1) the use of human or person rather than an arbitrary man or woman, and (2) the use of he or she rather than the paternal he. Sometimes the use of a generic plural term such as people or they or them will be appropriate.

### 10.2.3.2 Writing level, readability

There are a number of formulas that derive a measure of the readability of text from word difficulty (usually based on word length and familiarity) and sentence complexity (usually based on sentence length). These summary metrics are useful in categorizing and evaluating reading levels of instructional materials. They do not provide specific suggestions to help in the writing of a unique technical document as they are usually calculated after the writing is done. Unfortunately, comprehensibility metrics are not yet available. (See Appendix B for source information on the readability calculations.)

**Discussion.** These summary metrics include the Flesch formula for reading ease, the Dale-Chall formula, the Devereaux formula, The US Army FORECAST readability formula, and the Gunning Fog Index. Readability is usually expressed as a reading grade level. For example, a text might be said to be readable at the eighth grade level.

- **10.2.3.2.1 Writing level.** The writing level of a document should be appropriate to the users of that document. In addition to editorial review, draft review by a user group will provide insight into a document's readability and comprehensibility.

### 10.2.3.3 Length

The typical sentence in user documentation expresses a single thought. The length of the sentence will be whatever is appropriate to the adequate expression of the thought. In some literary styles and subjects, very long sentences that maintain clarity are acceptable.

- **10.2.3.3.1 Average length.** Generally speaking, in technical writing, the length of sentences (without lists) should not, on the average, exceed 20 words.



**Discussion.** The preferred average sentence length is 17 words or less, but up to 20 is acceptable. Shorter sentences are desirable if they express the intended message clearly and completely and comply with grammar rules.

Very long sentences often include lists; these lists can usually be presented vertically, that is, with each item on a separate line, greatly reducing the apparent difficulty of such sentences. Lists are especially appropriate for ordered series of items such as the sequential steps needed to perform a task.

#### 10.2.3.4 Complexity

Complex and compound sentences are more difficult for users to comprehend than are simple sentences.

- **10.2.3.4.1 Single thought.** In general, a sentence should express a single thought.
- **10.2.3.4.2 Subordinate clauses.** A user document should contain relatively few sentences that have more than one or two subordinate clauses. In general, short, simple sentences should be substituted for complex and compound sentences.
- **10.2.3.4.3 Conditional sentences.** If a sentence contains a condition that determines the applicability of the sentence to the reader, the structure of the sentence should permit the reader to decide quickly whether or not the condition is met.

**Discussion.** The preceding sentence is a conditional sentence. Beginning conditional sentences with the word "if" signals the reader that the sentence is conditional. The reader can evaluate the condition and not even read the remainder of the sentence if the condition is not met.

#### 10.2.3.5 Word order

- **10.2.3.5.1 Normal order.** In general, the elements of a sentence should be arranged in the following order: (1) subject, (2) verb, (3) object, (4) predicate object, and (5) indirect object.

**Example.** "Human factors specialists want well-written documentation for the system users."

- **10.2.3.5.2 Chronological.** If a sentence contains two or more items that occur at different times, their order of appearance in the sentence shall match their order of occurrence.

**Examples.** "The war is over but the last shot is yet to be fired" and "The equipment has been returned to service but the paperwork is yet to be completed."

- **10.2.3.5.3 Importance.** In general, the parts of a sentence that are most important should be placed at the beginning or the end of the sentence.

**Examples.** "Inconsistency' is a characteristic that users refuse to tolerate" and "Her mind's eye was captured by the warning sign's stark brevity."

### 10.2.3.6 Voice

- **10.2.3.6.1 Active, not passive voice.** In general, sentences should be written in the active, not the passive voice. That is, the subject acts upon the predicate rather than the more complex arrangement where the subject is acted upon by the predicate.

**Examples.** "Lively sentences move readers" (active) versus "The readers are moved by lively sentences" (passive). Also, "There were many erroneous assumptions in the material" (indefinite and passive) versus "Erroneous assumptions pervade the material" (active).

### 10.2.3.7 Person and mood

- **10.2.3.7.1 Second person imperative.** The second person verb form and the imperative mood shall be used in all sentences that direct the reader to do something. Examples are: "Remove test set from carrying case," and "Turn R15 fully clockwise."
- **10.2.3.7.2 Third person indicative.** The third person verb form and the indicative mood shall be used in descriptions and discussions and in warnings, cautions, and notes. An example is: "When switch A is in the ON position, lamp 34 lights."

### 10.2.3.8 Positive, not negative wording

- **10.2.3.8.1 When to use positive wording.** Most of the time, positively worded sentences should be used because they are more definitive, less confusing, and less evasive than negatively worded statements.

**Examples.** "Often writers will not use negative sentences since these statements may not always be correctly interpreted" (negative) versus "Writers often choose the clarity of the positive over the confusion of the negative" (positive). Consider: "The operator monitoring for errors did not see the alarm nor solve the problem" (negative) versus "The operator failed to see the alarm or to act upon the problem" (positive).

- **10.2.3.8.2 When to use negative wording.** Negative wording should be used to state prohibitions and to correct existing or potential misconceptions.

**Examples.** An example of a prohibition is: "Do not remove the cover until the power cord has been unplugged." An example of correcting a potential misconception is: "The highest voltage is not present in

the largest wire; it is present in the red wire." Also consider: "The alarm display was beyond the visual envelopes of the operators, thus the problem could not be detected by the operational system."

### 10.2.3.9 Standard phrases

- **10.2.3.9.1 Consistent phrases.** The same phrase should be used to express the same meaning throughout a document. For example, the phrase "conforming to" should not be used in one place and "in accordance with" in another if the same meaning is intended.
- **10.2.3.9.2 Task steps.** If a task step occurs more than once in a user document, the same words shall be used in all occurrences, except for any unique variables that need to be included in the different occurrences.

### 10.2.3.10 Capitalization, punctuation, and hyphenation

- **10.2.3.10.1 Capitalization.** The United States Government Printing Office *Style Manual* shall be used as a guide for capitalization. If the *Style Manual* does not provide the guidance needed, Merriam-Webster's *New International Dictionary* shall be used (same as paragraph 8.2.3.1).
- **10.2.3.10.2 Capitalization of phrases for emphasis.** Capitalization shall not be used to emphasize phrases (see section 10.3.3.7 for the recommended way to emphasize text; same as paragraph 8.2.3.2).

**Discussion.** Text other than single words is easiest to read and comprehend when it is presented in mixed case letters. Single words are recognized better when printed in all upper case letters.

- **10.2.3.10.3 Punctuation.** The United States Government Printing Office *Style Manual* shall be used as a guide for punctuation. If the *Style Manual* does not provide the guidance needed, Merriam-Webster's *New International Dictionary* shall be used.

**Discussion.** Punctuation is an aid to accurate reading. Well-planned sentences need little punctuation. If a sentence seems to need extensive punctuation, it may need to be rewritten.

- **10.2.3.10.4 Hyphenation.** The United States Government Printing Office *Style Manual* shall be used as a guide for hyphenation. If the *Style Manual* does not provide the guidance needed, Merriam-Webster's *New International Dictionary* shall be used (see paragraph 10.3.3.4.3).

## 10.2.4 Words and symbols

### 10.2.4.1 Consistency

- **10.2.4.1.1 Terminology.** Technical lexicons should be developed within and between system and subsystems acquisition programs that include common human components (individual users or work groups). This terminology should reflect user inputs and shall be consistently used in system design and in user document development. Consistency of nomenclature, operational, and maintenance terminology is necessary to ensure that human communication is feasible, straight forward, and clear. Lexicon development should be done as early as possible in an acquisition. It is best done before the writing of the user documentation has begun. Terminology should be consistent throughout a user document and among related documents. For example, the name of a part, including any modifying words, should be the same in explanatory text, in procedural steps, and in parts lists.

**Discussion.** Variations in words and phrases, whether they occur intentionally for stylistic reasons or unintentionally through carelessness, incur a strong risk of confusing the reader. Consistent use of words and phrases may incur a slight risk of boredom, but it is not likely to cause confusion. If consistency is ensured in design, it is more likely to be reflected in the documentation. However, inconsistent use of lexicon among design components is likely to result in confusion and increase training burden for the users. This is particularly problematic when standard and accepted practice is not used in NDI or COTS subsystems and components. Such consistency needs to be considered as a criteria in the selection of COTS subsystems and in evaluating its hidden human and monetary costs for operations and maintenance. This consideration argues for closer relationships between the production and selection of user documentation and component selection and design and development.

### 10.2.4.2 Short, high-frequency words

Short, simple, and frequently used words are easier for readers to recognize and comprehend than are long, complex, and infrequently used words.

- **10.2.4.2.1 High-frequency words.** If equivalent high-frequency (familiar) and low-frequency (unfamiliar) words exist for a desired use, the high-frequency word should be used. For example, use would be a better choice than employ.
- **10.2.4.2.2 Short words.** If equivalent short and long words exist for a desired use, the short word should be used. For example, use would be a better choice than utilize.

- **10.2.4.2.3 Simple words.** If equivalent simple and complex words or terms exist for a desired use, the simple word or term should be used.

### 10.2.4.3 Concrete, non-ambiguous words

- **10.2.4.3.1 Concrete versus abstract words.** Concrete words and terms should be used rather than abstract words and terms.

**Examples.** Consider: "Maintenance for this system is poor" (abstract) versus "Maintenance records show that four computer components fail to meet reliability standards and the depot can not repair them. Expensive replacement components remain on back order. The system has been down for three weeks" (concrete).

- **10.2.4.3.2 Ambiguous words.** Ambiguous words and terms shall be avoided.

**Example.** The word replace could mean either "remove an existing item and install a different one" or "reinstall an item." Thus replace by itself is ambiguous and must have additional or different words to make the meaning clear.

- **10.2.4.3.3 Indefinite words and terms.** Indefinite words and terms such as and/or, suitable, appropriate, and etc. should not be used.
- **10.2.4.3.4 Variations on flammable.** The words inflammable and unflammable shall not be used. Flammable shall be used to describe a combustible object, and nonflammable shall be used to describe a noncombustible object.

### 10.2.4.4 Standard verbs

- **10.2.4.4.1 List of standard verbs.** When the definitions apply, the verbs used in instructions to maintainers shall be selected from the list of standard verbs given in Appendix D.

### 10.2.4.5 Other standard words

- **10.2.4.5.1 If, when, and where.** The word if should be used at the beginning of phrases that state conditions in which the passage of time and spatial location are not important, for example, "If a fuse is blown, perform the tests prescribed for the circuit it protects." The word when should be used at the beginning of phrases in which the passage of time is important, for example, "When the motor reaches a speed of 200 RPM, ..." The word where should probably not be used to introduce a conditional phrase unless spatial location is important.

- **10.2.4.5.2 Shall, should, may, and will.** If the sentence structure permits, the word "shall" shall be used in sentences that state something the user must do. The word "should" shall not be used in instructions to maintainers. The word "may" shall be used to express permission or non-mandatory options. The word "will" shall not be used for any of these purposes.

#### 10.2.4.6 Pronouns

- **10.2.4.6.1 Unambiguous referents.** Whenever a pronoun is used, the noun to which it refers shall be clear and unambiguous.

**Example.** The following demonstrates an ambiguous sentence: "Whenever the author knows the reader, he or she benefits." The following statement is clearer: "Whenever the author knows the readers, he or she can write to meet their needs."

#### 10.2.4.7 Definitions

- **10.2.4.7.1 What to define.** Technical terms, uncommon words, and common words that are used in unusual or special ways shall be defined in the text and also in an alphabetically-ordered glossary, if one exists. For example, section 3 of this document provides examples of words and acronyms that need to be defined. Using one such section assists the user in navigating to this reference information.

**Discussion.** In FAA technical document practice, when several (about 10) new terms or abbreviations are used a glossary or, as applicable, a list of acronyms would be included.

- **10.2.4.7.2 When to define.** Words or terms that must be defined shall be defined immediately following their first occurrence in the text.
- **10.2.4.7.3 Repeated definitions.** If a defined word or term occurs in different main divisions of a reference document, the word or term should be defined immediately following its first occurrence in each of the divisions in which it occurs.
- **10.2.4.7.4 Glossary.** Words and terms that are defined in the text shall also be listed alphabetically with their definitions in a glossary.

**Discussion.** To help the reader, the author can highlight words and terms to indicate that they are defined in a glossary or definition section. Also the key technical terms that are need to be defined are placed in the index.

#### 10.2.4.8 Abbreviations and acronyms

The benefit of abbreviations and acronyms is the saving of space; they are shorter, more compact versions of the words or phrases they represent. The cost of abbreviations and acronyms is a reduction in reader comprehension and an increase in reader effort.

**Definitions.** An **abbreviation** is a shortened version of a word or group of words formed by omitting one or more letters. An **acronym** is a word formed from the initial letter or letters of a group of words.

**Examples.** "ft" is an abbreviation of foot and "CAM" is the acronym for Computer-Aided Manufacturing.

- **10.2.4.8.1 Use.** Abbreviations and acronyms shall be kept to a minimum that is appropriate to the technical understanding and usage of the intended users. After its initial definition, an abbreviation or acronym shall be used whenever the term occurs.

**Discussion.** Judgment is necessary to determine the technical understanding and when to use the technical vernacular appropriate to the target users. For example, if a technical document for maintenance personnel used the terms "very high frequency omni-directional radio" and "baby N connector" instead of VOR and BNC, the full names would be inappropriate. The full names may be appropriate for a lay audience, but they would be gibberish and distracting to the target users. There is no substitute for knowing or finding the users.

- **10.2.4.8.2 Definition of abbreviations and acronyms.** Abbreviations and acronyms shall be defined immediately following their first occurrence in the text. Their definitions shall consist of presenting the word or term fully spelled out, followed by the abbreviation or acronym enclosed in parentheses. Examples are: "...abbreviation (abbr)...", and "...Government Printing Office (GPO)...."
- **10.2.4.8.3 Repeated definitions.** If an abbreviation or acronym occurs in different main divisions of a document, the abbreviation or acronym should be defined immediately following its first occurrence in each of the divisions in which it occurs.

**Discussion.** When documents are complex or long enough to warrant divisions, they often are read or reread as reference documents. In these cases, the reader may not read the sections sequentially but will begin with the section or page of interest. Thus, if terms needing definition are defined the initial time they are used in a section, the readers' search for the definition may be reduced to the applicable section rather than throughout the entire document. Including the term's definition in a glossary and, when appropriate, referring to it in the index may assist readers.

- **10.2.4.8.4 Glossary.** The abbreviations and acronyms used in a document shall be listed alphabetically and defined in a glossary.
- **10.2.4.8.5 Standard abbreviations and acronyms.** To the extent possible, abbreviations and acronyms shall be those given in:
  - a. FAA Order 1000.15A, Glossary,
  - b. FAA Order 7340.1H, Contractions, and
  - c. ASME Y1.1, Abbreviations for Use on Drawings and in Text.
- **10.2.4.8.6 Nonstandard abbreviations.** If a word or term to be abbreviated does not appear in any of the sources listed in paragraph 10.2.4.8.5, the word or term should be abbreviated in accordance with the United States Government Printing Office *Style Manual*. In specific specialized technical areas, technical sources, standards, and practice should be followed.

**Discussion.** In certain operating systems, upper and lower case letters can mean different things. For example, *grep*, *Grep*, and *GREP* have a different meaning in the UNIX operating system.

- **10.2.4.8.7 Units of measurement.** The abbreviation and punctuation of units shall conform to ANSI/IEEE Standard 260 for standard letters and symbols for units on measurement. For additional abbreviation guidance conform to the United States Government Printing Office *Style Manual* (see also paragraph 10.2.4.10.1).
- **10.2.4.8.8 e.g. and i.e.** The abbreviations e.g. (*exempli gratia*, meaning for example) and i.e. (*id est*, meaning that is) should not be used.

**Discussion.** Other than academic scholars and perhaps technical writers, few lay audiences or technical audiences understand either the initials or the Latin expressions. "Etc" (and so forth) is more commonly understood but is awkward to many people and was avoided in this document.

### 10.2.4.9 Spelling

- **10.2.4.9.1 Spelling.** The United States Government Printing Office *Style Manual* shall be used as a guide for spelling. If the *Style Manual* does not provide the guidance needed, Merriam Webster's *New International Dictionary* shall be used. In equivalent spelling, the first citation shall be used.



### 10.2.4.10 Numbers

- **10.2.4.10.1 Numerals versus words.** Numbers representing measurements or time shall be expressed in numerals. Numbers (both cardinal and ordinal) representing quantities of 10 or more shall be expressed in numerals; those representing quantities less than 10 shall be expressed in words. If a number is the first word in a sentence, it shall be expressed in words. Other cases and exceptions to these rules shall conform to the United States Government Printing Office *Style Manual*.

**Discussion.** This rule pertains to the decimal (base 10) numbering system, but in specific industry and technical areas other base systems may be used (for example: binary, hexadecimal, and octal systems).

- **10.2.4.10.2 Arabic numerals.** In general, Arabic numerals should be used, not roman numerals.

**Exception.** Roman numerals are recommended for numbering the pages of any front matter a document might contain (see paragraph 10.3.2.6.3).

- **10.2.4.10.3 Decimals versus fractions.** Non-whole numbers should be expressed as decimals, not fractions.
- **10.2.4.10.4 Decimals and leading and trailing zeroes.** Decimals of less than one shall be written with a zero preceding the decimal point. Zeroes following a decimal shall be omitted unless they indicate exact measurement.

### 10.2.4.11 Units of measurement

- **10.2.4.11.1 Dual units.** Both the International System of Units (the Metric system) and the customary inch-pound units of measurement shall be included in text and exhibits. The customary units shall be given first, followed by the International System units in parentheses, for example, 36 in (91 cm). This HFDG document follows the accepted style for metric standards, which places metric values first. The abbreviation and punctuation of units shall conform to ANSI/IEEE Standard 260 and to the United States Government Printing Office *Style Manual* (see also paragraph 10.2.4.8.7).
- **10.2.4.11.2 Conversion of units.** The conversion of units between the International System and the customary inch-pound system shall conform to ANSI/IEEE Standard 268, Metric Practice, and to FED-STD-376.

#### 10.2.4.12 Letter symbols and mathematical signs

- **10.2.4.12.1 Letter symbols and mathematical signs.** Letters used as symbols for objects and mathematical signs shall be in accordance with ANSI Y10.19.

#### 10.2.4.13 Graphic symbols

- **10.2.4.13.1 Standard graphic symbols.** Graphic symbols used for circuit elements shall be those contained in ANSI Y32.2 and ANSI/IEEE 315A with the following additional provisions: 1) in those cases in which ANSI Y32.2 gives different symbols for electronic and electrical elements, the symbols for electronic elements shall be used, 2) under items 4.3.1 to 4.3.3, 4.3.5 to 4.3.7, 4.25.3, and 4.30.2, the parallel line contact symbols shall not be used, and 3) under items 11.2.7 and 11.2.7.1, the circular symbol for indicator lights shall not be used. Designations for electrical diagrams, power switches, and controls shall conform to ANSI Y32.16, Reference Designations for Electrical and Electronic Diagrams and MIL-STD-27A, Designations for Electrical Power Switch Devices and Industrial Control Devices.
- **10.2.4.13.2 Mechanical diagram symbols.** Graphic symbols designating mechanical parts on diagrams and line drawings shall be in accordance with MIL-STD-17B-1 or MIL-STD-17B-2, as applicable.
- **10.2.4.13.3 Logic diagram symbols.** Graphic symbols used in logic diagrams shall be in accordance with ANSI Y32.14. Graphic symbols not listed in ANSI Y32.14 shall not be used without approval of the acquisition program office.

#### 10.2.4.14 Other symbols

- **10.2.4.14.1 Flow chart symbols.** Symbols used in flow charts shall be in accordance with ANSI X3.5.

**Discussion.** Flow chart are seldom used in present software development which use pseudo code and other charts.

- **10.2.4.14.2 Special symbols.** Special symbols used in diagrams shall be explained as follows: 1) if the use of a special symbol is limited to a diagram, the symbol shall be defined in the diagram in which it appears, 2) if special symbols are used extensively, the symbols shall be defined in a chart on a separate page in a section that provides support data, and 3) preexisting charts that define symbols in addition to those that actually appear in the document shall not be used.

## 10.3 Layout and formatting

The most appropriate physical structure for a document depends upon how it will be used. Who will use the document? In what environment will it be used? For what tasks or purposes will it be used? Another important consideration is the handling of updates to the document (see also section 10.5.2 relative to interactive electronic technical manuals).

### 10.3.1 Document-level considerations

#### 10.3.1.1 Size

The optimum size for the pages of a document depends primarily upon the circumstances of its use. For example, a good size for a simple job performance aid might be a size that would fit in a pocket, or a good size for a user's guide to a large, complex system might be 8.5 by 11 inch (21.6 by 27.9 cm) pages.

- **10.3.1.1.1 Basic size.** The basic page size for user documents should be 8.5 inches (21.6 cm) wide by 11 inches (27.9 cm) high. If these pages are trimmed prior to binding, the finished size should be at least 8.25 by 10.75 inches (21.0 by 27.3 cm).
- **10.3.1.1.2 Standard sizes.** For documents of many pages, page size should be selected from the following popular sizes: 1) 8.5 by 11 inches (21.6 by 27.9 cm), 2) 7.25 by 9 inches (18.4 by 22.9 cm), 3) 6 by 9 inches (15.2 by 22.9 cm), and 4) 6 by 8.5 inches (15.2 by 21.6 cm).

**Discussion.** Materials from Europe and Asia tend toward A 4 size or metric paper, 8.27in (21 cm) by 11.69in (29.7cm).

- **10.3.1.1.3 Avoidance of odd sizes.** Odd sizes and shapes should be avoided, for example, pages that are very large or very small, pages that have extreme height-to-width ratios, and pages that are wider than they are high.

#### 10.3.1.2 Binding

The type of binding appropriate for a document depends largely on the user's priorities and on the way in which the document will be used. The primary considerations are whether or not users will want the document to lie flat when opened (see paragraph 10.3.1.2.2) and whether or not individual pages of the document will be removed and new pages inserted (see paragraph 10.3.1.2.3).

**Definitions.** In **mechanical binding**, the pages are punched with either round or slotted holes and then placed in a ring binder or bound with a comb or spiral binder. In **perfect binding**, the pages are assembled, the left side is cut and roughed, glue is applied, and the cover is attached to the pages. In **pamphlet binding**, the pages are stitched or stapled together. There are two types of

pamphlet binding, saddle stitched and side stitched.

**Saddle stitching** permits the document to lie flat

- **10.3.1.2.1 Page orientation.** Unless special considerations warrant a different orientation, pages should be bound at the left side, not at the top.
- **10.3.1.2.2 Flat-lying.** The binding should permit the document to lie flat when it is open.

**Discussion.** Ring binders and comb or spiral binding are probably the best choices in this respect for large documents; saddle stitching, for small documents. Spiral and comb bindings are cheaper; ring binders permit easy access for copying as well as updates.

- **10.3.1.2.3 Easy updating.** If it is likely that a document will be updated frequently, a ring binder should probably be selected.

## 10.3.2 Page-level considerations

It is desirable that the visual structure of a document, that is, its cues and format, is reflected and complemented by the structure in the table of contents. The primary objective of the text designer is to create a visual hierarchy that distinguishes major concepts from sub-concepts and one category of information from another. Ways to do this include varying the size of type and the position of the material on the page. Visual cues are most effective when used sparingly.

### 10.3.2.1 Margins

- **10.3.2.1.1 Consistency.** Margins shall be consistent throughout a document, or, conversely, the portion of the page used to present information shall be consistent.
- **10.3.2.1.2 Pages 8.5 by 11 inches (21.6 by 27.9 cm) or larger.** On pages 8.5 by 11 inches (21.6 by 27.9 cm) or larger, the margins shall be at least 1 inch (2.54 cm) on all sides.

**Discussion.** This margin recommendation permits room for binding or for punched holes for loose leaf ring binders on all pages without the necessity of special or offset margins for reference documents. FAA Order 1320.1.D sets the text line presentation area as 7 in (18.8 cm) width for directives. FAA-D-2494 (for instruction books with right and left hand pages) sets margins at .75 in (1.9 cm) on the outside edges and 1 in (2.5 cm) on the inside edges as margins for instruction books.

- **10.3.2.1.3 Pages smaller than 8.5 by 11 inches (21.6 by 27.9 cm).** On pages smaller than 8.5 by 11 inches (21.6 by 27.9 cm), the minimum size of the margins should be decreased in proportion to the ratio of the longer dimension to 11 inches (27.9 cm). For example, if the page size is 6 by 9 inches (15.2 by 22.9 cm), the margins should be reduced by the ratio of 9 to 11, so that the minimum margin size is 0.82 inches (2.1 cm).

Exhibit 10.3.2.1.3 presents the margin rules that are stated in paragraphs 10.3.2.1.2 through 10.3.2.1.4.

**Exhibit 10.3.2.1.3** Margin sizes for standard paper sizes

	Paper size		Margins on all sides	If offset for binding, add the following to the left margin and subtract from right margin
	width	length		
in (cm)	8.5 (21.6)	11 (27.9)	1 (2.5)	.5 (1.3)
in (cm)	7.25 (18.4)	9 (22.9)	.82 (2.1)	.42 (1.1)
in (cm)	6 (15.2)	9 (22.9)	.82 (2.1)	.35 (.9)
in (cm)	6 (15.2)	8.5 (21.6)	.77 (2.0)	.35 (.9)

- **10.3.2.1.4 Offset for binding.** If the pages are to be bound on the left, the left margin shall be increased by 0.5 inch (1.3 cm) for 8.5 by 11 inch (21.6 by 27.9 cm) pages or by an amount proportional to the ratio of the page width to 8.5 inches (21.6 cm) for pages of other sizes.

### 10.3.2.2 Headers and footers

Page headers and footers can be used to present a variety of potentially useful information to the reader, for example, page numbers, the name of the section and possibly also the subsection of the document, and the date of issue of the page or document.

- **10.3.2.2.1 Location information.** Information that helps a reader know where he or she is in the document should be included in a header or footer on every page.
- **10.3.2.2.2 Use of headers and footers.** If only a few elements of information are to be presented, they should probably be presented in a header only; that is, a footer should be omitted. If more elements are to be presented than fit comfortably in a header, then the information should be divided between a header and a footer.
- **10.3.2.2.3 Location of information within a header or footer.** The elements of information included in headers and footers should be located in accordance with their importance to the reader. The most important elements should be located at the outside ends. The next most important elements should be located either centered or near the outside end of the header or footer. The least important information should be presented at the inside end.

**Example.** In this document, there are five elements of information in headers and footers: document identification number, the name of the major division, the date of issue, the name of the major subdivision, and the page number. The two elements that are most useful in letting a user know where he or she is in the document, the page number and the name of the major subdivision, are located at the outside edge and adjacent to the outside edge, respectively.

- **10.3.2.2.4 Headers, footers, and margins.** Headers and footers should be located within the space reserved for top and bottom margins, that is, they should not take space away from that reserved for the body of the document.

### 10.3.2.3 White space

The spatial formatting of text can be extremely effective in communicating the structural hierarchy of information. The consistent and logical allocation of vertical and horizontal white space creates a visual hierarchy that separates major headings from minor headings, headings from text, and so forth. The judicious use of spacing can convey information about the structure of a document to users more easily and effectively than can typographic cues. White space can be used in combination with typographical cues. Reduced line lengths and associated horizontal white space can make skimming, searching, and reading easier.

- **10.3.2.3.1 Representational vertical spacing.** The vertical space that precedes a text element should indicate that element's level in the document's structural hierarchy, with the amount of space increasing at each level.

**Example.** A logical point to start in determining vertical spacing is the smallest vertical unit, the space between two lines of text. If this space is taken to be one unit of spacing, the resulting representational spacing might be two units between paragraphs, four units between a subheading and a paragraph, and eight units between a major heading and a subheading. This document uses vertical white space to set off text paragraphs in the right-hand text columns. In the left column, white space combines with typographical cues to differentiate subsection heading levels.

- **10.3.2.3.2 Horizontal spacing (indentation).** Horizontal spacing, indentation, is an alternative to vertical spacing as a means for showing the hierarchical structure of a document. If horizontal spacing is used, the left-most position should represent the highest level of the hierarchy, with subsequent indentations representing successively lower levels. This document illustrates using horizontal white space to distinguish between subsection headings and text paragraphs which include introductory text and rules. Rules are further identified with marking, numbering, and typographical cues. Finally, supplementary information (such as definitions, examples, notes, and discussions) is set aside by an additional horizontal indentation.

**Discussion.** Horizontal spacing is not as straightforward as vertical in indicating hierarchical levels. While successive indentation would seem to imply successively lower hierarchical levels, readers perceive centered headings to be more important than headings at the left margin.

### 10.3.2.4 Paragraphs

- **10.3.2.4.1 Indentation of first line.** If either of the vertical or horizontal spacing formats recommended in section 10.3.2.3 is used, the first lines of paragraphs should not be indented.

### 10.3.2.5 Right- and left-hand pages

The printing of pages on both sides introduces the possibility -- and desirability -- of treating the fronts of pages differently from the backs. If offsets for binding are necessary, left- and right-hand pages will have different margins (see paragraph 10.3.2.1.4).

**Examples:** One uses distinctive right and left pages to consistently locate (location coding) header and footer information as an aid to users in navigating through the pages of the document. In this document, for instance, the section title in the headers and the page number and subsection level number in the footers appear on the outside edges of both the right-hand and left-hand pages. These aid the user in page search and finding or maintaining one's place in the document.

**Definitions.** The terms right-hand page and left-hand page have meaning only if pages are printed on both sides. In that case, a right-hand page is the page printed on the front, and a left-hand page is the page printed on the back. Thus, when the pages are bound, and the document is open, the right-hand page appears on the right, and the left-hand page appears on the left.

- **10.3.2.5.1 Major divisions of the document.** Major divisions of the document should begin on right-hand pages. This will occasionally result in a blank left-hand page.

**Discussion.** In large frequently-used reference documents with many pages and divisions, one consistently begins each new major division on a right-hand odd-numbered page. This practice permits one to number pages within each section and to insert tabs between sections as is done in this document (see also section 10.3.2.6).

- **10.3.2.5.2 Page numbering of left and right handed pages.** Right-hand pages shall be odd-numbered pages, and left-hand pages shall be even-numbered pages.

### 10.3.2.6 Page numbering

There are two common methods for numbering the pages in a document, 1) numbering the pages sequentially from the beginning to the end of the document, and 2) numbering the pages independently within each major division of the document.

This second method incorporates a designation for the division into the page number, for example, 3-9 would be the number of the ninth page of the third division.

**Discussion.** Numbering within divisions has two advantages: 1) it provides the reader with an additional location cue as to which division one is looking at, and 2) it makes updating easier in that fewer pages need be renumbered when material is added or deleted.

- **10.3.2.6.1 Arabic numerals.** Arabic numerals shall be used for the page numbers of the main body of a document.
- **10.3.2.6.2 Numbering style -- body.** The page numbering style for the main body of documents containing three or more major divisions or having an average division length of six or more pages should be the division designation followed by a dash followed by the number of the page within the division, for example, 4-7 is the divisional page number of the seventh page of the fourth division.
- **10.3.2.6.3 Numbering style -- front material.** The pages of material at the beginning of a document, such as a foreword or a table of contents, should be numbered sequentially with lower case roman numerals.
- **10.3.2.6.4 Numbering style -- Appendixes.** Appendixes should be designated using consecutive letters beginning with A. Pages within an appendix should be numbered using the designation of the appendix followed by a dash followed by the sequential number of the page within the appendix, for example, A-3 would be the third page of Appendix A.
- **10.3.2.6.5 Location.** If compatible with other information displayed in headers and footers, page numbers shall be located at the bottom outside edge of the page, that is, at the right edge of right-hand pages and the left edge of left-hand pages.

### 10.3.2.7 Columns

- **10.3.2.7.1 Number of columns.** The number of columns of text on a page of user documentation shall not exceed two.

**Discussion.** The use of columns may seem to complicate word processing in certain software packages. However, the benefits of location coding permitted by appropriate white space to the user navigation and readability warrant consideration of columns from a human factors usability standpoint.

- **10.3.2.7.2 White space in columns.** If a two-column format is used for a user document, the proportional vertical spacing method of revealing the structural hierarchy should probably be used. Column width less than 5 inches can make scanning for information easier (see also paragraphs 10.3.2.3.1 and 10.3.2.3.2).



**Discussion.** Since the division of the page into two columns halves the horizontal distance available for successive levels of indentation without affecting the vertical space available, the vertical spacing method will usually work more effectively than the horizontal.

- **10.3.2.7.3 Column width.** The relative width of the columns in a two-column format depends upon the nature of the columns. If the text is simply presented in two columns, the columns should be of equal width. If the left-hand column is used for headings, as in this document, the left-hand column should be narrower than the right-hand column.

### 10.3.2.8 Foldout pages

Foldout pages are relatively expensive to produce and relatively difficult to handle. Still, there are advantages to their use; in particular, the larger size may be necessary to display detail legibly. They can also permit a drawing or table to be visible while the user looks at other parts of the document.

- **10.3.2.8.1 Minimize use.** The use of foldout pages should be minimized to those necessary to legible display of the information and necessary to understanding and tracing location and relational information.

**Discussion.** One way to reduce their use is to divide a large figure or table and display it on facing pages rather than printing it on an oversize page. When facing pages or fold out pages are used it may be necessary to aid the reader in tracing lines across the gaps or folds. For instance, when a large number of parallel lines transition across folds or gap, color coding of each continuing line may help a user trace and maintain the identity of the lines. Giving lines number or letter identifiers at places throughout each line may help.

- **10.3.2.8.2 Foldout to the right.** Foldout pages shall fold to the right only; they shall not fold out to the top or bottom.
- **10.3.2.8.3 Right-hand pages.** Foldout pages should be printed on the front (right-hand side) of the page only.
- **10.3.2.8.4 Visibility of page number and caption.** Each foldout page shall be folded so that the page number and the page caption are visible without unfolding.
- **10.3.2.8.5 Visibility of entire exhibit.** If it is necessary that a user see an entire exhibit while reading another part of the document, the exhibit shall be printed with a blank area the size of a normal page at the left of the foldout page so that when the page is unfolded, the entire exhibit will be visible.
- **10.3.2.8.6 Location of foldout pages.** If the ratio of text to foldout pages is reasonably balanced, a foldout page should be the next page after the one on which it is mentioned. If doing this would result in an excessive amount of white space on text

pages, the foldout pages should be grouped together in a single section immediately preceding any appendixes.

- **10.3.2.8.7 Foldout pages as a separate series.** If foldout pages are grouped together and placed near the end of a document, and if the document contains other figures or exhibits that do not appear on foldout pages, the foldout exhibits shall constitute a separate series of exhibits and shall be identified and numbered accordingly.

**Discussion.** If a document contains both foldout and non-foldout exhibits of the same type and the foldout exhibits are grouped at the end of the document, users may have difficulty finding a particular exhibit. Treating the foldout exhibits as a separate category of exhibits will help alleviate the difficulty. For example, exhibits that are integrated into the text might be called "exhibits" and oversized exhibits that are grouped at the end might be called "foldouts."

### 10.3.3 Typographic issues

Typographic cues are useful for conveying to readers the importance and organization of textual material. Type size is easily the most important cue. The position of material such as headings is another potential cue, as is the use of all capital letters. The use of color and varied intensity (boldness) of printing are additional potential cues.

**Definition.** A point is a measure of the height of type; there are 72 points in an inch (2.54 cm).

#### 10.3.3.1 Type size

- **10.3.3.1.1 Basic size.** The basic size for text should be 10 point type. If the document will be used under dim illumination, the size should be increased to 11 or 12 points.

**Discussion.** This guideline assumes that the document will be composed and reproduced with good quality equipment resulting in sharp, clear images, and that it will be viewed under satisfactory conditions, including illumination, reading distance, and viewing angle.

**Examples.** The text of this document is 12 point type. Newspaper text is 10 point. Eight point type is often used in car advertisements. Smaller sizes are used in phone book listings and tabular materials.

- **10.3.3.1.2 Minimum size.** The minimum size for text should be 8 point type. This size should be used only when viewing conditions, particularly illumination, are satisfactory.

**Example.** The text in the exhibits in this document is 10 point type.

- **10.3.3.1.3 Unequal spacing of sizes.** If more than two type sizes are used to indicate the importance of material, for example, the

level of a heading, the difference in size from one level to the next should increase as the size of the type increases; that is, the differences should not be equal.

**Example.** If three type sizes are used to indicate three levels of headings, the smallest size might be 12 points; the middle size, 14 points; and the largest size, 18 points, rather than sizes of 12, 14, and 16 points. In this example, the difference in size is doubled at each step.

- **10.3.3.1.4 Number of different sizes.** The number of different sizes of type used should not exceed four.

**Discussion.** The reason for using different sizes of type is to convey information to the user, usually information about the hierarchical location of the text. If too many different sizes are used, they can become indistinguishable from one another and confuse rather than help the user.

### 10.3.3.2 Line length

Most readers prefer line lengths within the range of 14 to 36 picas for type sizes in the range of 8 to 12 points, and lines varying within this range are approximately equal in legibility.

**Definition.** A pica is the unit of measurement used in printing. It is equal to 0.17 inch (4.23 mm).

- **10.3.3.2.1 Line length.** For type sizes in the range of 8 to 12 points, line length should not be less than 14 picas or more than 36 picas.

**Discussion.** Lines longer than 36 picas become increasingly difficult to read.

### 10.3.3.3 Line spacing

- **10.3.3.3.1 Minimum spacing.** The spacing between lines using type sizes in the range of 8 to 12 points should be at least two points.

**Discussion.** If the space between lines is too small, reading difficulty is increased.

### 10.3.3.4 Justification

The alignment of the starting point of lines of text is generally agreed to aid reading, probably by providing a predictable place for the eye to move to. Most typeset text and much of the text produced with word processors incorporates variable spacing within and between words so that lines are of equal length and the right ends of the lines are also aligned. In addition to variable spacing, words are often broken (hyphenated) in the process of constructing equal length lines. There is no evidence that the use of equal length lines aids reading, however, hyphenation can cause reading difficulties.

**Definitions.** In left-justified text, lines of text are aligned at the left, but spacing within and between words is not varied, resulting in a ragged right margin. In right-

justified text, lines of text are aligned at the right, but spacing within and between words is not varied, resulting in a ragged left margin. In center-justified text, lines are centered on the page, with both right and left margins ragged. In fully-justified text, spacing is added within and between words so that all lines are the same length, resulting in alignment of both right and left margins.

- **10.3.3.4.1 Justification of text.** For extended text, the type of justification used should be either left- or full-justification. Center- and right-justification should not be used for text.
- **10.3.3.4.2 Appropriate use of right-justification.** If right-justification is used, its use should be restricted to such items as headings and information in headers and footers.
- **10.3.3.4.3 Avoiding hyphenation.** The breaking of words between syllables at the ends of lines should be avoided. The only hyphens at the ends of lines of text should be those that properly signify compound words (see paragraph 10.2.3.10.4).

### 10.3.3.5 Type style (font)

Most type fonts fall into one of two categories, those having serifs and those that do not (sans serif fonts). Readers seem to prefer fonts with serifs and seem to read them more easily.

**Definitions.** Serifs are decorative elements (short lines, knobs, and balls) at the ends of the strokes that form letters. Sans serif fonts do not have these decorative elements. A type family is a collection of fonts that are similar in design but vary in size and boldness.

**Discussion.** By far the majority of books and newspapers (and this document) use fonts with serifs. Helvetica and Univers are common sans serif fonts. (This is Univers type.) The text within exhibits in this guide is a sans serif font. A family can include *italic* versions.

- **10.3.3.5.1 Serifs for basic font.** The basic font for a document should be a font that has serifs.
- **10.3.3.5.2 Minimize different fonts.** The number of different fonts used in a document should be kept to a minimum.

**Discussion.** One family of fonts can be used for text, including different sizes of type, boldface fonts, and italic fonts. Another family might be used to make another type of information stand out from the basic text. For example, in this document, information in exhibits is presented in Univers, a sans serif font.

### 10.3.3.6 Upper versus mixed case text

Text that is written using both upper and lower case letters is both preferred by users and more legible to them. In the case of isolated letters and words, however, capital letters are more legible than lower case letters. Logically this implies that all text, including titles, headings, headers, and footers, would best be printed in mixed case. However, the use of all upper case

letters can make individual words stand out and thus aid comprehension.

- **10.3.3.6.1 When to use upper case letters.** Upper case letters shall be used in accordance with the rules for capitalization contained in the United States Government Printing Office *Style Manual*.
- **10.3.3.6.2 Words to be typed in upper case letters.** If the following words are used as headings, they shall be displayed in all upper case letters: 1) WARNING, 2) CAUTION, and 3) NOTE.
- **10.3.3.6.3 Minimize use of upper case letters.** The use of upper case letters for words and phrases in text should be minimized; upper case letters should not be used to emphasize a word or phrase.

### 10.3.3.7 Typographic emphasis

There are a variety of ways in which portions of text can be emphasized typographically. The use of upper case letters has already been discussed. Other commonly-used ways include: 1) the use of **boldface** type, 2) the use of *italic* type, and 3) the use of underlining. The intent of all of these is to make a portion of text stand out from its surroundings.

Judicious use of typographic emphasis can help readers locate and remember things, but emphasis is probably most effective when it is used sparingly. For emphasis to be effective, the reader must 1) be aware of the intent of the emphasis, and 2) know enough about the task to judge the importance of the emphasized words.

- **10.3.3.7.1 Inform the reader.** If typographic emphasis is used, the reader shall be informed of what it is and what it means.
- **10.3.3.7.2 Use boldface type for emphasis.** If typographic emphasis is used, it shall be boldface type.
- **10.3.3.7.3 Use typographic emphasis sparingly.** Typographic emphasis shall be used sparingly.
- **10.3.3.7.4 Do not use underlining for emphasis.** Underlining should not be used for typographic emphasis.

**Discussion.** Underlining actually makes the underlined text more difficult to read, at least for some readers; it reduces the white space between lines, and it disrupts the characteristic shape of the underlined word or words. The same is true for numbers (see also paragraph 10.3.3.7.6).

Sometimes underlining is used to indicate changes in a document. Other typographical cues such as redlining, asterisks, or vertical lines in the margin may be used to indicate changes. FAA order 1320.1D calls for the use of asterisks or vertical lines in the margins to indicate

change. Whatever the method, the notation for change should be explained in the text. In a directive, it is explained in a paragraph entitled explanation of changes.

- **10.3.3.7.5 Do not use italics for emphasis.** Italic type shall not be used for typographic emphasis.

**Discussion.** Italic type fonts are usually drawn with relatively thin lines, which tend to make these fonts recede rather than stand out from the surrounding text. This is the opposite of emphasis. Italic type is appropriate for the titles of books when they appear in text and in bibliographic references.

- **10.3.3.7.6 Do not use upper case letters for emphasis.** All upper case letters should not be used for typographic emphasis in text.

**Discussion.** The use of all upper case letters in text slows reading and appears to interfere with memory of the unemphasized material. Individual words can be recognized faster when they appear in upper case letters, so, if used sparingly and wisely, upper case letters can be effective for emphasis. However, because boldface type has fewer actual and potential problems, it seems a better choice for typographic emphasis. FAA Order 1320.1D addresses the use of underlining and capital letters when standard typewriting is used for document preparation. It also notes that word processing equipment offers bold and other typographical cues which, when appropriately used, enhance reading and navigation in a document.

- **10.3.3.7.7 Do not use quotation marks for emphasis.** These marks are for direct quotation of a source or for words particular to the subject matter where special distinction is necessary for clarity. Quotation marks shall not be used for emphasis of text or to enclose titles or headings.

### 10.3.3.8 Print contrast, quality

Typesetting and competent offset printing produce print of adequate quality for documents that may be used in a range of viewing conditions. Modern laser printers can also produce print of this quality. Mechanical or dot matrix printers generally do not produce print of this quality.

**Definition.** Print contrast is the ratio of the difference in brightness between the printing and its background to the brightness of the background (assuming dark print on a light background). It is defined by  $(B1-B2)/B1$ , where B1 is the brighter of the two.

- **10.3.3.8.1 Adequate print contrast.** The print contrast of a document shall be high enough so that users can read it without eyestrain under the expected viewing conditions.

### 10.3.3.9 Color and shading

Color can be a very effective cue, especially when it is used to aid users who are searching for something. However, users perceive color as less significant than other types of typographic cuing, particularly size and boldness. In addition, the existence of deficiencies in the color vision of some users limits the applicability of color as an effective cue.

- **10.3.3.9.1 Color as a typographic cue.** If color is used as a typographic cue, it shall be redundant with another typographic cue, such as size.
- **10.3.3.9.2 Text in color.** If color is used for either print or background, it shall satisfy the print contrast criterion, paragraph 10.3.3.8.1.
- **10.3.3.9.3 Subsequent reproduction.** If a document is likely to be photocopied, colors and shadings shall be selected so that their meanings do not become lost or distorted when photocopied.

**Discussion.** Colors that are clearly different in their original reproduction may change during photocopying in black and white in ways that change their meaning. For example, the lighter of two colors may become the darker of two shades of gray. Similarly, gradients of colors or shadings that are clear in the original production may be lost in photocopying.

## 10.4 Components of documents

This section contains criteria and guidelines for the various components that might be contained in a user document, such as the cover page, table of contents, and figures. Exhibit 10.4 lists FAA directives associated with certain types of documents that are oriented to FAA users and lists the components and the sequence for components, when applicable for each type. These directives and related specifications listed in Exhibit 10.4 also call for mandatory items: forms to identify and control changes and some explicitly required paragraphs and text. These mandatory policies are to be followed for each applicable type of document.

**Discussion.** FAA Order 1320.1D addresses directives in general and includes long orders (more than 25 pages) which may be called handbooks. The order describes the orders development process and prescribes some formal formatting details for organizational-level orders or supplements. FAA Order 1320.58 addresses Maintenance Technical Handbooks and equipment modification directives. These are exempted from 1320.1D formatting provisions.

There are two kinds of user oriented documents that apply to the implementation of specific modification programs: modification manuals and modification instructions. The manuals are to have similar components to those listed in the exhibit under Maintenance Technical Handbooks. When either of these modification program documents are

Exhibit 10.4 FAA directives and order of document components

Source	FAA Order 1320.1D	FAA Order 1320.58	FAA Specification FAA-D-2494/b Appendix 1	
Document types	Generic Long Orders	Maintenance Technical Handbooks, Modification Manuals	Technical Instruction Books	Commercial Instruction Book Contents
Document components	& Instructions			
Cover	x	x	x	
Contractor guarantee			x	
List of modifications to specifications (drafts only)			x	
List of effective pages			x	
Content assurance page			x	
Record or order of changes	x	x	x	
Foreword	x	x	x	
Table of contents	x <del>table</del>	x	x	
List of tables		x	x <del>table</del>	
List of illustrations, figures		x	x <del>table</del>	
Family tree chart			x	
General information and requirements	x	x	x	x
Technical characteristics or description		x	x	x
Operations			x	x
Standards and tolerances		x	x	x
Periodic maintenance		x	x	x
Maintenance procedures		x	x	x
Corrective maintenance			x	x
Flight inspection		x		
Parts list			x	x
Installation and checkout			x	x
Computer software			x	x
Troubleshooting			x	x
Miscellaneous	x			
Appendixes	x	x	x	
Glossary	x	x		
Index	x	x	x	
Feedback	x	x	x	



manufacturer's documents, they may be treated as technical issuances as is explained later.

FAA-D-2494/b addresses instruction books for operation and maintenance of new or modified systems and equipment. With FAA permission, instruction books may also be technical issuances. In such cases, writers and publishers may use other formats and organizations. FAA-D-2494 includes an appendix that addresses a general evaluation of commercial instruction books.

**Definition.** Technical Issuances, according to FAA Order 1320.1D, are publications acquired from non-agency sources or developed within FAA that directly concern installation, maintenance, or modification of equipment, equipment systems, facilities, or aircraft. Manufacturers' instruction books for plants and equipment are included in this category. A basic objective of using this category is to permit the merging of internally-developed and externally-acquired technical manuals and publications into consolidated, single source documents. Because of necessary deviations from standard directive format and issuance procedures, they are designated technical issuances.

The detailed guidance of this user-interface guide represents advisable practice to help design-in and facilitate human performance as a component of new or changed operational systems. Its provisions may be selectively applied to user-documentation of new and modified systems. It may be used to help evaluate user documentation on NDI and COTS procurements.

## 10.4.1 Cover page

- **10.4.1.1 Contents of cover page.** The cover page of a user document shall contain the explicit identifying information for the document including a document title, number, and date.

**Example.** An instruction book cover has the following elements: 1) the national stock number of the document, 2) the publication number, 3) a phrase specifying the type of document, for example User's Guide, 4) the name of the equipment or system to which the document applies, 5) if applicable, "TYPE" and the type number of the equipment or system, 6) if applicable, "SERIAL NOS." and the range of serial numbers to which the document applies, 7) "U.S. DEPARTMENT OF TRANSPORTATION," and 8) "FEDERAL AVIATION ADMINISTRATION."

- **10.4.1.2 Type style and size, 8.5 by 11 inch (21.6 by 27.9 cm) pages.** The type style used on the cover page shall be bold, and it shall not be italic. The point size for each element for an instruction book is given in Exhibit 10.4.1.2.

**Exhibit 10.4.1.2** Type sizes for cover page elements

<b>Element</b>	<b>Point size</b>
National stock number	14
Publication number	14
Type of document	18
Name of equipment or system	30
"TYPE" and type number	18
"SERIAL NOS." and serial numbers	18
"U.S. DEPT. OF TRANSPORTATION"	18
"FED. AVIATION ADMINISTRATION"	14
All other printing	12

- **10.4.1.3 Type family.** The type used on the cover page of a document should be a member of the type family used for the basic text.
- **10.4.1.4 Type size, other than 8.5 by 11 inch (21.6 by 27.9 cm) pages.** If the page size of a document is less than 8.5 by 11 inches (21.6 by 27.9 cm), the point size of the type used on the cover page should be reduced by the ratio of the page width to 8.5 (21.6 cm) inches. For example, if the page size is 6 by 9 inches (15.2 by 22.9 cm), the type size should be reduced by the ratio 6:8.5, or to 71 percent of its original size.

## 10.4.2 Table of contents

A table of contents serves to reveal the organization of a document as well as to guide the user to a desired topic.

- **10.4.2.1 When to include a table of contents.** A user document shall have a table of contents unless it has fewer than three divisions or fewer than six pages (see also paragraph 10.1.2.3).
- **10.4.2.2 Labeling the table of contents.** The single word "CONTENTS" shall appear at the beginning of the table of contents.
- **10.4.2.3 What to include in the table of contents.** A table of contents shall include: 1) at least two levels of the headings and subheadings of the document, 2) appendixes if they exist, 3) the glossary and index if they exist, 4) lists of exhibits, illustrations, figures, and tables if they exist, and 5) the initial page number of each item listed.
- **10.4.2.4 Right-hand page.** The table of contents shall begin on a right-hand page.

### 10.4.3 Lists of exhibits

Lists of exhibits (figures, tables, or any other illustrations) may follow or may be part of the table of contents; this section contains additional criteria and guidelines pertaining to lists.

**Discussion.** In this guide, exhibits which contain either or both graphics and tabular materials are used. Such exhibits enable the user to have the graphic and tabular data that are used together, located together. This practice aids the user's task performance by eliminating cross referencing between separate table and figure information.

- **10.4.3.1 When to use lists of exhibits.** If a document contains one or more instances of a type of exhibit, such as a figure or table, all instances shall be listed by type in the table of contents. That is, all figures shall be listed in a list of figures, and all tables shall be listed in a list of tables.
- **10.4.3.2 Contents of lists of exhibits.** Lists of exhibits shall include: 1) the identification of the exhibit, for example, "Exhibit 6-1," 2) the title of the exhibit, and 3) the page number on which the exhibit appears or begins.
- **10.4.3.3 Location and precedence of lists.** Lists of exhibits shall be placed at the end of the table of contents. Each type of exhibit shall be listed separately, and the lists shall be placed in the following order: 1) exhibits labeled "exhibit," 2) figures (or other types of illustration), 3) foldout figures, 4) tables, and 5) foldout tables.

### 10.4.4 Figures

This section contains criteria and guidelines for the use, identification, location, style, content, and orientation of figures.

**Definition.** A figure is an exhibit that is primarily graphical or pictorial in nature, as opposed to verbal or numerical.

#### 10.4.4.1 General

- **10.4.4.1.1 When to use.** Figures shall be used when they are likely to increase a reader's understanding in ways that words cannot.
- **10.4.4.1.2 Relationship to text.** Figures shall be clearly related to, consistent with, and referred to in the text of the document.

#### 10.4.4.2 Identification

- **10.4.4.2.1 Number and title.** Each figure shall have a unique identifying number and a title. Numbers shall be assigned consecutively, beginning with one, either for the document as a whole, or within divisions. If they are assigned within divisions, the division's identifying number shall form part of the figure's identifying number. The figure's title shall describe concisely what the figure contains.

**Examples.** Figure 3-2 would indicate the second figure in the third major division of a document. In this

document, the identifying number of an exhibit contains the number of the paragraph to which it applies.

- **10.4.4.2.2 Caption.** Each figure shall have a caption that consists of the word "Figure" followed by its unique identifying number, two spaces, and its title. The caption shall be centered below the figure.

### 10.4.4.3 Location

- **10.4.4.3.1 Figure follows reference.** Figures shall follow, not precede, their first reference in the text (same as paragraph 10.4.5.3.1 for tables).
- **10.4.4.3.2 Preferred location.** A figure that is smaller than a page should be placed on the same page as its first reference, either within or following the paragraph that contains the reference. If the space following the reference is too small, the figure should be located at the top of the following page. A figure that fills a page should be placed on the page following the page containing its reference (same as paragraph 10.4.5.3.2 for tables).
- **10.4.4.3.3 Consistent location.** The relative location of a figure to its first reference in the text should be consistent. If for some reason the preferred location specified in paragraph 10.4.4.3.2 is not satisfactory, all the figures should be grouped together near the end of the document. An example of this would be a document in which the space devoted to figures far exceeds the space devoted to text (same as paragraph 10.4.5.3.3 for tables).

### 10.4.4.4 Style

- **10.4.4.4.1 Consistent style.** The figures for a document shall be prepared so that in their final state, that is, after any reduction or enlargement, they are consistent in terms of such characteristics as line width, shading, and style and size of type.
- **10.4.4.4.2 Preferred pictorial style.** Pictorial figures should consist of line drawings rather than photographs.

**Discussion.** While there may be circumstances in which photographs might be preferable, in general, line drawings have several advantages. In particular, they permit omission of distracting and irrelevant details, and they can be reproduced without significant loss of detail.

- **10.4.4.4.3 Consistent pictorial style.** All the comparable figures in a document should be prepared in the same style, for example, all line drawings, or all photographs.
- **10.4.4.4.4 Minimal distraction.** Decorative elements such as borders and background shading shall be avoided. Photographs shall be cropped or masked to remove irrelevant or unimportant portions unless those portions are helpful in orienting the reader. Photo masking with high reproducible quality may be an economical alternative to line drawings.

- **10.4.4.4.5 Alphanumeric information.** All alphanumeric information contained in figures shall be created mechanically or electronically; it shall not be hand drawn. The size shall be at least 8 points in the figure's final size, that is, after any reduction or enlargement.
- **10.4.4.4.6 Line width.** The width of lines when the figure is in its final size, that is, after reduction or enlargement, shall be at least 0.01 inch (0.25 mm).
- **10.4.4.4.7 Color.** Color shall not be used in figures unless it is meaningful and authorized by the acquisition program office.

**Discussion.** The use of shadings and patterns is usually as effective as the use of color.

#### 10.4.4.5 Content

- **10.4.4.5.1 Amount of detail.** Figures shall contain only necessary and useful detail, that is, they shall contain the detail necessary to the task being performed and additional detail that provides helpful context.
- **10.4.4.5.2 Callouts.** Specific features of interest in a figure shall be identified with callouts. The text of a callout may be located adjacent to the feature, or the feature may be identified by a number, and the text located elsewhere. A callout shall consist of: 1) an arrow with its head pointing at the feature and its tail leading to a block of text or to a number, 2) a number that is keyed to a block of text, if applicable, and 3) a block of text that gives information about the feature. Numbered callouts shall be numbered consecutively, starting with one and beginning with the feature nearest "three o'clock" on the figure and proceeding clockwise around the figure.
- **10.4.4.5.3 Specific types of diagrams.** If a document contains any of the following specific types of diagrams, the diagrams shall conform to FAA-D-2494/b: 1) block diagrams, 2) major function diagrams, 3) schematic diagrams, 4) diagrams for analog equipment, 5) diagrams for functional entities, 6) functional circuit diagrams, 7) photographs, 8) continuous-tone illustrations, 9) printed circuit board illustrations, 10) power distribution diagrams, 11) wiring diagrams, 12) cabling diagrams, 13) mechanical drawings, and 14) piping diagrams.

For developing directives, FAA 1320.1D recommends that figures which are sample forms should be a filled out as an example to help the user. Rather than dividing form filling instructions between the figure and the main text or an appendix, the writer should include instructions on the sample form and, where feasible, show variances for completion in marginal notes.

#### 10.4.4.6 Orientation

- **10.4.4.6.1 Preferred orientation.** Figures should be oriented so that the reader can read them without rotating the page, that is,

all text, including the figure's identification and title, should appear horizontally when the page is in its normal orientation (same as paragraph 10.4.5.6.1 for tables).

- **10.4.4.6.2 Alternate orientation.** If it is not possible to display a figure in the preferred orientation, it shall be oriented so that the top of the figure is at the left side of the page (same as paragraph 10.4.5.6.2 for tables).

#### 10.4.4.7 Oversize figures

- **10.4.4.7.1 Facing pages.** If a figure is too large to fit on a single page, if possible, it should be divided into two parts that are presented on facing pages (same as paragraph 10.4.5.7.1 for tables).
- **10.4.4.7.2 Captions for divided figures.** If a figure is divided and displayed on two pages, the figure's caption, that is, its identifying number and title (see section 10.4.4.2), shall be repeated below each portion, with the word "Continued" in parentheses following the title (same as paragraph 10.4.5.7.2 for tables).
- **10.4.4.7.3 Foldout pages.** If a large figure cannot be divided and displayed on facing pages, it shall be displayed on a foldout page. See Section 10.3.2.8 for criteria and guidelines governing foldout pages (same as paragraph 10.4.5.7.3 for tables).

### 10.4.5 Tables

#### 10.4.5.1 General

- **10.4.5.1.1 When to use.** Tables should be used: 1) when data or text can be displayed more clearly than can be done otherwise, or 2) to show large amounts of data or text more compactly than could be done otherwise.

**Definition.** A table is an array of data or text in rows and columns. Usually at least one dimension, either the rows or the columns, is labeled; sometimes both are labeled.

**Examples.** Some examples of information that might be presented in tables are: 1) performance standards and operating tolerances, 2) functions of controls and indicators, 3) operating parameters, 4) turn-on and checkout procedures, 5) performance checks, and 6) procedures for preventive and corrective maintenance, alignment, and calibration.

#### 10.4.5.2 Identification

- **10.4.5.2.1 Number and title.** Each table shall have a unique identifying number and title. Numbers shall be assigned

consecutively, beginning with one, either for the document as a whole, or within divisions. If they are assigned within divisions, the division's identifying number shall form part of the table's identifying number, for example, "Table 2-1" would indicate the first table in division two. The table's title shall describe concisely what the table contains.

- **10.4.5.2.2 Caption.** Each table shall have a caption that consists of the word "Table" followed by its unique identifying number, two spaces, and a title. The caption shall be centered above the table.

### 10.4.5.3 Location

- **10.4.5.3.1 Table follows reference.** Tables shall follow, not precede, their first reference in the text (same as paragraph 10.4.4.3.1 for figures).
- **10.4.5.3.2 Preferred location.** A table should be placed on the same page as its reference, either within or following the paragraph that contains the reference. If the space following the reference is too small, the table should be located at the top of the following page. A table that fills a page should be placed on the page following the page containing its reference (same as paragraph 10.4.4.3.2 for figures).
- **10.4.5.3.3 Consistent location.** The relative location of a table to its first reference in the text should be consistent. If for some reason the preferred location specified in paragraph 10.4.5.3.2 is not satisfactory, all the tables should be grouped together near the end of the document. An example of this would be a document in which the space devoted to tables far exceeds the space devoted to text (same as paragraph 10.4.4.3.3 for figures).

### 10.4.5.4 Formatting

- **10.4.5.4.1 Organization.** Tables shall be organized to show the significance and relationships in their contents as clearly and simply as possible.
- **10.4.5.4.2 Type size.** The size of type used within a table shall be at least 8 points when the table is in its final form, that is, after any reduction or enlargement.
- **10.4.5.4.3 Row and column labels.** Rows, columns, or both shall be labeled as necessary to identify the entries in the table.
- **10.4.5.4.4 Units of measurement.** If the entries in a row or column consist of some sort of quantity, the unit of measurement, such as inches or degrees, shall be given in the row or column label; it shall not be repeated after each quantity.
- **10.4.5.4.5 Ease of reading.** It shall be easy for the reader to follow rows and columns visually.

**Discussion.** There are three common ways to help readers follow rows and columns: 1) the use of white space, for example, a blank line after every four or a maximum of five rows and generous spacing between columns, 2) the use of vertical and horizontal lines, and 3) the shading of alternate rows or columns. Contemporary practice is to use white space and shading rather than vertical and horizontal lines.

#### 10.4.5.5 Content

- **10.4.5.5.1 Useful and relevant.** The information presented in a table shall be limited to information that is likely to be used by a reader. Tables shall contain only information that is relevant to the associated text.
- **10.4.5.5.2 Nonredundant information.** Tables and text shall not be redundant; that is, tables shall not simply restate information that is presented in the text.

**Discussion.** This rule is not intended to prohibit text from quoting, summarizing, or commenting upon the information in a table. In general, the purpose of the associated text is to make the purpose of the table clear, and the purpose of the table is to present data relevant to the associated text.

#### 10.4.5.6 Orientation

- **10.4.5.6.1 Preferred orientation.** Tables should be oriented so that the reader can read them without rotating the page, that is, all text, including the table's identification and title and any row and column labels, should appear horizontally when the page is in its normal orientation (same as paragraph 10.4.4.6.1 for figures).
- **10.4.5.6.2 Alternate orientation.** If it is not possible to display a table in the preferred orientation, it shall be oriented so that the top of the table is at the left side of the page (same as paragraph 10.4.4.6.2 for figures).

#### 10.4.5.7 Oversize tables

- **10.4.5.7.1 Facing pages.** If a table is too large to fit on a single page, if possible, it should be divided into two parts that are presented on facing pages (same as paragraph 10.4.4.7.1 for figures).
- **10.4.5.7.2 Captions for divided tables.** If a table is divided and displayed on two pages, the table's caption, that is, its identifying number and title (see section 10.4.4.2) shall be repeated above each portion, followed by the word "Continued" in parentheses (same as paragraph 10.4.4.7.2 for figures).
- **10.4.5.7.3 Foldout pages.** If a large table cannot be divided and displayed on facing pages, it shall be displayed on a foldout page.



See section 10.3.2.8 for criteria and guidelines governing foldout pages (same as paragraph 10.4.4.7.3 for figures).

## 10.4.6 Lists

It is often convenient to present information in the form of a list.

**Definition.** As used in this section, a list is a series of similar or related items in which each item is marked and displayed on a separate line or lines. The markings can be graphic symbols, such as bullets (•) or squares (◻), or sequential identifiers, such as numbers or letters. An item can be a word, a phrase, a sentence, or a group of sentences.

- **10.4.6.1 When to use.** Lists should be used: 1) for clarity, for example, when several long phrases might be confusing if presented as continuous text, and 2) for sequential items, for example, the steps in a procedure.
- **10.4.6.2 Format.** The format for a list shall be:
  - a. an introductory sentence or sentence fragment, and
  - b. for each item, a new line containing 1) a mark, 2) the item, and 3) appropriate punctuation.

The next to last item in the list shall conclude with the word "and" or "or."

- **10.4.6.3 Marks.** If the items in a list have no precedence over each other and there is no need to refer to them individually, they should be marked with graphic symbols, such as bullets. If the items do have precedence, for example, if they are sequential steps in a procedure, or if they need to be referred to individually, they should be marked with numbers or letters.
- **10.4.6.4 Consistency of items.** All the items in a list should be either 1) single words or phrases, or 2) sentences or groups of sentences; that is, a list should not contain some items that are words or phrases and some that are complete sentences.
- **10.4.6.5 Punctuation -- items.** If an item consists of one or more complete sentences, it should be followed by a period. If an item is not a complete sentence, it should be followed by a comma, with two exceptions: 1) the next to last item should be followed by a comma and either the word "and" or "or," and 2) the last item should be followed by a period.

## 10.4.7 Formulas and equations

- **10.4.7.1 Identification.** Formulas and equations that occur in user documents shall be numbered consecutively, in Arabic numerals, beginning with one. The number shall appear in parentheses at the right margin on the last line of the formula or equation.

- **10.4.7.2 Location.** Short formulas and equations that are not part of a series should be placed in the text rather than displayed on a separate line. Formulas and equations that are longer or that are part of a series shall be displayed either indented or centered in a line immediately below the text that refers to them. A group of separate but related formulas or equations should be aligned on their equal signs, and the group as a whole should be indented or centered on the page.
- **10.4.7.3 Format.** If a formula or equation includes a numerator and denominator, they shall be separated by a line equal to the length of the longer term; both terms shall be centered with respect to the line.

## 10.4.8 Warnings, cautions, and notes

This section contains criteria governing the use of warnings, cautions, and notes.

**Definitions.** A warning is a written notice given to a reader when a situation might result in personal injury or loss of life; a caution is a written notice given when a situation might result in damage to or destruction of equipment or systems; a note is a written notice given to draw the reader's attention to something or to supply additional information.

- **10.4.8.1 When to use.** Warnings shall be provided whenever a step or procedure or the failure to perform a step or procedure correctly might result in personal injury to, or loss of life of, the maintainer or anyone else. Cautions shall be provided whenever a step or procedure or the failure to perform a step or procedure correctly might result in damage or destruction of equipment or systems. Notes shall be provided whenever it seems appropriate to call the reader's attention to something or to provide additional information.
- **10.4.8.2 Warnings.** Warnings shall consist of 1) the word "WARNING" in upper case letters, enclosed in a border, and centered on the page, and 2) the text of the warning, indented from both margins and centered on the page. The text of the warning shall include 1) a brief description of the hazard, 2) the likely result if the warning is ignored, and 3) specific steps to take to avoid the hazard. Warnings shall precede the information to which they apply.
- **10.4.8.3 Cautions.** Cautions shall consist of 1) the word "CAUTION" in upper case letters and centered on the page, and 2) the text of the caution, indented from both margins and centered on the page. The text of a caution shall include 1) a brief description of the hazard, 2) the likely result if the hazard is ignored, and 3) specific steps to take to avoid the hazard. Cautions shall precede the information to which they apply.
- **10.4.8.4 Notes.** Notes shall consist of 1) the word "NOTE" in upper case letters and centered on the page, and 2) the text of the note, indented from both margins and centered on the page. The text of a note shall include the information that is to be given to

the reader. Notes shall either immediately precede or immediately follow the information to which they apply, depending upon the content of the note and the text to which it applies.

- **10.4.8.5 Precedence of warnings, cautions, and notes.** If more than one type of notice applies at the same place in a document, for example, if a hazard exists to both people and equipment, the order in which the notices appear shall be warnings, cautions, and notes.
- **10.4.8.6 No procedural steps.** Warnings, cautions, and notes shall not contain procedural steps.

## 10.4.9 Appendixes

This section contains criteria and guidelines for appendixes.

**Definition.** An appendix is a body of supplementary information collected, labeled, and placed at the end of a document.

- **10.4.9.1 When to use.** Information that supplements, but is not integral to, the main body of a document should be placed in one or more appendixes. Examples of such information include illustrations, applications, calculations, and formulas. Appendixes should be used only if the information is essential.
- **10.4.9.2 Relation to main body.** The content of an appendix shall be within the scope of the document and shall not be inconsistent with the document itself. An appendix shall be referred to in the main body of the document.
- **10.4.9.3 Identification.** Each appendix in a document should have an identifying letter and a title. Identifying letters shall be assigned consecutively, beginning with "A." The title shall be brief but descriptive.

**Discussion.** FAA Order 1320.1D requires that appendixes of directives be identified by an Arabic numeral designator with pages numbered within each appendix (for example 1- page 1, 1- page 2 and so on). FAA-D-2494/b for instruction books uses roman numerals for appendix designators. The present guidance document recommends alphabetic designator for appendixes and page numbering within each appendix (for example, A-1, A-2, ... B-1, B-2, and so forth). This designation helps the user of reference type documents to distinguish between main chapters and appendixes and aids them in navigating through the document.

- **10.4.9.4 Location.** Appendixes shall be located at the end of a document, after the main body and any figures or tables, but before the glossary and index, if they exist.
- **10.4.9.5 Page numbering.** Each page of an appendix shall have a number that consists of the letter that identifies the appendix followed by a dash followed by the number of the page within the

appendix. For example, B-2 would indicate the second page of Appendix B. Page numbers shall be located in the same relative position on the page as page numbers in the main body of the document.

- **10.4.9.6 Pagnation.** Each appendix shall begin on a right-hand (odd-numbered) page. Appendixes shall not have title pages; rather the title shall appear at the top of the first page of the appendix.

## 10.4.10 Glossary

- **10.4.10.1 Terms.** Special terms and words used in technical or unusual ways shall be defined where they first appear in the text. If there are many such terms, they shall also be collected in a glossary located near the end of the document.
- **10.4.10.2 Format.** The glossary shall consist of 1) an alphabetic listing of all the special or unusual terms that appear in the document, and 2) their definitions. The definitions shall be the same as those that appear in the text where the terms are first defined.
- **10.4.10.3 Location.** A glossary shall be the next to last division of a document, coming after the body of the document and all figures, tables, and appendixes, but immediately preceding the index.

## 10.4.11 Index

An index can greatly enhance the usability of a document, increasing both the speed and the likelihood of a user's finding the desired information.

- **10.4.11.1 When to use.** Documents that are lengthy or complex shall have indexes.
- **10.4.11.2 Format and content.** An index shall consist of an alphabetic listing of the terms and topics that exist in the document and the pages on which they can be found. Each alphabetic group shall be preceded by the initial letter of the group. This letter shall appear in upper case type that is larger and bolder than the entries.
- **10.4.11.3 Level of detail.** An index should contain more levels of detail than does a table of contents.
- **10.4.11.4 Location.** An index shall be the last division of a document.

## 10.4.12 User feedback forms

- **10.4.12.1 When to use.** All user guides and manuals shall include forms inviting feedback from users.

- **10.4.12.2 Location.** User feedback forms shall be the very last pages in the document, that is, they shall be bound just before the back cover.
- **10.4.12.3 Content.** The form shall solicit from users of the document at least those categories of information illustrated in exhibit 10.4.12.3 (a). The fields for the document identifier and title shall be printed on the form, that is, the user shall not have to write them in. The form shall be self-addressed and shall have an "Official Business" postage permit, as illustrated in Exhibit 10.4.12.3 (b). Appendix 15 of FAA Order 1320.1D shows a sample feedback form for users of formal directives. This form encourages user to suggest subject matter for future additions.
- **10.4.12.4 Number of copies.** Three copies of the user feedback form shall be bound with the document.

### 10.4.13 Tabs

- **10.4.13.1 When to use.** Tabs should be provided if a document has many divisions. If a document has tabs, it should have a tab for each major division, for each frequently-used division, or both.

**Discussion.** Some sort of balance is needed between the number of tabs in a document and the number of pages between tabs. If there are a few long divisions, tabs might be used within divisions; on the other hand, if there are many short divisions, one tab might serve several divisions. A rule of thumb might be that three or four tabs is so few that they will not be helpful and that more than 20 or 30 tabs might be so many that they interfere rather than help.

### 10.4.14 Footnotes

Footnotes, like appendixes, are used to present information that is not properly a part of the text. The difference is that footnotes tend to be much shorter and more closely related to the specific text than are appendixes.

- **10.4.14.1 Minimize use of footnotes.** The use of footnotes shall be minimized.

**Discussion.** Footnotes may be distracting and often are ignored. If the information is important, it properly belongs in the text; if the information is not important, it is probably not necessary. Extensive supplemental information belongs in an appendix.

Exhibit 10.4.12.3 (a) User feedback form -- Front

---

*(Fold along this line)*

---

*(Fold along this line)*

Federal Aviation Administration

NO POSTAGE  
NECESSARY  
IF MAILED  
IN THE  
UNITED STATES

OFFICIAL BUSINESS  
PENALTY FOR PRIVATE USE \$300

**BUSINESS REPLY MAIL**  
Postage will be paid by the  
Federal Aviation Administration

*[Addressee]*

## 10.4.12.3 (b) User feedback form -- Back

**Instructions.** This form is provided as part of the FAA's continuing effort to improve documentation. Users of this document are invited to submit comments and suggestions, especially if they are aware of any difficulty associated with its use. To submit comments or suggestions: (1) remove this form from the document, (2) complete the applicable sections, (3) fold this form in thirds, using the lines on the reverse side as a guide, and (4) mail. No postage is necessary if the form is mailed in the United States.

---

Document Number:

Document Title:

---

Your name, address, and telephone number: (optional)

Date:

---

Please describe any difficulty associated with use of the document and add any comments or suggestions that might be helpful. (Please include the section or paragraph number, recommended changes, and your rationale for the recommendations, as applicable.)

- **10.4.14.2 Identification.** Footnotes to text shall be numbered consecutively throughout a document or throughout a division of a document. The reference to a footnote in the text shall consist of the footnote's number in superscript Arabic numerals immediately following the word or phrase to which it applies. The footnote itself shall be preceded by its identifying number, also in superscript. Footnotes to figures or tables shall be numbered consecutively or otherwise identified (see the following Exception) independently for each figure or table.

**Exception.** If footnotes occur in tables or figures, and the use of numbers to identify them might lead to confusion with numerical data in the table or figure, letters and symbols are acceptable alternatives for identifying footnotes.

- **10.4.14.3 Location.** Footnotes to text shall be located at the bottom of the page on which their reference in the text occurs. Footnotes to figures or tables shall be located immediately following the figure or table.
- **10.4.14.4 Additional rules.** The rules pertaining to footnotes given in the United States Government Printing Office *Style Manual* shall apply to footnotes in user documentation.

### 10.4.15 Copyright and patent issues

- **10.4.15.1 Copyrighted documents.** If a user document is or will be copyrighted, the copyright information shall be placed on the back of the title page.
- **10.4.15.2 Inclusion of copyrighted or patented material.** Copyrighted or patented material shall not be included in user documents without the prior consent of the owner of the copyright or patent. When such consent has been obtained, and if the owner requests it, an acknowledgment of the permission shall be placed in the document near the material.

### 10.4.16 Publication date

- **10.4.16.1 Location.** The date of publication shall appear at the center of the bottom of the front cover.

## 10.5 Specific user document contents

This section contains criteria and guidelines for two specific types of user document contents, proceduralized instructions and interactive electronic technical manuals.

### 10.5.1 Proceduralized instructions

Proceduralized instructions tell users how to complete tasks. They may be used for 1) mechanical procedures, such as assembling, servicing, and repairing units of equipment, 2) operating procedures, such as starting, operating, and shutting down systems or units of equipment, and 3) test procedures, such



as periodic maintenance tests and alignments. The instructions are presented as a series of steps.

**Definition.** A proceduralized instruction is a set of step-by-step instructions -- a procedure -- intended to ensure the successful completion of a task.

### 10.5.1.1 General

- **10.5.1.1.1 Procedures, tasks, subtasks, and steps.** A proceduralized instruction shall apply to a single task and shall present instructional information as a series of steps. A lengthy or complicated procedure may be divided into a series of related subtasks as long as each subtask accomplishes a distinct, recognizable objective.
- **10.5.1.1.2 Level of detail.** Proceduralized instructions shall include a level of detail that is appropriate to the intended users (see also paragraph 10.1.1.2).
- **10.5.1.1.3 Completeness.** Each proceduralized instruction shall contain all the steps and supporting information required to successfully complete the task.
- **10.5.1.1.4 Safety considerations.** The performance of all procedures shall be made as safe as possible by including all of the following safeguards that apply:
  - a. If possible, actions shall be performed with equipment shut down and isolated.
  - b. At the completion of a task or subtask, no portion of a unit of equipment shall be left in a dangerous state unless the procedure includes the posting of adequate warnings.
  - c. Steps that tell a user to remove voltage or pressure shall also tell the user to label or tag the switches, circuits, or valves involved.
  - d. If components capable of holding a charge are involved, the procedure shall tell the user how to discharge these components safely (see section 12.4.3).
  - e. Procedures shall include steps to restore equipment to a safe operating condition.
  - f. Procedures shall include warnings, cautions, and notes as appropriate.
- **10.5.1.1.5 General safety instructions.** A proceduralized instruction shall include a summary of any general safety information that applies throughout the task.

### 10.5.1.2 Organization and content

- **10.5.1.2.1 Hierarchical, logical, and consistent.** A proceduralized instruction shall be organized in a hierarchical, logical, consistent manner that is apparent to the user.
- **10.5.1.2.2 Identifying information.** Information identifying the procedure shall be displayed on the cover page of the procedure and in a header or footer on each page.
- **10.5.1.2.3 Title.** A proceduralized instruction shall have a title that is concrete, specific, and terse, and that uniquely identifies the task to be performed.
- **10.5.1.2.4 Headings.** If a proceduralized instruction contains distinct parts, each part shall have a heading. Headings shall conform to the requirements for titles (see paragraph 10.2.1.1.1).
- **10.5.1.2.5 Numbered steps.** Steps shall be numbered, using Arabic numerals, in a way that provides useful information to users without being overly complex.

**Discussion.** A complex step might be divided into a number of substeps, and the numbering might reflect this. For example, if step 6 has three substeps, the substeps might be numbered 6.1, 6.2, and 6.3.

- **10.5.1.2.6 Supporting information.** A proceduralized instruction shall include all of the following supporting information that is applicable:
  - a. An applicability statement that specifies the equipment or systems to which the procedure applies (for example, the applicability statement might list equipment model numbers and a range of serial numbers);
  - b. Any initial setup or input conditions required for the procedure;
  - c. A list of test equipment required;
  - d. A list of tools required;
  - e. A list of materials, consumable or expendable items, and mandatory replacement parts required;
  - f. A list of support equipment required;
  - g. If more than one, the minimum number of personnel required;
  - h. A system preparation checklist; and,
  - i. A list of any special environmental conditions required (for example, ventilation, lighting, temperature, noise

level, electromagnetic interference, cleanliness, and humidity).

- **10.5.1.2.7 Appendixes and attachments.** Information that is important and useful but not easily incorporated into a procedure should be presented in an appendix or attachment to the procedure. However, the use of appendixes and attachments should be minimized.

**Examples.** Types of information presented in appendixes or attachments might include contingency actions, actions performed by someone other than the user of the procedure, and periodic steps.

### 10.5.1.3 Format

- **10.5.1.3.1 Step numbers and text.** The text of a step shall begin on the same line as its number, separated from the number by two spaces. If the text fills more than one line, the additional line or lines shall begin under the first letter of the first line, not under the number.
- **10.5.1.3.2 Check off provision.** If appropriate, the proceduralized instruction should provide a line or box adjacent to a step so that a user can check off the step when it has been completed.

**Discussion.** The provision of a check off can serve a variety of functions; it can serve as a placeholder in cases in which a user refers to another part of the procedure or another procedure; it can serve as a record of the completion of the step; and it can be used to identify the applicable condition in a conditional step.

- **10.5.1.3.3 Lists.** If a step contains a sequence of three or more items (for example, actions, conditions, or units of equipment), the items should be presented in a list format (see section 10.4.6).
- **10.5.1.3.4 Illustrations.** If a step refers to an illustration, it shall be possible for the user to see both the step and the illustration simultaneously. This may be accomplished by placing the illustration 1) within the step in which it is used, 2) on the same page as the step, 3) on a facing page, or 4) on a foldout page (see section 10.3.2.8).

### 10.5.1.4 Typographic matters

- **10.5.1.4.1 Legibility.** A proceduralized instruction shall be legible in the worst conditions under which it is expected to be used.

**Discussion.** Legibility depends primarily upon the size of the type (see section 10.3.3.1), the type style (see section

10.3.3.5), the case of the letters (see section 10.3.3.6), and the print contrast (see section 10.3.3.8).

- **10.5.1.4.2 Justification.** The justification of text in proceduralized instructions shall be in accordance with section 10.3.3.4.
- **10.5.1.4.3 Typographic emphasis.** The use of typographic emphasis in proceduralized instructions shall be in accordance with section 10.3.3.7.

### 10.5.1.5 Wording of steps

- **10.5.1.5.1 Completeness.** Each step shall contain all the instructions and supporting information required to successfully complete the step.
- **10.5.1.5.2 Grammar.** The steps in a proceduralized instruction shall be comprised of grammatically correct sentences.
- **10.5.1.5.3 Capitalization, punctuation, and hyphenation.** The capitalization, punctuation, and hyphenation of text in a proceduralized instruction shall be in accordance with section 10.2.3.10.
- **10.5.1.5.4 Action statements and indication statements.** If appropriate, a step in a proceduralized instruction shall be comprised of an action statement followed by an indication statement. The indication statement shall include any applicable values or tolerances.

**Definitions.** An action statement is an action verb followed by the object or item acted upon. An indication statement states the name of an indicator that the user reads or observes and the indication expected to result from the action. The stated indication is what is expected if the equipment or system is operating normally.

- **10.5.1.5.5 List of standard verbs.** To the extent possible, the verbs used in proceduralized instructions shall be selected from the list of standard verbs given in Appendix D (see paragraph 10.2.4.4.1).
- **10.5.1.5.6 Sentences.** Sentences used in steps in proceduralized instructions shall be in accordance with section 10.2.3.
- **10.5.1.5.7 Words and symbols.** The words and symbols used in steps in proceduralized instructions shall be in accordance with section 10.2.4.
- **10.5.1.5.8 Standard steps.** If the same (or highly similar) action or indication occurs more than once in a procedure, a standard wording shall be adopted and used consistently throughout the procedure. Such standard wording shall, as appropriate, accommodate different objects and indicators.

- **10.5.1.5.9 Conditional steps.** Steps that are to be performed only if a specified condition exists shall begin with the word "if" or "when" and a statement of the condition, followed by the word "then" and the action statement. If and then shall be emphasized typographically (see section 10.3.3.7). If the condition is negative, the word not shall be used and emphasized.

**Examples.** Examples of conditional steps are: "If the status light is green, then press the override button," "When engine speed reaches 2000 RPM, then engage the clutch," and "If the status light is not green, then press the power switch."

- **10.5.1.5.10 No calculations.** If possible, no step shall require a user to make a calculation. If a calculation is necessary, the step shall include a calculation aid, for example, a series of step-by-step instructions for carrying out the calculation.
- **10.5.1.5.11 Numerical precision.** If a step contains numerical information that relates to an indicator, the precision of the information in the step should not exceed the precision of the indicator. For example, if an instrument dial can be read only to the nearest five units, the step should not require a reading to the nearest single unit.
- **10.5.1.5.12 Numerical ranges.** If a step specifies a range of numerical values, the range shall be stated as the upper and lower values, not as the middle value plus and minus an increment. For example, a temperature range might be stated as 75-85°F, not as 80°F ±5°.

#### 10.5.1.6 Warnings, cautions, and notes in proceduralized instructions

- **10.5.1.6.1 Use.** Warnings, cautions, and notes shall be included in proceduralized instructions, as appropriate, and shall be in accordance with section 10.4.8. Note especially paragraph 10.4.8.6, which prohibits the use of procedural steps in warnings, cautions, and notes themselves.

#### 10.5.1.7 Branching and cross-references

Not every procedure is a simple, sequential series of steps. Some require branching depending upon conditions (for example, "If the condition is *A*, then go to step *X*; if the condition is *B*, then go to step *Y*"), and some require a temporary reference to another step or procedure followed by a return to the current procedure (for example, "If the condition observed in step *N* is *C*, then perform procedure *Z* before performing step *N+1*").

- **10.5.1.7.1 Minimize use.** The use of branching and cross-referencing in proceduralized instructions shall be minimized.

- **10.5.1.7.2 Explicit instructions.** Branching and cross-referencing shall be explicit, not implicit.
- **10.5.1.7.3 Content.** Branching and cross-referencing instructions shall provide all necessary information and shall be worded consistently.

**Examples.** Branching instructions might be worded: "If ..., then go to step ..." A cross-referencing instruction might be worded: "Refer to steps ... then return to step ..."

### 10.5.1.8 Miscellaneous

- **10.5.1.8.1 Simultaneous actions or indications.** If a procedure includes actions that must occur simultaneously or indications that occur simultaneously, the actions or indications shall be included in the same step.
- **10.5.1.8.2 Format for diagnostic steps.** The format of a diagnostic step should be appropriate to the immediate task.
- **10.5.1.8.3 Nonsequential steps.** Steps that need not be performed in a fixed sequence should be presented in a way that makes clear when they should be performed and that ensures they are not omitted.

**Discussion.** In some cases, a number of steps must be performed, but the order in which they are performed does not matter. In others, a step must be performed when a condition is met, for example, shutting a valve when a tank becomes full. In still others, a step must be performed at specified intervals or at a specified time after an action has been taken.

- **10.5.1.8.4 Verification steps.** Steps that require a user to verify that a stated condition is met should be presented in an appropriate format, for example, with a check box. If a procedure contains more than one verification step, the verification steps should have a consistent format.
- **10.5.1.8.5 Equally-acceptable steps.** Steps that tell a user to perform one of a number of equally-acceptable actions should be presented in a format that makes clear exactly what the user is to do, for example, to select and perform one and only one action.
- **10.5.1.8.6 Actions performed from memory.** If a procedure includes one or more steps that a user is expected to perform from memory, the written procedure shall include those steps.

**Example.** The first step(s) in an emergency procedure may have to be done from memory. Whenever the total procedure is written out, the memorization steps are assumed to be necessary and are included.

## 10.5.2 Interactive electronic technical manuals

- **10.5.1.8.7 Procedures involving more than one person.** A procedure that involves more than one person shall be presented in a way that assigns actions and observations to individuals and integrates the actions and observations of all the individuals into a single series of steps.

Interactive electronic technical manuals are technical manuals designed for interactive use on an electronic display system. This medium has many advantages, such as 1) tailoring the presentation to the user, for example, presenting highly detailed information to novice users and condensed information to experienced users, 2) tailoring the presentation to the situation, for example, following one branch rather than another based on a user input, 3) permitting the manipulation (such as movement or enlargement) of diagrams, and 4) permitting easy access to information, such as parts information.

### 10.5.2.1 General

- **10.5.2.1.1 Contents.** The contents of an interactive electronic technical manual shall be in accordance with section 10.4.
- **10.5.2.1.2 Access to contents.** A user shall be able to access directly any portion of the manual that appears in a list of its contents.
- **10.5.2.1.3 Help information.** The system shall provide at the user's request additional information relating to the technical content of all sections of the electronic technical manual. This help shall include both context-sensitive help applicable to the user's current activity and situation, and descriptive information on a specific term, technical point, or process (see also section 8.6.1). Help information shall include:
  - a. administrative information about the manual itself, for example, the title and identification, the version number, the date of the latest change, and the preparing organization;
  - b. an easily noticeable applicability statement that specifies precisely the equipment or system to which the manual applies, including model numbers and serial numbers, if applicable;
  - c. an introduction that states the purpose, scope, contents, organization, and range of tasks covered by the manual;
  - d. information on how to use the help information;
  - e. information about the computer system being used to view the manual;
  - f. instructions on the use of any utility functions provided, for example, the automatic preparation and submission of reports;

- g. information about function keys and other keyboard features;
- h. general information about the task being performed or the portion of the manual being used;
- i. specific, context-sensitive help;
- j. an index of help information; and,
- k. definitions of abbreviations and unusual terms.

**Discussion.** The above rule does not imply that an electronic technical manual or a help subsystem can merely be a paper manual transposed to a help role by its presentation or availability through a computer system monitor. To the contrary, such a practice may produce a nearly useless help system or electronic technical manual. Help systems and electronic technical manuals need to be designed along with the system, especially along with software systems.

Such systems and electronic manuals need to be based upon human understanding of technical information related to human tasks, processes, interfaces, and other subsystem that they use and maintain to enable their individual and collective purposeful endeavors. Using computer technology to turn pages is a questionable practice. Hypertext help is much more appropriate than a paper manual transposed to be a help system.

- **10.5.2.1.4 Safety summary.** If an interactive electronic technical manual contains one or more warnings or cautions, it shall also include a safety summary.

### 10.5.2.2 Text

- **10.5.2.2.1 Applicable information.** The system shall present to users only information that applies to the specific equipment or system configuration and situation.
- **10.5.2.2.2 Level of detail.** An interactive electronic technical manual shall contain all the information necessary for a user 1) to perform the task involved without error or loss of time due to insufficient information, or 2) to comprehend a description. It shall not contain unnecessary detail.
- **10.5.2.2.3 Procedures in steps.** If a step includes a procedure that is specific to the equipment or system, the procedure shall be included in the step. If a step includes a general purpose procedure that is likely to be performed without reference to technical information by an experienced technician, the user shall be given the option of bypassing presentation of the procedure.
- **10.5.2.2.4 Accommodating novice and expert skill levels.** If specified by the acquisition program office, an interactive



electronic technical manual shall offer two levels of detail, one for a novice skill level, and one for an expert skill level. The novice skill level shall contain all information necessary for an inexperienced user to perform the task involved or to comprehend a description. The expert level shall function as a checklist, presenting only the steps required to complete a task or providing a description in broader terms, requiring a higher level of theoretical knowledge. Both levels shall contain all pertinent warnings and cautions. The expert user shall be able to access information at the novice level, but the novice user shall not be able to access information at the expert level unless otherwise specified by the acquisition program office.

- **10.5.2.2.5 Writing the text.** The text of an interactive electronic technical manual shall be in accordance with section 10.2 and, if it includes procedures, with section 10.5.1.

### 10.5.2.3 Graphics

The types of graphic displays that might appear in an interactive electronic technical manual include, but are not limited to, locator diagrams, functional block diagrams, general support graphics, schematics, wiring diagrams, flow diagrams, graphs, and charts.

- **10.5.2.3.1 General requirements.** Graphic displays in interactive electronic technical manuals shall be in accordance with sections 8.5.5 and 10.4.4.
- **10.5.2.3.2 Minimum quality.** Graphic displays shall meet the general requirements of paragraph 10.5.2.3.1 when displayed on the least capable device (for example, the smallest screen) on which the manual is intended to be used.
- **10.5.2.3.3 Interaction with graphics.** A displayable graphic may or may not be designed to be used interactively. If a graphic is not interactive, it shall be displayed in full detail; if it is interactive, a user shall be able to 1) manipulate the graphic for a better view, for example, by moving or re-sizing it, 2) choose selectable areas within the graphic, or 3) both.

**Discussion.** An interactive graphic would be appropriate if the graphic is so large or detailed that it cannot be displayed in full detail in the space available, and thus requires the use of scrolling or zooming.

- **10.5.2.3.4 Detail and context.** Graphics shall present only the equipment items to which action statements refer and enough of their surroundings to permit a user to locate and isolate an item without error. Unnecessary details that reduce the comprehensibility and clarity of the graphic shall be omitted.
- **10.5.2.3.5 Citations of equipment nomenclature.** If a graphic contains labels or citations that refer to controls, control positions, test points, and indicating devices that are labeled on the equipment, the graphic labels shall appear exactly as they appear on the equipment (for example, using all capital letters if the equipment label does).

- **10.5.2.3.6 Angle of view.** Graphics shall be drawn from the same general angle of view that the equipment presents to a user. Cutaways and hidden lines shall be used as necessary in conjunction with details that are accessible but not visible to a user. In situations in which a user is able to view the equipment from more than one angle, the view that provides the most pertinent and necessary information in the simplest fashion shall be used. An item or part removed from the equipment may be rotated to show important features, but, if so, the axis, direction, and degrees of rotation shall be indicated in the graphic. Perspective and isometric projections shall be used rather than orthographic projection, unless the view is head-on.
- **10.5.2.3.7 Use of a human figure.** If it is necessary to illustrate an operation or procedure, a graphic shall include a human figure or the relevant body parts. Jewelry shall not appear in graphics. The human figure or part shall not obscure details of the equipment necessary for a complete understanding of its operation. The human figure shall be clothed as specified by the acquisition program office. A cross section of races and sexes shall be used.
- **10.5.2.3.8 Callouts.** Callouts shall be provided to identify specific features of interest on graphics. Callouts shall be in accordance with paragraph 10.4.4.5.2.
- **10.5.2.3.9 Schematic and wiring diagrams.** Unless specified otherwise by the acquisition program office, a wire list, schematic, or wiring diagram that is displayed in association with text shall be simplified to contain only the information referred to in the text. However, a user shall have access to the entire wire list, schematic, or wiring diagram.
- **10.5.2.3.10 Functional flow diagrams.** Functional flow diagrams shall be drawn as flowcharts indicating the direction of system interaction. The information shall flow from left to right and top to bottom on diagrams. The diagrams shall indicate the detail referenced by the accompanying text.
- **10.5.2.3.11 Locator graphics.** Locator graphics shall enable a user to find specific hardware items (for example, parts, switches, controls, or indicators) referred to in the technical information. A locator graphic shall consist of a labelled graphic together with required callouts. The locator graphic shall show what a particular item looks like and illustrate its relationship to its immediate surroundings on the equipment illustrated. Locator graphics, if used, shall either be included as an option for selection by a user, or as an automated part of the presentation of procedural or descriptive information.
- **10.5.2.3.12 Placement of locator graphics.** Locator graphics shall be integrated with their associated technical information as follows:
  - a. Individual equipment items (for example, parts, switches, controls, and indicators) shall be shown in the physical

context of major equipment components. The nomenclature of major equipment components shall be shown on the graphic.

- b. Index numbers on callouts shall be assigned on the equipment item locator graphic either 1) in clockwise sequence, or 2) in the sequence that items are discussed in procedural steps.
  - c. If a procedural step includes a reference to an illustrated equipment item, the reference shall cite either a callout or an index number with a leader line pointing to the referenced item.
- **10.5.2.3.13 Exploded item views.** Exploded views of items shall be used as locator graphics only if further disassembly is required.
  - **10.5.2.3.14 Minimum size of a locator graphic.** The minimum size of a locator graphic shall enable a user to quickly identify the surroundings and the item to be located with respect to the surroundings. A callout shall be used to emphasize the item to be located.
  - **10.5.2.3.15 Animated information.** The motion of animated information shall be easily discernable by a user and clearly differentiated from its background and from static information on display.
  - **10.5.2.3.16 Video controls.** If an interactive electronic technical manual includes an animated or motion video sequence, the sequence shall repeat automatically after completion. A user shall be able to pause, repeat, and exit the sequence.

#### 10.5.2.4 Audio

- **10.5.2.4.1 Redundant visual information.** Audio information shall always be accompanied by redundant visual information so that the information presentation is effective even if its audio output device is not available. Audio information shall be in accordance with section 7.3.
- **10.5.2.4.2 When to use nonverbal auditory signals.** Nonverbal auditory signals shall be limited to applications in which immediate discrimination is not critical to personnel safety or system performance.
- **10.5.2.4.3 When to use computer-generated and electronically-stored speech.** Computer-generated and electronically-stored speech shall be limited to the presentation of procedural information.
- **10.5.2.4.4 Audio controls.** If an interactive electronic technical manual includes either verbal or nonverbal audio signals, it shall provide users the ability to 1) request a repetition of any signal,

2) adjust the volume of the signals, and 3) turn the audio signals on and off.

- **10.5.2.4.5 Pronunciation of abbreviations.** Computer-generated and electronically-stored speech shall pronounce the entire word or phrase an abbreviation represents unless the abbreviation is pronounced as individual letters in common usage. Acronyms in common use shall be pronounced as the acronym.

**Examples.** The abbreviation "mm" would be pronounced "millimeter." The abbreviation "SSE" would be pronounced "south south east." The abbreviation SFO (for Sector Field Office) would be pronounced "S" "F" "O." The acronym "TELCO" (for telephone company) would be pronounced "telco."

- **10.5.2.4.6 Pronunciation of alphanumeric strings.** Strings of digits or alphanumeric characters that are not ordinarily pronounced as a unit shall be pronounced as a series of single letters or digits.

### 10.5.2.5 Warnings, cautions, and notes

- **10.5.2.5.1 When to include warnings and cautions.** If it is impossible to avoid the use of or exposure to hazardous materials, conditions, or equipment, the technical information shall be supplemented with a warning or caution designed 1) to attract the user's attention to practices, procedures, and conditions that could lead to injury or equipment damage, 2) to warn the user about the performance of certain hazardous actions, and 3) to state how the procedure can be performed safely. Warnings, cautions, and notes shall be in accordance with section 10.4.8.

- **10.5.2.5.2 Readable and comprehensible.** Warnings, cautions, and notes shall be easy to read and understand in the work environment in which they are likely to appear.

**Note.** If more than one type of danger may be present, or if danger can come from more than one source, or if one type of danger may require more than one remedial action, the dangers and actions may be referred to once in a single, combined warning or caution.

- **10.5.2.5.3 Association of warnings and cautions with text.** A warning or caution shall be directly associated with and precede in logical sequence the text or procedural step to which it applies.
- **10.5.2.5.4 Location of warnings, cautions, and notes.** Warnings, cautions, and notes that are presented in dialog boxes shall be displayed in the approximate center of the display area, and normal operation of the system shall not resume until a user acknowledges the message. Upon acknowledgement, the box shall be removed and normal operation resumed.

- **10.5.2.5.5 Color in warning, caution, and note displays.** If color is used in interactive electronic technical manuals, the color red shall be associated with warnings, yellow with cautions, and cyan with notes.
- **10.5.2.5.6 Borders for warnings, cautions, and notes.** Warnings, cautions, and notes presented in dialog boxes shall be enclosed in borders consisting of diagonal bars, alternating between the background color or white and the designated message color. The text shall be displayed within the border.
- **10.5.2.5.7 When to use notes.** Notes shall be used to supply needed information that is not a step in a procedure. Information in notes shall be limited to necessary specifics. Required tolerances and clearances shall not be given in notes; they shall be included in procedural steps.
- **10.5.2.5.8 Association of notes with text.** A note shall either directly precede or directly follow the applicable text depending upon the point to be emphasized. A note shall precede a procedural step to which it applies.

### 10.5.2.6 Interaction style

- **10.5.2.6.1 Dialog boxes.** If windowing is used, a dialog box shall be the principal means by which a user interacts with an interactive electronic technical manual. The box shall be displayed in a separate window and shall contain a heading and one or more control push buttons (see section 8.1.15.2). All boxes shall have an **OK** push button and, if appropriate, a **Cancel** push button. Dialog boxes shall appear in a consistent and prominent part of the display, and shall be easily distinguishable from other types of displayed information.
- **10.5.2.6.2 Dialogs.** Dialogs shall be formulated as prompting questions that are presented to the user and that require a response from the user. The system response shall be appropriate to the user's response.
- **10.5.2.6.3 Prompts.** A standard symbol or layout shall be used with prompts to indicate to a user that an explicit response is expected. The symbol or layout shall be used exclusively for this purpose. The user's response shall be displayed adjacent to the prompt.
- **10.5.2.6.4 Changing responses to prompts.** A user responding to a series of prompts in a single portion of a procedure shall be able to change any previously entered response as long as that change does not alter the logic of the procedure.
- **10.5.2.6.5 Alert dialogs.** Alert dialogs, that is, warnings, cautions, notes, any message or output that requires acknowledgement by the user, and messages about the processing status of user inputs and requests, shall be in accordance with section 8.3.10.2.

- **10.5.2.6.6 Navigation operations.** Users shall have at least the following navigation functions:
  - a. **Next.** This operation shall display the next section of information appropriate to the context.
  - b. **Back.** This operation, the opposite of **Next**, shall display the previous section of information appropriate to the context.
  - c. **Return.** If the manual provides branching, this operation shall return the user from a branch to the branching point, resetting any temporary system state information relative to the branch.
  - d. **Browse back, Browse next, and Browse exit.** If the **Next** and **Back** operations set interactive system variables that affect subsequent navigation through the manual, browse functions shall be available that act as **Next** and **Back** but without affecting the system variables. Once the **Browse next** or **Browse back** operation has been selected, the normal **Next** and **Back** operations shall not be available until the user invokes the **Browse exit** operation. The system shall provide a distinct visual indication when the system is in the browse mode.

**Definitions.** **Browse back** is the action of moving to the previous window without permanently resetting system variables; however, system variables in the temporary state table will be reset. **Browse next** is the action of moving to the succeeding window without permanently setting system variables; however, system variables will be set to a temporary state table. **Browse exit** is the action of leaving browse mode.
- **10.5.2.6.7 Data access operations and features.** An interactive electronic technical manual shall provide users at least the following access operations or features:
  - a. **Marking.** Users shall be able to mark a displayed information element for later recall. "Marking" shall include the ability to create, name, delete, modify, and go to a mark.
  - b. **Outline and index.** Users shall have access to information through a hierarchical outline of the manual, an index, or both.
  - c. **Functional diagrams.** If a manual includes a functional diagram or graphic, users shall be able to gain access to information by selecting the appropriate portion of the diagram.
  - d. **Search.** Users shall be able to gain direct access to information by entering selection information in a Search operation.

- e. Level of detail. If a manual provides different levels of detail and choice of level is intended to be selectable by the users, users shall be able to select the desired level, for example "3.5.2.2.5."
- f. Cross-references. If a displayed information element has a cross-reference or other related information associated with it, the element shall include a clear indication of that fact, and a user shall be able to display the related information and then return to the original display using the **Return** operation (see paragraph 10.5.2.6.6.c).

### 10.5.2.7 User interface

- **10.5.2.7.1 User-manual interaction.** The interaction between a user and an interactive electronic technical manual shall be in accordance with section 8.1.
- **10.5.2.7.2 Display formatting.** The display formatting of an interactive electronic technical manual shall be in accordance with section 8.5.
- **10.5.2.7.3 Consistency.** The user-manual interaction and the display formatting of an interactive electronic technical manual shall be consistent across all devices upon which the manual can be presented.
- **10.5.2.7.4 Window presentation.** If an interactive electronic technical manual is designed for presentation on a system capable of windowing, the manual shall be in accordance with section 8.3.

### 10.5.2.8 Special requirements for proceduralized instructions

- **10.5.2.8.1 Form and content.** Procedural information in an interactive electronic technical manual shall be directive in form. It shall instruct a user how to operate, test, maintain, or repair a system. It shall contain the directive information (for example, the steps) and any additional supporting material needed or helpful in the successful completion of a procedure.
- **10.5.2.8.2 General.** Proceduralized instructions in an interactive electronic technical manual shall be in accordance with section 10.5.1.

### 10.5.2.9 Special requirements for troubleshooting information

- **10.5.2.9.1 Troubleshooting logic.** The fundamental logic for interactive troubleshooting shall be specifically designed and shall include, but not be limited to, predefined fault isolation

sequences and dynamically generated fault isolation recommendations based on system or user inputs.

- **10.5.2.9.2 Contents.** Troubleshooting information shall include, but not be limited to 1) symptoms, 2) procedures, such as tests, repairs, and scheduled maintenance, 3) graphics, locator diagrams, and schematics, 4) parts and test equipment information, 5) equipment failure history, and 6) theory of operation. In addition, after a fault has been isolated, the manual shall permit direct access to relevant corrective maintenance procedures.
- **10.5.2.9.3 User inputs.** Users shall have the following capabilities:
  - a. the ability to enter symptom information 1) by typing or 2) by initiating automatic retrieval from the system or equipment under observation,
  - b. the ability to enter and change test results, if appropriate,
  - c. the ability to confirm conditions or states if necessary to continue a maintenance action,
  - d. the ability to review and browse through previous actions and test results, and
  - e. the ability to access information needed to troubleshoot the system or equipment in an efficient and clearly defined manner.
- **10.5.2.9.4 Predefined fault isolation sequences.** Each step in a predefined fault isolation sequence shall be based on the reporting of an observed symptom or the result of a previous test and shall specify the next procedure, test, or corrective maintenance action.

**Definition.** A **predefined fault isolation sequence** is a sequence of fixed procedures and tests that leads to a suspected fault. It is similar to a fault tree in a fault isolation manual.
- **10.5.2.9.5 Presentation of a predefined fault isolation sequence.** Predefined fault isolation sequences shall be presented as procedural steps that prompt users to perform tests, make observations, or perform corrective repair actions.
- **10.5.2.9.6 Dynamically-generated fault isolation recommendations.** Dynamically-generated fault isolation recommendations shall be derived from user inputs along with stored information and automated inputs. The system shall provide users recommendations of tests to perform or actions to perform to aid in the fault isolation process. Results of the tests or actions shall be used to update the system status and shall result in further recommendations, as appropriate.



**Definition.** A **dynamically-generated fault isolation recommendation** is a recommendation made by a computer system based on stored information and information received from user inputs, automated system inputs, or both. The information used by the system may include historical information, heuristics, probability factors, and cost factors. The recommendation may be derived using model-based reasoning, dependency models, fault-based reasoning, rule-based logic, information theory, or advanced artificial intelligence schema.

- **10.5.2.9.7 Presentation of dynamically-generated fault isolation recommendations.** The starting point for dynamic troubleshooting shall be depicted in some representational form, for example, a functional or connectivity block diagram. These depictions shall convey information about the current components under investigation and any suspected faults. By interacting with the depictions, users shall be able to obtain additional information, such as lower levels of system detail, theory of operation, and parts information. Information presentation shall not be limited to a single set of troubleshooting recommendations, but shall permit users to view additional information such as a "best test" or "best repair list," previous actions performed during the troubleshooting process, test results, and block diagrams.

#### **10.5.2.10 Presentation of parts information**

- **10.5.2.10.1 Information available.** An interactive electronic technical manual shall include a data base of supporting parts information that 1) permits unambiguous identification of all parts that are replaceable or repairable at the current level of maintenance, 2) shows the precise physical relationship of each part to other parts of the system, and 3) provides the user the information needed to order parts through the use of an automatically-generated parts ordering form.
- **10.5.2.10.2 Accessibility of parts information.** Users shall be able to access information about a part at any time that part is identifiable in a display. Relevant displays include:
  - a. locator diagrams.
  - b. logic flow diagrams or circuit diagrams.
  - c. portions of text that cite the part using any valid designation of the part.
  - d. a dialog prompt for parts information.
- **10.5.2.10.3 Direct access.** Users shall be able to obtain parts information directly by specifying a part using any applicable part identification or numbering system.

### 10.5.2.11 Descriptive information

- **10.5.2.11.1 Information available.** An interactive electronic technical manual shall include descriptive information to assist a user in the comprehension of procedural information. Descriptive information shall include, but not be limited to, theory of operation, diagrams, and general knowledge.
- **10.5.2.11.2 Presentation of descriptive information.** Descriptive information need not conform to any specified format, but shall be easily understandable and usable (see section 10.2). Section and paragraph headings shall be employed as needed to assist users in identifying or understanding the organization of descriptive information (see section 10.2.1).

## 10.6 Accommodating people with disabilities

The "Americans with Disabilities Act of 1990" (Public Law 101-336) prohibits employment discrimination against qualified individuals with disabilities. If a person's disability creates a barrier to employment, the Act requires that the employer consider whether reasonable accommodations could remove the barrier. The intent of the Act is to permit people with disabilities to compete with people without disabilities on the basis of the same performance standards and requirements once such accommodations have been made. This section presents accommodations that might be made in user documentation. For more information about accommodating people with disabilities, see sections 7.6, 9.7, and 8.9.

- **10.6.1 Electronic documentation.** Manuals and other important documentation intended to be accessible to people with disabilities should be available in electronic as well as printed form. This would permit presentation of the material on an assisting device such as an enlarged display, a speech synthesizer, or a braille reader. Both text and graphic information should be included (same as paragraph 8.9.8.1).
- **10.6.2 Convertible format.** When intended or necessary for use by people with specific disabilities, documentation should be available in formats (for example ASCII format for normal text) so that it can be converted easily into speech or braille.
- **10.6.3 Readability and handling.** Printed documentation should be designed to maximize the number of people who can read and handle it.

**Discussion.** People with visual disabilities may have difficulty reading printed documentation, and people with physical disabilities may have difficulty handling documentation. Possible solutions include:

- a. providing documentation in alternate formats, electronic, large-print, audio tape, and braille.
- b. using type that is as large as possible or practical.

- c. not using color as the only coding device.
  - d. providing a textual description of all graphic information.
  - e. providing basic instructions directly on the device as well as in the documentation.
  - f. ensuring that the documentation is compatible with electronic scanning and optical character reading devices.
- **10.6.4 Understandability.** Documentation should be designed to maximize the number of people who can understand it.

**Discussion.** People who have cognitive or language disabilities may have particular difficulty understanding documentation. Possible solutions include:

- a. providing descriptions that do not require illustrations, at least for the basic operations.
- b. highlighting key information and place it near the beginning of the text.
- c. providing step-by-step instructions using numbers, bullets, or check boxes.
- d. avoiding directional terms, such as left, right, up, and down, as much as possible.
- e. providing a section of the document that gives a user just enough information to get the equipment or system running with basic features. Audio or video tapes may be effective alternatives to printed documentation.

## Section 11 contents

<b>11 System security</b> .....	<b>11-1</b>
<b>11.1 General design practice</b> .....	<b>11-1</b>
▪ 11.1.1 Integrated security safeguards .....	11-1
▪ 11.1.2 Risk analysis and security planning .....	11-2
▪ 11.1.3 Human-security safeguard interfaces .....	11-2
▪ 11.1.4 Accreditation and certification .....	11-2
▪ 11.1.5 Security test and evaluation .....	11-2
▪ 11.1.6 Nonautomated security measures .....	11-3
▪ 11.1.7 Alarm for security safeguard failure .....	11-3
▪ 11.1.8 Security incidents .....	11-3
□ 11.1.9 Tracking security incidents .....	11-3
<b>11.2 Physical security and access control</b> .....	<b>11-3</b>
▪ 11.2.1 Consider the users .....	11-3
▪ 11.2.2 Remote monitoring .....	11-4
□ 11.2.3 Automatic access control .....	11-4
▪ 11.2.4 Alarms .....	11-4
▪ 11.2.5 Access control log .....	11-4
<b>11.3 Identification and authentication</b> .....	<b>11-4</b>
<b>11.3.1 General</b> .....	<b>11-5</b>
□ 11.3.1.1 Timeliness of the security administrator's tasks .....	11-5
▪ 11.3.1.2 Task simplicity .....	11-5
▪ 11.3.1.3 Log on process .....	11-5
▪ 11.3.1.4 Log on prompts .....	11-5
□ 11.3.1.5 Log on delay .....	11-5
□ 11.3.1.6 Unsuccessful log on attempts .....	11-5
□ 11.3.1.7 Terminal and user-id "lock-out" .....	11-5
▪ 11.3.1.8 Log on entry .....	11-5
▪ 11.3.1.9 Access protection .....	11-5

□ 11.3.1.10 Interface links to minimize authentications in networks .....	11-7
□ 11.3.1.11 Additional authentication .....	11-7
■ 11.3.1.12 Transparent control over user actions .....	11-7
■ 11.3.1.13 Continuous recognition of user identity .....	11-7
□ 11.3.1.14 Duress entries .....	11-7
<b>11.3.2 Passwords</b> .....	<b>11-7</b>
□ 11.3.2.1 Changing passwords .....	11-8
■ 11.3.2.2 Process for changing passwords .....	11-8
□ 11.3.2.3 Password protection .....	11-8
■ 11.3.2.4 Recording of date and time of log on .....	11-8
■ 11.3.2.5 User feedback .....	11-8
<b>11.3.3 Other identification and authentication technologies</b> .....	<b>11-8</b>
<b>11.4 Auditing</b> .....	<b>11-9</b>
■ 11.4.1 Monitoring user access .....	11-9
■ 11.4.2 Data reduction tools .....	11-9
■ 11.4.3 Auditing events or programs .....	11-9
■ 11.4.4 Auditing users or security levels .....	11-9
<b>11.5 Information and data protection</b> .....	<b>11-9</b>
<b>11.5.1 General</b> .....	<b>11-9</b>
■ 11.5.1.1 Automated security measures .....	11-9
■ 11.5.1.2 Integrity of data .....	11-9
■ 11.5.1.3 Warning of threats to security .....	11-9
■ 11.5.1.4 "Read-only" status .....	11-10
■ 11.5.1.5 Degraded system warning .....	11-10
<b>11.5.2 Classified data protection</b> .....	<b>11-10</b>
■ 11.5.2.1 Change in security level .....	11-10
■ 11.5.2.2 Encrypting messages .....	11-10
<b>11.5.3 Automated transaction logs</b> .....	<b>11-10</b>
□ 11.5.3.1 Automatic recording of data access .....	11-10
□ 11.5.3.2 Informing users of automated record keeping .....	fs 11-10
<b>11.5.4 Transmission of messages</b> .....	<b>11-10</b>
■ 11.5.4.1 Automatic protection of transmitted data .....	11-10

- 11.5.4.2 Reviewing messages ..... 11-10
- 11.5.4.3 Confirmation codes ..... 11-11

## **11.6 Documentation of security safeguards**

..... **11-11**

- 11.6.1 User documentation ..... 11-11
- 11.6.2 Design documentation ..... 11-11

## **11.7 Security training**

..... **11-11**

- 11.7.1 Initial training ..... 11-11
- 11.7.2 Minimize training for personnel ..... 11-11
- 11.7.3 Security management training ..... 11-11



# 11 System security

This section of the *Human Factors Design Guide* pertains to the human factors aspects of security safeguard features for new (or modified) facilities, systems, and equipment that are to be acquired and maintained by the FAA. Human factors considerations can enhance the security effectiveness and suitability of new or upgraded systems.

**Definition. Security safeguards** are the protective measures and controls that are prescribed to meet the security requirements specified for a system. Those safeguards may include but are not necessarily limited to: operational procedures, physical security, or hardware and software features.

The FAA Order 1600.54, FAA Automated Information Systems Security Handbook, and associated directives explain security safeguards associated with communication security, necessary provisions for classified information, and security safeguards such as Tempest requirements.

**Discussion.** From a system analysis viewpoint, "security safeguards" need to be thought of as a subsystem of any new operational system. The human component of any operational system or subsystem, as well as the security component need to be considered and technically integrated from the concept phase throughout the procurement and implementation phase.

The FAA modernization program increasingly relies on automated processing systems. New computer technologies make it possible for remote users to access large databases through communication networks. Telecommunications systems and Automated Information Systems (AIS) boundaries are becoming vague and are highly susceptible to interception, unauthorized access, exploitation, and hostile threats.

## 11.1 General design practice

This section defines the security architecture of the NAS and provides human factors guidelines for risk analysis, interface considerations, certification and accreditation activities, and security test and evaluation. Other general guidelines for system security are also addressed.

- **11.1.1 Integrated security safeguards.** For the overall NAS and the systems, subsystems, and equipment being acquired, security safeguards shall be designed as an integrated security architecture for the purposes of physical protection, administrative control, maintenance control (including diagnostic activities), and information integrity.

**Definition. Security architecture** is a subset of the overall system architecture that protects the automated system, telecommunication, physical, and informational assets



through denial of service and unauthorized (accidental or intentional) disclosure, modification, or destruction.

**Discussion.** Independent security safeguards can be protected, managed, operated, and maintained by clearly designating human responsibilities and communication requirements. The security safeguards will interface with management information, control, monitoring, and communications systems.

- **11.1.2 Risk analysis and security planning.** Human factors aspects of risk analysis and security planning shall include analysis of the security related functions, procedures, tasks relative to authorized personnel.

**Definition. Authorized personnel** are operators, maintainers, support or supervisory personnel, system administrators, and security personnel.

**Discussion.** FAA Order 1600.54 establishes the necessary overall risk analysis and security planning that apply to new FAA information systems. It addresses system security controls, verification, reviews (including design reviews and tests), certification of security safeguards, and development analysis studies.

- **11.1.3 Human-security safeguard interfaces.** Human-security safeguard interfaces shall: (1) facilitate (simplify) system operation and maintenance, (2) be compatible with the level of required protection for data and resources involved, and (3) ensure the system is protected from unauthorized activities, misuse, or abuse.

**Discussion.** Non-developmental items (NDI) and commercial-off-the-shelf (COTS) human-security safeguard interfaces must also be evaluated and conform to FAA Order 1600.54.

- **11.1.4 Accreditation and certification.** The accreditation and certification of FAA AIS shall conform to FAA Order 1600.54. Human factors guidelines of this section are to be complied with before accreditation and certification are given.

**Definitions. Accreditation** is the authorization and approval granted to an AIS or network to process sensitive data in an operational environment. **Certification** is the technical evaluation that supports the accreditation process and establishes the extent to which a particular computer system or network design and implementation meets a prespecified set of security requirements.

- **11.1.5 Security test and evaluation.** Test and evaluation activities shall be conducted by the contractor to verify that

equipment, software, and facility designs meet the security and associated human factors requirements.

- **11.1.6 Nonautomated security measures.** The human-system interface for nonautomated security measures shall be designed so that users routinely apply the protection mechanisms correctly.
- **11.1.7 Alarm for security safeguard failure.** Visual and auditory alarms shall warn the system administrator and affected users when a security safeguard fails.
- **11.1.8 Security incidents.** Systems shall be designed so that attempts to defeat or circumvent security safeguards are automatically detected and reported to security personnel. Security personnel shall be notified within a specified time in a manner that draws immediate attention to the incident (for example, a flashing light or an auditory alarm).
- **11.1.9 Reporting and tracking security incidents.** Security incidents should be reported to the appropriate FAA security office and tracked by the system to determine trends, to identify general problem areas and security needs, and to ensure implementation of appropriate procedures and protective measures.

## 11.2 Physical security and access control

Physical security addresses the application of physical barriers and control procedures as preventive measures or countermeasures against threats to resources (for example, automated assets, facilities, telephone lines, or information). Good physical access control takes into account threats to a protected area due to vandalism, theft, modification, or destruction. This section gives guidelines for regulating the physical access to FAA AIS, the facilities that house those systems, and other FAA assets.

The physical security provided to a facility and AIS is based upon the alternative protection measures derived from security risk and requirements analyses. Provisions for protection are to be built into systems, subsystems, facilities, and equipment work areas in accordance with the selected protection features and the security policies applicable to the NAS environment.

Physical security and access control requirements can be found in FAA Orders 1600.54B and 1600.6C.

- **11.2.1 Consider the users.** In addition to relevant FAA directives, the human's roles, tasks, and interfaces associated with the physical security protection scheme shall be considered in the selection of physical security features, systems, and equipment. Both authorized and unauthorized interactions with physical security features shall be considered when designing physical access.

**Examples.** Listed below are some of the physical security features that need to be addressed:

- a. Will fences or walls be used for the outermost perimeter?
  - b. Will entrances be staffed or not staffed?
  - c. If entrances are not staffed, what protective entrance device (such as cipher locks, card recognition, or biometric access) will be installed to maintain security?
  - d. Will security personnel monitor closed circuit and low-level light television, infrared detection systems, or alarms?
  - e. How will visitor access be handled?
  - f. How much redundancy in security features will be needed?
- **11.2.2 Remote monitoring.** Remote facilities shall be monitored, and any security incidents shall be automatically reported to FAA security or monitoring personnel.
  - **11.2.3 Automatic access control.** If appropriate, automated safeguards should be used to control and monitor access to facilities and automated systems. These safeguards may include access control systems such as smart cards or other authentication technologies described in section 11.3.3.
  - **11.2.4 Alarms.** Visual and auditory alarms shall be provided and monitored for the security of remote facilities. These alarms shall notify appropriate monitors and security personnel of any security breaches. False alarms shall be minimized in order for the monitoring personnel to maintain confidence in the alarm capability. The number of false alarms shall not negate the effectiveness of the alarms.
  - **11.2.5 Access control log.** Automatic control systems shall be capable of providing, in both hard copy and machine-readable format (for later analysis), the date, time, location, and user identity of each valid and invalid entry attempt, and the reason for denial of access for each invalid entry attempt.

The *FAA Automated Information Systems Security Handbook*, FAA Order 1600.54, requires that all FAA automated systems have and use a software user identification and authentication capability.

### 11.3 Identification and authentication

**Definitions. Identification** is the process that enables the security safeguards to recognize a user name (usually through a machine-readable name) as an identical match to a name previously listed in an authorized user file.

**Authentication** is the act of identifying and confirming the eligibility of a station, originator, or user to access specific categories of information. Authentication is a measure designed to provide protection against fraudulent

entry or transmissions by establishing the validity of a transmission, message, station, or originator.

**Authorization** is granting, to a user or user group, the right of access to a program, a process, or information.

### 11.3.1 General

- **11.3.1.1 Timeliness of the security administrator's tasks.** The authorization tasks of the system security administrator should be made as straightforward and responsive as possible to the needs or requirements of the operational and maintenance environment of the AIS. The tasks of changing the authentication and authorizations of personnel should be designed to meet the needs or requirements of maintenance and operations environments. These change processes, their security, their ease of performance, and their timing should be a subject of human factors testing and evaluation by the acquisition program office.
- **11.3.1.2 Task simplicity.** System designers and integrators shall ensure that the identification and authentication tasks for authorized users are straightforward, simple, and consistent with the protection levels of the information to be processed in the system.
- **11.3.1.3 Log on process.** The log on process associated with the security subsystem shall be completed before a user is able to select any operational options.
- **11.3.1.4 Log on prompts.** A log on process shall provide prompts for all user entries, passwords, and other data required to confirm user identity. A log on prompt shall be provided automatically upon terminal or system initialization without other user actions.
- **11.3.1.5 Log on delay.** If a user tries to log on to a system and the log on attempt is denied because of system unavailability, an advisory message should be displayed to tell the user what the system status is and when the system will become available.
- **11.3.1.6 Unsuccessful log on attempts.** The security safeguards should not allow more than three log on attempts. This implementation provides a margin for user error while continuing to protect the system from persistent attempts at illegitimate access. Unsuccessful attempts beyond the third should initiate an alarm for the system administrator or at the terminal or both.
- **11.3.1.7 Terminal and user-id "lock-out."** Security safeguards should automatically "lock-out" the terminal and make the user-id invalid after three unsuccessful log on attempts.
- **11.3.1.8 Log-on entry.** System designers shall minimize the number of times an authorized user has to input individual identification and authentication information (such as passwords). If possible, the number of times shall not exceed the one initial system log on process per working session.
- **11.3.1.9 Access protection.** The following security measures shall be taken to ensure that security and safety will not be

compromised by unauthorized access to an unattended workstation or console.

- a. An individual's single log-on password shall permit all access and data entry capabilities, from any workstation, that the individual has been authorized. The authorized individual is then responsible to protect his or her password and workstation in accordance with appropriate system and work area security policy.
- b. If an individual has authorization for access to sensitive information or for entry of critical data, then that individual's use of his or her password on any authorized workstation shall enable appropriate access.

**Discussion.** As an option, a pre-programmed protection of the sensitive information (such as a screen saver or "read only" mode) could automatically engage after an appropriate period of workstation disuse. The period would be established by policy and administered by the system and network administrators. After the established period, the system shall default to the pre-programmed protection that excludes all sensitive information and disables data entry capabilities until an authorized individual re-enters his or her password to again validate his or her authentication. The re-entry of a password will be prompted. Upon password authentication the system would continue the previous operation.

The attempted user shall be notified that the terminal is in a locked-out mode for security reasons, if the authentication is not successful (see section 11.3.1.7).

**Discussion.** If the system security policy permits an authorized user to continue after the delay, then a correct identification and authentication would be permissible upon prompting. If the new authentication is successful, the system would then prompt the new user with an option to continue at the previous operation or to select another applicable operational mode.

- c. The user shall be able to engage this protected "read only" or screen save mode by an input command without waiting for the delay period. Thus, the authorized individual user is always responsible to ensure that his or her workstation is in a protected mode at any time, however brief, when he or she vacates a workstation where sensitive or critical information is accessible.
- d. These same security measures and processes shall apply to any remote or network capabilities that can allow access to sensitive or critical information.

- e. If the protection required by a., b., c., and d. is not provided for a workstation where critical or sensitive information is processed, then that workstation area shall be physically secured or guarded so that sensitive or critical information can not be accessed by unauthorized personnel. Information classification levels and their respective physical requirements are detailed in FAA Order 1600.2 and 1600.54, Chapter 5).
- **11.3.1.10 Interface links to minimize authentications in networks.** System designers and integrators should consider techniques to minimize the frequency of user identification and authentication tasks in connecting networks. If possible, they should minimize the identification and authentication task to one initial log on for each user work session.
- **11.3.1.11 Additional authentication.** If additional authentication is necessary for higher access levels, auxiliary personalized techniques such as "hand shaking" should be considered as a means to ensure identification and authentication.

**Definition.** "Hand shaking" is a question and answer dialogue whereby the computer asks questions from a set that the user has previously established and for which only the individual knows the answers. Identical questions for each user are to be avoided.
- **11.3.1.12 Transparent control over user actions.** After an authorized user has logged on to a system with proper identification and authentication, security safeguards shall maintain the necessary control of a user's activities in a manner that is transparent to the user. Access control, as set up by the system administrator, shall only permit user activity that is compatible with the user's access level. The security system shall not interrupt authorized activities or intersperse additional authentication tasks on the user.
- **11.3.1.13 Continuous recognition of user identity.** If a user has been identified and authenticated, data access and change privileges that are authorized for that user shall continue throughout a work session.
- **11.3.1.14 Duress entries.** If the security level of the information to be processed or the system criticality warrants, system designers should consider a user duress capability that would alert security personnel to a duress situation.

### 11.3.2 Passwords

The composition, length, source, storage, and ownership of passwords used in FAA AIS are governed by FIPS PUB 112, *Standard for Password Usage*. Password protection mechanisms and management responsibility are to conform to FAA Order 1600.54.

**Discussion.** Security safeguard designers need to realize that random alphanumeric strings are equivalent to nonsense syllables which are very difficult for humans to

memorize or retain, especially if they have five or more characters. Though mnemonic techniques can assist learning, computer-generated passwords will contribute to human memory and input errors.

- **11.3.2.1 Changing passwords.** Users should be permitted to change their passwords consistent with the sensitivity or security level of the information being accessed.

**Discussion.** This capability allows users to adapt unique passwords that will minimize erroneous entries. Such a self-chosen capability allows users to make a change when compromise is suspected.

- **11.3.2.2 Process for changing passwords.** An individual shall not be able to change his or her password without first re-entering his or her current password. It is advisable that passwords be changed when the system administrator is available to offer assistance if a problem occurs. When a proper password change has been made, the new password shall automatically permit access to all information authorized.

**Discussion.** The design implementation of this security system software is that an unauthorized person can not establish a password from an unattended workstation. It prevents such access even when the workstation is abandoned during log on.

- **11.3.2.3 Password protection.** Training should be given to users to ensure that common passwords (such as "me", "66 Vette", and "ABC") or commonly known user data (such as addresses, names spelled backwards ("ydnA"), and user birth dates) are not used. Self-chosen passwords should be protected by security safeguards.
- **11.3.2.4 Recording of date and time of log on.** After a user logs on, the system shall automatically record the date and time of the log on.
- **11.3.2.5 User feedback.** Immediately after the user attempts to log on, the system shall provide feedback as to whether he or she is logged on or not.

### 11.3.3 Other identification and authentication technologies

Identification and authentication technologies other than password techniques are available and need to be considered. These technologies greatly reduce reliance on user memory. Usually, these technologies require additional interface processing for direct use in identification and authentication. Other technologies typically used include fingerprinting, retina scanning, smart cards, voice recognition, and signature recognition.

**Discussion.** One problem encountered with biometric techniques is false rejection errors. Although biomechanical authentication technologies are still evolving, there are some individuals who, for one reason

or another, cannot be consistently authenticated; these technologies still may to be considered.

## 11.4 Auditing

- **11.4.1 Monitoring user access.** The system shall provide an automated means to monitor and record which users access specially protected objects of the system. Actions of the system administrator, as a "super-user," also shall be monitored.

**Definition.** An **object** is a passive entity that contains or receives information. Access to an object potentially implies access to the information it contains. Examples of objects are records, pages, files, directories, and programs, as well as text, fields, processors, and printers.

- **11.4.2 Data reduction tools.** The system administrator shall be provided an automated capability to easily reduce audit data.
- **11.4.3 Auditing events or programs.** The system administrator shall be able to specify which time periods, types of events, and programs are to be audited.
- **11.4.4 Auditing users or security levels.** Security safeguards shall enable the system administrator to selectively audit the actions of any specific user or users based on individual identity or security level.

## 11.5 Information and data protection

This section gives guidelines for the protection of classified data, automated transaction logs, and the transmission of messages.

### 11.5.1 General

- **11.5.1.1 Automated security measures.** Automated security safeguards shall be provided to protect data security and system integrity to the extent possible.

**Discussion.** The goal of data protection is to minimize data loss resulting from potentially destructive failures, user errors, and unauthorized access. Even careful, conscientious users will sometimes make mistakes, and the user interface needs to mitigate the consequences of those mistakes.

- **11.5.1.2 Integrity of data.** Security safeguards shall minimize the risk of unauthorized modifications of data files or system control data.
- **11.5.1.3 Warning of threats to security.** Messages or alarm signals shall be provided to warn users and system administrators of potential threats to data security. The number of false alarms shall not negate the effectiveness of the alarms.



- **11.5.1.4 "Read-only" status.** A "read-only" status indication shall be provided to users not authorized to change displayed data. Authorization for "read-only" data may require logging onto the system when the information warrants such protection (such as classified data).
- **11.5.1.5 Degraded system warning.** The system shall generate an alarm when performance of components has degraded beyond established thresholds.

### 11.5.2 Classified data protection

Classified data must to be processed only in approved, secure areas as defined in FAA Order 1600.54. A computer room that has approval to process classified information is to be designed as a "closed area," in accordance with FAA Order 1600.2C.

- **11.5.2.1 Change in security level.** Users shall be given both visual and auditory alarms when a change in the security level has occurred.
- **11.5.2.2 Encrypting messages.** If it is necessary to transmit classified or sensitive data over insecure communication channels, automatic encryption shall be provided. This encryption shall be transparent to the user. All requirements for communication security (COMSEC) and the use of cryptographic systems with the FAA are defined in FAA Order 1600.8C.

### 11.5.3 Automated transaction logs

- **11.5.3.1 Automatic recording of data access.** If logs of data access are needed, security safeguards should keep those records automatically. Users should not be responsible for critical record keeping actions.
- **11.5.3.2 Informing users of automated record keeping.** Users should be informed concerning the nature and purpose of automated recording of individual actions.

**Discussion.** This may be accomplished by various methods such as a security briefing or a message at the time of log on.

### 11.5.4 Transmission of messages

- **11.5.4.1 Automatic protection of transmitted data.** Automated measures shall be provided to protect data during transmission (for example, encryption) until the data have been received.
- **11.5.4.2 Reviewing messages.** Users shall be provided a means of reviewing outgoing messages and their security provisions (for example, its security classification) before transmission.

## 11.6 Documentation of security safeguards

- **11.5.4.3 Confirmation codes.** If a user must confirm the identity of a message source, computer aids such as computer-generated confirmation codes should be provided.

This section gives guidelines for documentation of the security safeguards, their interactions with other systems, the AIS facilities, and the protection of these documents.

- **11.6.1 User documentation.** The user documentation shall provide guidelines for security safeguard use, a description of how security safeguards interact with each other, and a description of the protective mechanisms they employ in order to facilitate maintenance of the security system.
- **11.6.2 Design documentation.** Documentation providing a description of the manufacturer's human-security safeguards interface shall be available for non-developmental items and commercial-off-the-shelf equipment. If the security safeguards are composed of distinct modules, the interfaces between these modules shall also be described.

## 11.7 Security training

All personnel who access computer systems, including users, supervisors, maintenance technicians, programmers, and system administrators need to be given training. This section contains general guidelines concerning

Specific details concerning AIS security training and awareness can be found in FAA Order 1600.54B, Chapter 13.

- **11.7.1 Initial training.** All personnel who use computers should receive initial security training concerning the correct operation of specific security-related features.

**Discussion.** The initial training session for all personnel may consist of topics such as log on and log off procedures, the "dos" and "don'ts" of computer equipment and disks, and other similar basic ideas.

- **11.7.2 Minimize training for personnel.** System designers shall minimize the need for training of authorized users and key security personnel.
- **11.7.3 Security management training.** Key management personnel should receive specialized training sessions on security management.

**Discussion.** The training sessions for security management can include:

- a. an overview of the major interfaces,
- b. common threats to and vulnerabilities of systems and their impact on system operation,

- c. the objectives, roles and responsibilities, life cycle management, security measures, contingency and emergency plans, and incident and vulnerability reports given in the system operating instructions, and
- d. the fact that security is the responsibility of everyone who has authorized access.

## Section 12 contents

<b>12 Personnel safety</b> .....	<b>12-1</b>
<b>12.1 General</b> .....	<b>12-1</b>
▪ 12.1.1 Safety factors .....	12-1
<b>12.2 Work space safety</b> .....	<b>12-1</b>
<b>12.2.1 General</b> .....	<b>12-1</b>
▪ 12.2.1.1 Hazard alerting or alarm devices .....	12-1
▪ 12.2.1.2 Location .....	12-1
▪ 12.2.1.3 Redundant hazard alerting or alarm devices .....	12-1
▪ 12.2.1.4 Physical barriers .....	12-1
▪ 12.2.1.5 Obstruction-free .....	12-2
▪ 12.2.1.6 Emergency door and exit design and construction .....	12-2
▪ 12.2.1.7 Nonskid surfaces .....	12-2
▪ 12.2.1.8 Illumination .....	12-3
<b>Exhibit 12.2.1.8</b> Specific task illumination requirements .....	12-3
<b>12.2.2 Platforms, ramps, stairs, ladders, and handholds</b> .....	<b>12-3</b>
▪ 12.2.2.1 Self-locking devices .....	12-3
▪ 12.2.2.2 High centers of gravity .....	12-3
▪ 12.2.2.3 Safety measures .....	12-3
▪ 12.2.2.4 Toe board or guard screen .....	12-4
▪ 12.2.2.5 Safety mesh .....	12-4
▪ 12.2.2.6 Telescoping ladders .....	12-4
□ 12.2.2.7 De-icing ladders and steps .....	12-4
▪ 12.2.2.8 Handholds .....	12-4
▪ 12.2.2.9 Nonfixed handholds .....	12-4
□ 12.2.2.10 Fixed handholds .....	12-4
<b>12.3 Equipment-related safety</b> .....	<b>12-4</b>
▪ 12.3.1 Hazardous operations .....	12-4
▪ 12.3.2 Accessibility .....	12-5

■ 12.3.3 Test equipment stability .....	12-5
■ 12.3.4 Equipment with wheels .....	12-5
■ 12.3.5 Mechanically stored energy devices .....	12-5
■ 12.3.6 Safety features .....	12-5
□ 12.3.7 Equipment coloring .....	12-5
<b>12.4 Electrical hazards</b> .....	<b>12-5</b>
<b>Exhibit 12.4 Shock current intensities and their effects</b> .....	12-6
<b>12.4.1 General</b> .....	<b>12-6</b>
■ 12.4.1.1 Protection from electric shock .....	12-6
■ 12.4.1.2 Rubber insulating equipment .....	12-7
■ 12.4.1.3 Selection of rubber insulating equipment .....	12-7
<b>Exhibit 12.4.1.3 Proof test values for protective gloves</b> .....	12-7
■ 12.4.1.4 Static charge buildup .....	12-7
■ 12.4.1.5 Fail-safe .....	12-7
■ 12.4.1.6 Electrical conductors .....	12-8
■ 12.4.1.7 Power .....	12-8
■ 12.4.1.8 Covers .....	12-8
■ 12.4.1.9 Bypassable interlocks .....	12-8
<b>Exhibit 12.4.1.9 An interlock switch</b> .....	12-8
■ 12.4.1.10 Nonbypassable interlocks .....	12-8
■ 12.4.1.11 Interlock override .....	12-8
■ 12.4.1.12 Medium voltage guarding .....	12-8
■ 12.4.1.13 High voltage guarding .....	12-8
■ 12.4.1.14 Guarding radio frequency (rf) voltages .....	12-8
■ 12.4.1.15 Explosion-proof equipment .....	12-9
■ 12.4.1.16 Plugs and receptacles .....	12-9
■ 12.4.1.17 "Hot" Leads .....	12-9
■ 12.4.1.18 Design and location of electrical installations and electrical utilization .....	12-9
<b>12.4.2 Switches</b> .....	<b>12-9</b>
■ 12.4.2.1 Main-power switches .....	12-9
■ 12.4.2.2 Main-power switch location .....	12-9
■ 12.4.2.3 Physical protection at main-power switches .....	12-9
■ 12.4.2.4 Arc prevention .....	12-9
■ 12.4.2.5 Safety switches .....	12-9
□ 12.4.2.6 Switch box safety .....	12-9
<b>12.4.3 Discharging devices</b> .....	<b>12-10</b>
■ 12.4.3.1 Bleeders .....	12-10

■ 12.4.3.2 Shorting rods .....	12-10
■ 12.4.3.3 Removing power .....	12-10
<b>Exhibit 12.4.3.3</b> Automatic shorting bar .....	12-10
■ 12.4.3.4 Shorting rod storage .....	12-11
<b>12.4.4 Grounding</b> .....	<b>12-11</b>
■ 12.4.4.1 Same common ground .....	12-11
■ 12.4.4.2 Path to ground .....	12-11
■ 12.4.4.3 Grounding techniques .....	12-11
■ 12.4.4.4 Nonconductive finishes .....	12-11
■ 12.4.4.5 Rivet connections .....	12-11
□ 12.4.4.6 Equipment grounding .....	12-11
<b>Exhibit 12.4.4.6</b> Equipment grounding .....	12-12
■ 12.4.4.7 Ground connections .....	12-12
■ 12.4.4.8 Hinges and slides .....	12-12
■ 12.4.4.9 Panels and doors .....	12-12
■ 12.4.4.10 Ground wire in the cable .....	12-12
■ 12.4.4.11 Cable shields as grounds .....	12-12
■ 12.4.4.12 Test equipment .....	12-12
<b>12.4.5 Electrical tools and self-powered equipment</b> .....	<b>12-13</b>
■ 12.4.5.1 Insulation of tools .....	12-13
■ 12.4.5.2 Electrical cords .....	12-13
■ 12.4.5.3 Exposed surfaces of tools .....	12-13
■ 12.4.5.4 Same voltage .....	12-13
<b>12.5 Physical hazards</b> .....	<b>12-13</b>
<b>12.5.1 General</b> .....	<b>12-13</b>
■ 12.5.1.1 Protective devices .....	12-13
■ 12.5.1.2 Carried units .....	12-13
■ 12.5.1.3 Countersunk screws .....	12-13
■ 12.5.1.4 Exposed edges .....	12-13
<b>Exhibit 12.5.1.4 (a)</b> Rolling edges of sheets less than 0.5 mm (0.02 in) thick .....	12-13
<b>Exhibit 12.5.1.4 (b)</b> Rounding exposed edges 0.5 up to 3.0 mm (0.02 up to 0.12 in) thick .....	12-14
<b>Exhibit 12.5.1.4 (c)</b> Rounding exposed edges 3.0 up to 6.4 mm (0.12 up to 0.25 in) thick .....	12-14

<b>Exhibit 12.5.1.4 (d)</b> Rounding of exposed edges 6.4 mm (0.25 in) thick or greater .....	12-14
▪ 12.5.1.5 Exposed corners .....	12-14
<b>Exhibit 12.5.1.5 (a)</b> Requirements for rounding of corners less than 25 mm (1.0 in) thick .....	12-14
<b>Exhibit 12.5.1.5 (b)</b> Requirements for rounding of corners greater than 25 mm (1.0 in) thick .....	12-15
□ 12.5.1.6 Projecting components .....	12-15
▪ 12.5.1.7 Latches .....	12-15
▪ 12.5.1.8 Levers, cranks, hooks, and controls .....	12-15
▪ 12.5.1.9 Burr free .....	12-15
▪ 12.5.1.10 Capped bolt threads .....	12-15
□ 12.5.1.11 Air-exhaust openings .....	12-15
<b>12.5.2 Guards, caps, and shields</b> .....	<b>12-15</b>
▪ 12.5.2.1 Avoiding accidental contact .....	12-15
▪ 12.5.2.2 Enclosure of hazardous components .....	12-15
▪ 12.5.2.3 Ventilation holes .....	12-16
▪ 12.5.2.4 High-temperature units of equipment .....	12-16
□ 12.5.2.5 Guard design .....	12-16
<b>12.6 Liquid and gas hazards</b> .....	<b>12-16</b>
▪ 12.6.1 Releasing gases .....	12-16
▪ 12.6.2 Distinctive types .....	12-16
▪ 12.6.3 Automatic shutoffs .....	12-16
▪ 12.6.4 Avoid spraying fluids .....	12-16
▪ 12.6.5 Mercury .....	12-16
▪ 12.6.6 OSHA safety criteria for hazardous gases and liquids .....	12-16
<b>12.7 Toxic hazards</b> .....	<b>12-16</b>
▪ 12.7.1 Exposure .....	12-17
▪ 12.7.2 Carbon monoxide .....	12-17
▪ 12.7.3 Cadmium oxide fumes .....	12-17
▪ 12.7.4 Fumes from batteries .....	12-17
▪ 12.7.5 Safety for toxic chemicals and materials .....	12-18
▪ 12.7.6 Asbestos .....	12-18
<b>12.8 Radiation hazards</b> .....	<b>12-18</b>
▪ 12.8.1 Radioactive materials .....	12-18

■ 12.8.2 Radium .....	12-18
■ 12.8.3 Ionizing radiation exposure .....	12-18
■ 12.8.4 Microwave and radio frequency radiation .....	12-18
<b>12.9 Protection from special chemicals</b> .....	<b>12-18</b>
■ 12.9.1 Eye Protection .....	12-18
■ 12.9.2 Gloves and aprons .....	12-19
■ 12.9.3 Large-sized service facilities .....	12-19
■ 12.9.4 Small-sized service facilities .....	12-19
■ 12.9.5 Cleaning solvents .....	12-19
■ 12.9.6 Polychlorinated Biphenyls (PCBs) .....	12-19
■ 12.9.7 Carcinogens .....	12-19
<b>12.10 Temperature hazards</b> .....	<b>12-19</b>
■ 12.10.1 "Touch temperature" contact .....	12-19
<b>Exhibit 12.10.1</b> Upper and lower temperature limit ranges .....	12-20
■ 12.10.2 Perforation size .....	12-20
<b>12.11 Fire protection</b> .....	<b>12-20</b>
■ 12.11.1 Nonflammable enclosures .....	12-20
□ 12.11.2 Flammable materials .....	12-20
■ 12.11.3 Flammable gases .....	12-20
■ 12.11.4 Fire extinguishers .....	12-20
■ 12.11.5 Selection of fire extinguishers .....	12-20
■ 12.11.6 Fire protection criteria .....	12-21
<b>12.12 Noise hazards</b> .....	<b>12-21</b>
■ 12.12.1 General noise levels .....	12-21
■ 12.12.2 Noise criteria .....	12-21
■ 12.12.3 Extreme quiet areas .....	12-22
■ 12.12.4 Small office spaces and special areas .....	12-22
■ 12.12.5 Operational areas .....	12-22
■ 12.12.6 Equipment areas .....	12-22
■ 12.12.7 High noise, remote areas .....	12-22
■ 12.12.8 Occupational noise exposure and control .....	12-22
<b>Exhibit 12.12.8</b> Permissible noise exposure .....	12-23



<b>12.13 Explosion and implosion hazards</b>	.....	<b>12-23</b>
□ 12.13.1 CRT conformance	.....	12-23
■ 12.13.2 Terminal end of CRT	.....	12-23
■ 12.13.3 Explosion	.....	12-23
□ 12.13.4 Minimizing risk of explosion	.....	12-24
■ 12.13.5 Explosion causing gases	.....	12-24
<b>12.14 Radiant energy hazards</b>	.....	<b>12-24</b>
<b>12.14.1 Ultraviolet radiant energy (200-315 nm)</b>	.....	<b>12-24</b>
■ 12.14.1.1 Exposure limit	.....	12-24
<b>Exhibit 12.14.1.1</b> Exposure limit for ultraviolet radiant energy (200 to 315 nm)	.....	12-25
<b>12.14.2 Near-ultraviolet radiant energy (315-400 nm)</b>	.....	<b>12-24</b>
■ 12.14.2.1 Exposure duration greater than 1000 seconds	.....	12-24
■ 12.14.2.2 Exposure duration less than 1000 seconds	.....	12-24
<b>12.14.3 Visible and near-infrared radiant energy (400-1400 nm)</b>	.....	<b>12-24</b>
<b>Exhibit 12.14.3</b> Relative contribution of different wavelengths to luminance--the luminosity function	.....	12-26
■ 12.14.3.1 Exposure of the eye	.....	12-26
<b>Exhibit 12.14.3.1</b> Maximum safe exposure to 400-1400 nm radiant energy	.....	12-26
■ 12.14.3.2 Exposure of skin	.....	12-27
■ 12.14.3.3 Removing infrared	.....	12-27
□ 12.14.3.4 Maximum display	.....	12-27
<b>Exhibit 12.14.3.4</b> Estimation of permissible image luminance	.....	12-27

<b>12.14.4 Far-infrared radiant energy (1400 10<sup>6</sup> nm)</b>	.....	<b>12-27</b>
▪ 12.14.4.1 Short term exposure	.....	12-27
▪ 12.14.4.2 Chronic exposure	.....	12-28
<b>12.14.5 Microwave radiant energy (10<sup>7</sup>-10<sup>11</sup> Hz)</b>	.....	<b>12-28</b>
▪ 12.14.5.1 Exposure limit	.....	12-28
<b>12.15 Laser hazards</b>	.....	<b>12-28</b>
▪ 12.15.1 Laser radiation	.....	12-28
▪ 12.15.2 Laser exposure limits	.....	12-28
▪ 12.15.3 Eye protection from laser lights	.....	12-28
▪ 12.15.4 Labeling of laser protective goggles	.....	12-28
▪ 12.15.5 Qualified laser equipment operators	.....	12-29
▪ 12.15.6 Laser alignment	.....	12-29
▪ 12.15.7 Personnel laser safety	.....	12-29
<b>12.16 Safety labels and placards</b>	.....	<b>12-29</b>
▪ 12.16.1 Warning labels and placards	.....	12-29
▪ 12.16.2 Label and placard design	.....	12-29
<b>Exhibit 12.16.2</b> Label and placard layout--two panel sign with optional symbol panel	.....	12-30
▪ 12.16.3 Label and placard design classifications and specifics	.....	12-29
▪ 12.16.4 Label and placard placement	.....	12-30
▪ 12.16.5 Illumination for warning labels and placards	.....	12-30
▪ 12.16.6 Wording for medium voltage labels and placards	.....	12-30
▪ 12.16.7 Wording for high voltage labels and placards	.....	12-31
▪ 12.16.8 Microwave or rf radiation warning labels and placards	.....	12-31
▪ 12.16.9 X radiation shield labels and placards	.....	12-31
▪ 12.16.10 Ionizing radiation symbols	.....	12-31
▪ 12.16.11 Laser warning labels and placards	.....	12-31
▪ 12.16.12 Line identification	.....	12-31
▪ 12.16.13 Electrical labels and placards	.....	12-31
▪ 12.16.14 Center of gravity	.....	12-31
▪ 12.16.15 Weight labels	.....	12-32
▪ 12.16.16 Weight lifting capacity	.....	12-32
▪ 12.16.17 Identifying hazardous areas	.....	12-32

- 12.16.18 Identifying hand grasp areas ..... 12-32
- 12.16.19 "NO-STEP" labels or placards ..... 12-32

## 12 Personnel safety

Human factors design guidelines that enhance the safety of FAA maintenance personnel are discussed in this section. Section 6, Designing equipment for maintenance, section 9, Workplace design, and section 13, Environment, also contain safety guidelines specific to their respective domains.

### 12.1 General

This general section discusses safety factors that are derived from human engineering and from application of military safety considerations and from FAA and OSHA health and safety considerations. The latter have precedence.

- **12.1.1 Safety factors.** As part of facility and equipment design, safety factors shall be given major consideration, including, as a minimum, the representative safety guidelines herein, together with the effective application of the human engineering guidelines in other sections of this document. Safety factors are also determined from the application of MIL-STD-822B to the acquisition program and from FAA Order 3900.19(B), OSHA 29 CFR 1910 and 1926 as they apply to the program. In the area of safety and health OSHA and FAA documents have precedence.

### 12.2 Work space safety

Guidelines addressing general work space safety including the safety of maintainers using platforms, ramps, stairs, ladders, and handholds are given in this section.

#### 12.2.1 General

- **12.2.1.1 Hazard alerting or alarm devices.** A hazard alerting or alarm device shall be provided to warn personnel of impending danger or existing hazards such as fire, radio frequency or X radiation, or the presence of combustible or asphyxiating gas. 29 CFR 1910.165 shall govern employee alarms for fire or other hazards that require escape (see also 29 CFR 1910.165 Appendixes A, B, and C for guidelines).
- **12.2.1.2 Location.** Hazard alerting or alarm devices shall be located where the people who must take corrective action can easily distinguish them.
- **12.2.1.3 Redundant hazard alerting or alarm devices.** Redundant hazard-alerting devices of different types, for example, a light and a bell, shall be required if ambient noise could mask the audible alarm, or if the warning light could not be seen in the ambient illumination. Tactile devices may be used to alert employees who would not otherwise be able to recognize audible or visual alarms.
- **12.2.1.4 Physical barriers.** Where feasible, physical barriers (for example, safety chains, guards, shields, or walls) shall be provided in addition to safety labels, placards, and signs, to prevent contact with hazards, such as moving parts of machinery.

Fixed and portable power tools shall be guarded in accordance with 29 CFR 1910.212 -247. Live electrical parts operating at 50 or more volts shall be guarded in accordance with 29 CFR 1910.303 (b)(2). Floor and wall openings shall be guarded in accordance with 29 CFR 1910.23 (see paragraphs 9.3.3.4.2 and 9.3.4.6.3). Power transmission apparatus shall be guarded in accordance with 29 CFR 1910.219.

- **12.2.1.5 Obstruction-free.** Work spaces shall be free of obstructions that could cause injury to personnel either through accidental contact with the obstruction or because the obstruction forces the maintainer to adopt an awkward position. In accordance with 29 CFR 1910.22, all workplaces shall be kept clean and dry and shall not have obstructions where they would cause a hazard.
- **12.2.1.6 Emergency door and exit design and construction.** Emergency doors and exits shall be designed and constructed so that they:
  - a. are simple to operate,
  - b. are readily accessible,
  - c. are clearly designated,
  - d. are unobstructed,
  - e. are simple to locate and operate in the dark,
  - f. are capable of being opened in 3 sec or less,
  - g. require 44 to 133 N (10 to 30 lb) of operating force to open,  
**Definition.** The symbol **N** is a metric term for the force measure called a **Newton**. One pound force in the English measurement system is equal to 4.4482 Newton (1 lbf = 4.4482 N).
  - h. permit exit by one person in 5 sec or less, and
  - i. do not in themselves, or in their operation, constitute a safety hazard.  
**Note.** This rule is the same as rule 9.3.4.4.2. Means of egress and exit shall comply with 29 CFR 1910.35 -40.
- **12.2.1.7 Nonskid surfaces.** Stairs, ramps, platforms, and catwalks shall have skid-proof flooring, stair, and step treads. Where applicable, surfaces shall be treated with nonskid material that conforms to MIL-W-5044 and that is applied in accordance with MIL-W-5050 (see paragraph 9.3.3.3.1).

- 12.2.1.8 Illumination.** Adequate illumination shall be provided for all work spaces. Recommended and minimum levels are given in exhibit 12.2.1.8 (see paragraph 13.4.2.2).

**Exhibit 12.2.1.8** Specific task illumination requirements

Illumination levels			
Work area or type of task	Lux* (ft-C)		
	Recommended	Minimum	
Corridors	215 (20)	110 (10)	
Emergency lighting	NA **	30 (3)	
Hallways	215 (20)	110 (10)	
Passageways	215 (20)	110 (10)	
Repair work: general	540 (50)	325 (30)	
instrument	2155 (200)	1075 (100)	
Service areas, general	215 (20)	110 (10)	
Stairways	215 (20)	110 (10)	
* As measured at the task object or 760 mm (30 in) above the floor.			
** Recommended illumination is the level appropriate to the task.			

**12.2.2 Platforms, ramps, stairs, ladders, and handholds**

Section 9 treats these topics in some detail. This section provides additional safety considerations. These topics including scaffolding are covered in detail in 29 CFR 1910.21 -30.

- 12.2.2.1 Self-locking devices.** Self-locking or other fail-safe devices shall be incorporated on elevating stands, work platforms, and "draw bridges" to prevent accidental or inadvertent collapsing or falling. Safety requirements of 29 CFR 1910.21 -30 shall also apply to platforms and scaffolding.
- 12.2.2.2 High centers of gravity.** Platforms that have a high center of gravity shall have anchors or outriggers for stability.
- 12.2.2.3 Safety measures.** Guardrails, safety bars, or chains shall be installed around platforms and across stair or step openings of ledges, catwalks, and the like. These guards shall be

1.1 m (42 in) above the standing surface. An additional guardrail shall also be provided between the platform and the top guardrail, safety bar, or chain. These top guardrails shall be no more than 1.1 m (42 in.) and no less than 91 cm (36 in.) from the platform. Safety chains shall only be used where it is not feasible to install guardrail or safety bars.

- **12.2.2.4 Toe board or guard screen.** A toe board of 10 cm (4 in) to 15 cm (4 in) shall be used to guard floor openings or a guard screen shall extend from the floor base to the intermediate rail.

**Note.** OSHA regulation 29 CFR 1910.23 (e) permits a 102 mm (4 in) toeboard as a minimum.

**Discussion.** The guard screen is used to prevent a person who falls on the platform from falling from the platform. It can also prevent most tools, parts, and equipment from falling from the platform. toe boards are intended to prevent tools, parts, and equipment from falling as well as to prevent the worker's foot from slipping off the edge of the platform.

- **12.2.2.5 Safety mesh.** Screen or safety mesh shall be installed on the underside of open gratings, platforms, or flooring surfaces where there is a possibility that small tools, parts, or debris may fall through the grating onto maintainers or equipment beneath the platform.
- **12.2.2.6 Telescoping ladders.** Adequate finger clearance shall be provided between the moving parts of telescoping ladders.
- **12.2.2.7 De-icing ladders and steps.** Ladders and steps should be designed so they can be de-iced with hot water or steam.
- **12.2.2.8 Handholds.** Handholds shall be furnished where needed to assist maintainers in climbing onto a platform or in performing the intended maintenance tasks from the platform (same as paragraph 9.3.3.4.4).
- **12.2.2.9 Nonfixed handholds.** When a flat surface is desired, handholds shall fold or telescope so they are concealed or flush with the surface except when they are being used. Folding hand grips shall remain securely folded when not in use and maintainers shall not need tools to open them.
- **12.2.2.10 Fixed handholds.** Handholds should be fixed except when a flat surface is desired.

## 12.3 Equipment-related safety

Safety factors need to be a major part of equipment design. This section gives guidelines to protect the maintainer from possible injury when using or working with hazardous equipment.

- **12.3.1 Hazardous operations.** The operation of switches or controls that initiate hazardous operations (for example, equipment-moving devices) shall require the prior operation of a

related or locking control. When practical, the critical position of such a control shall activate a visual and auditory warning device in the affected work area.

- **12.3.2 Accessibility.** Units of equipment shall be located and mounted so that they are accessible to the maintainer with minimal danger from electrical charge, heat, moving parts, radiation, or other hazards (see also paragraph 12.4.1.1).
- **12.3.3 Test equipment stability.** Equipment, particularly portable equipment such as maintenance stands, tables, benches, platforms, and ladders, shall be designed for maximum stability and shall meet OSHA requirements.
- **12.3.4 Equipment with wheels.** Equipment with wheels shall be designed to maximize stability and safety when it is moved on ramps or inclines.

**Discussion.** Ramps and inclines change the equipment's center of gravity. The lower wheels bear a majority of the weight. With heavier equipment, this may mean that weight is concentrated enough to exceed allowable ramp loads. Shifting the center of gravity also increases the risk that equipment will overturn.

- **12.3.5 Mechanically stored energy devices.** Maintainers shall be protected from mechanical devices capable of storing energy, such as springs, levers, and torsion bars. A means shall be provided to release the stored energy (see also paragraphs 6.5.9.1 and 6.7.3.4.4).

**Discussion.** Protection can be achieved by shielding the stored energy devices. The release of stored energy can be achieved by a device that automatically releases the energy or by a device or procedure that permits the maintainer to safely release the energy.

- **12.3.6 Safety features.** Where stored energy devices are necessary, safety features such as removal tabs, lockouts, and warning placards shall be provided (see also sections 6.5.9 and 12.16).
- **12.3.7 Equipment coloring.** Equipment designed for safety, protective, or emergency functions should be colored in accordance with MIL-STD-1473.

## 12.4 Electrical hazards

The principle electrical hazard is shock. The effects of electric shock depend on the body's resistance, the current path through the body, the duration of the shock, the amount of current and voltage, the frequency of the alternating current, and the individual's physical condition. The most critical determinant of injuries is the amount of current conducted through the body. Besides the obvious risk of burns and injuries to the nervous system, electric shock can produce involuntary muscular reactions that injure people. Exhibit 12.4 gives the typical effects of various current intensities. All electrical systems of



30 volts or more are potential shock hazards. Research reveals that most shock deaths result from contacts with electrical systems ranging from 70 to 500 volts. Under extraordinary circumstances, even voltages below 30 volts can cause injury.

**12.4.1 General**

The two basic types of safety switches for preventing electric shock are interlocks and main-power switches.

**Definitions.**

**Interlocks** are devices (for example, switches) connected with a cover, shield, or case that disable the associated internal hazard (usually electrical) when the cover, shield, or case is opened. OSHA regulations discuss lockout and tagout procedures to be used in the workplace during maintenance or operations to protect from electrical hazards. A **lockout** uses a mechanical mean to disable a control or switch in its safe position (for example, electricity disconnected) and to prevent its activation without the use of undue force or tools. **Tagouts** are tags that are attached to a control or place of hazard associated with an ongoing mode of operation or maintenance (same as introduction in section 6.5.9).

**Exhibit 12.4** Shock current intensities and their effects

Current (mA)	Effects
Less than 1	Usually not felt (no sensation)
1-2	There is a sensation of shock.
3-15	Painful shock occurs, but the individual can still let go.
16-20	Painful shock occurs and the individual may not be able to let go because control of the immediately adjacent muscles is affected.
21-50	Very painful shock occurs plus severe muscular contractions. Breathing typically becomes difficult.
51-100	Ventricular fibrillation (a heart condition that may result in death).
101-200	Same as above except that the results are certain.
201 and over	Severe burns occur as well as muscle contractions so severe that the other muscles stop the heart during the duration of the shock.

- 12.4.1.1 **Protection from electric shock.** Maintainers shall be protected from accidental contact with voltages in excess of 30 volts ac or dc by interlocks, grounding, and other protective devices.

**Discussion.** Human protection from hazardous conditions with unexpected energy or release of stored energy is treated in 29 CFR 1910.301 -308, 331 -335, and 399. The OSHA regulation 29 CFR 1910.333 (b)(2)(iii)(A) requires the simultaneous use of both tagout and lockout in the workplace; 29 CFR 1910.333 (b)(2)(ii)(B) states that interlocks shall not be the sole mean of de-energizing circuits of equipment and are not substitutes for lockout and tagout procedures and practice.

- **12.4.1.2 Rubber insulating equipment.** To help ensure the safety of the maintainer, insulated rubber gloves and live line tools shall be provided for personnel working on or near energized power circuits and equipment rated over 600 volts.
- **12.4.1.3 Selection of rubber insulating equipment.** Rubber protective equipment shall be selected in accordance with the voltages and equipment maintained. Exhibit 12.4.1.3 provides proof test for various classes of protective gloves. 29 CFR 1910.137 specifies that the rubber protective equipment for electrical workers conform to ANSI standards. (See 29 CFR 1910.137 for testing of applicable ANSI standards). FAA Order 3900.19B 145B specifies that new rubber gloves shall be tested before used and at a minimum each 12 months. Reissued rubber glove shall be retested within 9 months of issue.

**Exhibit 12.4.1.3** Proof test values for protective gloves

Class of glove	Maximum proof test current (mA)				
	3 min. proof test voltage RMS (Volts)	10.5" glove	14" glove	16" glove	18" glove
Class 0	5,000	8	12	14	16
Class I	10,000	-	14	16	18
Class II	20,000	-	16	18	20
Class III	30,000	-	18	20	22
Class IV	40,000	-	-	22	24

- **12.4.1.4 Static charge buildup.** Equipment design shall prevent static charge buildup or provide a method to discharge it.

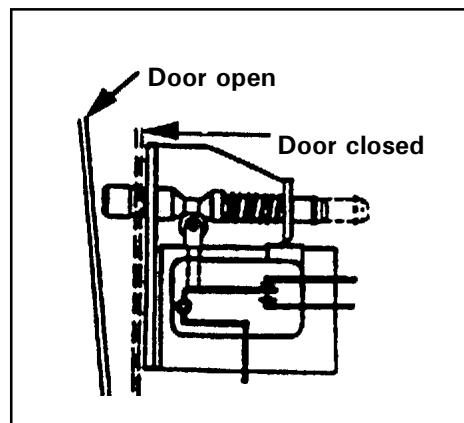
**Discussion.** The effects of electrostatic buildup can range from minor discomfort (the shock from walking across a new carpet and touching a metal object) to physical injury.

- **12.4.1.5 Fail-safe.** The design and development of all electronic equipment shall provide fail-safe features for safety of personnel during installation, operation, maintenance, and repair or interchanging of a complete equipment assembly or component parts.

- **12.4.1.6 Electrical conductors.** Electrical conductors with which maintainers might come into contact during maintenance activities shall be insulated.
- **12.4.1.7 Power.** Maintainers shall be provided a means for removing power while they are installing, replacing, or repairing components or equipment.
- **12.4.1.8 Covers.** Grounded or nonconductive protective covers shall be provided for all electrical equipment.

- **12.4.1.9 Bypassable interlocks.** Doors, covers, or lids that provide access to voltage in the range of 70 to 500 volts shall have a bypassable interlock. Equipment that has been bypassed shall conform to 29 CFR 1910.333 (c)(10). Exhibit 12.4.1.9 shows an example of such an interlock.

**Exhibit 12.4.1.9** An interlock switch



- **12.4.1.10 Nonbypassable interlocks.** Doors, covers or lids that provide access to voltages in excess of 500 volts or allow exposure to microwave and radio frequency radiation in excess of 300 KHz shall have nonbypassable interlocks.
- **12.4.1.11 Interlock override.** If a task requires that a maintainer work on hazardous equipment that is equipped with a disabling interlock, the equipment shall have an interlock override that permits manual bypassing or overriding of the interlock when the case or cover is open. This override shall automatically reset to the safety-protection position when the cover or case is replaced (same as paragraph 6.5.9.2 for covers and 6.6.5.2 for cases). OSHA 29 CFR 1910.333 requires that only qualified personnel shall be allowed to disable an interlock.
- **12.4.1.12 Medium voltage guarding.** If contacts, terminals, or other similar devices having voltages between 70 and 500 volts ac or dc with respect to ground are exposed, they shall be guarded from accidental contact by maintainers (see paragraph 12.16.6 concerning wording for medium voltage labels and placards).
- **12.4.1.13 High voltage guarding.** Systems or equipment operating in excess of 500 volts ac or dc shall be completely enclosed (see paragraph 12.16.7 concerning wording for high voltage labels and placards).
- **12.4.1.14 Guarding radio frequency (rf) voltages.** Transmitter output terminals, antennas, and other devices that carry sufficient rf voltage to burn or injure maintainers shall be guarded from accidental contact.

- **12.4.1.15 Explosion-proof equipment.** All electrical equipment that will be used near flammable gases or vapors shall be explosion-proof. This equipment shall also be certified or listed by a nationally recognized testing laboratory recognized by OSHA (for example, Underwriters Laboratory).
- **12.4.1.16 Plugs and receptacles.** Plugs and receptacles shall be designed so that a plug of one voltage rating cannot be inserted into a receptacle of another rating.
- **12.4.1.17 "Hot" leads.** Wiring shall be routed through plugs and receptacles so that "hot" leads are not exposed in either the plug or the receptacle when they are disconnected (same as paragraph 6.8.5.1.5).
- **12.4.1.18 Design and location of electrical installations and electrical utilization equipment.** The design and location of electrical installations and electrical utilization equipment shall conform with 29 CFR 1910.302 through 308 which includes rules for workspace clearances around such equipment dependent upon its nominal voltage to ground and nominal voltage between phases for elevated energized parts. These rules apply to the protection of qualified electrical or electronic repair people, unqualified electrical or electronic repair people, and other unqualified personnel who could be exposed to electrical hazards or to electrical equipment in classified hazardous electrical locations. 29 CFR 1910.331 -335 address safety related work practices.

## 12.4.2 Switches

- **12.4.2.1 Main-power switches.** A unit of equipment shall have a clearly labeled main-power switch that turns off all power by opening leads from the main-power service connection.
- **12.4.2.2 Main-power switch location.** Main-power switches shall be located so that accidental contact by maintainers will not place the equipment in operation. A lockout shall be provided as specified in 29 CFR 1910.335 (b)(2).
- **12.4.2.3 Physical protection at main-power switches.** The "hot" side of the main-power switch and the incoming power line connections shall be physically protected against accidental contact by maintainers.
- **12.4.2.4 Arc prevention.** Main-power switches shall be safeguarded to prevent heavy arcing.
- **12.4.2.5 Safety switches.** Safety switches that will deactivate associated mechanical drive components shall be provided for the purpose of disconnecting these components without disconnecting other parts of the equipment.
- **12.4.2.6 Switch box safety.** The switch box should be designed so the box cannot be opened when the switch is turned on.

### 12.4.3 Discharging devices

Circuits that contain capacitors can store lethal charges for relatively long periods of time therefore all medium- and high-voltage power supplies need devices that discharge the capacitors when they are turned off.

- **12.4.3.1 Bleeders.** Bleeders shall be incorporated in all power supplies unless they can discharge 30 volts or less within 2 sec after power removal. When a resistive bleeder network is used to discharge capacitors, the bleeder network shall consist of at least two equal valued resistors in parallel.

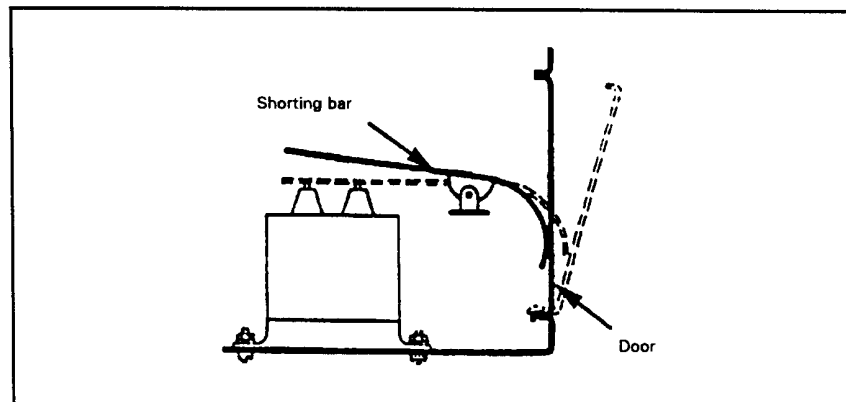
**Discussion.** It is better to discharge capacitors gradually, rather than shorting them. High-power resistors are often used in place of a grounding rod with several thousand ohms of resistance being a typical value. DC power supplies may be discharged when switched off by having a permanently connected bleeder resistor across the output terminals. The bleeder resistor needs to be of low enough resistance so that it is able to discharge the capacitors quickly after the power is turned off but not so low that it overloads the circuit.

- **12.4.3.2 Shorting rods.** Shorting rods shall be provided (in addition to bleeder resistors) with all equipment having voltages in excess of 70 volts ac or dc.

**Discussion.** Some circuits with large, high-voltage capacitors (such as high-voltage radar equipment) cannot use bleeder resistors; other methods need to be used to discharge the capacitors before doing maintenance. Often capacitors are discharged with a shorting or grounding rod that has a well-insulated handle.

- **12.4.3.3 Removing power.** Interlocks shall remove power by mechanical releases or electrical solenoids, before automatic shorting bars (see exhibit 12.4.3.3) discharge the power supply. These bars shall operate automatically whenever the enclosure is opened and function quickly, with high reliability.

**Exhibit 12.4.3.3** Automatic shorting bar

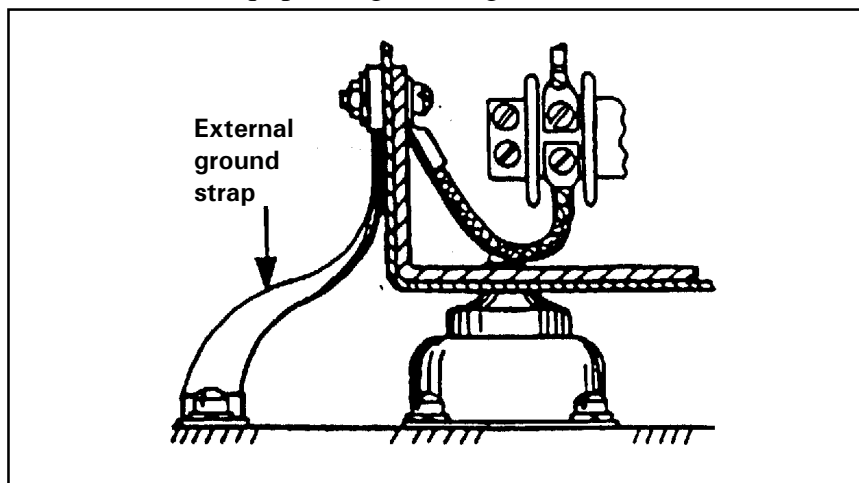


- **12.4.3.4 Shorting rod storage.** Where size permits, shorting rods shall be stored within the transmitting equipment, permanently attached, and readily accessible to maintainers. The permanently attached rod shall be connected through a flexible stranded copper wire (covered with a transparent sleeve) to the stud provided at the transmitter main frame. Where size does not permit internal storage of a shorting rod, a grounding stud shall be provided to permit attachment of a portable shorting rod. The connection to the stud shall be such that accidental loosening or high resistance to the ground is prevented.

## 12.4.4 Grounding

Various grounding techniques are used to protect maintainers from dangerous voltages in equipment. A terminal that is spot-welded to the chassis provides a reliable ground connection. Guidelines for other methods are also given in this section.

- **12.4.4.1 Same common ground.** All enclosures, exposed parts, and the chassis shall be kept at ground potential by a common ground.
- **12.4.4.2 Path to ground.** The path from the ground connection to ground shall:
  - a. be continuous and permanent,
  - b. have ample carrying capacity to conduct safely any currents that may be imposed on it,
  - c. have impedance sufficiently low to limit the voltage above ground and to facilitate the operation of the over-current devices in the circuits, and
  - d. have sufficient strength to minimize the possibility of ground disconnection.
- **12.4.4.3 Grounding techniques.** If welding is not feasible, for example with aluminum chassis, the ground connection of equipment shall be attached with a machine bolt, lock washer, and nut.
- **12.4.4.4 Nonconductive finishes.** Any nonconductive finish on a unit of equipment shall be removed before attaching the ground connection.
- **12.4.4.5 Rivet connections.** Ground connections shall not be attached with rivets because rivets do not give reliable electrical connections.
- **12.4.4.6 Equipment grounding.** The common ground of equipment should connect to a bolt that goes through the enclosure and that is clearly marked "ENCLOSURE GROUND". An external safety ground strap should, in turn, be connected to this bolt. The external safety ground strap should be a plated flexible copper strap with a current-carrying capacity at least twice as large as the equipment requires (see exhibit 12.4.4.6).

**Exhibit 12.4.4.6** Equipment grounding

- **12.4.4.7 Ground connections.** Ground connections to shields, hinges, slides, or other mechanical components shall not be used to complete electrical circuits.
- **12.4.4.8 Hinges and slides.** Hinges and slides shall not be used for grounding paths.
- **12.4.4.9 Panels and doors.** Panels and doors that contain meters, switches, and test points shall be attached or hinged so that they are at the same voltage as the equipment in which they are mounted, whether opened or closed.

**Discussion.** A ground is considered satisfactory if the electrical connection between the door or panel and the ground connection exhibits a resistance of 0.1 ohm or less. A satisfactory ground also has sufficient current-carrying capacity to ensure the reliable and immediate tripping of equipment over-current protection devices.

- **12.4.4.10 Ground wire in the cable.** Any external or interconnecting cable in which a ground is part of the circuit shall include a ground wire in the cable. This ground wire shall be terminated at both ends in the same way as the other conductors.
- **12.4.4.11 Cable shields as grounds.** Cable shields shall not be used as current-carrying ground connections except with coaxial cables.
- **12.4.4.12 Test equipment.** Test equipment (signal generators, amplifiers, and oscilloscopes) that is connected by a plug shall have an integral ground prong.

## 12.4.5 Electrical tools and self-powered equipment

- **12.4.5.1 Insulation of tools.** Tools used near high voltages shall be insulated.
- **12.4.5.2 Electrical cords.** Electrical hand-held power tools shall be designed with three-wire power cords with one wire grounded. Portable tools protected by an approved system of double insulation or its equivalent may be used without a ground wire when approved by the acquisition program office.
- **12.4.5.3 Exposed surfaces of tools.** Electrical hand-held power tools shall have exposed surfaces that are either nonconducting or are electrically connected to the ground wire.

**Discussion.** Exposed surfaces include cases, grips, handles, switches, triggers, chucks, and other surfaces with which maintainers might come into contact with during operation.

- **12.4.5.4 Same voltage.** All external surfaces of self-powered equipment shall be at the same voltage.

## 12.5 Physical hazards

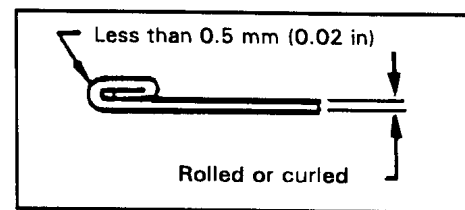
General safety guidelines for physical hazards are given in this section. This section focuses on making equipment free of potential physical hazards to maintainers. Guards, caps, and shields are addressed specifically.

### 12.5.1 General

- **12.5.1.1 Protective devices.** Protective covers, cases, or padding shall be used on protrusions or other objects that cannot be made completely hazard free.
- **12.5.1.2 Carried units.** Components and equipment shall be designed so maintainers can carry them without risk of cutting their hands on sharp edges.
- **12.5.1.3 Countersunk screws.** Screws shall be countersunk if a smooth surface is required.
- **12.5.1.4 Exposed edges.** Exposed edges shall be either protected by rubber, fiber, or plastic or rounded as follows:

- a. The edges of thin sheets less than 0.5 mm (0.02 in) thick shall be rolled or curled as shown in exhibit 12.5.1.4 (a).

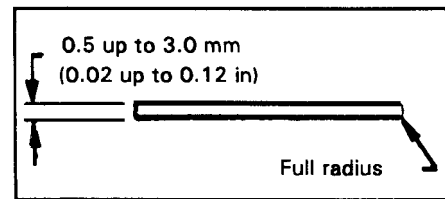
**Exhibit 12.5.1.4 (a)** Rolling edges of sheets less than 0.5 mm (0.02 in) thick





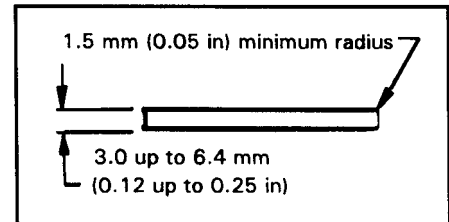
- b. Exposed edges 0.5 to 3.0 mm (0.02 up to 0.12 in) thick shall be rounded to a full radius as shown in exhibit 12.5.1.4 (b).

**Exhibit 12.5.1.4 (b) Rounding exposed edges 0.5 up to 3.0 mm (0.02 up to 0.12 in) thick**



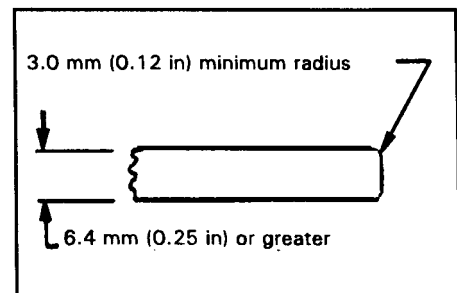
- c. Exposed edges 3.0 up to 6.4 mm (0.12 up to 0.25 in) thick shall be rounded to a minimum radius of 1.5 mm (0.05 in) as shown in exhibit 12.5.1.4 (c).

**Exhibit 12.5.1.4 (c) Rounding exposed edges 3.0 up to 6.4 mm (0.12 up to 0.25 in) thick**



- d. Exposed edges 6.4 mm (0.25 in) thick or greater shall be rounded to a minimum radius of 3.0 mm (0.12 in) as shown in exhibit 12.5.1.4 (d).

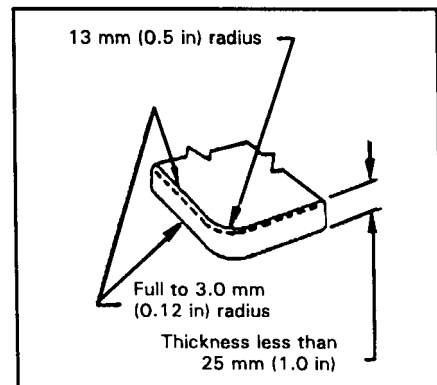
**Exhibit 12.5.1.4 (d) Rounding of exposed edges 6.4 mm (0.25 in) thick or greater**



- **12.5.1.5 Exposed corners.** Exposed corners shall be rounded as follows:

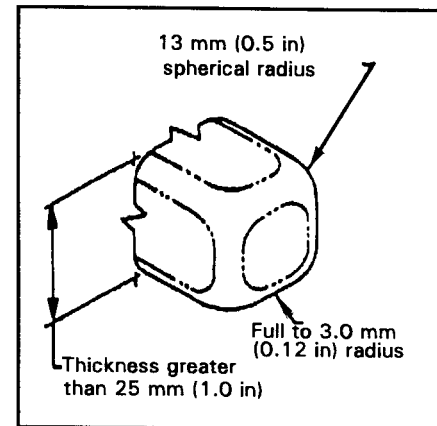
- a. Exposed corners less than 25 mm (1.0 in) thick shall be rounded to a minimum radius of 13 mm (0.5 in) as shown in exhibit 12.5.1.5 (a).

**Exhibit 12.5.1.5 (a) Requirements for rounding of corners less than 25 mm (1.0 in) thick**



- b. Exposed corners 25 mm (1.0 in) thick or greater shall be rounded to 13 mm (0.5 in) spherical radius, as shown in exhibit 12.5.1.5 (b).

**Exhibit 12.5.1.5 (b)** Requirements for rounding of corners greater than 25 mm (1.0 in) thick



- **12.5.1.6 Projecting components.** In areas where maintainers must make rapid movements, small projecting components should be avoided or covered.

**Discussion.** If small projecting parts (such as toggle switches or small knobs) must be mounted on a front panel, recessed mountings of these projecting parts are desirable.

- **12.5.1.7 Latches.** Latches or similar devices that can pinch fingers shall not be used.
- **12.5.1.8 Levers, cranks, hooks, and controls.** Levers, cranks, hooks, and controls shall not be located where they can pinch, snag, or cut the maintainer or his or her clothing.
- **12.5.1.9 Burr free.** Exposed surfaces that can be grasped by the bare hand shall be free of burrs.
- **12.5.1.10 Capped bolt threads.** Bolts with more than two exposed threads shall be capped to protect the maintainer from the sharp threads.
- **12.5.1.11 Air-exhaust openings.** Air-exhaust openings used to cool equipment should be located so that maintainers are not exposed to moving parts or direct drafts.

## 12.5.2 Guards, caps, and shields

- **12.5.2.1 Avoiding accidental contact.** Equipment shall have shields and guards to prevent maintainers from accidentally touching rotating or oscillating parts such as gears, couplings, levers, cams, and large solenoids.
- **12.5.2.2 Enclosure of hazardous components.** Any component that rotates, oscillates, or carries high voltage shall be enclosed so that maintainers cannot accidentally come in contact with the component.

- **12.5.2.3 Ventilation holes.** If a cover or shield requires ventilation holes, the holes shall be small enough to prevent inadvertent insertion of objects that might touch high voltage sources or moving parts (same as paragraph 6.5.1.7).
- **12.5.2.4 High-temperature units of equipment.** High-temperature units of equipment shall be located, guarded, or shielded so that maintainers will not accidentally touch them.
- **12.5.2.5 Guard design.** Guards should be designed and mounted so that maintainers do not have to remove them in order to inspect components. Guard design and applications shall comply, as applicable with provisions of 29 CFR 1910.211 -222 which addresses guarding for various industries.

## 12.6 Liquid and gas hazards

This section gives guidelines for maintaining safety near liquid and gas lines. 29 CFR 1910.101 -111 address handling of hazardous gases and liquids including those that are flammable and combustible. Electrical requirements associated with such hazards are treated.

- **12.6.1 Releasing gases.** Equipment shall not release gases that combine with the atmosphere to form an acid or corrosive alkali that would be detrimental to the health of the maintainer.
- **12.6.2 Distinctive types.** Connectors for lines serving different functions, for example, fuel lines and water lines, or electrical power lines and radio-frequency signal lines, shall be distinctively different and physically incompatible (same as paragraph 6.8.2.1.1).
- **12.6.3 Automatic shutoffs.** Automatic shutoff devices shall be provided on fluid and fuel service equipment to prevent overflow and spillage.
- **12.6.4 Avoid spraying fluids.** Lines shall be kept from spraying or draining fluid on personnel or equipment during disconnection by: (1) locating connections away from work areas and sensitive components, (2) shielding sensitive components where required, and (3) providing drains and bleed fittings so lines can be drained or depressurized before they are disconnected (same as paragraph 6.9.2.1.8).
- **12.6.5 Mercury.** Components and equipment containing mercury shall not be used unless use of mercury is specifically required or approved by the acquisition program office.
- **12.6.6 OSHA safety criteria for hazardous gases and liquids.** Design and handling for hazardous liquids and gases shall be governed by 29 CFR 1910.101 -111.

## 12.7 Toxic hazards

All reasonable precautions need to be taken to eliminate hazards from toxic fumes, for example, those from the exhausts of internal combustion engines. From the standpoint of health hazards, the most widespread toxic hazards are carbon monoxide

from gasoline engines, and aldehydes and nitrogen oxides from diesel engines. This section gives guidelines for keeping toxic hazards within safe limits in the maintainer's environment. 29 CFR 1910 addresses toxic chemical hazards and their control. 29 CFR 1910.1450 addresses controls and exposures in laboratories. Exposures to cleaning materials is addressed in 29 CFR 1910.107 and 252. Specific chemical agents, air contaminants and fibers, and processing operations are covered in 29 CFR 1910.

- **12.7.1 Exposure.** Maintainers shall not be exposed to concentrations of toxic substances in excess of the limits specified in either 29 CFR 1910 or the American Conference of Governmental Industrial Hygienists Threshold Limit Values. If a discrepancy exists between these documents, 29 CFR 1910 shall take precedence.
- **12.7.2 Carbon monoxide.** Maintainers shall not be exposed to concentrations of carbon monoxide (CO) in excess of 50 parts per million (ppm) or 55 mg/m<sup>3</sup>.

**Discussion.** Carbon monoxide is particularly dangerous in that it is odorless, colorless, and tasteless. Its effects are cumulative; doses that may be tolerable by individuals over brief periods may prove to be dangerous to them when repeated or prolonged over several hours.

Carbon monoxide combines with the blood to form carboxyhemoglobin (COHb). CO accumulates rapidly in the blood, however, the body is extremely slow in reducing the COHb level which may account for its toxic action. Maximum COHb levels have been set at 5% for all system design objectives and aviation system performance limits and at 10% for all other system performance.

- **12.7.3 Cadmium oxide fumes.** Maintainers shall not be exposed to more than 0.1 milligrams of cadmium oxide per cubic meter of air. If possible, adequate ventilation shall be provided whenever any silver solder is used. If adequate ventilation cannot be supplied, maintainers shall be provided with respirators to prevent serious exposure to the cadmium oxide fumes.

**Discussion.** When a cadmium alloy containing a silver brazing is heated appreciably above its melting point, acutely poisonous brown or yellow cadmium oxide fumes are released. Inhalation of cadmium oxide fumes can result in serious and sometimes fatal damage to maintainers.

- **12.7.4 Fumes from batteries.** Adequate ventilation shall be provided in all battery service facilities. Fumes from batteries can be harmful to maintainers both because of the hazards of breathing the fumes themselves and because the fumes may displace oxygen.

- **12.7.5 Safety for toxic chemicals and materials.** Safety design and operation for toxic materials shall be governed by 29 CFR 1910.1200 and its appendix A.
- **12.7.6 Asbestos.** Components and equipment containing asbestos shall not be used.

## 12.8 Radiation hazards

Radiation emitting systems and equipment require special consideration to minimize hazards to maintainers. Potential hazards arising from nuclear and electromagnetic radiation need to be evaluated by specialized personnel trained in investigating and controlling such hazards. 29 CFR 1910.96 and .97 address the effects of ionizing and non-ionizing radiation respectively. This section includes the guidelines for radiation hazards.

- **12.8.1 Radioactive materials.** Use of radioactive materials shall conform to Nuclear Regulatory Commission regulations and shall require approval of the acquisition program office.
- **12.8.2 Radium.** Radium shall not be used for luminosity (for example, making components visible in the dark).
- **12.8.3 Ionizing radiation exposure.** The radiation measured at any external surface of a unit of equipment producing ionizing radiation shall not exceed 0.5 milliroentgens per hour (rem) at a distance of 50 mm (2 in). Cumulative whole body exposure to maintainers shall not exceed 3 rem for any calendar quarter and 5 rem for any calendar year. The cumulative occupational exposure to an employee shall not exceed 5(n-18) rems where n equals the individual's age at the last birthday. Employees under 18 years of age shall not be exposed to over 10 percent of the allowable calendar quarter dose. OSHA 29 CFR 1910.96 and 97 shall govern protection from and exposure to ionizing and non-ionizing radiation respectively.
- **12.8.4 Microwave and radio frequency radiation.** Electronic equipment or electrical equipment capable of emitting microwave or radio frequency radiation between 300 KHz and 100 GHz shall be designed, fabricated, shielded, and operated to avoid overexposure of maintainers. According to 29 CFR 1910.97, partial or whole body electromagnetic radiation between 10 MHz and 100GHz shall be restricted a maximum of 10mW/cm<sup>2</sup> over any 0.1-hour period. Equipment design and installation in any unrestricted area accessible to maintainers shall meet the requirements of IEEE C95.1.

## 12.9 Protection from special chemicals

Protection from special chemicals (such as battery electrolyte) cleaning solvents, Polychlorinated Byphenyls, and carcinogens is addressed in this section.

- **12.9.1 Eye protection.** Maintainers shall be provided eye protective devices to use when they measure storage battery specific gravity or when they handle electrolyte. These protective devices shall offer side as well as frontal protection. According to 29 CFR 1926.441 (especially (a)(5) and (a)(6)) face

shields, aprons, and rubber gloves shall be worn as protection for battery workers. 12.9.3 according to 29 CFR 1926.441. Quick drenching facilities shall be provided within 25 feet of the battery handling area.

- **12.9.2 Gloves and aprons.** Maintainers shall be provided acid resistant gloves and aprons for protection against the splattering of battery acid.
- **12.9.3 Large-sized service facilities.** If large quantities of electrolyte are handled or a large number of batteries are maintained, facilities shall be provided for quick drenching or flushing of the eyes and body.

**Exception.** If the storage batteries are of the enclosed type and the facility is equipped with explosion proof or resistant vents, sealed water rinse or neutralizing packs may be used.

- **12.9.4 Small-sized service facilities.** If small quantities of electrolyte are handled and a small number of batteries are maintained, water rinse for flushing of the eyes and body shall be provided in place of drenching or flushing facilities.
- **12.9.5 Cleaning solvents.** Adequate ventilation shall be provided whenever any solvents or cleaners are used. Solvents that produce fumes (such as carbon tetrachloride) shall not be used and all permissible cleaning solvents shall be stored in safety cans.

**Discussion.** Inhaled fumes from carbon tetrachloride are extremely hazardous to the respiratory system and some may have a caustic effect on the skin.

- **12.9.6 Polychlorinated Biphenyls (PCBs).** Maintainers shall be provided protective clothing when handling PCBs. All PCB items (such as transformers, capacitors, hydraulic machinery, and circuit breakers) with PCB concentrations of 500 parts per million shall be marked, inspected, and disposed of according to FAA Order 1050.14. PCBs shall not be used when suitable substitutes are available.
- **12.9.7 Carcinogens.** The use of chemicals that have been identified by the Occupational Safety and Health Act (OSHA) as cancer producing substances (carcinogens) shall be evaluated and conform to 29 CFR 1910.

## 12.10 Temperature hazards

Tissue burns can occur when skin temperature reaches 45°C (113°F). Objects at temperatures in excess of this can be touched safely, depending on the: (1) duration of touch, (2) finish and diffusivity of the surfaced touched, (3) force of contact, and (4) size of contact area. Guidelines for equipment related temperature are given in this section.

- **12.10.1 "Touch temperature" contact.** Equipment that in normal operation exposes maintainers to surface temperatures

outside the range of temperatures shown in exhibit 12.10.1, shall be shielded. Cryogenic systems shall also be shielded.

**Exhibit 12.10.1** Upper and lower temperature limit range

Exposure	Temperature limits		
	°C (°F)		
	Metal	Glass	Plastic or wood
Momentary contact	0-60 (32-140)	0-68 (32-154)	0-85 (32-185)
Prolonged contact or handling	0-49 (32-120)	0-59 (32-138)	0-69 (32-156)

- **12.10.2 Perforation size.** Cases, covers, and shields that are perforated to permit ventilation shall be no larger than 13 mm (.050 in) in diameter to prevent inadvertent insertion of objects that might touch high voltage sources or moving parts. Many smaller perforations are preferable to a few large ones.

## 12.11 Fire Protection

The avoidance and minimization of fire hazards begins with good housekeeping, which needs to be a personal goal of all maintainers. This section gives guidelines for reducing fire hazards. Fire protection provisions which affect design of facilities and equipment as well as operations and maintenance are governed by OSHA 29 CFR 1910 Subpart Fire Protection L (155 -167) Subpart H Hazardous materials (101 -119) and Associated national consensus standard sponsored by the National Fire Protection Association and the American National Standard Institute. 29 CFR 1910.307 and 308 address electrical installations in hazardous locations and environments.

- **12.11.1 Nonflammable enclosures.** If capacitors, inductors, and motors are potential fire hazards, they shall have nonflammable enclosures with a minimum of number of openings.
- **12.11.2 Flammable materials.** If possible, designers should avoid specifying the use of flammable materials in equipment.
- **12.11.3 Flammable gases.** If possible, equipment shall be designed so that it will not emit flammable gases during storage or operation. If this is not possible, automatic cutoffs and suitable warnings shall be provided. 29 CFR 1910.101 -119 governs handling of hazardous materials including those that are flammable, combustible, and explosive.
- **12.11.4 Fire extinguishers.** Where fire hazards exist, portable, hand-operated fire extinguishers shall be located where fires will not block their access.
- **12.11.5 Selection of fire extinguishers.** Fire extinguishers shall be selected for suitability by the class of fires most likely to

occur in an area. 29 CFR 1910.157 governs the selection and use of fire extinguishers.

**Discussion.** Class A fires involve ordinary flammable materials such as wood, paper, and rags that can be extinguished with water or aqueous solutions. Class B fires involve flammable liquids such as gasoline, solvents, and greases that can be extinguished by dilution, elimination of air, or blanketing. Class C fires involve electrical equipment such as motors, transformers, and switches that need to be extinguished by a substance that does not conduct electricity.

- **12.11.6 Fire protection criteria.** 29 CFR 1910 Subpart L Fire protection (155 -165); Subpart H Hazardous materials (101 -119) and associated national consensus standards sponsored by the National Fire Protection Association and the American National Standards Institute shall govern the fire protection aspects for maintenance of facilities and equipment. 29 CFR 1910.307 -308 governs electrical installations in hazardous locations and environments (see paragraphs 6.1.2.6 and 6.3.5.1.2).

## 12.12 Noise hazards

Noise can be hazardous to maintainers in two general ways: it can cause hearing loss, both temporary and permanent, and it can prevent maintainers from hearing audible warning signals. Guidelines are given in this section to protect maintainers from these hazards. Guidelines concerning administrative and engineering controls to reduce noise and a hearing conservation program are given in section 13.5.

- **12.12.1 General noise levels.** Workplace noise shall be maintained at levels that will not (1) interfere with necessary voice, telephone, and radio communication, (2) cause fatigue or injury, or (3) degrade overall system effectiveness (same as paragraph 13.5.2.3).
- **12.12.2 Noise criteria.** Noise criteria are defined by either the A-weighted sound level, dB(A), or the speech interference level (SIL). The A-weighted sound level is the desired requirement. Where it is not possible to meet the specified A-weighted sound level, the corresponding SIL requirement shall be met (same as paragraph 13.5.2.4).

**Definitions. Preferred speech interference level (PSIL-4)** is a measure of the effectiveness of noise in masking speech. **Speech interference level (SIL or SIL-4)** is the arithmetic mean, in dB (or 20 $\mu$ Pa), of sound pressure levels in the four octave bands with center frequencies of 500, 1000, 2000, and 4000 Hz. **A-weighted sound level (dB(A))** is a sound pressure level (in decibels) measured using a sound level meter with an A-weighting network. The A-weighted response is maximum at 2500 Hz, drops rapidly as frequency decreases below 1000 Hz, and gradually decreases above 4000 Hz, thereby approximating the frequency dependent human response



to moderate sound levels. ANSI S1.4 gives the definition of A-weighting filter characteristics.

- **12.12.3 Extreme quiet areas.** Ambient noise in areas requiring extreme quiet shall not exceed 35 dB(A) or 27 dB PSIL-4 (same as paragraph 13.5.2.5).
- **12.12.4 Small office spaces and special areas.** Ambient noise in areas requiring no difficulty with speech communication (for example, libraries and classrooms) shall not exceed 45 dB(A) or 37 dB PSIL-4; conference rooms and offices shall not exceed 38 dB PSIL-4 (same as paragraph 13.5.2.6).
- **12.12.5 Operational areas.** Ambient noise in areas requiring frequent phone use or requiring occasional speech communication (for example, operations centers, control rooms, tower cabs, and dynamic simulation rooms) at distances up to 4.6 m (15 ft) shall not exceed 55 dB(A) or 47 dB PSIL-4; shop offices and laboratories shall not exceed 48 dB PSIL-4 (same as paragraph 13.5.2.7).
- **12.12.6 Equipment areas.** Ambient noise in areas requiring frequent telephone use or frequent speech communication (for example, computer rooms, engineering areas, equipment rooms, and telephone switching centers) at distances up to 1.5 m (5 ft) shall not exceed 65 dB(A) or 57 dB PSIL-4 (same as paragraph 13.5.2.8).
- **12.12.7 High noise, remote areas.** High noise, remote areas that are normally unmanned shall not exceed 85 dB(A) (same as paragraph 13.5.2.9).
- **12.12.8 Occupational noise exposure and control.** Administrative or engineering controls shall be used to reduce the sound levels to within permissible noise exposure levels listed in exhibit 12.12.7. 29 CFR 1910.95 shall be used in determining equivalent A-weighted sound levels for daily exposure. A hearing conservation program shall be administered any time an employee's noise exposure equals or exceeds an 8-hour time weighted average of 85 db measure on the A scale (slow response) or equivalent without regard to attenuation that may be provided by personal protective equipment. 29 CFR 1910.95 shall govern the hearing protection program (same as paragraph 13.5.2.10).

**Exhibit 12.12.8** Permissible noise exposure

Maximum hours per day	Sound level dBA (slow response) equivalent A-weighted sound level
8.0	90
6.0	92
4.0	95
3.0	97
2.0	100
1.5	102
1.0	105
0.5	110
0.25	115
Maximum impulse noise	140 (peak sound pressure level)

If daily exposure involves two or more periods at differing levels, the combined effect is used.  $C_j/T_j$  is the total time of exposure at a specified level over the time of permissible exposure for that typical level,  $j$ . When the sum,  $\sum(C_j/T_j)$  of the fractions,  $C_1/T_1 + C_2/T_2 + \dots + C_j/T_j + \dots + C_n/T_n$  is greater than one, the combined exposure exceeds the permissible noise limit value.

## 12.13 Explosion and implosion hazards

Maintainers are sometimes exposed to risks of explosion (for example, the presence of explosive gases), or of implosion (for example, a scratched cathode ray tube (CRT)). Guidelines are given in this section to protect the maintainer from such hazards.

- **12.13.1 CRT conformance.** CRTs shall conform to the requirements of UL 1418.
- **12.13.2 Terminal end of CRT.** Whenever possible, the terminal end of CRTs shall be located within the equipment housing. If the terminal end extends outside the equipment housing, it shall have a cover strong enough to protect the tube. This cover shall be anchored to the main housing structure firmly enough to withstand shipping and rough handling so that external pressures will not be transmitted to the tube and its wiring. There shall also be a warning inside the equipment informing maintainers that the neck of the tube is fragile and must be handled with caution.
- **12.13.3 Explosion.** Equipment that may be operated, maintained, or stored in an explosive atmosphere shall be designed to eliminate the possibility of an explosion.

- **12.13.4 Minimizing risk of explosion.** Risk of explosion shall be minimized by isolating hazardous substances from heat sources and by using spark arrestors, vents, drains, or other safety techniques.
- **12.13.5 Explosion causing gases.** Materials shall not liberate gases that will produce an explosive atmosphere.

## 12.14 Radiant energy hazards

This section gives guidelines for radiant energy (200 nm to 1 m) hazards. This range covers ultraviolet through microwave radiant energy.

### 12.14.1 Ultraviolet radiant energy (200-315 nm)

- **12.14.1.1 Exposure limit.** The maximum daily radiant energy exposure to ultraviolet light (200-315 nm) shall not exceed an effective value of  $0.003 \text{ J/cm}^2$ .

**Discussion.** The equations and tables shown in exhibit 12.14.1.1 can be used to convert irradiance measured in each part of the spectrum to total effective irradiance.

**Definition. Irradiance** is the radiant flux density on a given surface.

### 12.14.2 Near-ultraviolet radiant energy (315-400 nm)

- **12.14.2.1 Exposure duration greater than 1000 seconds.** The maximum radiant energy exposure to near ultraviolet light (315-400 nm) shall not exceed  $0.001 \text{ W/cm}^2$  for exposure durations longer than 1000 sec.
- **12.14.2.2 Exposure duration less than 1000 seconds.** The maximum radiant energy exposure limit to near ultraviolet light (315-400 nm) shall not exceed  $1 \text{ J/cm}^2$  in any 1000-second period.

### 12.14.3 Visible and near-infrared radiant energy (400-1400 nm)

Visible and near-infrared radiant energy, with a wavelength of 400 to approximately 1400 nm, is largely transmitted by the ocular media of the eye and absorbed at the retina. Unlike corneal injury from ultraviolet energy, injury to the retina is generally permanent. As a result, special care must be taken to avoid retinal damage.

If appropriate image spectral radiance data are not immediately available, it may be helpful to estimate whether a particular image luminance exceeds permissible exposure limits. The relationship between luminance and radiance has been published for typical lamps, but these values cannot be used directly because radiant energy with a wavelength greater than 700 nm is less effective in heating the retina.

**Exhibit 12.14.1.1** Exposure limit for ultraviolet radiant energy (200 to 315 nm)

$E_{eff} = \sum E_{\lambda} S_{\lambda} \Delta_{\lambda}$ , where:

$E_{eff}$  = Effective irradiance in the 200 nm to 315 nm

$E_{\lambda}$  = Measured spectral irradiance in mW/cm<sup>2</sup> nm

$S_{\lambda}$  = Relative spectral effectiveness (dimensionless) (see below)

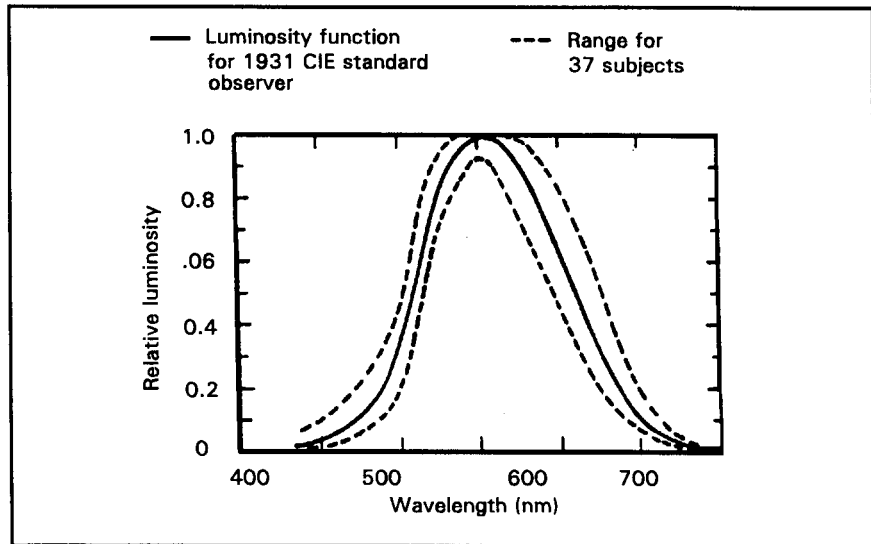
$\Delta_{\lambda}$  = Bandwidth in nanometers (nm)

Wavelength (nm)	Relative spectral effectiveness ( $S_{\lambda}$ )	Daily exposure limit (mJ/cm <sup>2</sup> )	Effective irradiance $E_{eff}$ (mW/cm <sup>2</sup> )	Maximum exposure per day*
200	0.03	100	0.0001	8 hr
210	0.0075	40	0.0002	4 hr
220	0.12	25	0.0004	2 hr
230	0.19	16	0.0008	1 hr
240	0.3	10	0.0017	30 min
250	0.43	7	0.0033	15 min
254	0.5	6	0.005	10 min
260	0.65	4.6	0.01	5 min
270	1.0	3.0	0.05	1 min
280	0.88	3.4	0.10	30 sec
290	0.64	4.7	0.30	10 sec
300	0.30	10.0	3.00	1 sec
305	0.06	50.0	6.00	0.5 sec
310	0.015	200	30.00	0.1 sec
315	0.003	1000		

\* These values assume that no other occupational exposure occurs

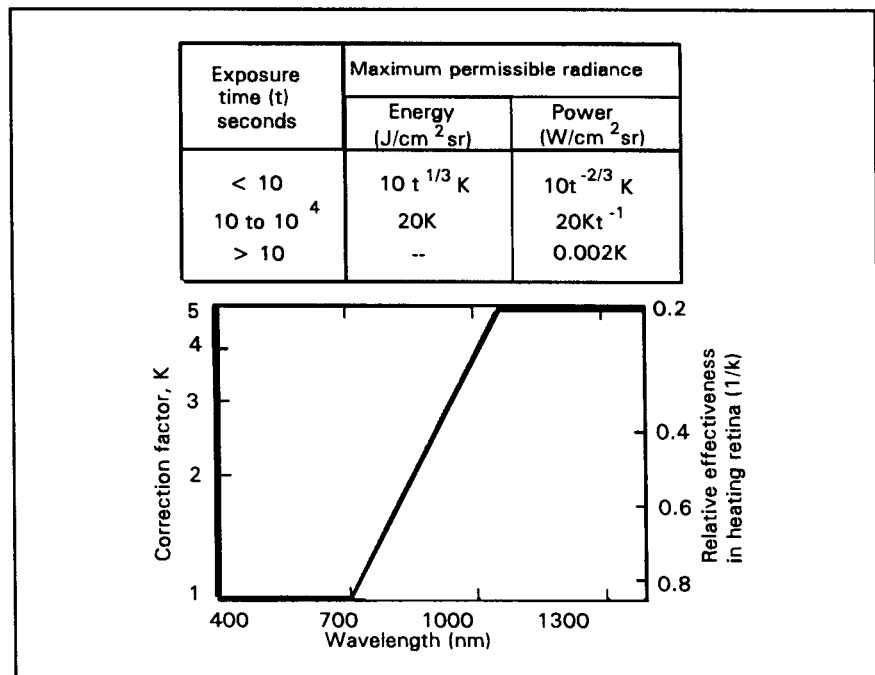
If the spectral distribution of radiant energy in the displayed image is known, the luminosity function for the eye (see exhibit 12.14.3) can be used to calculate the ratio between luminance and effective radiance, and hence, the permissible luminance. This process is illustrated here for three hypothetical equal-energy-per-wavelength sources that differ in wavelength range.

**Exhibit 12.14.3** Relative contribution of different wavelengths to luminance--the luminosity function



- 12.14.3.1 Exposure of the eye.** The maximum radiant energy exposure to visible and near-infrared light (400-1400 nm) shall not exceed the limits given in exhibit 12.14.3.1. These limits apply to any source larger than 1°.

**Exhibit 12.14.3.1** Maximum safe exposure to 400-1400 nm radiant energy



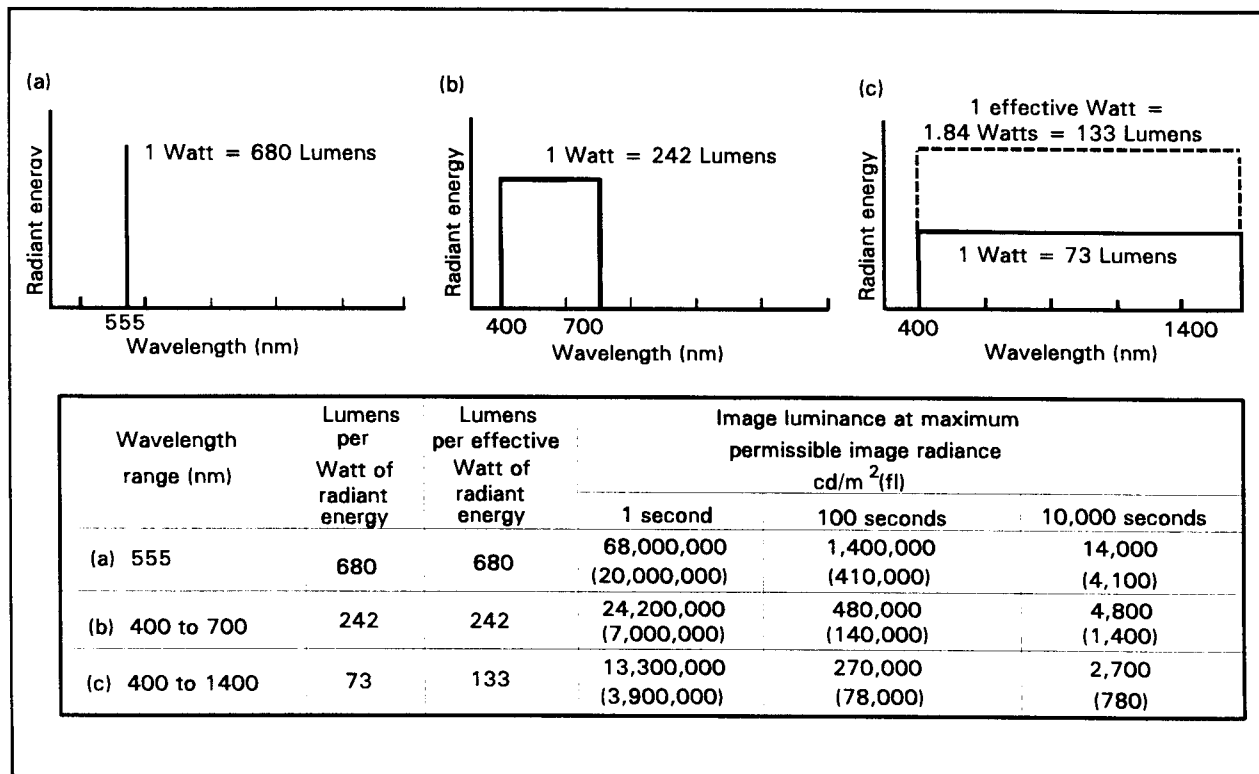
**Note.** For wavelengths longer than 700 nm, a correction factor, K, is required to compensate for the increase in

absorption in the ocular media and the decrease in absorption by the retina.

- **12.14.3.2 Exposure of skin.** The maximum radiant energy exposure of a maintainer's skin to visible and near-infrared light (400-1400 nm) shall not exceed 0.2 W/cm<sup>2</sup>.
- **12.14.3.3 Removing infrared.** If infrared radiant energy exceeds the allowable limit, filters shall be provided to protect the maintainer's eyes from unnecessary heat.
- **12.14.3.4 Maximum display.** High-luminance displays should not exceed 242 lumens per effective watt of the 400 to 700 nm source (see exhibit 12.14.3.4).

**Definition.** An effective watt is equal to 1.84 watts.

**Exhibit 12.14.3.4** Estimation of permissible image luminance



**12.14.4 Far-infrared radiant energy (1400-10<sup>6</sup> nm)**

- **12.14.4.1 Short term exposure.** The maximum radiant energy exposure to far-infrared light (1400-10<sup>6</sup> nm) for 60-120 seconds shall not exceed 0.1 W/cm<sup>2</sup>. A measurement aperture of 1 mm (0.04 in) shall be used for wavelengths shorter than 10<sup>5</sup> nm, and an aperture of 11 mm (0.43 in) shall be used for longer wavelengths.

- **12.14.4.2 Chronic exposure.** The maximum chronic radiant energy exposure to far-infrared light (1400-10<sup>6</sup> nm) shall not exceed 0.01 W/cm<sup>2</sup>. A measurement aperture of 1 mm (0.04 in) shall be used for wavelengths shorter than 10<sup>5</sup> nm, and an aperture of 11 mm (0.43 in) shall be used for longer wavelengths.

### 12.14.5 Microwave radiant energy (10<sup>7</sup>-10<sup>11</sup> Hz)

- **12.14.5.1 Exposure limit.** The maximum radiant energy exposure to microwave radiation (10<sup>7</sup>-10<sup>11</sup> Hz, which corresponds to wavelengths of 1 mm (0.04 in) to 1 m (39.37 in)) is 0.01 W/cm<sup>2</sup> averaged over a 0.1-hour period.

## 12.15 Laser hazards

This section gives guidelines for protecting the maintainer from laser hazards.

- **12.15.1 Laser radiation.** Laser equipment and system design, installation, and operational and maintenance procedures shall conform to 21 CFR 1040.
- **12.15.2 Laser exposure limits.** In accordance with 29 CFR 1926.54 (j), employees shall not be exposed to laser light intensities above:
  - a. Direct staring: 1 microwatt per square centimeter.
  - b. Incidental observing: 1 milliwatt per square centimeter.
  - c. Diffuse reflected light: 2 1/2 watts per square centimeter.

Discussion. For safety reasons, laser units need to be set up to operate above head level of employees, when possible.

- **12.15.3 Eye protection from laser light.** 29 CFR 1926.54 shall govern potential exposure areas to direct or reflected laser light. Employees shall be provided with antilaser eye protection devices if any such exposure to laser light greater than 5 milliwatts exists. 29 CFR 1926.102 (b)(2) shall govern optical density of the eye protection based upon the maximum power density and specific wavelength of the laser.
- **12.15.4 Labeling of laser protective goggles.** 29 CFR 1926.102 (b)(2)(ii) shall govern the labeling laser optical protection devices. Labels shall include the following:
  - a. Laser wavelengths for intended use.
  - b. Optical density of those wavelengths.
  - c. The visible light transmission.

- **12.15.5 Qualified laser equipment operators.** Only trained and qualified laser equipment operators shall install, adjust, or operate laser equipment. Proof of qualification must be in possession of these employees during any laser operation.
- **12.15.6 Laser alignment.** In accordance with 29 CFR 1926.54 (f) only mechanical or electronic means shall be used as a detector for guiding the internal alignment of a laser.
- **12.15.7 Personnel laser safety.** A laser beam shall not be directed at personnel. Personnel shall be prohibited in the area of the laser source, beam, and target. When practical, laser system operation shall be prohibited in rain, snow, dust, or fog. Laser beam shall be either turned OFF, capped, beam shutdown when not actually required. It shall be turned OFF if unattended.

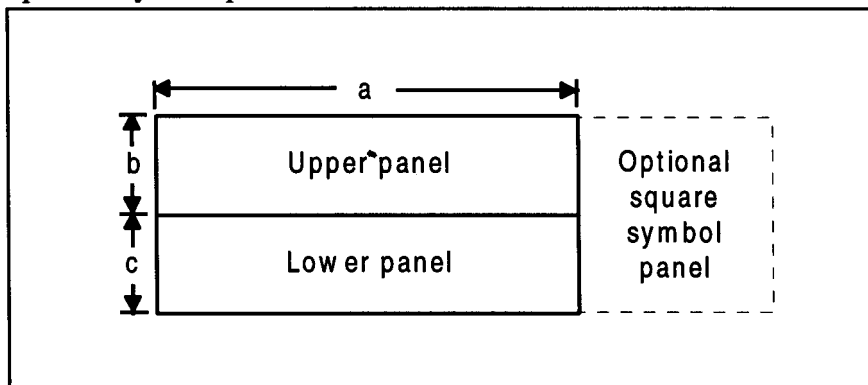
## 12.16 Safety labels and placards

This section contains guidelines for the labeling and placing of placards on hazardous components, equipment, and systems. Use of these guidelines will help to ensure the safety of maintainers and equipment.

- **12.16.1 Warning labels and placards.** Labels or placards shall be placed on or adjacent to any equipment that presents a hazard (for example, high voltage, heat, toxic vapors, explosion, and radiation) to maintainers. These labels or placards shall describe the hazard and state precautions the maintainer can take.
- **12.16.2 Label and placard design.** Labels and placards shall consist of three panels as shown in exhibit 12.16.2. The ratio of width to height of the upper panel (a:b) shall fall within the range of 2:1 to 5:1 inclusive. The lower panel width shall be equal to the upper panel width (both equal to a). The lower panel height shall be equal to or greater than the upper panel height, but less than twice the width of the sign ( $b \leq c < 2a$ ). The optional symbol panel shall be square with its edge equal to the sum of the upper and lower panel ( $b + c$ ) and placed to the right of the upper and lower panels. The upper panel shall contain the signal or key work. the lower panel shall contain additional direction or explanation. Wording of this panel shall be brief, provide positive direction (if possible), and be limited to a single hazard.
- **12.16.3 Label and placard design classifications and specifics.** Signs shall have one of four classifications:
  - a. Class I (Danger). Danger labels and placards indicate immediate and grave danger or peril, a hazard capable of producing irreversible damage or injury, and prohibitions against harmful activities. These signs shall have the word "DANGER" in white within a red oval outline with a white on black rectangle in the upper panel. The lower panel, for additional wording, shall be in black or red on a white background.



**Exhibit 12.16.2** Label and placard layout--two panel sign with optional symbol panel



- b. Class II (Caution). Caution labels and placards are used to call attention to potential danger or hazard, or a hazard capable of, or resulting in severe but not irreversible injury or damage. These signs shall have the signal word "CAUTION" in yellow on a black rectangle in the upper panel. The lower panel, for additional wording, shall be in black on a yellow background.
  - c. Class III (General safety). General safety labels and placards include notice of general practice and rules relating to health, first aid, housekeeping, and general safety other than the two cases above. These signs shall have the appropriate key word in white on a green rectangle in the upper panel. The lower panel, for additional wording, shall be in black or green on a white background.
  - d. Class IV (Fire and emergency). Fire and emergency labels and placards shall be used only to label or point the way to fire extinguishing equipment, shutoffs, emergency switches, and emergency procedures. These signs shall have the key word in white on a red rectangle in the upper panel. The lower panel, for additional wording, shall be in red on a white background.
- **12.16.4 Label and placard placement.** Labels and placards shall be placed so as to alert and inform in sufficient time to avoid the hazard or to take appropriate action. They shall be: (1) readable from a distance, (2) create no additional distractions, or (3) be hazardous themselves.
  - **12.16.5 Illumination for warning labels and placards.** Warning labels and placards shall be visible under the conditions in which the maintainer needs to see them. Special illumination may be needed to meet this criterion.
  - **12.16.6 Wording for medium voltage labels and placards.** If a voltage between 70 and 500 volts is present, a caution label or

placard shall be provided that includes the following statement or its equivalent: "CAUTION (insert maximum voltage) VOLTS." The label or placard shall be in accordance with ANSI Z535.2.

- **12.16.7 Wording for high voltage labels and placards.** If a voltage in excess of 500 volts is present, a warning label or placard shall be provided that includes the following statement or its equivalent: "DANGER -- HIGH VOLTAGE (insert maximum voltage) VOLTS." The label or placard shall be in accordance with ANSI Z535.2.
- **12.16.8 Microwave or rf radiation warning labels and placards.** Each unit of equipment that can emit microwave or rf radiation levels between 300 KHz and 100 GHz shall have a warning label or placard. This warning label or placard shall be in accordance with ANSI Z535.2 and ANSI C95.2. Labels shall be provided on all radiation shields and covers to warn maintainers of the radiation hazards involved upon removal.
- **12.16.9 X radiation shield labels or placards.** Shields that protect maintainers from X radiation shall have labels or placards in accordance with 10 CFR 20.
- **12.16.10 Ionizing radiation symbols.** Ionizing radiation hazard symbols shall be in accordance with ANSI N2.1.
- **12.16.11 Laser warning labels and placards.** Laser warning labels and placards shall be in accordance with 21 CFR 1040 unless a unit of equipment has been certified as exempt. In accordance with 29 CFR 1926.54 (d) all areas on which lasers are used shall be posted with standard laser warning placards.

**Discussion.** If a piece of equipment is exempt, the unit of equipment shall have a label or placard that states: CAUTION--This electronic product has been exempted from FDA radiation safety performance standards, as prescribed in the Code of Federal Regulations, Title 21, Chapter I, Subchapter J, pursuant to Exemption No. 76 EL-01 DOD issued on 26 July 1976. This product should not be used without adequate protective devices or procedures.

- **12.16.12 Line identification.** Liquid and gas lines shall be clearly and unambiguously labeled or coded as to contents, pressure, heat, cold, or other hazardous properties in accordance with MIL-STD-1247.
- **12.16.13 Electrical labels and placards.** If appropriate, all receptacles shall be marked with their voltage, phase, and frequency characteristics.
- **12.16.14 Center of gravity.** If the unit has a high center of gravity or if the weight of a unit of equipment is not evenly distributed, the center of gravity shall be clearly marked.

- **12.16.15 Weight labels.** Weight and center of gravity caution placards shall be placed on any unit of equipment to be moved for maintenance if its weight exceeds 13.6 kg (30 lbs.). If it is designed to be lifted or carried by more than one person, the label shall include the number of people recommended to lift or carry it (same as paragraph 6.3.5.1.3).
- **12.16.16 Weight lifting capacity.** Weight lifting capacity shall be indicated on stands, hoists, lifts, jacks, and similar weight-bearing equipment, to prevent possible overloading.
- **12.16.17 Identifying hazardous areas.** Workplaces that require special protective clothing or personal equipment (for example, where steel-toed shoes, gloves, or hard hats are necessary) shall have conspicuous and unambiguous labels or placards.
- **12.16.18 Identifying hand grasp areas.** Hand grasp areas shall be identified by conspicuous and unambiguous labels or placards on the equipment.
- **12.16.19 "NO-STEP" labels or placards.** If appropriate, "NO-STEP" labels or placards shall be provided to prevent injury to maintainers.

## Section 13 contents

<b>13 Environment</b> .....	<b>13-1</b>
<b>13.1 General guidelines</b> .....	<b>13-1</b>
▪ 13.1.1 General environmental extremes .....	13-1
□ 13.1.2 Deviations from tolerable conditions .....	13-1
<b>13.2 Ventilation</b> .....	<b>13-2</b>
▪ 13.2.1 General ventilating systems and temperature differentials .....	13-2
▪ 13.2.2 Small enclosure ventilation .....	13-2
▪ 13.2.3 Large enclosure ventilation .....	13-2
<b>Exhibit 13.2.3</b> Large enclosure ventilation .....	13-2
▪ 13.2.4 Verification of ventilation .....	13-3
▪ 13.2.5 Protective measures .....	13-3
▪ 13.2.6 Intakes .....	13-3
▪ 13.2.7 Control of toxic substances .....	13-3
▪ 13.2.8 Monitoring of measurement procedures .....	13-3
<b>13.3 Temperature and humidity</b> .....	<b>13-3</b>
<b>Exhibit 13.3</b> Comfort zone chart .....	13-4
□ 13.3.1 Thermal tolerance and comfort zones .....	13-5
<b>Exhibit 13.3.1</b> Deriving effective temperature .....	13-5
▪ 13.3.2 Hot air discharge .....	13-6
▪ 13.3.3 Cold air discharge .....	13-6
▪ 13.3.4 Minimum effective temperature .....	13-6
▪ 13.3.5 Maximum effective temperature .....	13-6
□ 13.3.6 ET ranges as a function of work activity .....	13-6
□ 13.3.7 Arctic clothing .....	13-6
□ 13.3.8 Temperature of enclosed workplaces .....	13-6
□ 13.3.9 Side wall temperatures .....	13-7
□ 13.3.10 Minimum relative humidity .....	13-7
□ 13.3.11 Relative humidity .....	13-7
▪ 13.3.12 Verification of humidity .....	13-7
□ 13.3.13 Humidity measurements .....	13-7

<b>13.4 Illumination</b>	.....	<b>13-7</b>
<b>13.4.1 General</b>	.....	<b>13-8</b>
▪ 13.4.1.1 General and supplementary lighting	.....	13-8
▪ 13.4.1.2 Dimming capability	.....	13-8
□ 13.4.1.3 Illumination in workplaces	.....	13-8
<b>13.4.2 Illumination for the workplace and specific tasks</b>	.....	<b>13-8</b>
▪ 13.4.2.1 Lighting level	.....	13-8
▪ 13.4.2.2 Illumination	.....	13-8
<b>Exhibit 13.4.2.2 Specific task illumination requirements</b>	.....	13-9
▪ 13.4.2.3 Glare	.....	13-8
<b>13.4.3 Illumination levels to maintain dark adaptation</b>	.....	<b>13-10</b>
▪ 13.4.3.1 Maximum dark adaptation	.....	13-10
▪ 13.4.3.2 Dark adaptation for task performance	.....	13-10
□ 13.4.3.3 Ambient light and dark adaptation	.....	13-11
<b>13.4.4 Glare from light sources</b>	.....	<b>13-11</b>
▪ 13.4.4.1 Glare from artificial light sources	.....	13-11
<b>13.4.5 Reflected glare</b>	.....	<b>13-12</b>
▪ 13.4.5.1 Specular reflectance from the task area and the surrounding area	.....	13-12
▪ 13.4.5.2 Work surface reflection	.....	13-12
▪ 13.4.5.3 Angle of incidence	.....	13-12
▪ 13.4.5.4 Polished surfaces	.....	13-12
▪ 13.4.5.5 Light source behind maintainer	.....	13-12
<b>13.4.6 Brightness ratio</b>	.....	<b>13-12</b>
▪ 13.4.6.1 Wall surface luminance	.....	13-12
▪ 13.4.6.2 Maximum and minimum luminance ratio	.....	13-12
▪ 13.4.6.3 Brightness ratio	.....	13-12
<b>Exhibit 13.4.6.3 Required brightness ratios</b>	.....	13-13

<b>13.4.7 Lighting fixtures and controls</b>	.....	<b>13-13</b>
▪ 13.4.7.1 Emergency lights	.....	13-13
▪ 13.4.7.2 Controls location	.....	13-13
▪ 13.4.7.3 Artificial illumination controls	.....	13-14
▪ 13.4.7.4 Control identification	.....	13-14
▪ 13.4.7.5 Flicker	.....	13-14
▪ 13.4.7.6 Protection from personnel activity	.....	13-14
▪ 13.4.7.7 Portable lights	.....	13-14
<b>13.5 Noise</b>	.....	<b>13-14</b>
<b>13.5.1 Hazardous sound levels</b>	.....	<b>13-14</b>
<b>Exhibit 13.5.1.1 Permissible exposure limits</b>	.....	13-15
▪ 13.5.1.1 Reducing sound levels	.....	13-14
▪ 13.5.1.2 Providing personal protection	.....	13-14
▪ 13.5.1.3 Noise exposure	.....	13-14
▪ 13.5.1.4 Monitoring results and corrective action	.....	13-15
▪ 13.5.1.5 Audiometric testing	.....	13-15
▪ 13.5.1.6 Hearing protection	.....	13-15
<b>13.5.2 Nonhazardous sound levels</b>	.....	<b>13-16</b>
□ 13.5.2.1 Acoustical design objectives	.....	13-16
▪ 13.5.2.2 Personnel acoustical environment	.....	13-16
▪ 13.5.2.3 General noise levels	.....	13-16
▪ 13.5.2.4 Noise criteria	.....	13-16
▪ 13.5.2.5 Extreme quiet areas	.....	13-16
▪ 13.5.2.6 Small office spaces and special areas	.....	13-16
▪ 13.5.2.7 Operational areas	.....	13-17
▪ 13.5.2.8 Equipment areas	.....	13-17
▪ 13.5.2.9 High noise, remote areas	.....	13-17
▪ 13.5.2.10 Occupational noise exposure and control	.....	13-17



## 13 Environment

This section contains human factors design guidelines pertaining to the workplace environment. The topics covered in this section include: (1) general criteria and guidelines, (2) ventilation, (3) temperature and humidity, (4) illumination, and (5) noise.

### 13.1 General guidelines

There are three major categories of environmental factors that affect systems and equipment design:

- a. environmental factors that design can control such as illumination, ventilation rate, and temperature,
  - b. environmental factors that are a function of design such as noxious substances, vibration, and noise, and
  - c. environmental factors that design cannot control such as solar radiation, dust, mud, and rain.
- **13.1.1 General environmental extremes.** To maximize the effectiveness of the FAA systems and equipment that are maintained by FAA personnel, the designer shall accommodate the environmental extremes to which the system will be subjected and their effects on human-system performance. FAA systems and equipment shall be capable of sustained operations within the climatic extremes specified in the material requirements documents pertaining to each system or specification. Maintenance workplaces shall conform to the guidelines specified in this document.
  - **13.1.2 Deviations from tolerable conditions.** When deviations from the tolerable conditions stated in this section are necessary, the designer should take into account adverse effects such as:
    - a. protective clothing or devices which affect the mobility, reach, workplace, access size, maintainability, time to restore, efficient and effective operation and maintenance,
    - b. reduced human performance,
    - c. conditions that have little or no direct effect on equipment, but may seriously impair the ability of the maintainer to perform effectively, and
    - d. conditions that contribute to longer maintenance time or to increased maintenance errors, oversights, or erroneous decisions, and that are detrimental to system availability and performance.

**Discussion.** The above adverse effects can sometimes be minimized through the use of alternatives such as: (1) remote maintenance monitoring, (2) increased workplace area, (3) individual protective measures or supplemental equipment, (4) decreased workloads, (5) acclimation of



operating personnel, (6) personnel rotation from one workstation to another, and (7) personnel selection and training.

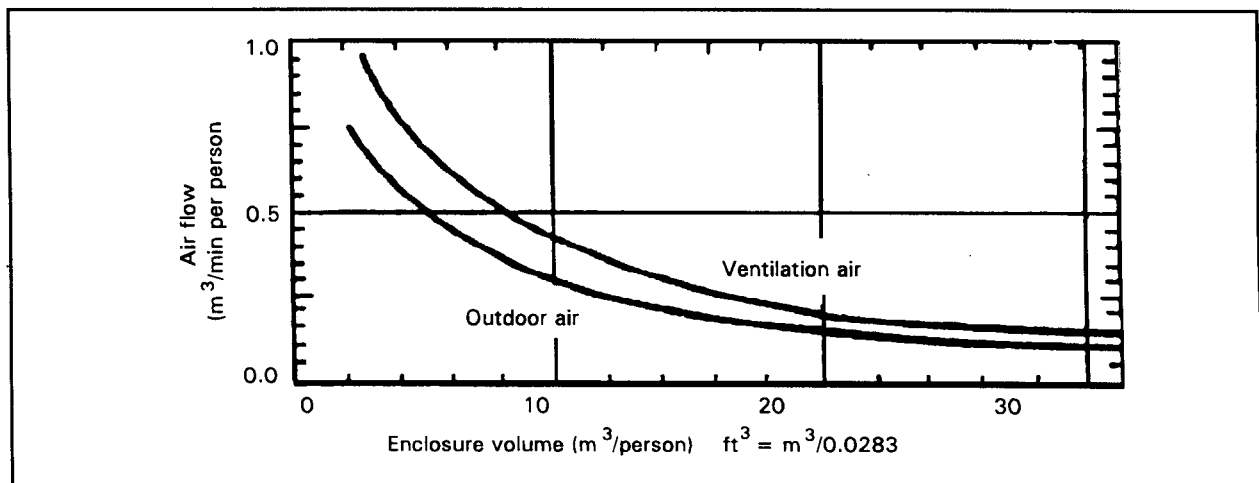
## 13.2 Ventilation

General ventilation of the workplace contributes to the comfort and efficiency of the workers. Good ventilation also makes a positive contribution to health. Adequate general and, if needed, specialized ventilation can ensure that concentrations of toxic substances do not reach levels that are hazardous to health.

**Definition. Ventilation** is the process of supplying air to or removing air from any space by natural or mechanical means. From the standpoint of comfort and health, ventilation issues involve both quantity and quality.

- **13.2.1 General ventilating systems and temperature differentials.** General ventilating systems shall not produce air velocities exceeding 100 ft/min. Temperature differentials between any two points within the workplace shall be maintained below 5.6°C (10°F).
- **13.2.2 Small enclosure ventilation.** If the enclosure volume is 4.25 m<sup>3</sup> (150 ft<sup>3</sup>) or less per person, a minimum of 0.85 m<sup>3</sup> (30 ft<sup>3</sup>) of ventilation air per minute shall be introduced into the enclosure; approximately two-thirds shall be outdoor air.
- **13.2.3 Large enclosure ventilation.** For large enclosures greater than 4.25 m<sup>3</sup> (150 ft<sup>3</sup>), the air supply per person shall be in accordance with the curves in exhibit 13.2.3. Air shall be moved past personnel at a velocity of not more than 60 m (200 ft) per minute. If personnel use manuals or loose papers, airspeed past these items shall not be more than 30 m (100 ft) per minute. If possible, the preferred air velocity of 20 m (65 ft) per minute shall be used to preclude manual pages from being turned or papers from being blown off work surfaces.

**Exhibit 13.2.3** Large enclosure ventilation



- **13.2.4 Verification of ventilation.** Performance of the ventilation system shall be verified by analysis, test, and verification.

**Discussion.** The analysis will ensure that enough fresh air is supplied to maintain occupant comfort and that toxic substances are properly ventilated. Tests will measure air velocity at all workplaces and ensure that no "dead air" spaces exist. A demonstration will verify that occupants do not experience discomfort due to inadequate ventilation.
- **13.2.5 Protective measures.** Ventilation or other protective measures shall be provided to maintain the levels of gases, vapors, dust, and fumes within the permissible exposure limits specified by 29 CFR 1910 and the limits specified in the American Conference of Governmental Industrial Hygienists Threshold Limit Values. If a discrepancy exists between these documents, 29 CFR 1910 shall take precedence.
- **13.2.6 Intakes.** Intakes for ventilation systems shall be located to minimize the introduction of contaminated air from sources such as exhaust pipes.
- **13.2.7 Control of toxic substances.** If exhaust systems or special ventilating systems are needed to control the concentration of toxic substances, a detailed analysis shall be conducted to identify the substances to be controlled, the health hazard of the substances, and the optimal location and orientation of the ventilating system. For instance, 29 CFR 1910 addressed ventilation requirements for special operations such as those involving grinding, polishing, buffing, spraying (29 CFR 1910.94) and welding (29 CFR 1910.252-257). Small confined spaces (inside tanks) present special ventilation problems that may require respirator support.
- **13.2.8 Monitoring of measurement procedures.** If control of toxic substances is a concern, approval of the test procedures and careful monitoring of the measurement procedures (including exposure records) shall be conducted by the appropriate FAA organization.

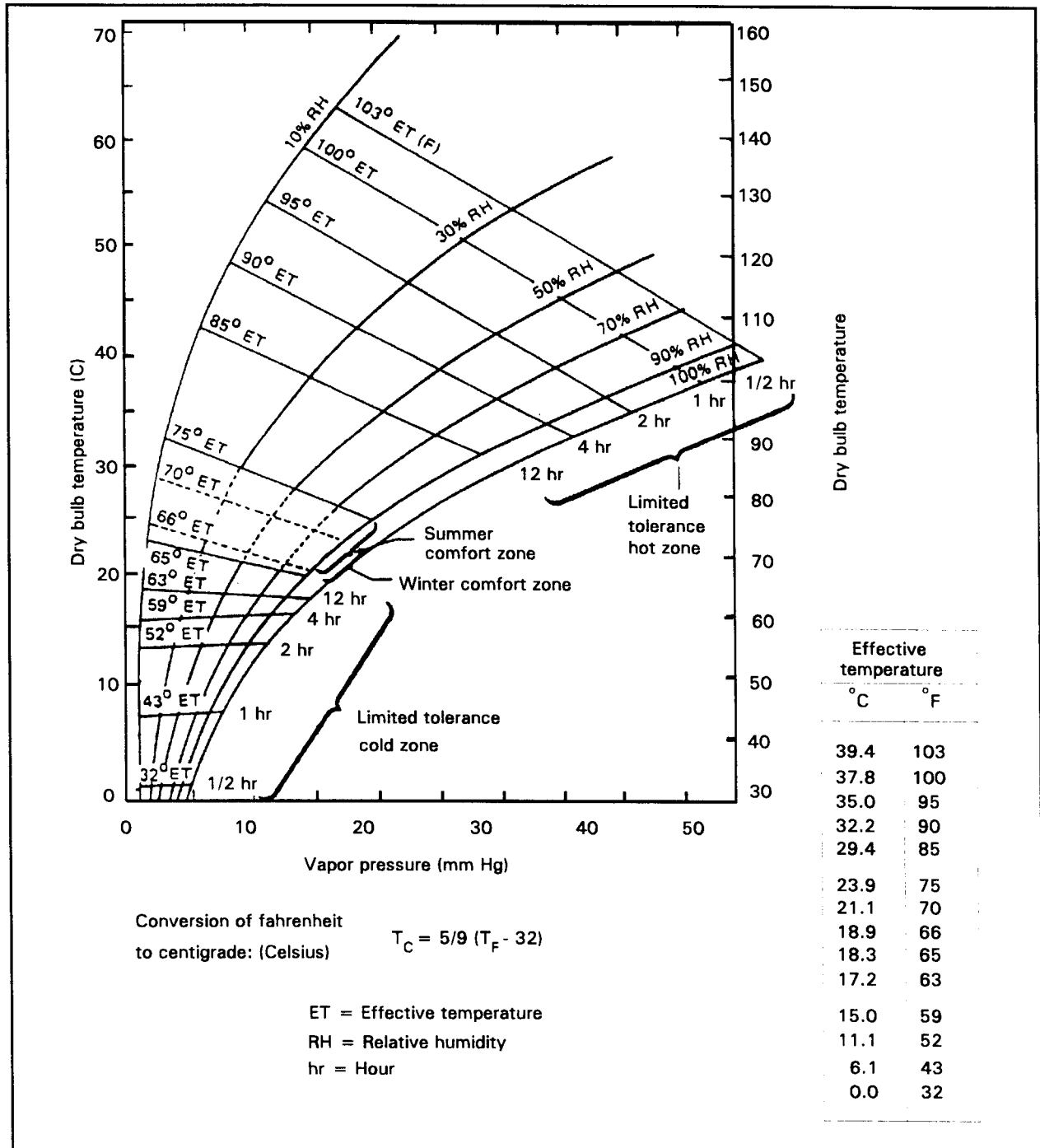
### 13.3 Temperature and humidity

Maintaining the workplace thermal environment within the range of human tolerance ensures the health, safety and efficiency of the worker.

Heat transfer relationships can become extremely complicated in terms of calculating individual heat balances in the workplace. A tool for determining workplace temperature requirements is the comfort zone chart shown in exhibit 13.3. The comfort zone varies, depending on clothing and workloads, as shown in the graph. A method of ensuring comfort, in cases where the proper temperature is unknown, is to allow the personnel to set the conditioning controls. In this way, the problem simply becomes one of engineering a heating or cooling system to cope with internal and external hot and cold sources.

Further information for the building environment, including offices, is contained in the latest edition of ANSI-ASHRAE Standard 55.

Exhibit 13.3 Comfort zone chart

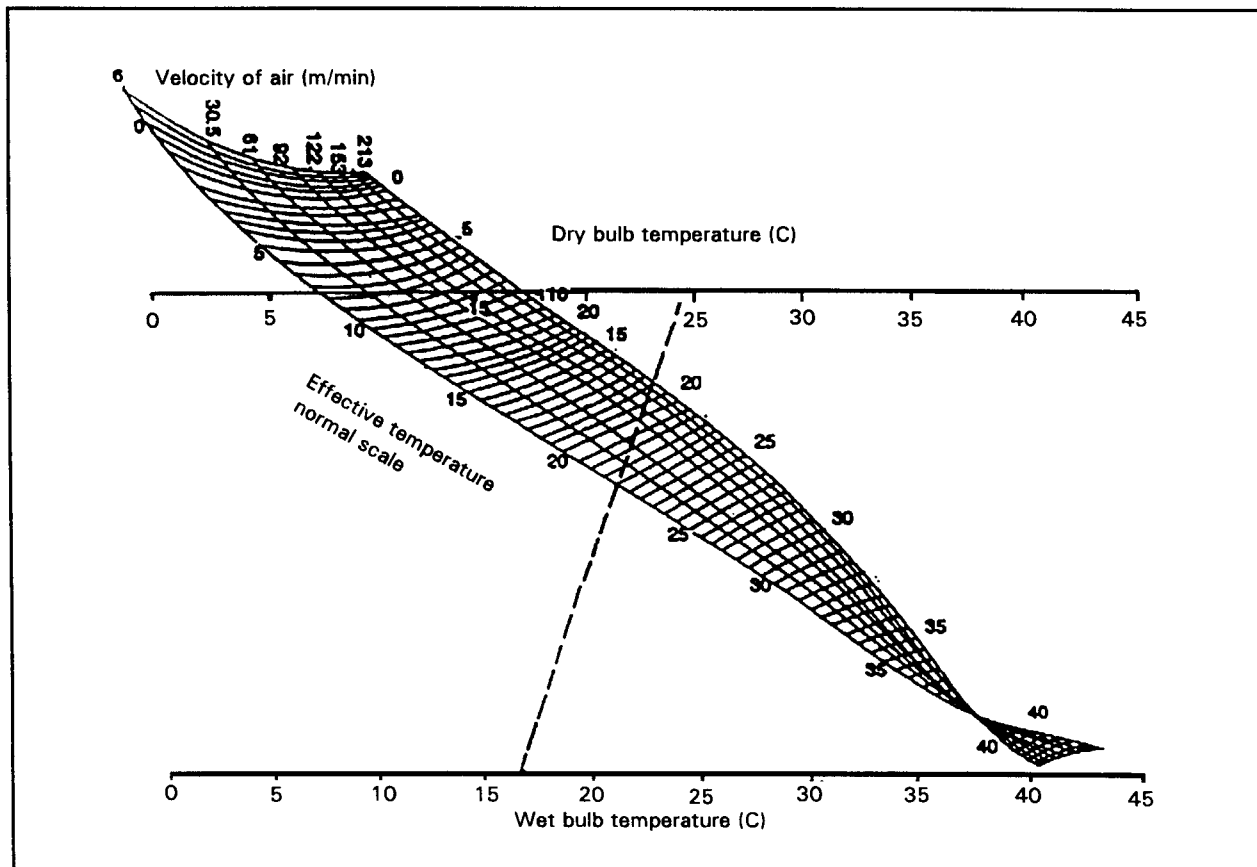


- **13.3.1 Thermal tolerance and comfort zones.** Temperature and humidity exposure should not exceed the effective temperature limits given in exhibit 13.3 when corrected for air velocity (see exhibit 13.3.1).

**Definitions.** The **comfort zone** is defined as that range of environmental conditions in which humans can achieve thermal comfort. It is affected by work rate, clothing, and state of acclimatization. **Thermal comfort** can be defined as a mental condition that is based upon the lack of perception of noticeable changes in temperature, and that results in a personal expression of satisfaction with the environment.

**Discussion.** The optimum temperature for personnel varies according to the nature of the tasks, the conditions under which the tasks are performed, and the clothing personnel are wearing. The optimum range of effective temperature for accomplishing light work while dressed appropriately for the season or climate is 21 - 27°C (70 - 80°F) in a warm climate or during the summer, and 18 - 24°C (65 - 75°F) in a colder climate or during the winter. Effective temperature for the environment can be derived from exhibit 13.3.

**Exhibit 13.3.1** Deriving effective temperature



- **13.3.2 Hot air discharge.** Heating systems shall be designed so that hot air discharge is not directed at personnel.

**Definition.** The **effective temperature** is an empirical thermal index that illustrates how combinations of dry bulb air temperature, wet bulb temperature, velocity of air, and clothing affect people. Numerically, it is equal to the temperature of still saturated air that would induce the same sensation, as shown in exhibit 13.3.1. This chart assumes a worker wearing customary indoor clothing and doing sedentary or light muscular work. It does not include any additional heat stress from special purpose clothing such as chemically protective clothing. Likewise, it does not consider radiant heat sources such as the sun or equipment components.

**Discussion.** To use the chart above, draw a straight line between dry bulb temperature and wet bulb temperature. The effective temperature is indicated at the point where this straight line crosses the appropriate value for velocity of air. (In this example, the effective temperature is 21.5°C for a dry bulb temperature of 24.5°C, a wet bulb temperature of 16.5°C, and an air velocity of 30.5 mpm).

- **13.3.3 Cold air discharge.** Air conditioning systems shall be designed such that cold air discharge is not directed at personnel.
- **13.3.4 Minimum effective temperature.** Minimum temperature requirements are dependent upon the tasks to be performed in specific applications. Within permanent and semi-permanent facilities, provisions shall be made to maintain an effective temperature (ET) not less than 18°C (65°F) (see exhibit 13.3.1), unless dictated otherwise by workload or extremely heavy clothing.
- **13.3.5 Maximum effective temperature.** The ET within enclosed workplaces for detailed work during extended periods shall be maintained at or below 29.5°C (85°F). This ET is considered the maximum limit for reliable human performance.
- **13.3.6 ET ranges as a function of work activity.** The ET ranges are flexible because they vary according to the amount of work activity. In general, the ranges should be extended upwards for tasks requiring minimal physical effort and downward for tasks requiring continuous muscular exertion. Dry bulb temperature should be decreased by 1.7°C for each 29 watts per hour increase in metabolic rate above the resting 117 watts per hour level. Relative humidity should be kept at or below 60% to allow sufficient evaporation to avoid perspiration.
- **13.3.7 Arctic clothing.** A person wearing arctic clothing should not be exposed to temperatures higher than 15.5°C (60°F); a temperature of 1.5° to 7.0°C (32° to 45°F) is optimal.
- **13.3.8 Temperature of enclosed workplaces.** The temperature throughout enclosed workplaces should be relatively uniform.

The temperature of the air at floor level and at head level should not differ by more than 5.6°C (10°F).

- **13.3.9 Side wall temperatures.** Side walls of enclosed workplaces should be kept at equal temperatures in so far as possible; however, temperature differences of 11°C (20°F) or less do not significantly degrade comfort.
- **13.3.10 Minimum relative humidity.** A minimum relative humidity of 15 percent should be maintained within all facilities to prevent irritation and drying of body tissues, for example, eyes, skin, and respiratory tract.
- **13.3.11 Relative humidity.** Approximately 45% relative humidity should be provided at 21°C (70°F). This value should decrease with rising temperatures.

**Discussion.** Humidity requirements may be driven by the requirement to maintain effective temperature levels.

- **13.3.12 Verification of humidity.** Humidity levels shall be verified by tests conducted during normal operations to ensure an acceptable level.

**Discussion.** If humidity level requirements are imposed, estimating is inadequate. Direct measurement is the only means of providing the desired accuracy.

- **13.3.13 Humidity measurements.** Humidity measurements should be taken at all personnel work stations.

## 13.4 Illumination

Criteria for appropriate illumination cannot be satisfied merely by providing a sufficient amount of light to perform tasks or by providing emergency lighting (approximately 32 lux) to enable personnel to operate important controls or to find the exit. The following factors need to be considered:

- a. the brightness contrast between each visual task object and its background,
- b. the glare from work surfaces and light sources,
- c. the level of illumination required for the most difficult tasks,
- d. the color composition of the illumination source and the equipment surfaces,
- e. the time and accuracy required in task performance, and
- f. the possible variations in operating conditions (such as outdoor panel blackout operation or outdoor panel visibility under bright sunlight) that may affect the lighting system, the task, or the personnel.

Design requirements are provided in this section for (1) illumination of specific tasks, (2) illumination for dark

adaptation, (3) glare from light sources, (4) reflected glare, (5) brightness ratios, (6) lighting fixtures and controls, and (7) workstation illumination.

### 13.4.1 General

In addition to the following illumination guidelines, see the "Lighting Handbook from the Illuminating Engineering Society", for general lighting design footcandle levels and formulas.

- **13.4.1.1 General and supplementary lighting.** Both general and supplementary lighting shall be used as appropriate to ensure that illumination is compatible with each operation and maintenance task situation.
- **13.4.1.2 Dimming capability.** A light dimming capability shall be provided.
- **13.4.1.3 Illumination in workplaces.** As a general rule, illumination in workplaces should eliminate glare and shadows that interfere with prescribed tasks.

**Definitions. Illumination** is the amount of light (luminance flux) falling on a surface. Measured in lumen/m<sup>2</sup> = lux = 0.093 ft-c. Illumination decreases with the square of the distance from a point source. **Luminance** is the amount of light per unit area emitted or reflected from a surface. Measured in candela per square meter (cd/m<sup>2</sup>), footlamberts (ft-L), or millilamberts (mL). 1.0 cd/m<sup>2</sup> = 0.31 mL = 0.29 ft-L. The luminance of a surface does not vary with the distance of the observer from the surface being viewed.

### 13.4.2 Illumination for the workplace and specific tasks

- **13.4.2.1 Lighting level.** The lighting level shall be measured on the work surfaces, (30 inches above the floor in the absence of work surfaces), or at visual interfaces, (for example, CRT and panels), where appropriate.
- **13.4.2.2 Illumination.** Workplace illumination shall be appropriate to the tasks to be accomplished. See exhibit 13.4.2.2 for illumination requirements.
- **13.4.2.3 Glare.** Lighting sources shall be designed and located to avoid creating glare from working and display surfaces, as viewed from any normal working position.

**Exhibit 13.4.2.2** Specific task illumination requirements

<b>Illumination levels</b>				
<b>Work area or type of task</b>	<b>Lux (ft - C)</b>			
	<b>Recommended</b>		<b>Minimum</b>	
Bench work				
rough	540	(50)	325	(30)
medium	810	(75)	540	(50)
fine	1615	(150)	1075	(100)
extra fine	3230	(300)	2155	(200)
Business machine operation (calculator, digital, etc)	1075	(100)	540	(50)
Console surface	540	(50)	325	(30)
Corridors	215	(20)	110	(10)
Dials	540	(50)	325	(30)
Electrical equipment testing	540	(50)	325	(30)
Emergency lighting	NA		30	(3)
Gauges	540	(50)	325	(30)
Inspection tasks, general				
rough	540	(50)	325	(30)
medium	1075	(100)	540	(50)
fine	2155	(200)	1075	(100)
extra fine	3230	(300)	2155	(200)
Machine operation, automatic	540	(50)	325	(30)
Meters	540	(50)	325	(30)
Office work, general	755	(70)	540	(50)
Ordinary seeing tasks	540	(50)	325	(30)
Panels				
front	540	(50)	325	(30)
rear	325	(30)	110	(10)
Passageways	215	(20)	110	(10)
Reading				
large print	325	(30)	110	(10)
newsprint	540	(50)	325	(30)
handwritten reports in pencil	755	(70)	540	(50)
small type	755	(70)	540	(50)
prolonged reading	755	(70)	540	(50)
Recording	755	(70)	540	(50)



**Exhibit 13.4.2.2 (continued)** Specific task illumination requirements

Work area or type of task	Illumination levels			
	Lux (ft - C)			
	Recommended		Minimum	
Repair work:				
general	540	(50)	325	(30)
instrument	2155	(200)	1075	(100)
Screw fastening	540	(50)	325	(30)
Service areas, general	215	(20)	110	(10)
Stairways	215	(20)	110	(10)
Storage				
inactive or dead	55	(5)	30	(3)
general warehouse	110	(10)	55	(5)
live, rough or bulk	110	(10)	55	(5)
live, medium	325	(30)	215	(20)
live, fine	540	(50)	325	(30)
Tanks, container	215	(20)	110	(10)
Testing				
rough	540	(50)	325	(30)
fine	1075	(100)	540	(50)
extra fine	2155	(200)	1075	(100)
Transcribing and tabulation	1075	(100)	540	(50)

### 13.4.3 Illumination levels to maintain dark adaptation

- **13.4.3.1 Maximum dark adaptation.** All transilluminated displays and controls shall be visible when all other lighting is turned off. If maximum dark adaptation is required, red lighting or low level white lighting [CIE color coordinates for x and y equals 0.330 +/- 0.030 (1932)] is acceptable.
- **13.4.3.2 Dark adaptation for task performance.** If dark adaptation is required for performance of tasks, the following steps shall be taken:
  - a. Low level lighting that minimizes loss of dark adaptation shall be provided for task performance.

- b. Areas requiring low level illumination shall be protected from external light sources.
- c. All external windows shall be provided with protective light shields (shades or curtains).
- d. All doors shall be light-proof when closed.

**Definition. Dark adaptation** is the process by which the eyes become more sensitive in dim light. The eyes adapt almost completely in about 30 minutes, but the time required for dark adaptation depends on the color, duration of exposure and intensity of the previous light.

**Discussion.** Ambient light is incompatible with dark adaptation. If it is dimmed enough so that it does not interfere with dark adaptation, it will not be bright enough by which to work. Minimum interference with adaptation is produced by brief exposure of the lowest intensity possible. Colors often appear different under different types of illumination, so unless a display will always be used under ambient light, do not use color coding.

- **13.4.3.3 Ambient light and dark adaptation.** Where both ambient light and dark adaptation are required, the conflict should be resolved by evaluating the priorities of the operator's tasks.

### 13.4.4 Glare from light sources

One of the most serious illumination problems is glare from surfaces. Relatively bright light shining into the observer's eyes as he or she tries to observe a dim visual field, and reflected glare from work surfaces are common causes of reduced performance in visual tasks. Glare not only reduces visibility of objects in the field of view but causes visual discomfort.

**Definition. Glare** is produced by any luminance within the visual field that is sufficiently greater than the luminance to which the eye is adjusted. Glare causes eye fatigue, discomfort, and annoyance, as well as interfering with visual performance and visibility.

- **13.4.4.1 Glare from artificial light sources.** The following measures shall be taken to avoid glare from artificial light sources:
  - a. Locate light sources so that they do not shine directly at personnel. Light sources shall not be located within 60° in any direction from the center of the visual field.
  - b. If additional lighting is needed, use dim light sources rather than bright ones.
  - c. Use polarized light, shields, hoods, lens, diffusers, or visors.
  - d. Use indirect lighting where possible.

- e. Ensure that the maximum to average luminance ratio does not exceed 5:1 across the viewing area. Six test readings shall be taken in the work area to determine the average luminance of the area.

**Definition. Luminance ratio** is the difference between the source of light of an object and its surroundings.

### 13.4.5 Reflected glare

- **13.4.5.1 Specular reflectance from the task area and the surrounding area.** Luminance of specular reflectance from the task area shall not be greater than 3 times the average luminance of the surrounding area.

**Definitions. A Specular surface** is one that provides a specular reflection, a shiny surface. **Reflectance** is the ratio of luminous flux reflected from a surface to luminous flux striking it.

- **13.4.5.2 Work surface reflection.** Work surface reflection shall be diffused and shall not exceed a reflectance of .2°.
- **13.4.5.3 Angle of incidence.** Direct light sources shall be arranged so their angle of incidence to the visual work area is not the same as the operator's viewing angle.
- **13.4.5.4 Polished surfaces.** Placement of smooth, highly polished surfaces within 60° of the maintainer's normal visual field shall be avoided.
- **13.4.5.5 Light source behind maintainer.** The placement of light sources behind maintainers which reflect glare into the maintainer's eyes shall be avoided.

### 13.4.6 Brightness ratio

- **13.4.6.1 Wall surface luminance.** Wall surface average luminance shall be within 50 to 80 percent of ceiling surface average luminance.
- **13.4.6.2 Maximum and minimum luminance ratio.** The maximum to minimum luminance ratio for any surface shall not exceed 10:1.
- **13.4.6.3 Brightness ratio.** The brightness ratios between the lightest and darkest areas or between a task area and its surroundings shall be no greater than specified in exhibit 13.4.6.3.

**Definition. Brightness** is an attribute of visual sensation that is determined by the intensity of light radiation reaching the eye.

**Exhibit 13.4.6.3** Required brightness ratios

<b>Comparison</b>	<b>Environmental classification</b>		
	<b>A</b>	<b>B</b>	<b>C</b>
Between lighter surfaces and darker surfaces within the task	5 to 1	5 to 1	5 to 1
Between tasks and adjacent darker surroundings	3 to 1	3 to 1	5 to 1
Between tasks and adjacent lighter surroundings	1 to 3	1 to 3	1 to 5
Between tasks and more remote darker surfaces	10 to 1	20 to 1	b
Between tasks and more remote lighter surfaces	1 to 10	1 to 20	b
Between luminaries and adjacent surfaces	20 to 1	b	b
Between the immediate work area and the rest of the environment	40 to 1	b	b

**Notes:**

- A - Interior areas where reflectances of entire space can be controlled for optimum visual conditions.
- B - Areas where reflectances of nearby work can be controlled, but there is only limited control over remote surroundings.
- C - Areas (indoor and outdoor) where it is completely impractical to control reflectances and difficult to alter environmental conditions.
- b - Brightness ratio control not practical.

### 13.4.7 Lighting fixtures

- **13.4.7.1 Emergency lights.** An independent, self-energizing illumination system shall be provided that will be automatically activated in the event of a major primary power failure or main lighting circuit malfunction resulting in circuit breaker interruption. If the back-up illumination system is a standby engine generator, it shall provide power within 15 seconds of a failure and shall be capable of sustained operation for a minimum of 72 hours. If the back-up illumination system is a standby battery system, it shall provide power immediately upon failure and shall be capable of sustained operation for a minimum of four hours.
- **13.4.7.2 Controls location.** Lighting controls shall be provided at entrances and exits of enclosed workplace areas.

- **13.4.7.3 Artificial illumination controls.** Lighting controls for artificial illumination of a workstation shall be located within the reach envelope of the maintainer at the display and control panel or workstation affected.
- **13.4.7.4 Control identification.** Lighting controls shall be illuminated in areas that are frequently darkened.
- **13.4.7.5 Flicker.** Light sources shall not have a perceptible flicker.
- **13.4.7.6 Protection from personnel activity.** Light sources shall be protected from damage by personnel activity.
- **13.4.7.7 Portable lights.** Portable lights shall be provided for illumination of inaccessible areas or as supplemental lighting for tasks.

## 13.5 Noise

Exposure to high levels of noise can cause hearing loss. The nature and extent of the hearing loss depends upon the intensity and frequency of the noise and the duration of the exposure. Noise induced hearing loss may be temporary or permanent. Temporary loss results from short-term exposure to noise; normal hearing returns after a period of rest. If exposures continue for extended periods of time, the temporary losses may become permanent. Noise-induced hearing loss resulting from prolonged exposure is irreversible. It can be arrested and prevented through administrative and engineering controls or through the use of ear protection.

### 13.5.1 Hazardous sound levels

- **13.5.1.1 Reducing sound levels.** Administrative or engineering controls shall be used to reduce sound levels within the permissible exposure limit (PEL). These PELs are established in FAA Order 3910.4 and are given in exhibit 13.5.1.1.
- **13.5.1.2 Providing personal protection.** If administrative or engineering controls fail to reduce sound levels within the PELs, personal protective equipment shall be provided and a continuing effective hearing conservation program shall be administered in accordance with FAA Order 3910.4.
- **13.5.1.3 Noise exposure.** Occupational noise exposure levels shall be predicted, tested, monitored, and computed in accordance with FAA Order 3910.4.

**Discussion.** Monitoring the noise levels will identify maintainers who are exposed to levels equal to or greater than:

- a. the 90 dBA, 8-hour time-weighted average (TWA) (or 100 percent dose) PEL, or

- b. the 85 dBA, 8-hour TWA (or 50 percent dose) action level.

**Definitions. Action level** is an 8-hour time-weighted-average noise level of 85 dBA or, equivalently, a noise dose of 50 percent, at which affected maintainers will be provided hearing protection and placed in an audiometric testing program. **Dose** is the accumulated exposure to noise.

**Exhibit 13.5.1.1** Permissible exposure limits

Duration per day (hours)	Sound level (dBA slow)
8.0	90
6.0	92
4.0	95
3.0	97
2.0	100
1.5	102
1.0	105
0.5	110
0.25 or less	115

Maximum exposure to impulse or impact noise is 140 dB peak sound pressure level.

- **13.5.1.4 Monitoring results and corrective action.** If testing or monitoring reveals that the 8-hour TWA exposure level is:

- a. less than 85 dBA (or 50 percent dose); no further action shall be required,
- b. equal to or greater than the action level, 85 dBA (or 50 percent dose), the maintainer(s) affected shall be provided hearing protection and placed in a hearing conservation program.
- c. equal to or greater than the PEL, 90 dBA (or 100 percent dose), the maintainer(s) affected shall be provided hearing protection and placed in a hearing conservation program, and feasible administrative and engineering controls shall be used to reduce the noise to acceptable levels.

- **13.5.1.5 Audiometric testing.** Audiometric testing program shall conform to FAA Order 3910.4.
- **13.5.1.6 Hearing protection.** Hearing protectors shall be required for all maintainers in a hearing conservation program.

## 13.5.2 Nonhazardous sound levels

- **13.5.2.1 Acoustical design objectives.** The acoustical design objectives for a work space should consider a balance of sound from all sources.

**Discussion.** Where appropriate the background noise level should be low enough to avoid interference with activity or speech, but high enough to mask intrusive sounds from adjacent spaces.

- **13.5.2.2 Personnel acoustical environment.** Personnel shall be provided with an acoustical environment that does not interfere with the performance of their tasks. They shall be protected from noise that could cause physical impairment.
- **13.5.2.3 General noise levels.** Workplace noise shall be maintained at levels that do not: (1) interfere with necessary voice, telephone, and radio communication, (2) cause fatigue or injury, and (3) degrade overall system effectiveness (same as 12.12.1).
- **13.5.2.4 Noise criteria.** Noise criteria are defined by both the A-weighted sound level, dB(A), and the preferred speech interference level, PSIL-4. Use of the A-weighted sound level is preferable. Where it is not possible to meet the specified A-weighted sound level requirement, the corresponding PSIL-4 requirement shall be met (same as paragraph 12.12.2).

**Definitions. Preferred speech interference level (PSIL-4)** is a measure of the effectiveness of noise in masking speech. **Speech interference level (SIL or SIL-4)** is the arithmetic mean, in dB (or  $20\mu$  Pa), of sound pressure levels in the four octave bands with center frequencies of 500, 1000, 2000, and 4000 Hz. **A-weighted sound level (dB(A))** is a sound pressure level (in decibels) measured using a sound level meter with an A-weighting network. The A-weighted response is maximum at 2500 Hz, drops rapidly as frequency decreases below 1000 Hz, and gradually increases above 4000 Hz, thereby approximating the frequency dependent human response to moderate sound levels. ANSI S1.4 gives the definition of A-weighting filter characteristics.

- **13.5.2.5 Extreme quiet areas.** Ambient noise in areas requiring extreme quiet shall not exceed 35 dB(A) or 27 dB PSIL-4 (same as paragraph 12.12.3).
- **13.5.2.6 Small office spaces and special areas.** Ambient noise in areas requiring no difficulty with speech communication (for example, libraries and classrooms) shall not exceed 45 dB(A) or

37 dB PSIL-4; conference rooms and offices shall not exceed 38 dB PSIL-4 (same as paragraph 12.12.4).

- **13.5.2.7 Operational areas.** Ambient noise in areas requiring frequent phone use or requiring occasional speech communication (for example, operations centers, control rooms, tower cabs, and dynamic simulation rooms) at distances up to 4.6 m (15 ft) shall not exceed 55 dB(A) or 47 dB PSIL-4; shop offices and laboratories shall not exceed 48 dB PSIL-4 (same as paragraph 12.12.5).
- **13.5.2.8 Equipment areas.** Ambient noise in areas requiring frequent telephone use or frequent speech communication (for example, computer rooms, engineering areas, equipment rooms, and telephone switching centers) at distances up to 1.5 m (5 ft) shall not exceed 65 dB(A) or 57 dB PSIL-4 (same as paragraph 12.12.6).
- **13.5.2.9 High noise, remote areas.** High noise, remote areas that are normally unmanned shall not exceed 85 dB(A) (same as paragraph 12.12.7).
- **13.5.2.10 Occupational noise exposure and control.** Administrative or engineering controls shall be used to reduce the sound levels to within permissible noise exposure levels listed in exhibit 12.12.7. 29 CFR 1910.95 shall be used in determining equivalent A-weighted sound levels for daily exposure. A hearing conservation program shall be administered any time an employee's noise exposure equals or exceeds an 8-hour time weighted average of 85 db measure on the A scale (slow response) or equivalent without regard to attenuation that may be provided by personal protective equipment. 29 CFR 1910.95 shall govern the hearing protection program (same as paragraph 12.12.8).



## Section 14 contents

<b>14 Anthropometry and biomechanics</b> .....	<b>14-1</b>
<b>14.1 General application of anthropometric and biomechanical data</b> .....	<b>14-1</b>
<b>14.1.1 User population</b> .....	<b>14-1</b>
▪ 14.1.1.1 Use of data .....	14-2
▪ 14.1.1.2 Data to be used .....	14-2
▪ 14.1.1.3 Using population extremes .....	14-2
<b>14.1.2 Using design limits</b> .....	<b>14-2</b>
▪ 14.1.2.1 Selecting the correct human physical and associated measurement characteristics .....	14-3
▪ 14.1.2.2 Selecting the appropriate distribution information .....	14-4
▪ 14.1.2.3 Selecting the correct percentile statistic .....	14-4
▪ 14.1.2.4 Clearance dimension at the 95th percentile .....	14-6
▪ 14.1.2.5 Clearance dimension at the 99th percentile .....	14-7
▪ 14.1.2.6 Limiting dimension at the 5th percentile .....	14-7
▪ 14.1.2.7 Limiting dimension at the 1st percentile .....	14-7
▪ 14.1.2.8 Adjustable dimensions .....	14-7
▪ 14.1.2.9 Sizing determinations .....	14-7
▪ 14.1.2.10 Critical life support equipment .....	14-8
<b>14.1.3 Avoiding pitfalls in applying anthropometric data</b> .....	<b>14-8</b>
▪ 14.1.3.1 Misuse of the 50th percentile or of the average .....	14-8
▪ 14.1.3.2 Misperception of the typically sized person .....	14-8
▪ 14.1.3.3 Summation of segment dimensions .....	14-8

<b>14.1.4 Solving a complex sequence of design problems</b>	.....	<b>14-9</b>
▪ 14.1.4.1 Design to body positions and motions of the tasks	.....	14-9
▪ 14.1.4.2 Construction or collection of unique position data	.....	14-9
▪ 14.1.4.3 Design reference points and zones	.....	14-9
□ 14.1.4.4 Building and using reach envelopes	.....	14-10
□ 14.1.4.5 Building visual envelopes or footprints	.....	14-10
□ 14.1.4.6 Building design solutions	.....	14-10
▪ 14.1.4.7 Effects of clothing	.....	14-10
<b>Exhibit 14.1.4.7 Additive effects of clothing on anthropometric measures</b>	.....	14-11
▪ 14.1.4.8 Effects of tools and equipment lifted or carried	.....	14-12
<b>14.1.5 Use of distribution and correlation data</b>	.....	<b>14-13</b>
□ 14.1.5.1 Gaussian distribution of measurement values on a single human physical characteristic	.....	14-13
<b>Exhibit 14.1.5.1 Percentile values</b>	.....	14-13
□ 14.1.5.2 Using bivariate distribution data	.....	14-13
□ 14.1.5.3 Use of correlation and multiple correlation data	.....	14-14
<b>14.1.6 Use of models</b>	.....	<b>14-14</b>
▪ 14.1.6.1 Data applicable to the design problem	.....	14-15
▪ 14.1.6.2 Common errors	.....	14-15
▪ 14.1.6.3 Use of design limits approach	.....	14-15
▪ 14.1.6.4 Model treatment of multiple variables	.....	14-15
▪ 14.1.6.5 Joint mobility and reach interaction	.....	14-15
<b>14.2 Anthropometric variability factors</b>	.....	<b>14-15</b>
□ 14.2.1 Foreign populations	.....	14-15
□ 14.2.2 Race	.....	14-15
□ 14.2.3 Body slump	.....	14-15

<b>14.3 Anthropometric and biomechanical data</b>	.....	<b>14-16</b>
<b>14.3.1 Data usage</b>	.....	<b>14-16</b>
▪ 14.3.1.1 Use of anthropometric and biomechanical data	.....	14-16
▪ 14.3.1.2 Task considerations	.....	14-16
<b>14.3.2 Static body characteristics</b>	.....	<b>14-16</b>
□ 14.3.2.1 Static data	.....	14-16
<b>Exhibit 14.3.2.1</b> Static human physical characteristics (head)	.....	14-18
<b>Exhibit 14.3.2.1</b> Static human physical characteristics (seated)	.....	14-22
<b>Exhibit 14.3.2.1</b> Static human physical characteristics (standing)	.....	14-26
<b>Exhibit 14.3.2.1</b> Static human physical characteristics (standing position and hands)	.....	14-30
▪ 14.3.2.2 Relevant static anthropometric data	.....	14-17
<b>14.3.3 Dynamic (mobile) body characteristics</b>	.....	<b>14-30</b>
<b>14.3.3.1 Range of whole body motion</b>	.....	<b>14-30</b>
▪ 14.3.3.1.1 Trunk movement	.....	14-31
▪ 14.3.3.1.2 Whole body movement	.....	14-31
<b>14.3.3.2 Joint motion</b>	.....	<b>14-31</b>
▪ 14.3.3.2.1 Single joint movements	.....	14-31
<b>Exhibit 14.3.3.2.1</b> Joint movement ranges	.....	14-32
▪ 14.3.3.2.2 Range of motion for two joints	.....	14-34
<b>Exhibit 14.3.3.2.2</b> Change in range of joint movement with movement in an adjacent joint	.....	14-35
▪ 14.3.3.2.3 Design limit approach	.....	14-35



<b>Exhibit 14.5.3.1</b> Horizontal push and pull forces that can be exerted .....	14-47
□ <b>14.5.3.2</b> Vertical direction of force .....	14-48
<b>Exhibit 14.5.3.2</b> Static muscle strength data for vertical pull exertions .....	14-49
□ <b>14.5.3.3</b> Forces for handles .....	14-48
<b>14.5.4 Lifting and carrying</b> .....	<b>14-52</b>
■ <b>14.5.4.1</b> Lifting and carrying limits .....	14-52
<b>14.6 Design for physical comfort</b> .....	<b>14-52</b>
□ <b>14.6.1</b> Adjustment capabilities .....	14-52
□ <b>14.6.2</b> Restrictions to movement .....	14-52
□ <b>14.6.3</b> Body support .....	14-53
■ <b>14.6.4</b> Body posture .....	14-53
■ <b>14.6.5</b> Demands upon tasks .....	14-53



## 14 Anthropometry and biomechanics

Designers and human factors specialists incorporate scientific data on human physical capabilities into the design of systems and equipment. Human physical characteristics, unlike those of machines, cannot be designed. However, design oversight can place unnecessary demands and restrictions upon user personnel.

**Definitions.** **Anthropometry** is the scientific measurement and collection of data about human physical characteristics and the application (engineering anthropometry) of these data in the design and evaluation of systems, equipment, manufactured products, human-made environments, and facilities. **Biomechanics** describes the mechanical characteristics of biological systems, in this case the human body, in terms of physical measures and mechanical models. This field is interdisciplinary (mainly anthropometry, mechanics, physiology, and engineering). Its applications address mechanical structure, strength, and mobility of humans for engineering purposes.

This final technical section of the HFDG provides additional anthropometric and biomechanics data beyond that used in previous technical sections. Previous data are cross referenced, where appropriate. Unlike the other sections, this section provides more guidance about the nature of the data, its selection, and its proper use. It provides rules for applying the vast amount of human form data available to specific design fit, function, and human task performance.

The section also covers application principles and their resulting rules, human body measurement data (static and dynamic), range of motion and strength data, as well as comfort information.

### 14.1 General application of anthropometric and biomechanics data

In this document, body size, strength, and mobility data are presented to represent the current FAA maintenance population. In the future, this population will include a wider range of ethnic backgrounds. Minorities and females are expected to increase. The average age is expected to decrease. These changes will be important for future systems design.

In this general section, design criteria and guidelines are given for: (1) ascertaining user population data, (2) using the design limits approach, (3) avoiding pitfalls in applying the data, (4) using distribution and correlation data, (6) solving design problems, and (7) using models.

#### 14.1.1 User population

Anthropometric data are most appropriate when they are derived from a survey of the existing worker population of interest. Since the sub-population associated with the FAA has not been surveyed, information from substitute sources is used as a basis for design.

- **14.1.1.1 Use of data.** Anthropometric and biomechanics data shall be used in the design of systems, equipment (including personal protection equipment), clothing, workplaces, passageways, controls, access openings, and tools.

**Discussion.** The human's interface with other system components needs to be treated as objectively and systematically as are other interface and hardware component designs. It is not acceptable to guess about human physical characteristics or to use the designer's own measurements or the measurements of associates. Application of appropriate anthropometric and biomechanics data is expected.

- **14.1.1.2 Data to be used.** Designers and human factors specialists shall use the anthropometric and biomechanics data provided in this guide. If additional data are needed, they shall use the more complete data given in DoD-HDBK-743. If other reference or new data collections are considered, the contractor shall obtain the approval of the acquisition program office.

**Discussion.** If this guide does not present data needed for the problem at hand, the designer will have to select appropriate sample information from DoD-HDBK-743. In that handbook, the 1988 military male and female survey distributions can be used to represent FAA maintenance personnel when needed, as it represents the most comprehensive samples available. Note that civilian working populations could be expected to have a larger range of sizes and ages than the military. Samples with comprehensive measures are not available.

- **14.1.1.3 Using population extremes.** Designers and human factors specialists shall draw upon the extremes of the larger male population distribution and the extremes of the smaller female population distributions to represent the upper and lower range values, respectively, to apply to anthropometric and biomechanics design problems.

**Discussion.** The use of separate male and female population data is a conservative approach that results in more inclusive design dimensions than the same percentiles would from a composite population.

### 14.1.2 Using design limits

Initial rules in this section address the design limits approach. To understand this approach it is helpful to consider the overall steps and choices that one makes in applying anthropometric and biomechanics data. The design limits approach entails selecting the most appropriate percentile values in population distributions and applying the appropriate associated data in a design solution. These steps are listed in this introductory material and are explained in detail in the initial three guidelines of this subsection. If the reader has applied the design limit approach and understands it, the reader can skip the rest of this introductory material as well as the explanations associated with the first three guidelines, do not skip the guidelines.



**Definition. The design limits approach** is a method of applying population or sample statistics and data about human physical characteristics to a design so that a desired portion of the user population is accommodated by the design. The range of users accommodated is a function of limits used in setting the population portion.

To understand the design limits approach it is helpful to consider step by step the choices that design personnel make in applying these human physical data.

- a. Select the correct **human physical characteristic** and its applicable **measurement characteristic** (description) for the design problem at hand.
- b. Select the appropriate **population, representative sample, or guideline information** on the selected human physical characteristic and measurement description to apply to the design problem.
- c. Determine the appropriate **statistical point(s)**, usually **percentile points** from guideline information or from the sample distribution(s) in order to accommodate a desired range of the human characteristic within the distribution of the user population.
- d. Read directly or determine statistically the **measurement value(s)** that corresponds to the selected statistical point(s) relevant to the population distribution.
- e. Incorporate the measurement value as a **criterion for the design dimension**, or in the case of biomechanics data, for the movement or force **solution** in the design problem.

The design limits approach is accomplished during the selection of percentile value(s) as the statistical point(s) in step c above. Steps (a) and (b) are explained under the first two rule paragraphs below. Steps (c), (d) and (e) are explained under the third rule paragraph below. The terms in bold above are defined in the rules that follow. An example problem covering all steps follows the third rule in paragraph 14.1.2.3. Different percentile values apply to design issues involving clearance, reach limits, adjustments, and sizing. These types of design limits problems are covered in paragraphs 14.1.2.4 through 14.1.2.9.

- **14.1.2.1 Selecting the correct human physical and associated measurement characteristics.** Design personnel shall select human and measurement characteristics that are relevant to the component of design under consideration and are based upon:
  - a. an analysis of human tasks associated with the system, equipment, facility, or environment,
  - b. consideration of normal, degraded, or emergency modes of task activities, and

- c. consideration of the importance and frequency of expected task performance.

**Definitions. Human physical and associated measurement characteristics** refer to specific physical, mobility, or strength features of human users and to the explicit way that a human feature or capability is measured for use as general anthropometric or biomechanics data or as data for a specific design.

**Explanation.** (Step a from 14.1.2). Select the correct human physical characteristic and its applicable measurement description for the design problem at hand. The associated measurement description tells how measurements are taken for population or sample distribution data. The decision to use a particular characteristic is one of selecting the correct variable(s) for the problem. If the problem calls for biomechanics information, for example, strength information, the same initial step of identifying the specific human characteristic and how it is measured would apply.

- **14.1.2.2 Selecting the appropriate distribution information.** When the design limits approach is used, designers and human factors specialists shall select the appropriate sample distribution (including the male, female, and nationality compositions) from guideline, handbook, or survey sources.

**Discussion.** Information presented in this guide is derived from the most relevant distributions for the users and for the general problem areas. Part of the selection process may be to choose the most appropriate male or female distribution information.

**Explanation.** (Step b from 14.1.2). Select the appropriate **population, representative sample, or guideline information** appropriate for guideline data on the selected human physical characteristic and its measurement description that applies to a design problem.

A **population distribution** has certain defining parameters. For instance, a population mean and variance are sufficient to define a known normal (or Gaussian) distribution (the bell shaped curve associated with the variability of many human characteristics).

Usually, the entire population of users has not been measured so sample distribution data and statistics are generally used. Information from large samples can estimate population parameters and thus can be used.

- **14.1.2.3 Selecting the correct percentile statistic.** Design criteria for a human physical integration problem shall be based upon the range of the population to be accommodated. Designers and human factors specialists shall determine the appropriate statistical points, usually percentile statistics, to accommodate an

appropriate range of the population distribution for the specific design problem.

**Definitions.** The **percentile statistic** is determined by ranking all data values (using the applicable measurement values related to the selected human physical characteristic) in the sample and determining the percentage of data that fall at or below a specific datum value. This percentage is known as the **percentile value** (or point) of the selected datum.

By definition, the point below which five percent of the data values fall is known as the **5th percentile statistic**. The point below which one percent of the data falls is known as the 1st percentile. Similarly, the midpoint of the distribution is the point below which 50 percent of the data falls and is defined as the 50th percentile. To accommodate 95 percent of the population or sample, choose the **95th percentile statistic**, to accommodate all but the top one percent choose the **99th percentile statistic**.

**Explanation.** (Step c from 14.1.2). Determine the appropriate **statistical point(s)**, usually **percentile points**, from guideline information or from a sample distribution, in order to accommodate the desired range of the human characteristic within the distribution of the user population.

Usually, for design purposes, it is impractical to accommodate the extremes of the distribution because there is so much variability at the extremes and so few cases. Often, persons who are extreme in dimensional measurement values (in the lowest or highest one percent) know it, and they behave so as to compensate for the designed portions of their environments.

In step c, designers select the most applicable **statistical point(s)** from the appropriate distribution to accommodate the portion of the population that is appropriate to the design problem. The design limits approach involves selecting the appropriate **percentile statistic(s)**. It was previously noted that different kinds of design problems (clearance, reach, adjustment, and sizing) call for different strategies and result in the selection of different percentile statistics.

(Step d). Read directly or determine statistically the appropriate **measurement value** (or datum value) that corresponds to the selected statistical point relevant to the population (or applicable sample) distribution.

For any percentile statistic used as applicable to a design problem, there is a measurement value or data point that corresponds to the criterion percentile statistical value. This measurement value can be calculated or counted

from the rank order data distribution, or it can be read directly from a tabular or graphical representation of the distribution.

If population distribution characteristics (for example, normality) and population parameters (for example, mean and variance) are known, then other statistical properties can be determined (for instance, percentiles and associated measurement values (see paragraph 14.1.5.1).

(Step e). Incorporate the measurement value as a criterion for the design dimension (or, in the case of biomechanics data, for the movement or force solution) in the design problem.

The actual measurement value is used as the design dimension, force, or movement solution to the design problem at hand. Since the example design problem is one of accommodating the reach capabilities, the designer will chose the female distribution to represent the shorter reach capabilities in the population.

**Example.** A designer who has an application problem involving human reach capabilities decides (step a) that the human physical characteristic "functional (thumb-tip) reach" is applicable to this reach problem. In this case the associated measurement description is as follows: the horizontal distance from the wall to the tip of the thumb is measured with the subjects' shoulders against a wall, the arm extended forward, and the index finger touching the tip of the thumb. (See exhibit 14.3.2.1, physical characteristic 43.) ( Step b) The designer would like to have distribution information from a composite population which includes both male and female data and which represents the applicable FAA population. Since no such survey data exist for this population, this guide directs (14.1.1.2) that substitute distribution data for separate male and female populations be used (see exhibit 14.3.2.1). Since the example design problem is one of accommodating the reach capabilities, the designer in step b will chose the female distribution to represent the shorter reach capabilities in the population. In step c the most appropriate percentile statistic would be the 5th percentile of the female sample distribution. This point would assure that the reach of almost all male and female personnel except those smaller than the 5th percentile female would be accommodated. In step d of the example, the measurement value for the 5th percentile female is 67.7 cm (26.7 in) as read from exhibit 14.3.2.1, physical characteristic 43. In step e of the design example above, the 67.7 cm (26.7 in) value would be used as the criterion dimension in the design to accommodate personnel reach.

- **14.1.2.4 Clearance dimension at the 95th percentile.** Design clearance dimensions which must accommodate or allow passage

of the body or parts of the body shall be based upon the 95th percentile of the male distribution data.

- **14.1.2.5 Clearance dimension at the 99th percentile.** If a certain clearance design dimension is critical to the activities of the entire population or could be life threatening to likely users who are at the larger extremes of the distribution, then a human measurement value that is at least the 99th percentile male shall be used as the criterion design dimension.

**Discussion.** Whole body clearance dimensions for frequently used passageways and dimensions for critical escape hatches need to be based on the 99th percentile statistic. This practice ensures 99 percent of the user population who are smaller than this measurement value will have proper clearance.

- **14.1.2.6 Limiting dimension at the 5th percentile.** Limiting design dimensions, such as reach distances, control movements, display and control locations, test point locations, and handrail positions, that restrict or are limited by body or body part size, shall be based upon the 5th percentile of female data for applicable body dimensions.

**Discussion.** For example, the maximum height from floor level to an accessible part of any piece of equipment needs to be within reach of the 5th percentile female maintainer, which will ensure that at least 95 percent of the user population can access this part of the equipment.

- **14.1.2.7 Limiting dimension at the 1st percentile.** If certain limiting design dimensions are critical to the activities of the entire population or could be life threatening to likely users who are at the smaller extremes of the applicable distribution, then the 1st percentile of the female distribution shall be used as the basis for the criterion dimension.

**Discussion.** Dimensions for reaching emergency or lifesaving equipment are examples where access cannot be denied to the smaller extremes of the population.

- **14.1.2.8 Adjustable dimensions.** Any equipment dimensions that need to be adjusted for the comfort or performance of the individual user shall be adjustable over the range of the 5th to 95th percentiles.
- **14.1.2.9 Sizing determinations.** Clothing and certain personal equipment dimensions that need to conform closely to the contour of the body or body parts shall be designed and sized to accommodate at least the 5th through the 95th percentile range. If necessary, this range shall be accommodated by creating a number of unique sizes, where each size accommodates a segment of the population distribution. Each segment can be bounded by a small range of percentile values.

### 14.1.3 Avoiding pitfalls in applying anthropometric data

- **14.1.2.10 Critical life support equipment.** Dimensions or sizes of critical life support equipment shall accommodate, at least, the range defined by the 1st through the 99th percentiles of the distribution.

There are several common errors to be avoided by designers when they apply anthropometric data to design. These are: (1) designing to the midpoint (50th percentile) or average, (2) the misperception of the typical sized person, (3) generalizing across human characteristics, and (4) summing of measurement values for like percentile points across adjacent body parts.

- **14.1.3.1 Misuse of the 50th percentile or of the average.** The 50th percentile or mean shall not be used as design criteria as it accommodates only half of the users.

**Discussion.** When the population distribution is Gaussian (normal), the use of either the 50th percentile or the average for a clearance would, at best, accommodate half the population.

- **14.1.3.2 Misperception of the typically sized person.** Designers or human factors specialists shall not use the concept of a typically sized person where the same percentiles values are expected across many dimensions. A person at the 95 percentile in height is unlikely to measure at the 95th percentile in reach or other dimensions. A percentile value and its measurement value that pertains to a particular body part shall be used exclusively for functions that relate to that body part.

**Discussion.** When the middle 30 percent of a population of 4000 men was measured on 10 dimensions, only one-fourth of them were "average" in a single dimension (height), and less than 1 percent were average in five dimensions (height, chest circumference, arm length, crotch height, and torso circumference). Keeping in mind that there is not an "average person," one also must realize that there is not a "5th percentile person" nor a "95th percentile" person. Different body part dimensions are not necessarily highly correlated. An implication is that one can not choose a person who is 95 percentile in stature as a test subject for meeting 95 percentile requirements in reach or other dimensions.

- **14.1.3.3 Summation of segment dimensions.** Summation of like percentile values for body components shall not be used to represent any human physical characteristic that appears to be a composite of component characteristics.

**Discussion.** The 95th percentile arm length, for instance, is not the addition of the 95th percentile shoulder-to-elbow length plus the 95th percentile elbow-to-hand length. The actual 95th percentile arm length will be somewhat less than the erroneous summation. To determine the 95th percentile arm length, one must use a

distribution of arm length rather than component part distributions.

#### 14.1.4 Solving a complex sequence of design problems

In this section, rules are presented for approaching complex design problems that requires the consideration of a sequence of relevant design reference locations (such as seat reference points and eye reference zones), human physical characteristics, statistical points, and measures. The recommended approach involves identifying the necessary human activities and positions and establishing reference points and envelopes for the necessary activities. These envelopes impact the location and design of controls and displays as well as the placement of work surfaces, equipment, and seating accommodations. The effects of clothing or carried equipment are then used to expand the dimensions.

- **14.1.4.1 Design to body positions and motions of the tasks.** Design personnel shall base the necessary operator and maintainer body positions and motions on personnel tasks to be performed during normal, degraded, and emergency modes of operations and maintenance. If the human physical characteristics associated with common or mobile working positions as presented and illustrated in section 9.4 are applicable to the jobs and tasks, the associated distribution and measurement values shall be used.
- **14.1.4.2 Construction or collection of unique position data.** If the common and mobile working positions data in section 9.4 of this guide do not represent the unique working positions associated with a design, then design personnel shall construct the applicable human physical characteristics and measures from the static and dynamic data provided later in sections 14.3.2 and 14.3.3 or in DoD-HDBK-743. If no applicable data can be found or calculated for important design measures, then, with the prior approval of the acquisition program office, sample measures shall be taken on appropriate personnel for the unique working positions.

**Discussion.** Anthropometric measurement needs to be done by professionals because there are many complexities and potential interactions among positions of body segments, as well as many technical points and pitfalls to avoid in measurement practice. Sample measurement methods can be found in Roebuck, Kroemer, and Thomas, 1975.

- **14.1.4.3 Design reference points and zones.** Design reference points or zones that are key to the relationship between personnel and hardware or facility design shall be based upon the anthropometry of the necessary working positions. Such reference points and zones include seat reference points, arm rotation points, eye reference points or zones, visual envelopes, and mobility or comfort adjustment ranges. These reference points may have design practice definitions in certain application area such as cockpit design or commercial seating. These standard practices can be used, when applicable. However for both standard or unique designs practices, explicit definitions

used shall accompany each specific application project and the relationships between these points or zones, user physical characteristics, and task requirements shall be explicit.

- **14.1.4.4 Building and using reach envelopes.** If reach data provided in this guide (see section 14.4) do not apply to a specific design problem, then reach design dimensions or envelopes for design use should be constructed considering:
  - a. one-handed or two-handed operation,
  - b. grasp requirements which may affect the functional reach envelope,
  - c. positional relationship of a shoulder reference point or arm rotation point to the seat back, seat reference point, or other posture reference or design reference points, and
  - d. the appropriate samples and anthropometric measurements from the data provided in this guide or in DoD-HDBK-743 (see paragraph 14.1.1.2).
- **14.1.4.5 Building visual envelopes or footprints.** Once eye reference points and or zones are established, design personnel should project the visual areas around the line of sight for visual tasks. Visual envelopes or footprints can show if equipment locations may interfere with necessary visual tasks. Similarly, they show where displays can be located to ensure appropriate legibility and information use. Paragraph and exhibit 7.1.2.6.9 address display locations in relation to line-of-sight perspectives.
- **14.1.4.6 Building design solutions.** Many problems associated with integrating human physical characteristics into a design involve building a series of dimension criteria. If feasible, each criterion dimension should be based upon the design limit approach to the appropriate single human physical characteristic for the body segment appropriate to the design problem. Static and dynamic data (see section 14.3) are used as the design details are planned and iterated. If appropriate, composite characteristics and measures should be used as addressed in paragraph 14.1.5.3.

**Discussion.** In design work, measurements are seldom used alone. Sitting height and functional reach are used in the design of consoles, while hip breadth, sitting and popliteal height are required for the design of seating.

- **14.1.4.7 Effects of clothing.** Because most anthropometric data presented in this guide and in other data sources represent nude body measurements (unless otherwise indicated), suitable allowances shall be made for light, medium, or heavy clothing and for any special protective equipment that is worn. Exhibit 14.1.4.7 illustrates the additive effects of clothing on static body dimensions and shows the 95th percentile gloved hand measures. If special items of protective clothing or equipment are involved, the effects shall be measured in positions required by the users'



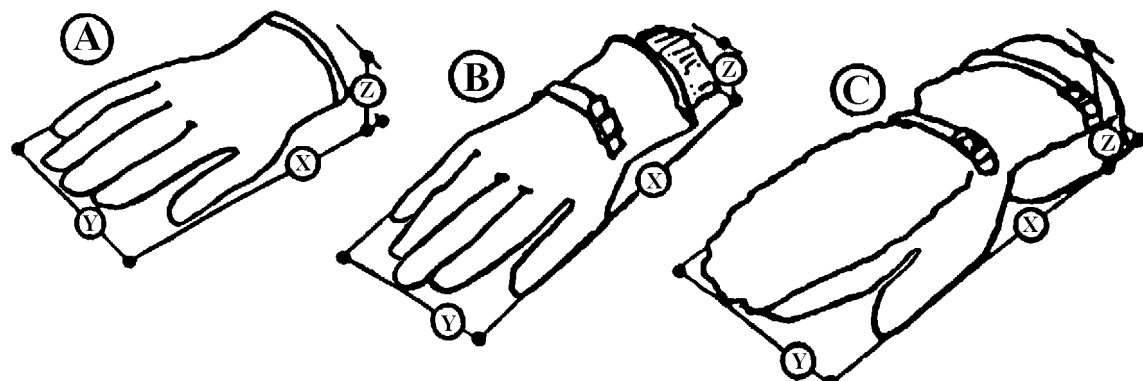
tasks. The effects on the extremes of the population distribution shall be determined.

**Discussion.** Nude dimension and light clothing can be regarded as synonymous for practical purposes. Additional information on the changes in anthropometric measurement values imposed by different clothing ensembles are found in Johnson, 1984.

**Exhibit 14.1.4.7** Additive effects of clothing on anthropometric measures

	Light clothing	Medium clothing	Heavy clothing
Abdomen depth	2.39 cm (0.94 in)	3.00 cm (1.18 in)	6.45 cm (2.54 in)
Buttock-knee length	0.51 cm (0.20 in)	0.76 cm (0.30 in)	1.78 cm (0.70 in)
Chest depth	1.04 cm (0.41 in)	2.44 cm (0.96 in)	3.91 cm (1.54 in)
Elbow breadth	1.42 cm (0.56 in)	2.64 cm (1.04 in)	5.38 cm (2.12 in)
Hip breadth	1.42 cm (0.56 in)	1.93 cm (0.76 in)	3.56 cm (1.40 in)
Hip breadth, sitting	1.42 cm (0.56 in)	1.93 cm (0.76 in)	3.56 cm (1.40 in)
Knee breadth (both)	1.22 cm (0.48 in)	1.22 cm (0.48 in)	4.27 cm (1.68 in)
Knee height, sitting	3.35 cm (1.32 in)	3.35 cm (1.32 in)	3.66 cm (1.44 in)
Shoulder breadth	0.61 cm (0.24 in)	2.24 cm (0.88 in)	2.95 cm (1.16 in)
Shoulder-elbow length	0.36 cm (0.14 in)	1.27 cm (0.50 in)	1.57 cm (0.62 in)
Shoulder height, sitting	0.41 cm (0.16 in)	1.47 cm (0.58 in)	2.03 cm (0.80 in)

Exhibit 14.1.4.7 (continued) Additive effects of clothing on anthropometric measures



Hand position	A Anti-contact glove			B Wet-cold glove			C Arctic glove		
	X	Y	Z	X	Y	Z	X	Y	Z
Extended flat	cm 26.7 (in) (10.5)	11.9 (4.7)	6.4 (2.5)	27.2 (10.7)	14.5 (5.7)	7.6 (3.0)	42.2 (16.6)	13.7 (5.4)	9.1 (3.6)
Closed as fist	cm 17.8 (in) (7.0)	12.7 (5.0)	8.4 (3.3)	18.5 (7.3)	14.7 (5.8)	9.4 (3.7)	36.3 (14.3)	13.2 (5.2)	13.7 (5.4)
Grasping handle									
0.6 cm (0.24 in) diameter	17.8 (7.0)	12.7 (5.0)	8.9 (3.5)	18.5 (7.3)	14.0 (5.5)	8.9 (3.5)	35.6 (14.0)	14.0 (5.5)	11.4 (4.5)
2.5 cm (1.0 in) diameter	17.8 (7.0)	12.7 (5.0)	8.9 (3.5)	18.5 (7.3)	13.5 (5.3)	10.2 (4.0)	35.6 (14.0)	13.2 (5.2)	11.4 (4.5)
5.0 cm (2.0 in) diameter	19.0 (7.5)	11.4 (4.5)	10.7 (4.2)	20.3 (8.0)	11.9 (4.7)	10.2 (4.0)	38.1 (15.0)	13.7 (5.4)	12.7 (5.0)
Grasping knob									
0.6 cm (0.24 in) diameter	20.3 (8.0)	9.7 (3.8)	10.9 (4.3)	22.9 (9.0)	11.7 (4.6)	10.2 (4.0)	39.4 (15.5)	12.2 (4.8)	11.4 (4.5)
2.5 cm (1.0 in) diameter	22.8 (9.0)	8.9 (3.5)	10.2 (4.0)	22.9 (9.0)	11.4 (4.5)	10.2 (4.0)	40.1 (15.8)	12.2 (4.8)	12.2 (4.8)
5.0 cm (2.0 in) diameter	24.1 (9.5)	9.4 (3.7)	9.4 (3.7)	23.4 (9.2)	11.4 (4.5)	10.7 (4.1)	40.5 (15.9)	11.9 (4.7)	12.2 (4.8)

### 14.1.5 Use of distribution and correlation data

- **14.1.4.8 Effects of tools and equipment lifted or carried.** If tools or equipment are to be lifted or carried, the additive effects of their dimensions upon the relevant human characteristics and measures shall be determined by taking into account:
  - a. how the tool or equipment may be lifted and carried,
  - b. the number of people involved in the carry or in the lift,
  - c. the tasks involving the tools or equipment, and
  - d. the effects on work passageways, areas, and stations.

Complex uses of statistical data concerning human physical dimensions or capabilities are introduced in this section. Data and distribution information on a single physical characteristic and its measures provides no information about that characteristic's composite relationship with any other characteristic and its measures. For design, the relationship between two or more characteristics and how their measures vary together is important. Consider sizing clothing and designing seats. Bivariate distributions and correlation statistics can be used by knowledgeable professionals to determine design criteria.

- **14.1.5.1 Gaussian distribution of measurement values on a single human physical characteristic.** The relationship between the Gaussian distribution and the measurement value equivalent to the desired percentile statistic value should best be determined from a smoothed frequency distribution or from the formula presented in exhibit 14.1.5.1 if the following conditions are met:
  - a. the percentile value is not given in applicable Human-machine-interface data, and
  - b. the population distribution for the applicable human physical characteristic is known to be Gaussian (normal) and the mean and variance are known.

**Exhibit 14.1.5.1 Percentile values**

Percentile		Formula*
+	-	(SD)
70	and 30 %tile =	$X \pm (0.524)(X)$
75	and 25 %tile =	$X \pm (0.674)(X)$
80	and 20 %tile =	$X \pm (0.842)(X)$
85	and 15 %tile =	$X \pm (1.036)(X)$
90	and 10 %tile =	$X \pm (1.282)(X)$
95	and 5 %tile =	$X \pm (1.645)(X)$
97.5	and 2.5 %tile =	$X \pm (1.960)(X)$
99	and 1 %tile =	$X \pm (2.326)(X)$
99.5	and 0.5 %tile =	$X \pm (2.576)(X)$

SD = (Standard deviation) X = mean or 50th percentile  
 \* Do not use with skewed strength data.

- **14.1.5.2 Using bivariate distribution data.** Bivariate data should be professionally applied and interpreted since knowledge of the population distribution characteristics are necessary to project and extract design limits and to apply them to design problems.

**Discussion.** The variability of two body measurements and their interrelationship with each other may be presented in a graph or a table. Bivariate information includes the ranges of two measurements and the percentages or frequencies of individuals who are characterized by the various possible combinations of values of the two measurements. Knowledgeable professionals can tell about the relationships from the appearance and shape of the joint distribution of measures. Correlation statistics, when the relationship warrants, provides additional insight and when an appropriate samples are large enough may provide predictions of population values.

- **14.1.5.3 Use of correlation and multiple correlation data.** If two or more human physical characteristics are applicable to a design problem, professionals should apply and interpret correlation statistics. Knowledge about distributions and intercorrelations among the distributions need to be factored into the use of these data.

**Discussion.** The relationships or correlations between specific body measurements are highly variable among the various human characteristics and may differ across samples and populations. For example, breadth measurements tend to be more highly correlated with weight than with stature. The degree of the relationship may be expressed by a correlation coefficient or "r" value.

Although common percentile values may not be used to sum data across adjacent body parts, (see paragraph 14.1.3.3), regression equations derived from the applicable samples can be used in constructing composite body measures.

**Definition.** The **correlation coefficient or "r" value** describes the degree to which two variables vary together (positive correlation) or vary inversely (negative correlation). The correlation coefficient, "r", has a range of values from +1.0 (perfect positive correlation) through -1.0 (perfect negative correlation). Multiple correlation involves the predictable relationship of two or more variables with another criterion variable (such as a composite measurement value). **"R"** is the **multiple correlation coefficient**. It is recommended that only correlations with strong predictive values be used (that is where r or R is at least or greater than |.7|). (Note:  $R^2$  is

the square of the multiple correlation coefficient and equates to the proportion of the variation accounted for in the prediction. An R of .7 would account for about 50 percent of the variation).

### 14.1.6 Use of models

Models that represent human physical characteristics are being used with increasing frequency in the design of equipment and systems. Some models are as simple as drawing board manikins with articulated joint movement. Others use computer graphics to model dynamic human physical characteristics in three dimensional workplaces. Other models are being developed to integrate human physical characteristics into computer-aided design software.

- **14.1.6.1 Data applicable to the design problem.** Designers and human factors specialists shall ensure that models of human physical characteristics contain and appropriately use accurate population, sample, or guideline-based data for the user population and the design problem of interest.
- **14.1.6.2 Common errors.** Designers and human factors specialists shall ensure that neither the model to be used nor the manner of its use violates the design criteria about common anthropometric pitfalls stated in section 14.1.3.
- **14.1.6.3 Use of design limits approach.** Designers and human factors specialists shall ensure that models employed in design appropriately use the design limits method.
- **14.1.6.4 Model treatment of multiple variables.** If multivariate treatments are appropriate to a design problem, designers and human factors specialists shall ensure that the models appropriately treat and use the proper multivariate data.
- **14.1.6.5 Joint mobility and reach interaction.** Designers and human factors specialists shall ensure that the models appropriately treat joint mobility and reach (see subsections 14.3.3.2 and 14.4).

## 14.2 Anthropometric variability factors

There are many factors that relate to the large variability observed in measures of the human body. These factors include: (1) body position, (2) age, health, and body condition, (3) sex, (4) race and national origin, (5) occupation, and (6) evolutionary trends. These factors affect future population sampling and encourage the use of the most recent data on the populations of interest. If designers and human factors specialists need to draw upon other data or accomplish some special purpose sampling, the following guidelines related to data variability may assist.

- **14.2.1 Foreign populations.** If a specific use of the system or equipment involves operation or maintenance by foreign personnel in locations outside the United States, sample data should be obtained that represents the foreign work force.
- **14.2.2 Race.** There are no practical differences between the anthropometric characteristics of the U.S. Afro-American

population and the U.S. population as a whole. Thus no special data collections or data adjustment should be used to accommodate the integrated U.S. work population.

- **14.2.3 Body slump.** In determining body position and eye position zones for seated or standing positions, a slump factor which accompanies relaxation should be taken into account. Seated-eye height measurements can be reduced by as much as 65 mm (2.56 in) when a person sits in a relaxed position. Body slump, when standing, reduces stature as much as 19 mm (.75 in) from a perfectly erect position. These slump factors should be considered in designing adjustable seats, visual envelopes, and display locations.

## 14.3 Anthropometric and biomechanics data

This section provides general guidance for the use of specific anthropometric and biomechanics data, static body characteristics data, dynamic body characteristic data including range of joint motion and common and mobile working positions.

Dimensions of the human body which influence the design of personal and operational equipment are of two types: (1) static dimensions, which are measurements of the head, torso, and limbs in normal positions, and (2) dynamic dimensions, which are measurements taken in working positions or during movement.

### 14.3.1 Data usage

- **14.3.1.1 Use of anthropometric and biomechanics data.** Data throughout section 14.3 are to be used for anthropometric issues that are not addressed in earlier sections of this HFDG. If designers and human factors specialists need additional data to solve anthropometric design problems associated with human physical characteristics they shall use the data presented in DoD-HDBK-743 (see also 14.1.1.2).
- **14.3.1.2 Task considerations.** Designers and human factors specialists shall take the following task conditions into consideration when using the human physical characteristic data presented in this section:
  - a. the nature, frequency, and difficulty of the related tasks to be performed by the operator or maintainer of the equipment,
  - b. the position of the body during performance of operations and maintenance tasks,
  - c. mobility and flexibility demands imposed by maintenance tasks,
  - d. the touch, grasp, torque, lift, and carry requirements of the tasks,

- e. increments in the design-critical dimensions imposed by clothing or equipment, packages, and tools, and
- f. increments in the design-critical dimensions imposed by the need to compensate for obstacles and projections.

### 14.3.2 Static body characteristics

- **14.3.2.1 Static data.** Exhibit 14.3.2.1 presents static human physical characteristics and measurement values which should be used, as applicable, in design problems. Exhibit 14.3.2.1 addresses the following body parts: head, seated body, standing body, and hands.
- **14.3.2.2 Relevant static anthropometric data.** If applicable, designers and human factors specialists shall use the relevant anthropometric design criteria and guidelines from this guide associated with:
  - a. hand and finger access in section 6 (see paragraphs 6.4.3.2, 6.4.3.3, and 6.4.3.4),
  - b. handle features for lifting and carrying in section 6 (see sections 6.2.5.2 and 6.2.5.3),
  - c. spacing between controls in section 7 (see paragraphs 7.4.3.1, 7.4.4.10.1, and 7.4.4.11.1), and
  - d. common working positions in section 9 (see paragraph 9.4.1).

Exhibit 14.3.2.1 Static human physical characteristics (head)

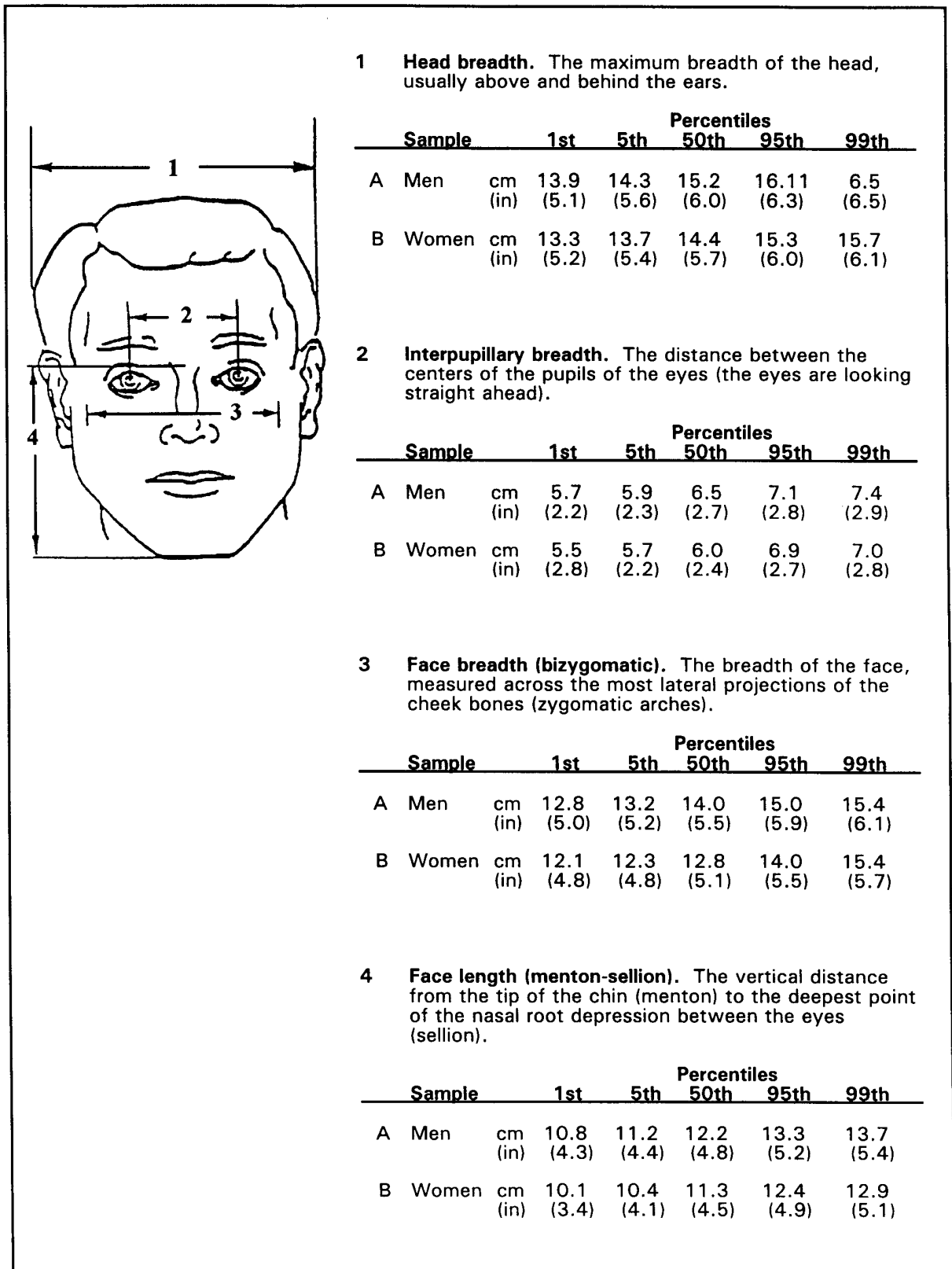
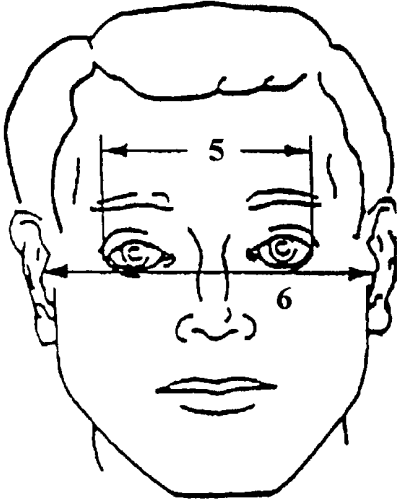





Exhibit 14.3.2.1 (continued) Static human physical characteristics (head)



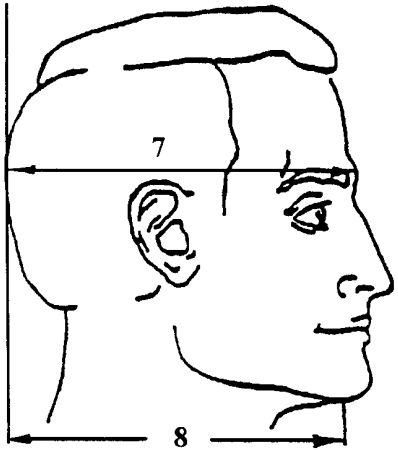
**5 Biocular breadth.** The distance from the outer corners of the eyes (right and left ectocanthi).

Sample		Percentiles				
		1st	5th	50th	95th	99th
A Men	cm	11.0	11.3	12.2	13.1	13.6
	(in)	(4.3)	(4.5)	(4.8)	(5.2)	(5.4)
B Women	cm	10.8	11.1	11.6	12.9	13.3
	(in)	(4.3)	(4.4)	(4.3)	(5.1)	(5.3)




**6 Bitragion breadth.** The breadth of the head from the right tragon to the left. (Tragion is the cartilaginous notch at the front of the ear).

Sample		Percentiles				
		1st	5th	50th	95th	99th
A Men	cm	13.1	13.5	14.5	15.5	15.9
	(in)	(5.2)	(5.3)	(5.7)	(6.1)	(6.3)
B Women	cm	12.5	12.8	13.3	14.3	15.0
	(in)	(4.3)	(5.4)	(5.4)	(5.7)	(5.9)



**7 Glabella to back of head.** The horizontal distance from the most anterior point of the forehead between the brow-ridges (glabella) to the back of the head, measured with a headboard.

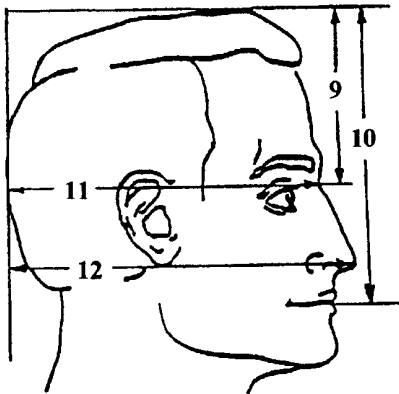
Sample		Percentiles				
		1st	5th	50th	95th	99th
A Men	cm	18.3	18.8	20.0	21.1	21.7
	(in)	(7.2)	(7.4)	(7.9)	(8.3)	(8.5)
B Women	cm	17.5	18.0	19.1	20.2	20.7
	(in)	(6.9)	(7.1)	(7.5)	(8.0)	(8.1)



**8 Menton to back of head.** The horizontal distance from the tip of the chin (menton) to the back of the head, measured with a headboard.

Sample		Percentiles				
		1st	5th	50th	95th	99th
A Men	cm	15.7	16.5	18.2	20.0	20.7
	(in)	(6.2)	(6.5)	(7.2)	(7.9)	(8.2)
B Women	cm	15.2	15.8	17.3	18.9	19.6
	(in)	(6.0)	(6.2)	(6.8)	(7.4)	(7.7)

Exhibit 14.3.2.1 (continued) Static human physical characteristics (head)



**9 Sellion to top of head.** The vertical distance from the nasal root depression between the eyes (sellion), to the level of the top of the head, measured with a headboard.

Sample			Percentiles				
			1st	5th	50th	95th	99th
A	Men	cm (in)	9.7 (3.8)	10.1 (4.0)	11.2 (4.4)	12.4 (4.9)	12.9 (5.1)
B	Women	cm (in)	9.0 (3.5)	9.5 (3.7)	10.5 (4.1)	11.7 (4.6)	12.2 (4.8)

**10 Stomion to top of head.** The vertical distance from the midpoint of the lips (stomion) to the level of the top of the head, measured with a headboard.

Sample			Percentiles				
			1st	5th	50th	95th	99th
A	Men	cm (in)	16.9 (6.7)	17.4 (6.8)	18.6 (7.3)	19.9 (7.8)	20.6 (8.1)
B	Women	cm (in)	15.7 (6.2)	16.3 (6.4)	17.5 (6.9)	18.8 (7.4)	19.4 (7.7)

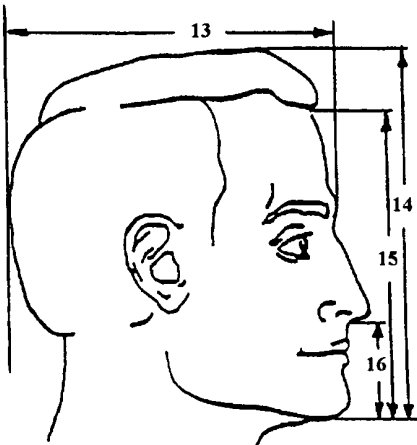
**11 Sellion to back of head.** The horizontal distance from the nasal root depression between the eyes (sellion), to the back of the head, measured with a headboard.

Sample			Percentiles				
			1st	5th	50th	95th	99th
A	Men	cm (in)	18.0 (7.1)	18.5 (7.3)	19.7 (7.8)	20.9 (8.2)	21.4 (8.4)
B	Women	cm (in)	17.4 (6.8)	17.8 (7.0)	18.9 (7.4)	20.0 (7.9)	20.5 (8.1)

**12 Pronasale to back of head.** The horizontal distance from the tip of the nose (pronasale) to the back of the head, measured with a headboard.

Sample			Percentiles				
			1st	5th	50th	95th	99th
A	Men	cm (in)	20.0 (7.9)	20.5 (8.1)	22.0 (8.7)	23.2 (9.1)	23.9 (9.4)
B	Women	cm (in)	19.2 (7.6)	19.7 (7.8)	21.0 (8.3)	22.2 (8.7)	22.8 (9.0)

Exhibit 14.3.2.1 (continued) Static human physical characteristics (head)



**13 Head length.** The maximum length of the head; measured from the most anterior point of the forehead between the brow-ridges (glabella) to the back of the head (occiput).

Sample			Percentiles				
			1st	5th	50th	95th	99th
A	Men	cm (in)	18.0 (7.1)	18.5 (7.3)	19.7 (7.8)	20.9 (8.2)	21.3 (8.4)
B	Women	cm (in)	17.2 (6.8)	17.6 (7.0)	18.7 (7.4)	19.8 (7.8)	20.2 (8.0)

**14 Menton to top of head.** The vertical distance from the tip of the chin (menton) to the level of the top of the head, measured with a headboard.

Sample			Percentiles				
			1st	5th	50th	95th	99th
A	Men	cm (in)	21.2 (8.4)	21.8 (8.6)	23.2 (8.6)	24.7 (9.1)	25.5 (9.4)
B	Women	cm (in)	19.8 (7.8)	20.4 (8.3)	21.8 (8.6)	23.2 (9.1)	23.8 (9.4)

**15 Menton-crinion length.** The vertical distance from the bottom of the chin (menton) to the midpoint of the hairline (crinion).

Sample			Percentiles				
			1st	5th	50th	95th	99th
A	Men	cm (in)	16.6 (6.5)	17.4 (6.9)	19.1 (7.5)	20.9 (8.2)	21.6 (8.5)
B	Women	cm (in)	15.5 (6.1)	16.1 (6.3)	17.7 (7.0)	19.2 (7.6)	19.9 (7.8)

**16 Menton-subnasale length.** The distance from the bottom of the chin (menton) to the base of the nasal septum (subnasale).

Sample			Percentiles				
			1st	5th	50th	95th	99th
A	Men	cm (in)	6.1 (2.4)	6.5 (2.7)	7.3 (2.9)	8.3 (3.3)	8.7 (3.3)
B	Women	cm (in)	5.7 (2.2)	6.0 (2.4)	6.5 (2.7)	7.8 (3.1)	8.3 (3.8)

Exhibit 14.3.2.1 (continued) Static human physical characteristics (seated)

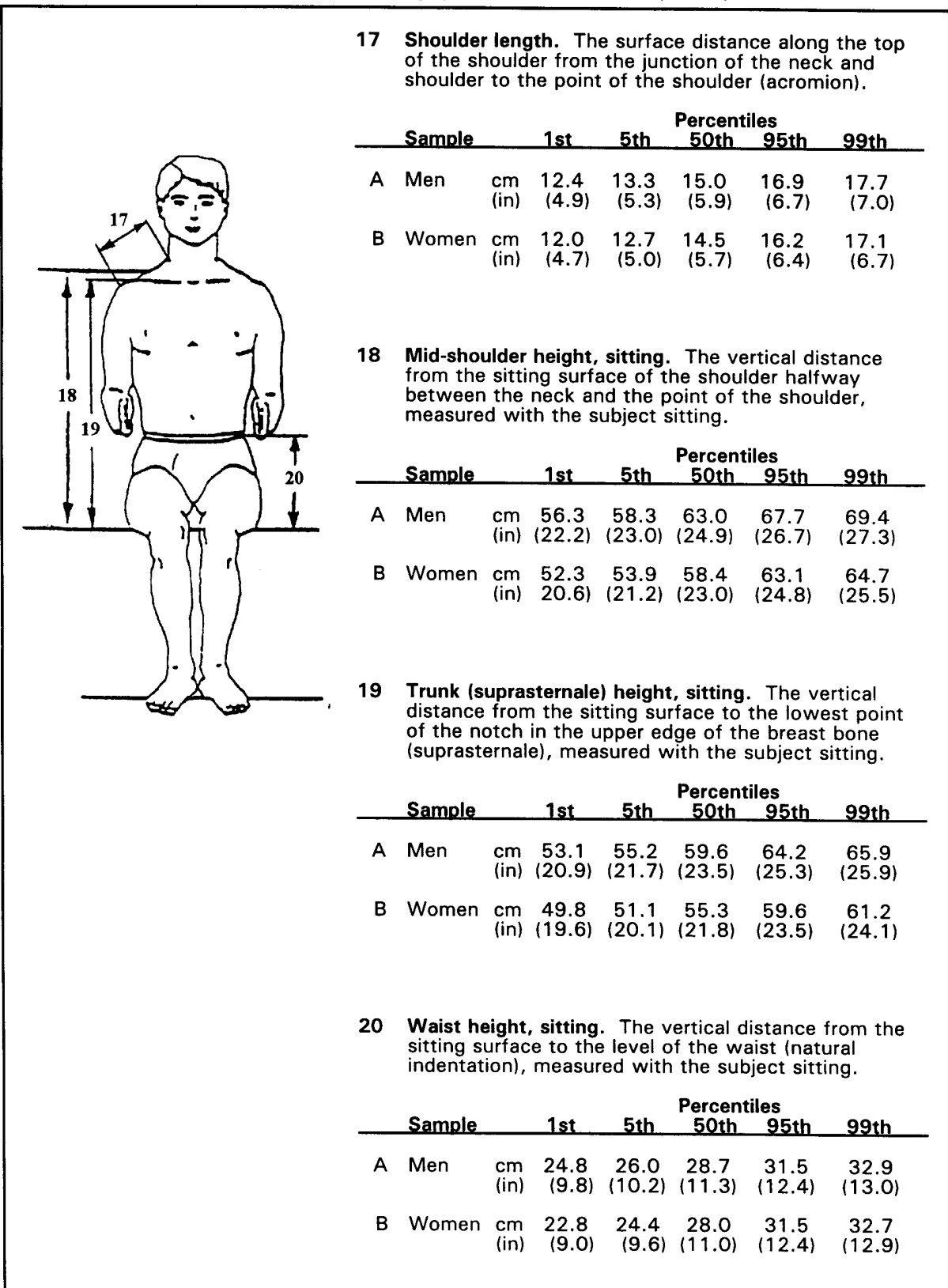
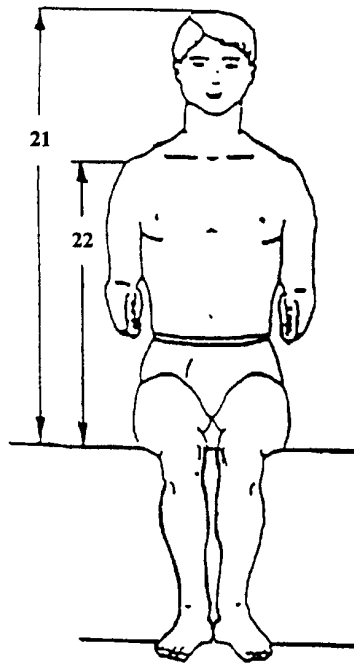


Exhibit 14.3.2.1 (continued) Static human physical characteristics (seated)

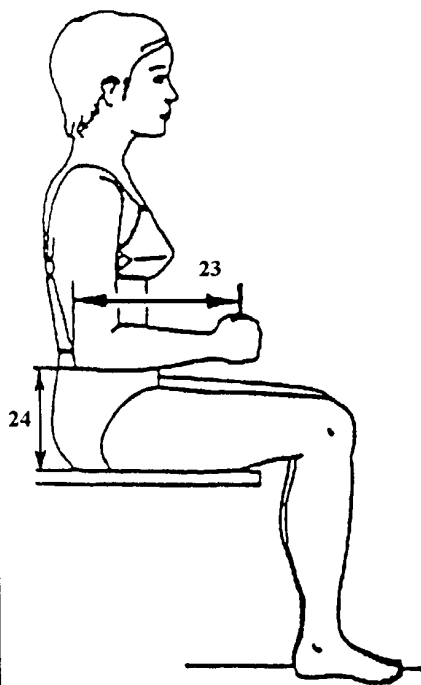


**21 Sitting height.** The vertical distance from the sitting surface to the top of the head, measured with the subject sitting.

Sample		Percentiles				
		1st	5th	50th	95th	99th
A	Men	cm 82.8 (in) (32.6)	85.5 (33.7)	91.4 (36.0)	97.2 (38.3)	99.1 (39.0)
B	Women	cm 77.5 (in) (30.5)	79.5 (31.3)	85.1 (33.5)	91.0 (35.8)	93.3 (36.7)

**22 Shoulder (acromiale) height, sitting.** The vertical distance from the sitting surface to the point of the shoulder (acromion), measured with the subject sitting.

Sample		Percentiles				
		1st	5th	50th	95th	99th
A	Men	cm 129.9 (in) (51.1)	134.2 (52.8)	144.2 (56.8)	154.6 (60.1)	158.4 (62.4)
B	Women	cm 120.4 (in) (47.4)	123.9 (48.8)	133.3 (52.5)	143.7 (56.6)	147.5 (58.1)



**23 Elbow-grip length.** The horizontal distance from the back of the elbow to the center of the clenched fist.

Sample		Percentiles				
		1st	5th	50th	95th	99th
A	Men	cm 32.3 (in) (12.7)	33.2 (13.1)	35.9 (14.1)	39.1 (15.4)	40.3 (15.9)
B	Women	cm 28.9 (in) (11.4)	30.0 (11.8)	32.8 (12.9)	35.8 (14.1)	37.2 (14.7)

**24 Elbow rest height.** The vertical distance from the sitting surface to the bottom of the tip of the elbow, measured with the subject sitting and the forearm held horizontally.

Sample		Percentiles				
		1st	5th	50th	95th	99th
A	Men	cm 16.8 (in) (6.6)	18.4 (7.2)	23.2 (9.1)	27.4 (10.8)	29.2 (11.5)
B	Women	cm 15.8 (in) (6.2)	17.6 (6.9)	22.1 (8.7)	26.4 (10.4)	28.2 (11.1)

Exhibit 14.3.2.1 (continued) Static human physical characteristics (seated)

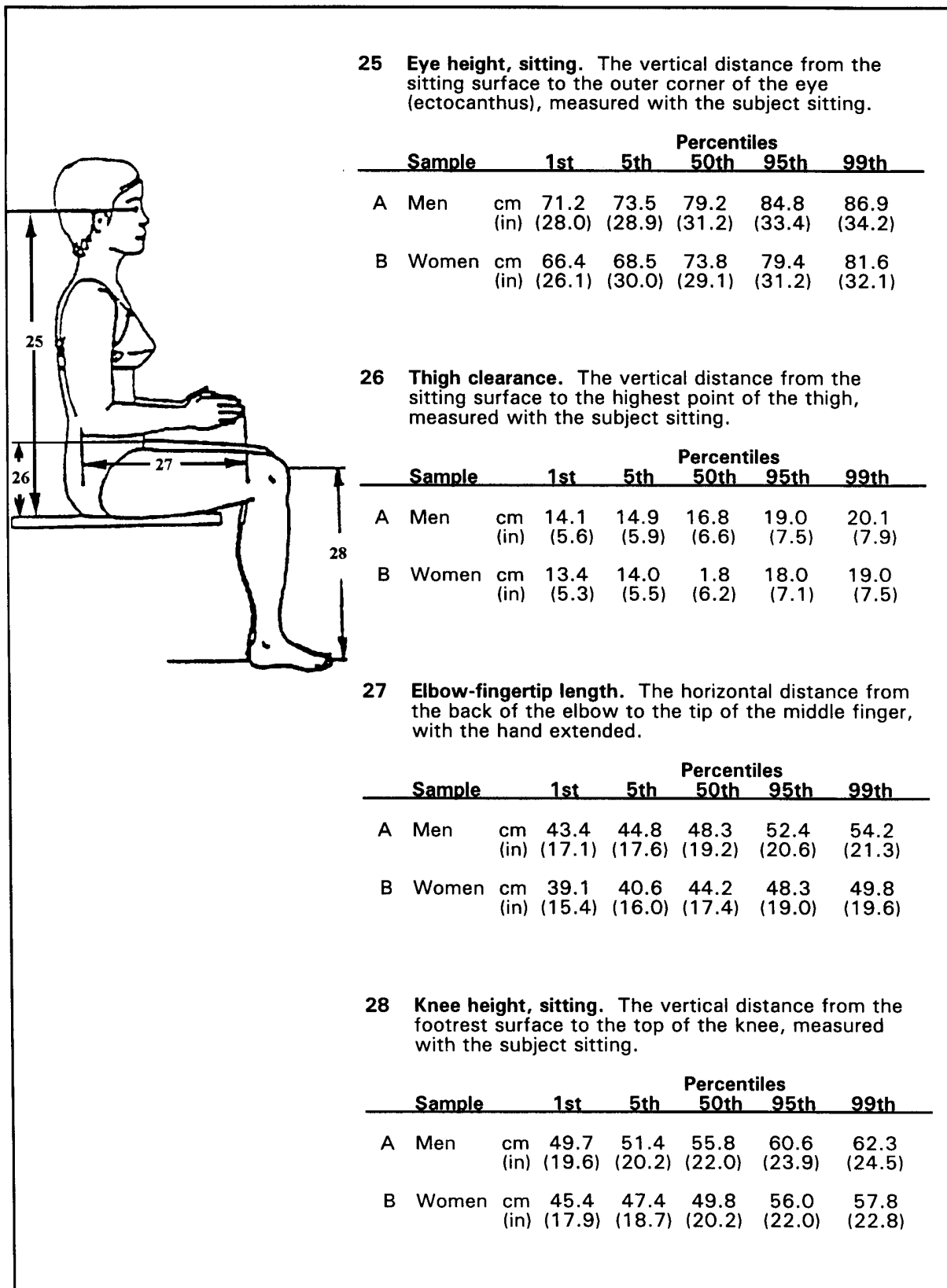
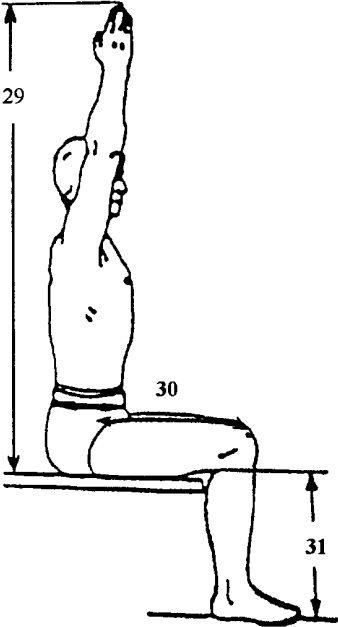
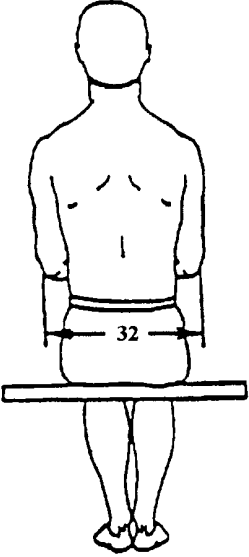


Exhibit 14.3.2.1 (continued) Static human physical characteristics (seated)



**29 Vertical reach, sitting.** The vertical distance from the sitting surface to the tip of the middle finger, measured with the subject sitting and the arm, hand, and fingers extended vertically.

Sample		Percentiles				
		1st	5th	50th	95th	99th
A	Men	cm 129.3 (in) (50.1)	133.8 (52.7)	143.3 (56.4)	153.2 (60.3)	156.7 (61.7)
B	Women	cm 119.7 (in) (47.1)	123.3 (48.5)	132.7 (52.2)	141.8 (55.8)	145.4 (57.2)



**30 Abdominal depth, sitting.** The depth of the abdomen, with the subject sitting.

Sample		Percentiles				
		1st	5th	50th	95th	99th
A	Men	cm 18.6 (in) (7.3)	19.9 (7.8)	23.6 (9.3)	29.1 (11.5)	31.4 (12.4)
B	Women	cm 17.3 (in) (6.1)	18.5 (7.3)	21.9 (8.6)	27.1 (10.7)	29.5 (11.6)

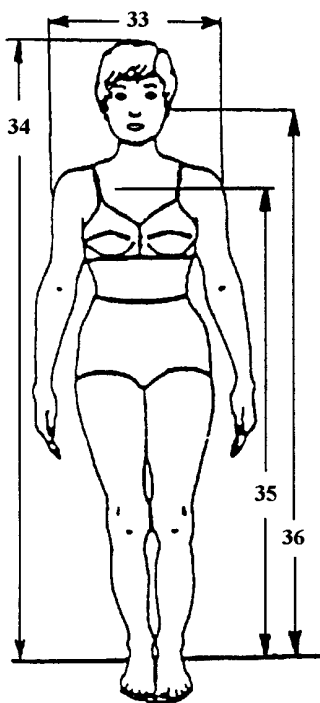
**31 Popliteal height, sitting.** The vertical distance from the footrest surface to the underside of the lower leg, measured with the subject sitting.

Sample		Percentiles				
		1st	5th	50th	95th	99th
A	Men	cm 37.8 (in) (14.9)	39.5 (15.6)	43.3 (17.1)	47.6 (18.7)	49.5 (19.5)
B	Women	cm 33.7 (in) (13.3)	35.1 (13.8)	38.9 (15.3)	42.9 (16.9)	44.6 (17.6)

**32 Forearm-forearm breadth, sitting.** The horizontal distance across the body between the outer surfaces of the forearms, measured with the forearms flexed and held against the body.

Sample		Percentiles				
		1st	5th	50th	95th	99th
A	Men	cm 45.1 (in) (17.8)	47.79 (18.8)	54.5 (21.5)	62.1 (24.5)	65.3 (25.7)
B	Women	cm 39.4 (in) (15.5)	41.5 (16.3)	46.7 (18.4)	52.8 (20.8)	56.0 (22.1)

Exhibit 14.3.2.1 (continued) Static human physical characteristics (standing)



**33 Shoulder (bideltoïd) breadth.** The horizontal distance across the upper arms between the maximum bulges of the deltoïd muscles; the arms are hanging and relaxed.

Sample		Percentiles				
		1st	5th	50th	95th	99th
A Men	cm	43.4	45.0	49.1	53.5	55.2
	(in)	(17.1)	(17.7)	(19.3)	(21.1)	(21.7)
B Women	cm	38.0	39.7	43.1	47.2	49.2
	(in)	(15.0)	(15.6)	(17.0)	(18.6)	(19.4)

**34 Stature.** The vertical distance from the floor to the top of the head.

Sample		Percentiles				
		1st	5th	50th	95th	99th
A Men	cm	160.3	164.7	175.5	186.7	190.9
	(in)	(63.1)	(64.8)	(69.1)	(73.5)	(75.2)
B Women	cm	148.3	152.8	162.7	173.7	178.0
	(in)	(58.4)	(60.2)	(64.1)	(68.4)	(70.1)

**35 Suprasternale height.** The vertical distance from the floor to the lowest point of the notch in the upper edge of the breast bone (suprasternale).

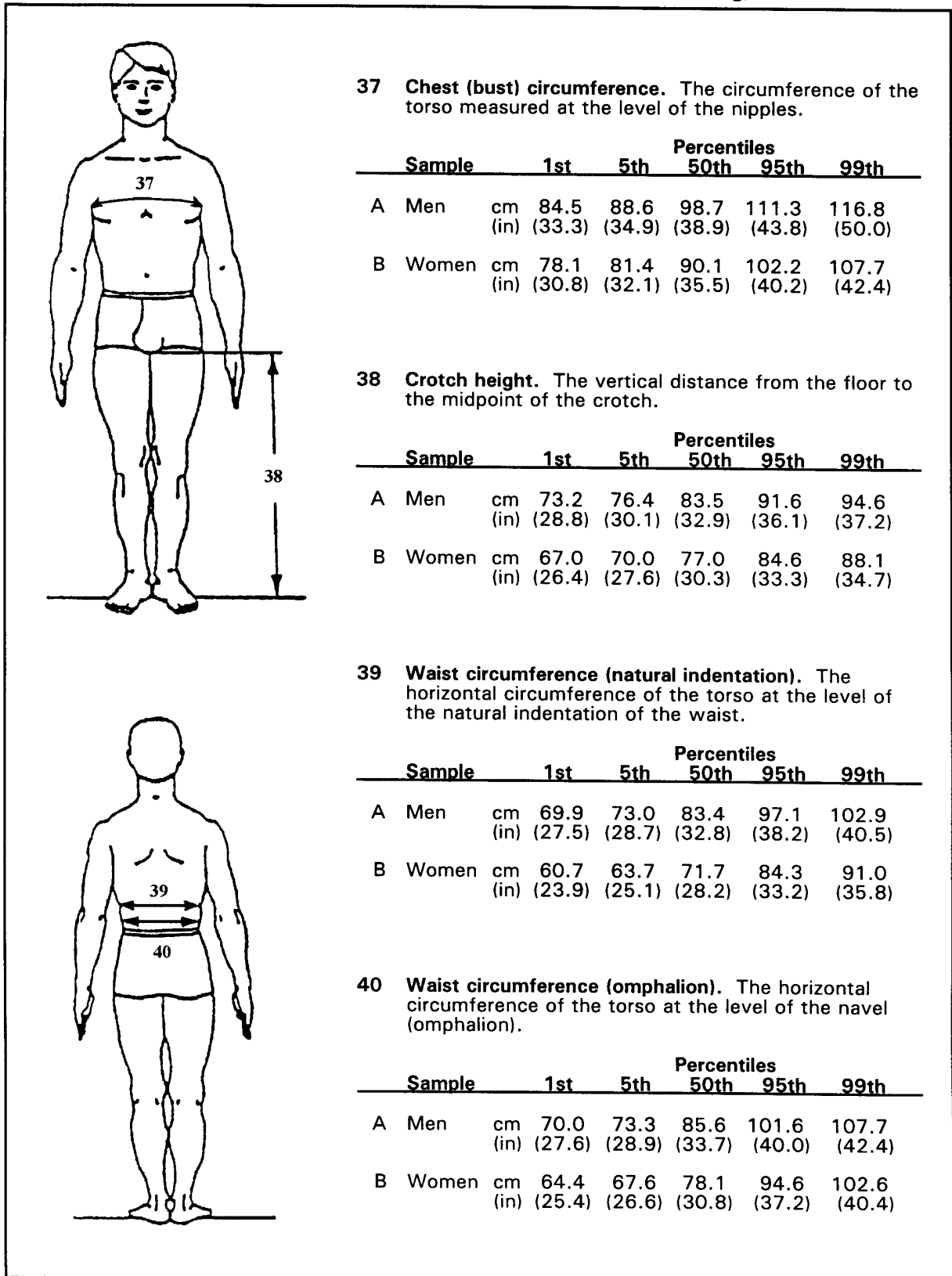
Sample		Percentiles				
		1st	5th	50th	95th	99th
A Men	cm	130.2	134.3	143.7	153.7	157.5
	(in)	51.3	(52.9)	(56.6)	(60.5)	(62.0)
B Women	cm	120.7	124.1	132.9	142.5	146.4
	(in)	(47.5)	(48.9)	(52.3)	(56.1)	(57.6)

**36 Tragion height, standing.** The vertical distance from the floor to the tragion, the cartilaginous notch at the front of the ear.

Sample		Percentiles				
		1st	5th	50th	95th	99th
A Men	cm	147.4	151.9	162.4	173.4	177.5
	(in)	(58.0)	(59.8)	(63.9)	(68.3)	(69.9)
B Women	cm	136.3	140.7	150.4	161.2	165.4
	(in)	(53.7)	(55.4)	(59.2)	(63.5)	(65.1)



Exhibit 14.3.2.1 (continued) Static human physical characteristics (standing)



**37 Chest (bust) circumference.** The circumference of the torso measured at the level of the nipples.

Sample		1st	5th	Percentiles		
				50th	95th	99th
A	Men	cm 84.5 (in) (33.3)	88.6 (34.9)	98.7 (38.9)	111.3 (43.8)	116.8 (50.0)
B	Women	cm 78.1 (in) (30.8)	81.4 (32.1)	90.1 (35.5)	102.2 (40.2)	107.7 (42.4)

**38 Crotch height.** The vertical distance from the floor to the midpoint of the crotch.

Sample		1st	5th	Percentiles		
				50th	95th	99th
A	Men	cm 73.2 (in) (28.8)	76.4 (30.1)	83.5 (32.9)	91.6 (36.1)	94.6 (37.2)
B	Women	cm 67.0 (in) (26.4)	70.0 (27.6)	77.0 (30.3)	84.6 (33.3)	88.1 (34.7)

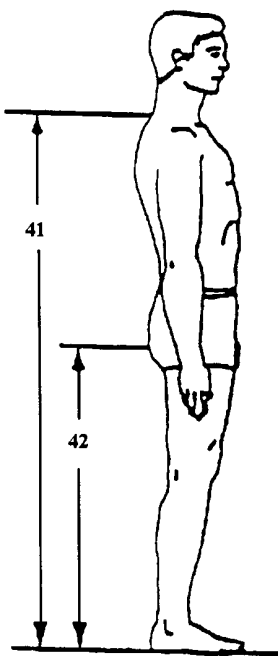
**39 Waist circumference (natural indentation).** The horizontal circumference of the torso at the level of the natural indentation of the waist.

Sample		1st	5th	Percentiles		
				50th	95th	99th
A	Men	cm 69.9 (in) (27.5)	73.0 (28.7)	83.4 (32.8)	97.1 (38.2)	102.9 (40.5)
B	Women	cm 60.7 (in) (23.9)	63.7 (25.1)	71.7 (28.2)	84.3 (33.2)	91.0 (35.8)

**40 Waist circumference (omphalion).** The horizontal circumference of the torso at the level of the navel (omphalion).

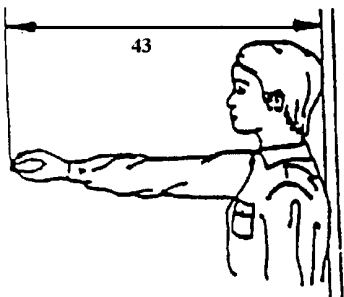
Sample		1st	5th	Percentiles		
				50th	95th	99th
A	Men	cm 70.0 (in) (27.6)	73.3 (28.9)	85.6 (33.7)	101.6 (40.0)	107.7 (42.4)
B	Women	cm 64.4 (in) (25.4)	67.6 (26.6)	78.1 (30.8)	94.6 (37.2)	102.6 (40.4)

Exhibit 14.3.2.1 (continued) Static human physical characteristics (standing)



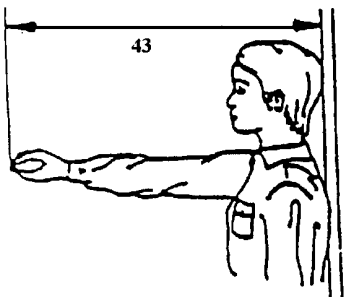
**41 Cervicale height.** The vertical distance from the floor to the cervicale, the tip of the spine of the seventh cervical vertebra at the base of the neck.

Sample		Percentiles				
		1st	5th	50th	95th	99th
A	Men	cm 137.4 (in) (54.1)	141.8 (55.8)	151.8 (59.8)	162.4 (63.9)	166.1 (65.4)
B	Women	cm 127.3 (in) (50.1)	131.4 (51.7)	140.6 (55.4)	150.8 (59.4)	154.8 (60.9)



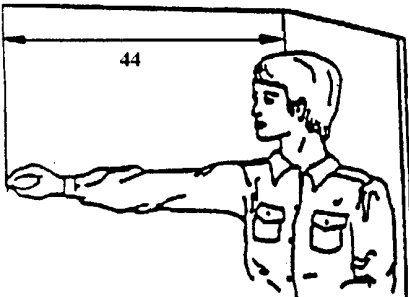
**42 Buttock height.** The vertical distance from the floor to the maximum posterior protrusion of the buttock.

Sample		Percentiles				
		1st	5th	50th	95th	99th
A	Men	cm 78.4 (in) (30.9)	81.5 (32.1)	88.5 (34.8)	96.9 (38.1)	100.5 (39.6)
B	Women	cm 73.9 (in) (29.1)	76.7 (30.2)	83.7 (33.0)	91.5 (36.0)	94.9 (37.4)



**43 Functional (thumb-tip) reach.** The horizontal distance from the wall to the tip of the thumb, measured with the subject's shoulders against the wall, the arm extended forward, and the index finger touching the tip of the thumb.

Sample		Percentiles				
		1st	5th	50th	95th	99th
A	Men	cm 72.0 (in) (28.4)	73.9 (29.1)	80.0 (31.5)	86.7 (34.1)	89.7 (35.3)
B	Women	cm 65.8 (in) (25.9)	67.7 (26.7)	73.4 (28.9)	79.7 (31.4)	82.4 (32.4)



**44 Functional (thumb-tip) reach, extended.** Measured similarly to functional (thumb-tip) reach, except that the right shoulder is extended forward as far as possible, while the left shoulder is kept pressed firmly against the wall.

Sample		Percentiles				
		1st	5th	50th	95th	99th
A	Men	cm 77.9 (in) (30.7)	80.5 (31.7)	87.3 (34.4)	94.2 (37.1)	97.7 (38.5)
B	Women	cm 71.2 (in) (28.0)	73.5 (28.9)	79.6 (31.3)	86.2 (33.9)	89.0 (35.0)

Exhibit 14.3.2.1 (continued) Static human physical characteristics (hands)

**45 Hand breadth.** The breadth of the hand, measured across the ends of the metacarpal bones (metacarpal-phalangeal joints).

Sample		Percentiles				
		1st	5th	50th	95th	99th
A Men	cm (in)	8.1 (3.2)	8.4 (3.3)	9.0 (3.5)	9.8 (3.9)	10.0 (3.9)
B Women	cm (in)	7.1 (2.8)	7.3 (2.9)	7.9 (3.1)	8.6 (3.4)	8.9 (3.5)

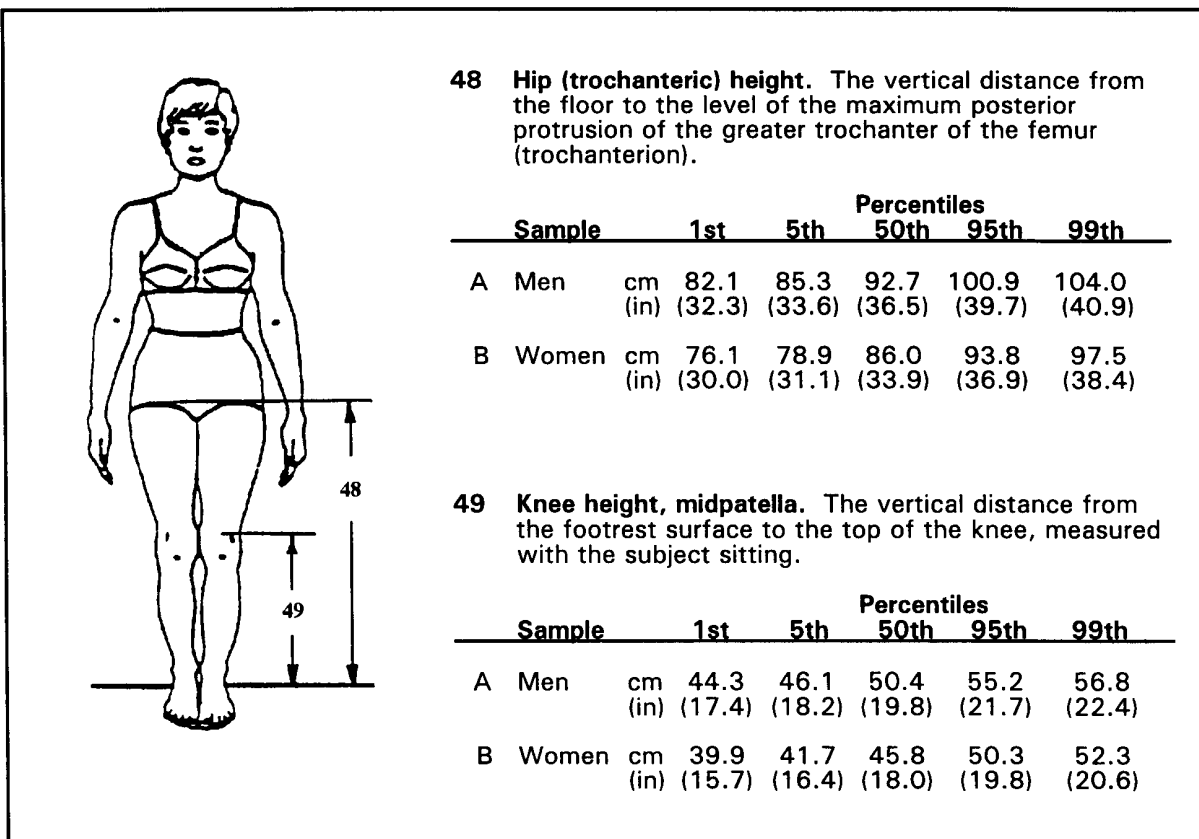
**46 Hand length.** The distance from the base of the hand at the wrist crease to the tip of the middle finger.

Sample		Percentiles				
		1st	5th	50th	95th	99th
A Men	cm (in)	17.3 (6.8)	17.9 (7.1)	19.3 (7.6)	21.1 (8.3)	21.9 (8.6)
B Women	cm (in)	15.9 (6.3)	16.5 (6.5)	18.0 (7.1)	19.7 (7.8)	20.5 (8.1)

**47 Hand circumference.** The circumference of the hand, measured around the knuckles (metacarpal-phalangeal joints).

Sample		Percentiles				
		1st	5th	50th	95th	99th
A Men	cm (in)	19.2 (7.6)	19.9 (7.8)	21.3 (8.4)	23.0 (9.1)	23.7 (9.3)
B Women	cm (in)	16.7 (6.6)	17.3 (6.8)	18.6 (7.3)	20.0 (7.9)	20.7 (8.2)

Exhibit 14.3.2.1 (continued) Static human physical characteristics (standing position)



### 14.3.3 Dynamic (mobile) body characteristics

#### 14.3.3.1 Range of whole body motion

This section presents: (1) information concerning the range of whole body motion characteristics, and (2) design guidelines and data on joint and body motion. Where such data are in other sections with application topics such as design for maintenance and workplace design, cross references are provided.

Efficiency and accuracy of task performance can be maintained only if required body movements are within safe and comfortable limits. Human variability in range of body and joint movement is attributable to many factors, including the following:

- Age becomes a factor after age 60, at which time mobility has decreased 10 percent from youth.
- Sex differences favor greater range in females at all joints except the knee.
- Body build is a significant factor. Joint mobility decreases significantly as body build ranges from the very slender, through the muscular, to the obese.
- Exercise increases movement range. Weight training, jogging, and the like may tend to shorten certain muscle groups or increase their bulk so movement is restricted.

- e. Fatigue, disease, body position, clothing, and environment are other factors affecting mobility.

This section provides introductory definitions related to the angular motion of skeletal joints. Knowledge of the range of joint motion helps the designer determine the placement and allowable movement of controls, tools, and equipment.

- **14.3.3.1.1 Trunk movement.** Workplace designs based upon design-driven body positions shall allow enough space to move the trunk of the body. The design shall be based upon:
  - a. the required tasks and human functions,
  - b. the need for optimal positions for applying forces, and
  - c. the need for comfortable body adjustments and movements.
- **14.3.3.1.2 Whole body movement.** If large forces that are greater than 13.6 kg (29.98 lb) or large control displacements that are more than 380 mm (14.96 in) in a fore-aft direction are required, the maintainer shall be given enough space to move his or her entire body.

### 14.3.3.2 Joint motion

Joint motion capabilities make body movements possible. Joint movement is measured at the angle formed by the long axes of two adjoining body segments or at the angle formed by a body segment and a vertical or horizontal plane. The total range of motion is measured between the two extreme positions of the joint. The types of movement are defined below and are illustrated in exhibits which follow.

**Definitions.** **Abduction** is movement away from the midline of the body. **Adduction** is movement toward the midline. **Circumduction** is a continuous circular movement of a limb. **Depression** is the lowering of a body member from its normal position. **Elevation** is the raising of a body member from a normal position. **Extension** is the straightening of a limb or an increase in the angle between parts of the body. **Flexion** is the process of bending a limb or decreasing the angle between parts of the body. **Lateral rotation** is turning away from the midline of the body, while **medial rotation** is turning toward the midline of the body. **Pronation** is the downward turning of the palm, or lying face down and supination is the upward turning of the palm, or lying face up.

- **14.3.3.2.1 Single joint movements.** Designers and human factors specialists shall use the data in exhibit 14.3.3.2.1 for design problems involving the movement of a single joint. This exhibit presents single joint movement ranges for males and females.

Exhibit 14.3.3.2.1 Joint movement ranges

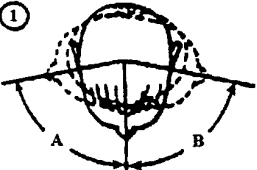
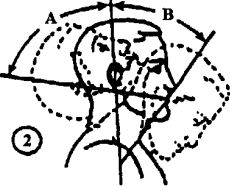
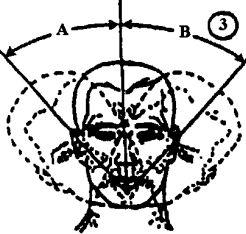
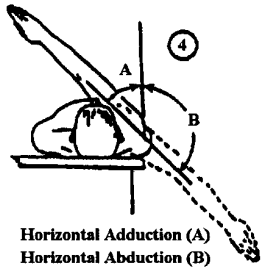
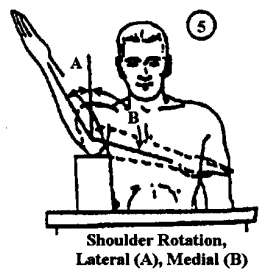
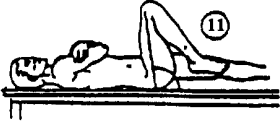
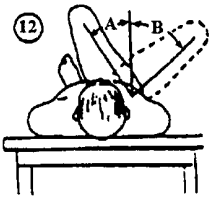

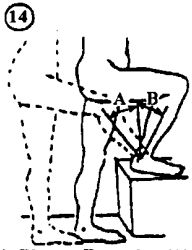
 <p>1 Neck Rotation, Right (A), Left (B)</p>	Range of motion (degrees)				
	Males		Females		
<b>Joint movement</b>	<b>5th percentile</b>	<b>95th percentile</b>	<b>5th percentile</b>	<b>95th percentile</b>	
Neck, rotation right	73.3	99.6	74.9	108.8	
Neck, rotation left	74.3	99.1	72.2	109.0	
 <p>2 Neck Extension (A) Flexion (B)</p>	Range of motion (degrees)				
	Males		Females		
<b>Joint movement</b>	<b>5th percentile</b>	<b>95th percentile</b>	<b>5th percentile</b>	<b>95th percentile</b>	
Neck, flexion	34.5	71.0	46.0	84.4	
Neck, extension	65.4	103.0	64.9	103.0	
 <p>3 Neck Lateral Bend Right (A), Left (B)</p>	Range of motion (degrees)				
	Males		Females		
<b>Joint movement</b>	<b>5th percentile</b>	<b>95th percentile</b>	<b>5th percentile</b>	<b>95th percentile</b>	
Neck, lateral right	34.9	63.5	37.0	63.2	
Neck, lateral left	35.5	63.5	29.1	77.2	
 <p>4 Horizontal Adduction (A) Horizontal Abduction (B)</p>	Range of motion (degrees)				
	Males		Females		
<b>Joint movement</b>	<b>5th percentile</b>	<b>95th percentile</b>	<b>5th percentile</b>	<b>95th percentile</b>	
Shoulder, abduction	173.2	188.7	172.6	192.9	
 <p>5 Shoulder Rotation, Lateral (A), Medial (B)</p>	Range of motion (degrees)				
	Males		Females		
<b>Joint movement</b>	<b>5th percentile</b>	<b>95th percentile</b>	<b>5th percentile</b>	<b>95th percentile</b>	
Shoulder, rotation lat	46.3	96.7	53.8	85.8	
Shoulder, rotation med	90.5	126.6	95.8	130.9	

Exhibit 14.3.3.2.1 (continued) Joint movement ranges

<p>Shoulder Flexion (A), Extension (B)</p>	Range of motion (degrees)			
	Males		Females	
	<u>5th percentile</u>	<u>95th percentile</u>	<u>5th percentile</u>	<u>95th percentile</u>
Shoulder, flexion	164.4	210.9	152.0	217.0
Shoulder, extension	39.6	83.3	33.7	87.9
<p>Elbow Flexion (B), Extension (A)</p>	Range of motion (degrees)			
	Males		Females	
	<u>5th percentile</u>	<u>95th percentile</u>	<u>5th percentile</u>	<u>95th percentile</u>
Elbow, flexion	140.5	159.0	144.9	165.9
<p>Forearm Supination (A), Pronation (B)</p>	Range of motion (degrees)			
	Males		Females	
	<u>5th percentile</u>	<u>95th percentile</u>	<u>5th percentile</u>	<u>95th percentile</u>
Forearm, pronation	78.2	116.1	82.3	118.9
Forearm, supination	83.4	125.8	90.4	139.5
<p>Wrist Ulnar Bend (A), Radial Bend (B)</p>	Range of motion (degrees)			
	Males		Females	
	<u>5th percentile</u>	<u>95th percentile</u>	<u>5th percentile</u>	<u>95th percentile</u>
Wrist, radial	16.9	36.7	16.1	36.1
Wrist, ulnar	18.6	47.9	21.5	43.0
<p>Wrist Flexion (A), Extension (B)</p>	Range of motion (degrees)			
	Males		Females	
	<u>5th percentile</u>	<u>95th percentile</u>	<u>5th percentile</u>	<u>95th percentile</u>
Wrist, flexion	61.5	94.8	68.3	98.1
Wrist, extension	40.1	78.0	42.3	74.7

## Exhibit 14.3.3.2.1 (continued) Joint movement range

 <p>Hip Flexion</p>	Range of motion (degrees)			
	Males		Females	
	5th percentile	95th percentile	5th percentile	95th percentile
<u>Joint movement</u>	<u>percentile</u>	<u>percentile</u>	<u>percentile</u>	<u>percentile</u>
Hip, flexion	116.5	148.0	118.5	145.0
 <p>Hip Adduction (A), Abduction (B)</p>	Range of motion (degrees)			
	Males		Females	
	5th percentile	95th percentile	5th percentile	95th percentile
<u>Joint movement</u>	<u>percentile</u>	<u>percentile</u>	<u>percentile</u>	<u>percentile</u>
Hip, abduction	26.8	53.5	27.2	55.9
 <p>Knee Flexion, Prone</p>	Range of motion (degrees)			
	Males		Females	
	5th percentile	95th percentile	5th percentile	95th percentile
<u>Joint movement</u>	<u>percentile</u>	<u>percentile</u>	<u>percentile</u>	<u>percentile</u>
Knee, flexion	118.4	145.6	125.2	145.2
 <p>Ankle Plantar Extension (A), Dorsi Flexion (B)</p>	Range of motion (degrees)			
	Males		Females	
	5th percentile	95th percentile	5th percentile	95th percentile
<u>Joint movement</u>	<u>percentile</u>	<u>percentile</u>	<u>percentile</u>	<u>percentile</u>
Ankle, planar	36.1	79.6	44.2	91.1
Ankle, dorsi	8.1	19.9	6.9	17.4

- 14.3.3.2.2 **Range of motion for two joints.** Exhibit 14.3.3.2.2 shall be used for design problems involving the motion of two joints. Designers shall avoid using single joint movement data for adjacent joints because they are usually not additive.

**Discussion.** The range of joint movement is drastically reduced by movement of the adjacent joint. Exhibit 14.3.3.2.2 defines the change in range of motion of a



given joint when complemented by movement of the adjacent joint.

**Example.** The following illustrates how exhibit 14.3.3.2.2 is to be used. The first entry is read: the average shoulder has a full range of extension of 59.3 degrees with the elbow in a neutral position (locked in hyperextension). When shoulder extension was measured with the elbow flexed to one third of its full joint movement range (these movements can be determined from illustrations six and seven in the previous exhibit), the mean value of shoulder extension was found to increase by 1.6 degrees, or approximately 103 percent of the base value. The results for other movements and adjacent joint positions are presented in a similar manner.

**Exhibit 14.3.3.2.2** Change in range of joint movement with movement in an adjacent joint

Two-joint movement	Full range of 1st (degrees)	Change in range of movement of 1st joint (degrees)				
		Movement of 2nd joint (fraction of full range)				
		Zero	1/3	1/2	2/3	Full
Shoulder extension (1) with elbow flexion (2)	59.3	+ 1.6 deg (102.7%)		+ 0.9 deg (101.5%)	+ 5.3 deg (108.9%)	
Shoulder flexion (1) with elbow flexion (2)	190.7	-24.9 deg (86.9%)		-36.1 deg (81.0%)	-47.4 deg (75.0%)	
Elbow flexion (1) with shoulder extension (2)	152.2			-3.78 deg (97.5%)		-1.22 deg (99.2%)
Elbow flexion (1) with shoulder flexion (2)	152.2	-0.6 deg (99.6%)		-0.8 deg (99.5%)		-69.0 deg (54.7%)
Ankle plantar flexion (1) with knee flexion (2)	48.0	-3.4 deg (92.9%)		+ 0.2 deg (100.4%)		+ 1.6 deg (103.3%)
Knee flexion (1) with ankle planar flexion (2)	127.0			-9.9 deg (92.2%)		-4.7 deg (96.3%)
Knee flexion (1) with ankle dorsiflexion (2)	127.0					-8.7 deg (93.9%)
Knee flexion (1) with hip flexion (2)	127.0			-19.6 deg (84.6%)		-33.6 deg (73.5%)

- 14.3.3.2.3 **Design limit approach.** The design limit approach, which concerns the selection of correct percentiles for the design solution and which is prescribed in section 14.1.2 shall be applied

to design issues concerning the range of motion of singular and multiple joints.

- **14.3.3.2.4 Use of this guide's dynamic data.** Designers and human factors specialists shall use the dynamic anthropometric and biomechanics guidelines found throughout this guide where applicable to dynamic tasks. They shall obtain data for critical dynamic task that are unique to the system mission. These data may be obtained from other appropriate anthropometry sources or from appropriate measures on a suitable sample.

Examples, though not an exhaustive list, of additional data from other sections of the guide that have some basis in user mobility and general task dynamics are:

- a. mobile work space dimensions in section (see paragraph 9.4.2.2),
- b. visual line-of-sight and optimal display and control zones in sections 7 and 9 (see paragraphs 7.2.1.6.3, 7.2.1.6.8, 9.5.4.2, and 9.5.4.4),
- c. whole body access and passageways in section 9 (see paragraphs 9.3.1.1 and 9.3.4.6),
- d. seated and standing workstations and consoles in section 9 (see paragraphs 9.4.3.1, 9.5.1.1, and 9.5.4.4), and
- e. visual display terminals in section 9 (see section 9.6).

**Discussion.** Most dynamic tasks will be system specific. Critical tasks are those whose efficient performance is critical to the mission and to the safety of users, system, facility, or equipment.

## 14.4 Reach

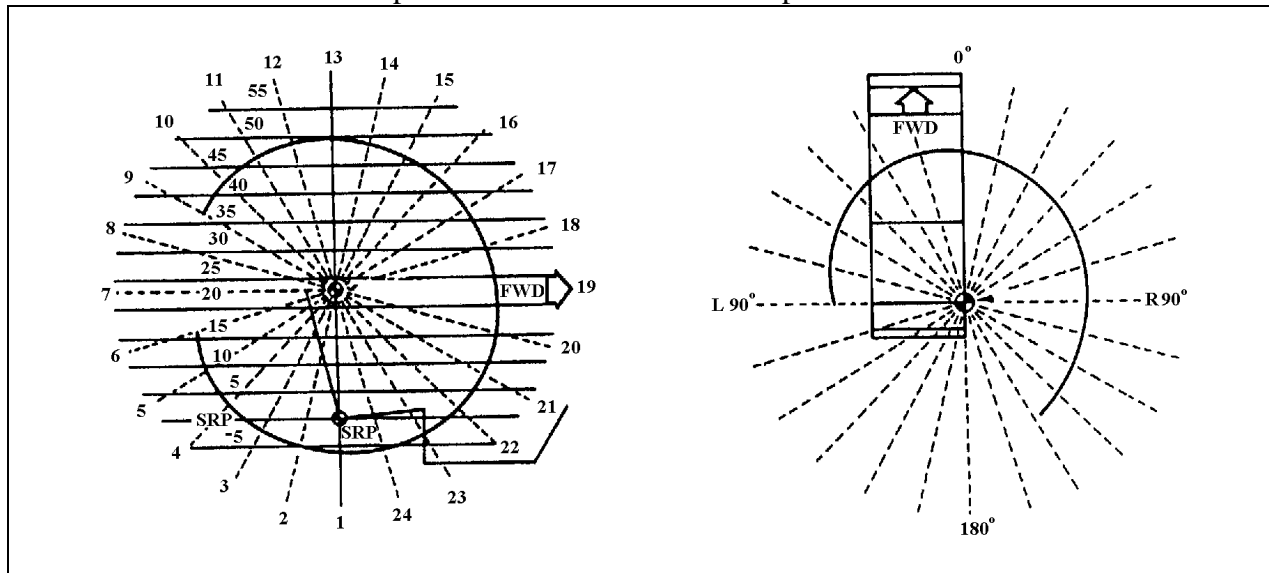
Reach limits are clearly dependent on the task, motion, and function to be accomplished by the reach action. Limited reach data on standard anthropometric positions are available in sources of static and dynamic anthropometric data. Reach envelopes need to be constructed for actual working positions and for explicit design purposes. Reach envelopes may be related to a body reference point (such as the shoulder joint), to a measurement apparatus point, or to a design point (such as a seat reference point). This section provides design criteria and guidelines for using reach data and constructing reach envelopes.

- **14.4.1 Task and body position effects.** The following task considerations shall be taken into account in order to establish reference points and to obtain the reach information needed to construct a reach envelope:
  - a. the nature and requirements of the task to be performed (see also paragraphs 14.3.1.2 and 14.4.4 for the nature of the reach task),

- b. body position while reaching (standing, seated, seat back and seat pan angles, and others),
  - c. whole body movement capabilities and restraints (seat belts, harnesses, necessary and permitted movements of the torso),
  - d. design purposes such as: to accommodate the appropriate portion of the population, to enhance task performance, or to avoid striking reachable surfaces, and
  - e. equipment locations that interfere with reach, vision or intercommunications.
- **14.4.2 Reach envelope data collection.** Designers and human factors specialists should understand that reach envelope measurement data are often related to the data collection procedures and apparatus. Often data can be found or should be collected to relate the design reference point of concern to the reach capabilities of the actual users. Another factor in data collection is the amount of whole body movement allowed. For example, consider bending the torso forward so that one or both shoulders no longer touch the seat back.

**Example.** Exhibit 14.4.2 shows an example in which reach measurement is related to the seat reference point from a restrained shoulder level. In the left graph, a side view reference plane is shown, and in the right graph, a top view is shown in terms of reach angles. All measures and dimensions are relative to the apparatus.

**Exhibit 14.4.2** Reach envelopes in vertical and horizontal planes



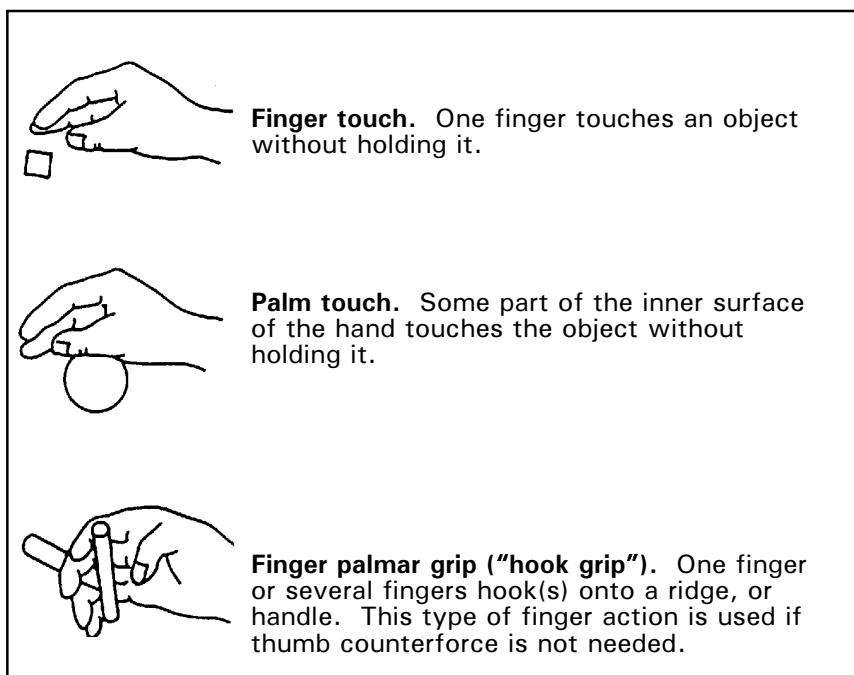
**Discussion.** An issue surrounding the application of reach data is how to relate static anthropometric reach dimensions, shoulder

joint points, data collection procedures and apparatus reference points, and design reference points. Most reach measurements are made relative to an apparatus reference point. A further complication is that the apparatus and design seat reference point may not be the same or might not reflect the same seat configurations (back and pan angles).

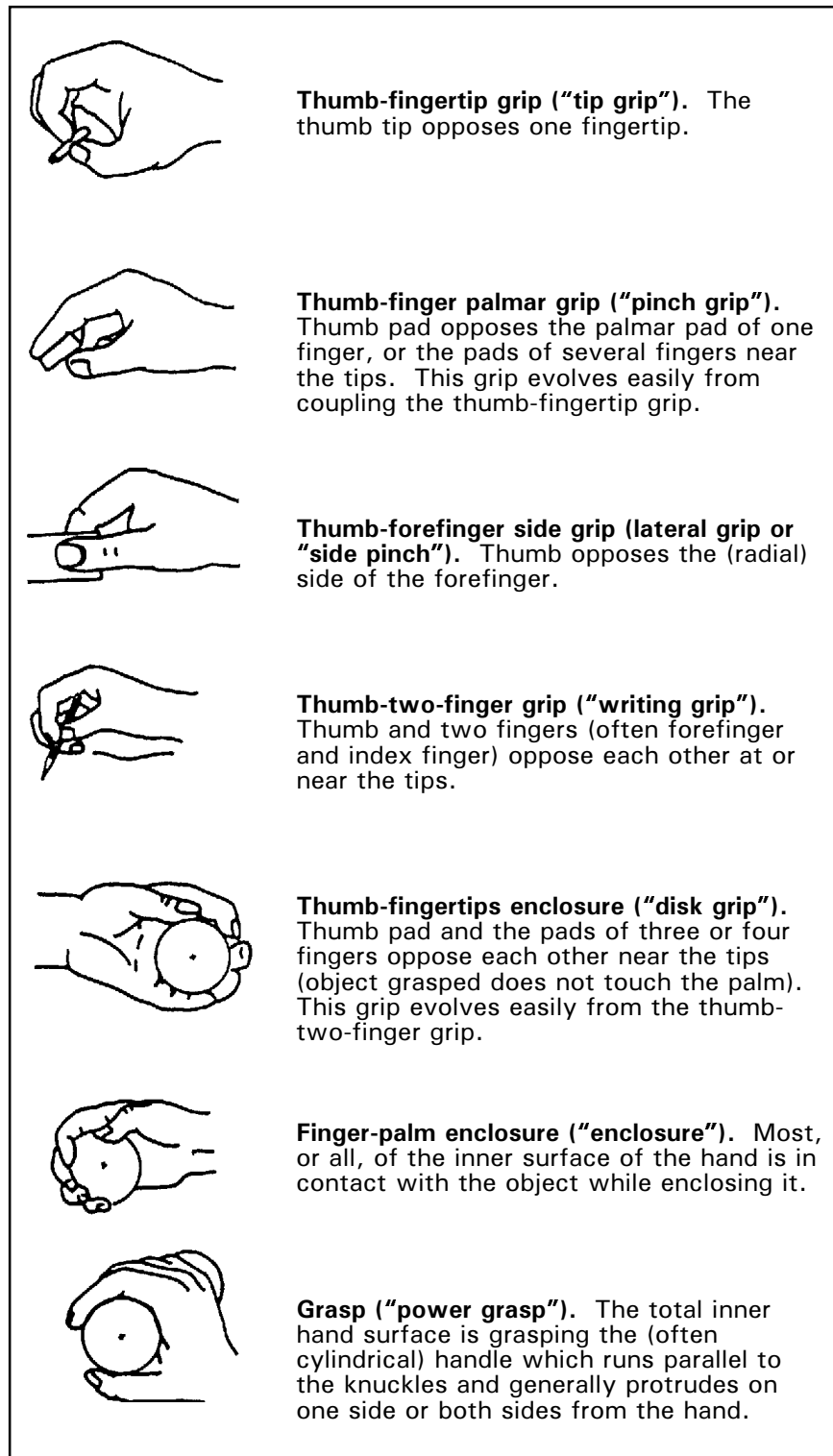
**Definition. Seat reference point** is a point in the mid-sagittal plane where the seat back and seat pan intersect.

- **14.4.3 Reach envelopes for control actions.** Reach envelopes for control tasks shall be based upon 5th percentile female reach data so as to accommodate at least 95 percent of the population.
- **14.4.4 Reach envelope interaction with the reach task.** Reach envelope data shall be collected or modified for the tasks, motions, or functions to be accomplished by the reach. Exhibit 14.4.4 (a) defines some task demands (touch, grip, and grasp) that affect reach characteristics and measures.

**Exhibit 14.4.4 (a)** Touch, grip, and grasp functions and interact with arm reach



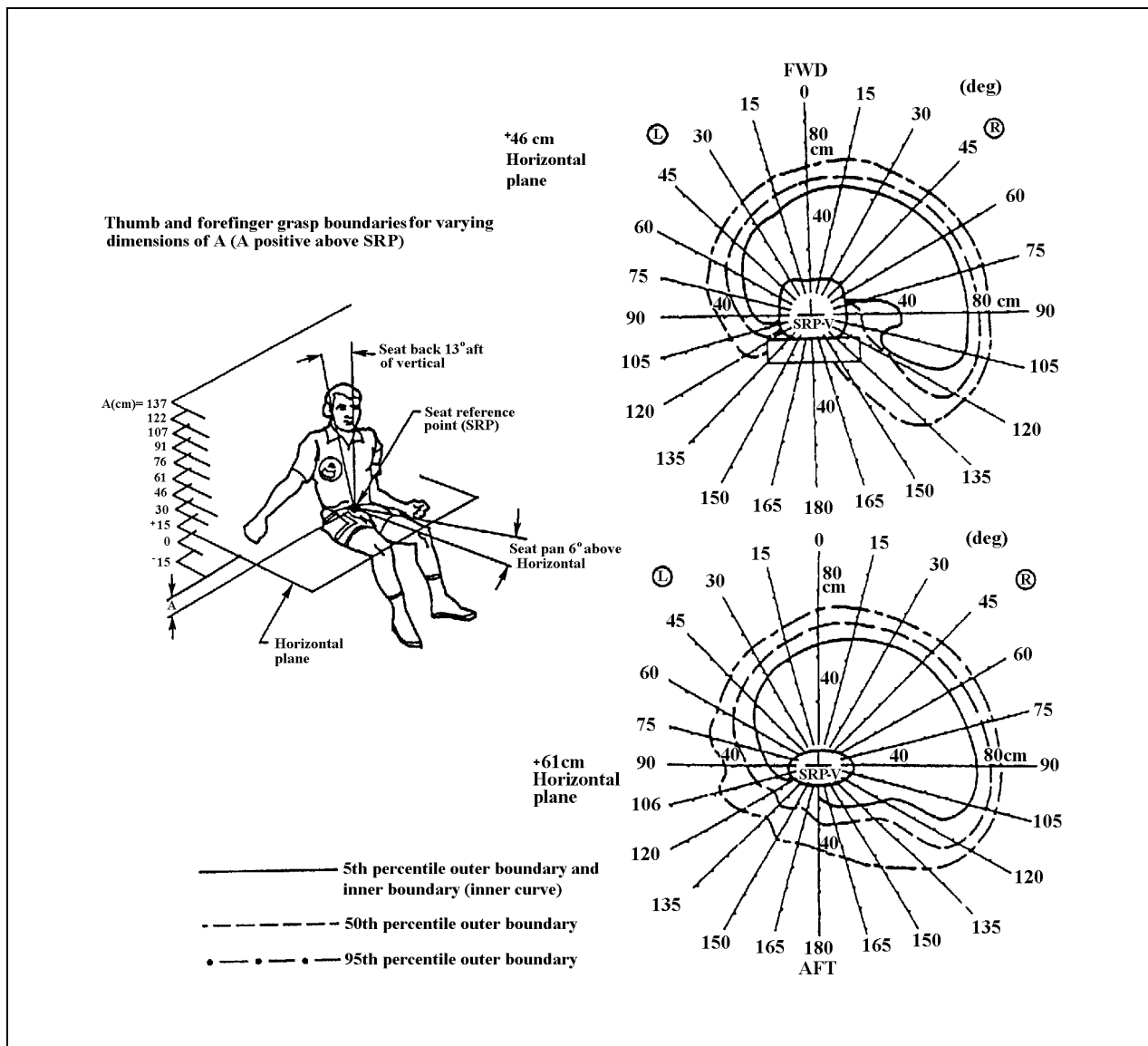
**Exhibit 14.4.4 (a) (continued)** Touch, grip, and grasp functions that interact with arm reach



**Discussion.** Fingertip touch results in the largest reach dimensions appropriate for touch controls. Other grasp functions would reduce the reach envelope. Two handed operations, greater precision, and frequent or continuous operation would necessitate locating the task closer to the body. Bulky clothing could affect reach capabilities.

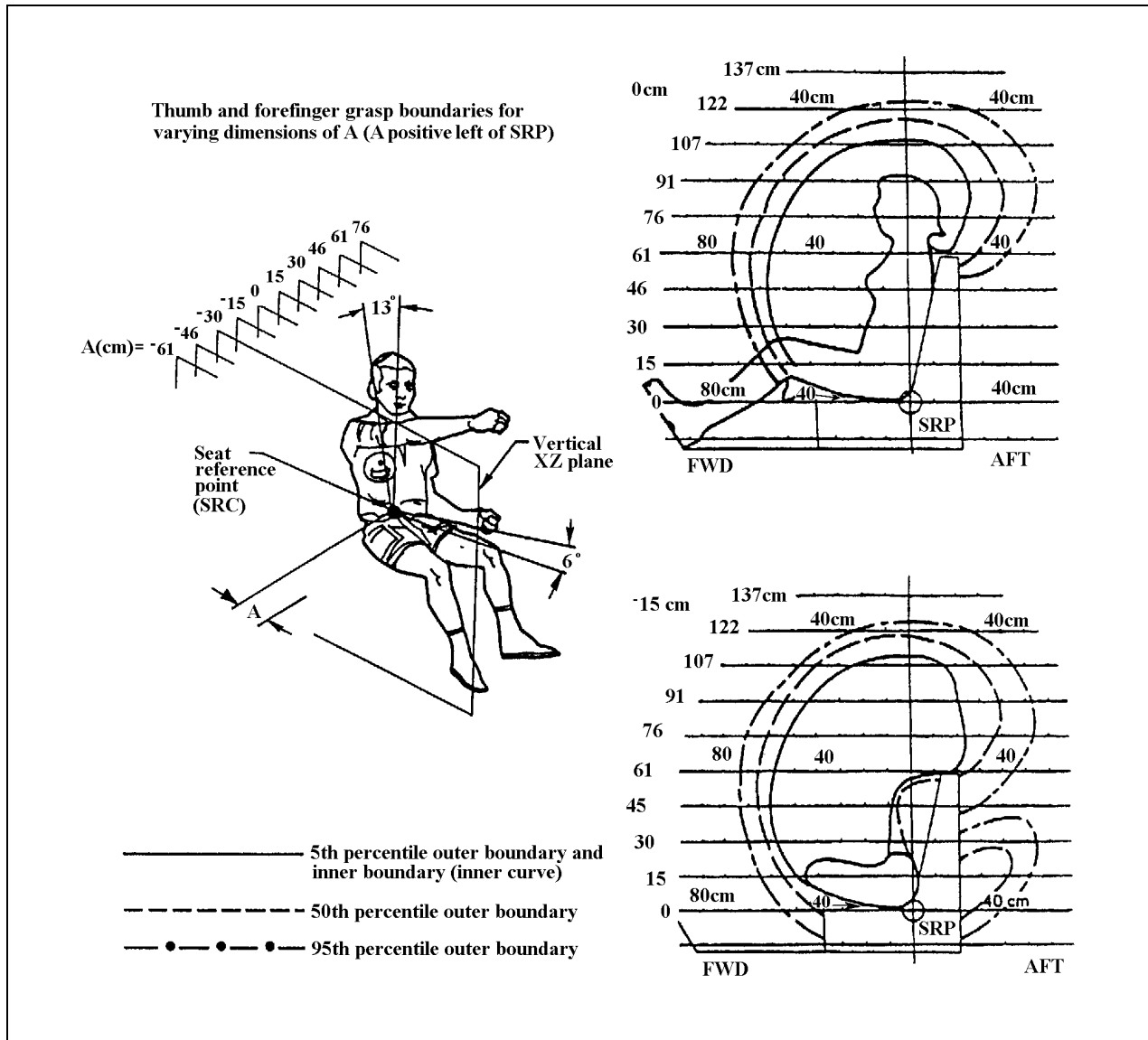
**Examples.** Exhibits 14.4.4 (b) and (c) present 5th percentile female reach envelope data as examples of one possible presentation for such data. The data represent right hand reach for a fingertip grasp task. In exhibit 14.4.4 (b) horizontal contours are shown at the 46 and 61 cm levels.

**Exhibit 14.4.4 (b)** Thumb and forefinger grasp boundary data for females in the 46 cm and 61 cm horizontal planes



In exhibit 14.4.4 (c) vertical planes are shown for the 0 and -15 cm planes. For design use, data would be presented for other horizontal and vertical planes. For this example, shoulders were restrained against the seat.

**Exhibit 14.4.4 (c)** Thumb and forefinger grasp boundary data for females in the 0 and -15 cm vertical planes



Three factors can affect three-dimensional reach envelopes: the effects of different hand manipulation tasks, the effects of permitting torso and shoulder movement, and the effects of the seat back angle of the data collection apparatus. For instance, the exhibit shows thumb and forefinger grasp. Not shown is that fingertip touch reach would increase by 7.0 cm (2.8 in) and full

hand grasp reach would decrease by -5.5cm (2.2 in) from their fingertip grasp reach values.

Additional data also not shown in the exhibit reveals that if the seat back angle were changed from 13 degrees rearward (as shown in the exhibits) to the vertical position, that is to 90 degrees, then reach measures in a horizontal plane from 0 degrees (arm straight forward and horizontal) to 90 degrees to the right increase as follows:

- a. at 0 degrees, by 1.02 cm (.40 in);
  - b. at 15 degrees, by 1.27 cm (.50 in);
  - c. at 45 degrees, by .94 cm (.37 in);
  - d. at 60 degrees, by .66 cm (.26 in); and
  - e. at 90 degrees, by .25 cm (.10 in).
- **14.4.5 Strength or fine manipulation.** Tasks which require strength or fine manipulation, as well as repetitious tasks should be located well within the perimeter of the reach limit envelope.

**Discussion.** The strength that can be exerted varies considerably throughout the reach envelope. As was noted in the previous example, the reach envelope varies with the type of grasp required in defining the envelope. This rule points out that one may need to further accommodate the task location by the strength, fine manipulation, or repetitive nature of the tasks to be performed. In these cases, consider the capabilities of the small (5th or 1st percentile ) female user and also provide sufficient space and adjustability to accommodate the large male.

## 14.5 Human strength and handling capacity

The designer and human factors specialist need to know the limits and ranges of human strength to create designs that are within the capabilities of potential users. If demands on human strength are too high, inefficient and unsafe worker performance will result. If the designer underestimates strength, unnecessary design effort and expense may be incurred.

This section introduces muscle strength factors, and provides criteria and guidelines on control forces, as well as push and pull forces. This section also provides supplemental criteria and guidelines on lifting and carrying.

### 14.5.1 Muscle strength factors

The forces delivered by the human body depend on the contractile strength of the muscles, and the mechanical advantages of the body lever system with the joints serving as fulcra and the long bones serving as levers.

Knowledge of some of the many factors that relate to muscular strength may aid design personnel in understanding human



physical capabilities. In addition to the strength capabilities of various body members, other factors include: (1) age, (2) endurance, (3) gender, (4) body build, (5) body position, (6) handedness, (7) exercise, (8) diet and drugs, (9) diurnal variation, and (10) emotional and fatigue states. Gender and handedness are discussed below while strength limit factors are presented in the criteria and guidelines throughout section 14.5.

**Discussion.** In general, females are about 35 to 85% as strong as males with varying differentials for various muscle groups. Gender differences favor greater range in joint motion in females at all joints except the knee. The preferred hand and arm are approximately 10% stronger than the non-preferred hand and arm.

**Definitions.** There are three basic categories of strength: (1) **static strength**, also known as isometric strength, which is steady force exerted while the limbs are in a stationary or static position, (2) **dynamic strength**, which is a force exerted by limbs moving in a smooth manner over time, such as while lifting an object, and (3) **explosive strength**, which is the application of peak amounts of strength for short periods of time, usually periodically, such as in running or sprinting.

## 14.5.2 Exerted forces

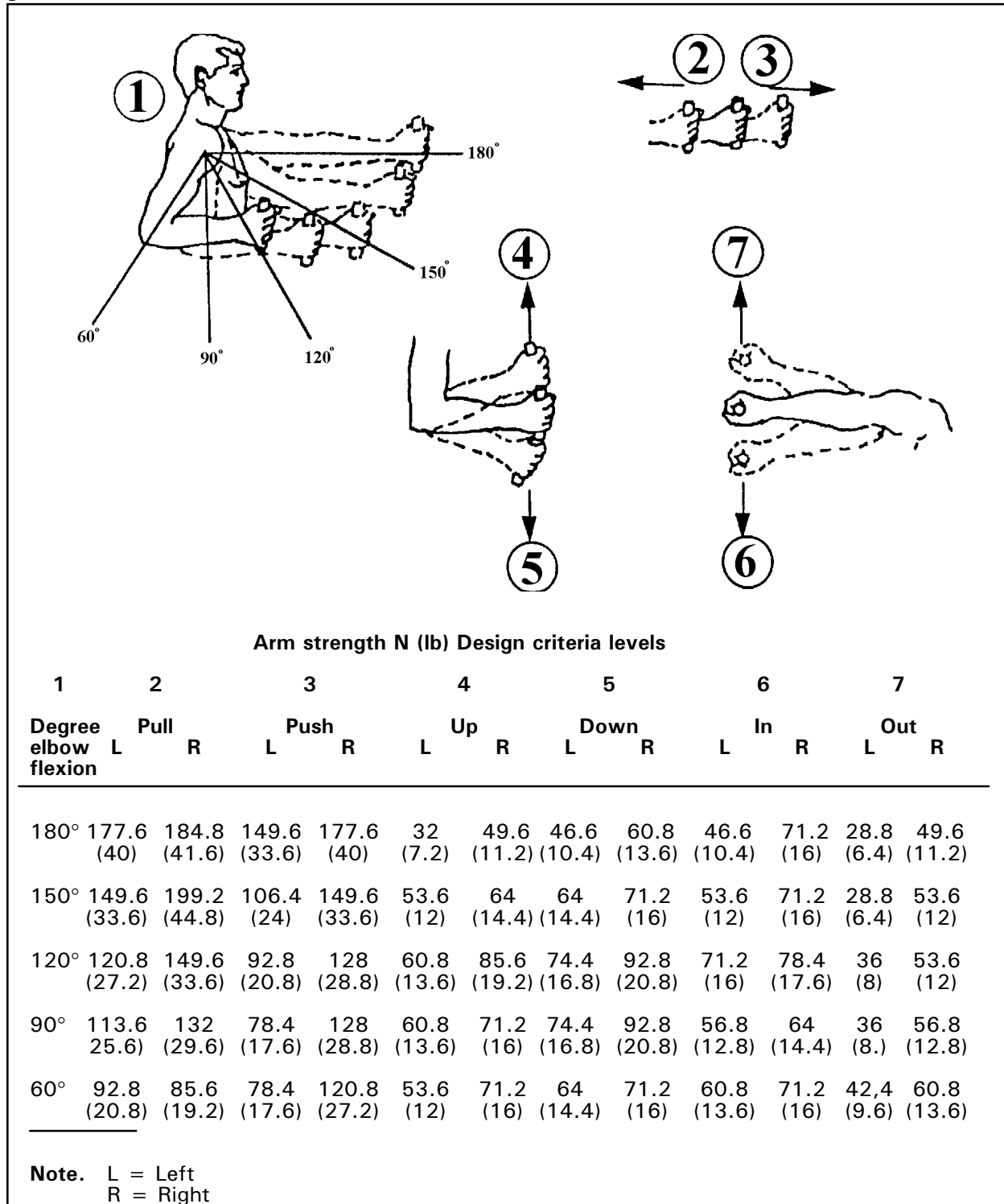
- **14.5.2.1 Maximum young male force or resistance for a control.** The maximum amount of force or resistance designed into a control should be determined by the greatest amount of force that can be exerted by the weakest person likely to operate the control. Control force limits, like most strength design limits, should be based upon the 5th percentile (or, for critical tasks, the 1st percentile) of the female user population. Female strength data when it becomes available will be included in MIL-HDBK-759B.

Exhibits 14.5.2.1 (a) and (b) represent 80% of the maximum exertion forces for the 5th percentile male for the arm, hand and thumb. Since the experimental conditions used to collect the source data yielded maximum possible exertion values for young men, these values were too high for design purpose. For design, one does not want to deliberately or consistently require maximum exertions. Thus these source values were reduced by 20% before applying them as design criteria. Male data should be selected based upon the body components involved in the specific exertion task. To estimate female strength, male data should be further reduced according to paragraph 14.5.2.4. Females can apply most strength when torso, back, and legs are major contributors. Female upper body and arm strength are weakest (see also comparative lifting strength information paragraph 14.5.2.4 and 6.2.5.1.5).

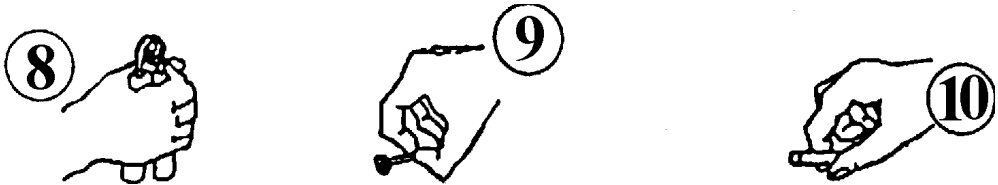
**Discussion.** The maximum force that can be applied will depend on such factors as the type of control, the body member used to operate it, the position of this body

member during control operations, the general position of the body, and whether or not support is provided by backrests.

**Exhibit 14.5.2.1** Male muscle strength of the arm, hand, and thumb for control forces (5th percentile values)



**Exhibit 14.5.2.1 (continued)** Design criteria for male muscle strength of the arm, hand, and thumb for control forces (5th percentile values)



Hand and thumb-finger strength N (lb)				
	8		9	10
	Hand grip L	Hand grip R	Thumb-finger grip (palmer)	Thumb-finger grip (tips)
Momentary hold	200 (44.8)	208 (47.2)	48 (10.4)	48 (10.4)
Sustained hold	116 (26.4)	124 (28)	28 (6.4)	28 (6.4)

**Note.** L = Left  
R = Right

- **14.5.2.2 Increasing strength values.** Strength values shall be slightly increased if:

  - a. a lifting yoke or other special harness is to be used,
  - b. the object is unusually easy to handle,
  - c. the required force must be applied infrequently or only for a few seconds, if more than one per 30 seconds, decrease by .30 or
  - d. the working body parts are provided with suitable support.
- **14.5.2.3 Decrementd strength values.** Strength values shall be decremented if:

- a. the object is very difficult to handle (for example, bulky or slippery),
  - b. access and work space are less than optimum,
  - c. the required force must be applied continuously for more than one minute (strength decreases after 5 seconds), if more than once per 30 seconds decrease by 30 per cent.
  - d. the object must be finely positioned or delicately handled, or
  - e. the task must be performed repeatedly.
- **14.5.2.4 Comparative strength.** Research has produced little insight into the strength of women relative to men. New female strength data are to be added to MIL-HDBK-759 in the near future. The following strength relationships developed by the US Army Research Institute of Environmental Medicine should be used until better data becomes available:
- a. For upper extremities, females strength is 56.5% of men.
  - b. For lower extremities, female strength is 64.2% of men.
  - c. For trunk extremities, female strength is 66.0% of men.

**Explanation.** These numbers may serve as a design guideline until more information becomes available.

- **14.5.2.5 Preventing tremor in positive control performance.** Tremor is important in activities in which a body member is maintained in a precise position or motion (tasks involving fine continuous control, detailed drawing, tracking, tracing, cutting, or painting). The following features should be designed into systems or equipment, where applicable, to help reduce tremor and ensure positive control performance of fine detailed tasks:
- a. ensure that visual reference can be used,
  - b. provide support of the body and the member involved, for example, the hand or arm,
  - c. support the hand because tremor is less if the hand is 203.2 mm (8 in) above or below the heart level, and
  - d. provide mechanical friction in the control device to add enough resistance to movement to partially counteract the energy of the vibrations of the body member.

**Definition and discussion.** Tremor is the oscillation of a body extremity which may occur along with an effort to maintain a fixed position or direction. The degree of tremor is measured by the distance or number of departures from the fixed path or position per unit of time. Tremor increases when (1) effort is made not to

tremble, and (2) fatigue is present. It is greatest in vertical motion, less in front-to-back motion, and least in side-to-side motion.

**14.5.3 Push and pull forces**

- **14.5.3.1 Horizontal direction of force.** Manual horizontal push and pull forces that are initially necessary to set an object in motion, or to sustain the motion over a period of time, should not exceed the values given in exhibit 14.5.3.1. For the second or third person applying horizontal forces, the value in the exhibit's first column should be doubled or tripled, respectively. For each additional person (beyond the third) another 75 percent of the force value in the first column should be added.

**Explanation.** The exhibit shows maximum push and pull forces that a designer would be expected to use when appropriate body positions, support, and traction conditions are provided. Use of the maximum values shown in the exhibit is predicated upon a suitable surface for force exertion (vertical with rough surface approximately 400 mm (15.75 in) wide and between 0.51 - 1.27 m (1.673 - 4.167 ft) above the floor) to allow force application with the hands, shoulders, or back.

**Exhibit 14.5.3.1 Horizontal push and pull forces that can be exerted**

Exertable horizontal force	Applied with	Condition ( $\mu$ : coefficient of friction)
110 N (24.7 lbf) push or pull	both hands or one shoulder or the back	with low traction $0.2 < \mu < 0.3$
200 N (45.0 lbf) push or pull	both hands or one shoulder or the back	with medium traction $\mu \approx 0.6$
240 N (54.0 lbf) push	one hand	if braced against a vertical wall 510-1520 mm (20.08-59.84 in) from and parallel to the push panel
310 N (70.0 lbf) push or pull	both hands or one shoulder or the back	with high traction $\mu > 0.9$
490 N (110.2 lbf) push or pull	both hands or one shoulder or the back	if braced against a vertical wall 510-1780 mm (20.08-70.08 in) from and parallel to the panel or if anchoring the feet on a perfectly non-slip ground (like a footrest)
730 N (164.1 lbf) push	the back	if braced against a vertical wall 580-1090 mm (22.83-42.91 in) from and parallel to the push panel or if the anchoring the feet on a perfectly non-slip ground (like a footrest)

- **14.5.3.2 Vertical direction of force.** Required manual vertical static lift forces, should not exceed the applicable 5th percentile peak or mean force values given in exhibit 14.5.3.2.

**Explanation.** Based upon recent experience within NIOSH the forces found in the source which studied young military personnel has been reduced by 20 percent in exhibit 14.5.3.2. The mean forces given represent force over a three second interval, beginning two seconds after it reached a minimum value of 45 N provided that it continued to exceeded this minimum. Exhibit 14.5.3.2 reflects the higher of two trials for each condition.

- **14.5.3.3 Forces for handles.** Designers shall use the force criteria for handles cited in section 6 (see paragraph 6.2.5.1.5).

**Exhibit 14.5.3.2** Static muscle strength data for vertical pull exertions



**A. Standing two-handed pull: 38 cm (15.0) level.** Standing with feet 45 cm (17.7 in) apart and knees bent; bending at the waist, grasping both sides of a 45 cm (17.7 in) handle located directly in front, 38 cm (15.0 in) above standing surface, and pulling, using primarily arms, shoulders, and legs

Strength measurements	5th percentile		95th percentile	
	Male	Female	Male	Female
Mean force (N)	737.5	330.9	1354.5	817.6
Mean force (lbf)	(165.80)	(74.39)	(304.50)	(183.80)
Peak force (N)	844.7	396.9	1437.2	888.3
Peak force (lbf)	(189.90)	(89.23)	(323.10)	(199.70)



**B. Standing two-handed pull: 50 cm (19.7 in) level.** Standing with feet 45 cm (17.7 in) apart and knees straight; bending at the waist, grasping both sides of a 45 cm (17.7 in) handle located directly in front, 50 cm (19.7 in) above standing surface, and pulling, using primarily arms and shoulders

Strength measurements	5th percentile		95th percentile	
	Male	Female	Male	Female
Mean force (N)	758.0	326.1	1341.6	840.7
Mean force (lbf)	(170.41)	(73.31)	(301.60)	(189.00)
Peak force (N)	830.9	374.1	1441.7	905.2
Peak force (lbf)	(186.79)	(84.10)	(324.11)	(203.50)



**C. Standing two-handed pull: 100 cm (39.4 in) level.** Standing erect with feet 45 cm (17.7 in) apart, grasping both sides of a 45 cm (17.7 in) handle located directly in front, 100 cm (39.4 in) above the standing surface, and pulling, using the arms

Strength measurements	5th percentile		95th percentile	
	Male	Female	Male	Female
Mean force (N)	444.4	185.0	931.0	443.0
Mean force (lbf)	(99.91)	(41.59)	(209.30)	(99.59)
Peak force (N)	504.0	218.0	988.4	493.3
Peak force (lbf)	(113.30)	(49.01)	(222.20)	(110.90)

## Exhibit 14.5.3.2 (continued) Static muscle strength data for vertical pull exertions



- D. **Standing two-handed push: 150 cm (59.1 in) level.** Standing erect with feet 45 cm (17.7 in) apart grasping from below, both sides of a 45 cm (17.7 in) handle located directly in front, 150 cm (59.1 in) above standing surface, pushing upward using arms and shoulders

Strength measurements	5th Percentile		95th Percentile	
	Male	Female	Male	Female
Mean force (N)	408.8	153.5	1016.9	379.9
Mean force (lbf)	(91.9)	(34.51)	(228.61)	(85.41)
Peak force (N)	472.8	187.7	1094.3	430.1
Peak force (lbf)	(106.29)	(42.20)	(246.02)	(96.69)



- E. **Standing one-handed pull: 100 cm (39.4 in) level.** Standing erect with feet 15 cm (5.9 in) apart dominant hand grasping underside of D-ring located directly to the side, 100 cm (39.4 in) above standing surface, pulling upward while keeping shoulder square and other arm relaxed at side

Strength measurements	5th Percentile		95th Percentile	
	Male	Female	Male	Female
Mean force (N)	214.8	102.8	627.6	283.8
Mean force (lbf)	(48.29)	(23.11)	(141.09)	(63.8)
Peak force (N)	258.9	131.7	724.2	322.5
Peak force (lbf)	(58.20)	(29.61)	(162.81)	(72.50)



- F. **Seated one-handed pull: seat centerline 45 cm (39.4 in) level.** Sitting erect with feet 55 cm (21.7 in) apart, dominant hand grasping underside of D-ring located directly to the front, 45 cm (17.7 in) above the floor, pulling upward while keeping shoulder square and other arm resting in lap

Strength measurements	5th Percentile		95th Percentile	
	Male	Female	Male	Female
Mean force (N)	222.3	106.3	678.4	391.9
Mean force (lbf)	(49.98)	(23.90)	(152.51)	(88.11)
Peak force (N)	273.1	127.2	758.4	450.6
Peak force (lbf)	(61.40)	(28.60)	(170.50)	(101.30)



Exhibit 14.5.3.2 (continued) Static muscle strength data for vertical pull exertions



**G. Seated one-handed pull: side of seat, 45 cm (17.7 in) level.**  
 Sitting erect with feet 55 cm (21.7 in) apart, dominant hand grasping underside of D-ring located a short distance to side, 45 cm (17.7 in) above the floor, pulling upward while keeping shoulders square and other arm resting in lap

Strength measurements	5th percentile		95th percentile	
	Male	Female	Male	Female
Mean force (N)	408.8	153.5	1016.9	379.9
Mean force (lbf)	(91.90)	(34.51)	(228.61)	(85.41)
Peak force (N)	472.8	187.7	1094.3	430.1
Peak force (lbf)	(106.29)	(42.20)	(246.02)	(96.69)



**H. Seated two-handed pull: centerline of seat, 38 cm (14.96 in) level.**  
 Sitting erect with feet 55 cm (21.7 in) apart, bending slightly at waist, grasping both sides of 15 cm (5.9 in) handle located directly to the front, 38 cm (15.0 in) above the floor, pulling upward using arms and shoulders, keeping arms off thighs

Strength measurements	5th percentile		95th percentile	
	Male	Female	Male	Female
Mean force (N)	214.8	102.8	627.6	283.8
Mean force (lbf)	(48.29)	(23.11)	(141.09)	(63.80)
Peak force (N)	258.9	131.7	724.2	322.5
Peak force (lbf)	(58.20)	(29.61)	(162.81)	(72.50)



**I. Seated two-handed pull: centerline of seat, 50 cm (19.7 in) level.**  
 Sitting erect with feet 55 cm (21.7 in) apart, bending slightly at the waist, grasping both sides of 15 cm (5.9 in) handle located directly to the front, 50 cm (19.7 in) above the floor, pulling upward using arms and shoulders, keeping arms off thighs

Strength measurements	5th percentile		95th percentile	
	Male	Female	Male	Female
Mean force (N)	222.3	106.3	678.4	391.9
Mean force (lbf)	(49.98)	(23.90)	(152.51)	(88.11)
Peak force (N)	273.1	127.2	758.4	450.6
Peak force (lbf)	(61.40)	(28.60)	(170.50)	(101.30)

### 14.5.4 Lifting and carrying

There are three major muscular components of weight-lifting: (1) the legs, (2) the arms-back, and (3) the arms. In efficiently lifting objects to different heights, these components are combined in different ways. Specifically, lifting objects to about knee height involves primarily the use of the leg component, while objects lifting to about waist level involves a combination of leg and arm-back components. Lifting objects to shoulder level or higher requires the use of all three components.

- **14.5.4.1 Lifting and carrying limits.** Data, criteria, and guidelines in section 6.2.2 shall be used to establish recommended maximum weights to be lifted and carried by one and two people. (See sections 6.2.5.1 and 6.2.5.3 for handle use and dimensions in relation to weight limits).

### 14.6 Design for physical comfort

Like thermal comfort in section 13, physical comfort may be difficult to quantify but people can perceive and express discomfort. In the physical comfort area, discomfort can become painful or result in chronic disorders. Usually there are physiological bases for discomfort. Factors that can influence perceptions of comfort and discomfort include: (1) physical and physiological condition, (2) fatigue, (3) working conditions and stress, (4) provisions for physical support, (5) impediments or restraints to movement, and (6) environmental conditions.

- **14.6.1 Adjustment capabilities.** Designers and human factors specialists should provide appropriate adjustment capabilities in workspace design (seating, body part support, and task location) that permit individuals to easily and safely adjust workspace dimensions to their preferred body positions and task locations. Such adjustability should be achieved by:
  - a. using the design limits method to accommodate the range of the population distribution between the 5th and 95th percentile statistics,
  - b. considering the practical variations in task locations which may be preferred by the workers, and
  - c. considering the frequency and duration of tasks and emphasize adjustment of the most important, frequent, and long duration tasks.
- **14.6.2 Restrictions to movement.** Designers and human factors specialists should avoid design features that unnecessarily restrict the individual worker's ability to make frequent postural adjustments. If possible, postural adjustments should be feasible and safe without interruption of the tasks.

**Discussion.** The concept of individualized form fitting seats may be appropriate for astronauts but such form fitting may be too restrictive for postural adjustments needed for most work. If fit or barriers to comfortable movement cause constant adjustments for comfort or balance, the additional muscular effort to attain comfort may contribute to muscular fatigue.

- **14.6.3 Body support.** Body part supports should be appropriate and compatible with the tasks. Necessary padding composition should be provided to accommodate soft tissue and bony protuberances without impeding motions or resulting in irritations.
- **14.6.4 Body posture.** Design features shall not require awkward body positions for operators or maintainers. Tasks that require physical exertions shall permit a range of comfortable postures appropriate for safe application of the required forces or movements.
- **14.6.5 Demands upon tasks.** Designs and design-driven tasks that could over time cause repetitive movement disorders or that risk back, neck, shoulder, wrist discomfort, stress, or injury shall be formally identified by the contractor and be reviewed by the acquisition program office. Those designs and tasks that are questionable shall be reviewed for potential equipment and task design changes or redesign. Tasks that could require special personnel selection for physical attributes, or special work-rest requirements shall be identified and reviewed for potential equipment and task redesign.

## Appendix contents

<b>Appendix A</b>	References .....	A-1
<b>Appendix B</b>	Sources .....	B-1
<b>Appendix C</b>	“Standard” actions for push buttons .....	C-1
<b>Appendix D</b>	“Standard” verbs .....	D-1
<b>Index</b>	.....	I-1
<b>Comment forms</b>	.....	after index



## Appendix A References

This appendix lists general references on topics associated with the HFDG. Government documents are listed by categories and by their alphabetic and numeric identifier codes. In cases where government documents may be known by authors names, these documents are also listed in the Government Document by author section. Government sponsored technical reports are listed both by technical report numbers (Section A.1.5) and by author (Section A.3).

Complementary documents, which could be contractually binding if the rule paragraphs in which they appear are contractually cited, are listed in Section 2 of this document entitled "Complementary Documents" and are not included in this section (unless they are also separately used as a general reference). Appendix A references are for information only and do not have contractual implications unless they are otherwise required by regulation or law.

Documents that were used "paragraph-by-paragraph" as background source material are listed by HFDG paragraph number, where applicable, in Appendix B, Sources. These briefly coded reference citations from Appendix B are included in the Appendix A reference lists to help interested users find general bibliographic information.

In Appendix A, general reference documents that may be published by industrial associations or institutes are found alphabetically by organization under A.2 Institutional Documents. Documents can be found by author under section A.3, Documents by Author.

### A.1 Government documents

#### A.1.1 Specifications

- |                      |   |
|----------------------|---|
| DON UISNCCS,<br>V1.2 | Department of the Navy (1992). <i>User interface specifications for Navy command and control systems (Version 1.2)</i> . San Diego, CA: NCCOSC, RDT&E Division.   |
| ESD-CSSR-001A        | <i>System specification for communications system segment</i> , (1986). Springfield, VA: National Technical Information Service.  |
| FAA-D-2494/b         | Department of Transportation (1984). <i>Technical instruction book manuscript: electronic, electrical, and mechanical equipment, requirements for preparation of manuscript and production of books</i> . Washington DC: Martin Marietta Air Traffic Systems. |

FAA-G2100F	Department of Transportation (1993, November) <i>Electronic equipment, general requirements specification</i> . Washington D.C: ASE-600 Federal Aviation Administration.
MIL-STD-46855B	Department of Defense (1979). <i>Human engineering requirements for military systems, equipment, and facilities</i> . Philadelphia, PA: Navy Publishing and Printing Office.
MIL-M-GCSFUI (Reference code from appendix B)	See MIL-M-87268
MIL-M-87268	Department of Defense (1992). <i>Manuals, interactive electronic technical: General content, style, format, and user-interaction requirements</i> . Philadelphia, PA: Navy Publishing and Printing Office.
NAS-1000, 19861 Vol.	Functional and Performance Requirements for the National Airspace System General

### A.1.2 Standards

CSC-STD-002-85	Department of Defense (1985). <i>Department of Defense password management guideline</i> . Philadelphia, PA: Navy Publishing and Printing Office.
DOD-5200.28-STD	Department of Defense (1983). <i>Trusted computer system evaluation criteria</i> . Philadelphia, PA: Navy Publishing and Printing Office.
DOE-STAND HFAC1	Department of Energy (1992). <i>Human factors engineering design criteria</i> . Washington DC: U.S. Department of Energy.
FAA-STD-001B	Department of Transportation (1976). <i>Color and texture of finishes for national airspace system equipment</i> . Washington DC: Martin Marietta Air Traffic Systems.
FED-STD-595B	U.S. Government (1989). <i>Colors used in government procurement</i> . Washington DC: General Services Administration.

- MIL-STD-12D Department of Defense (1981). *Abbreviations for use on drawings and in specifications, standards and technical documents*. Philadelphia, PA: Navy Publishing and Printing Office.
- MIL-STD-454M Department of Defense (1989). *Standard general requirements for electronic equipment*. Philadelphia, PA: Navy Publishing and Printing Office.
- MIL-STD-490A Department of Defense (1985). *Specification practices*. Philadelphia, PA: Navy Publishing and Printing Office.
- MIL-STD-962B Department of Defense (1988). *Preparation of military standards, handbooks, and bulletins*. Philadelphia, PA: Navy Publishing and Printing Office.
- MIL-STD-1472D Department of Defense (1989). *Human engineering design criteria for military systems, equipment and facilities*. Philadelphia, PA: Navy Publishing and Printing Office.
- MIL-STD-1473 Department of Defense (1990). *Standard general requirements for color and marking of Army materiel*. Philadelphia, PA: Navy Publishing and Printing Office.
- MIL-STD-1800A Department of Defense (1990). *Human engineering performance requirements for systems*. Philadelphia, PA: Navy Publishing and Printing Office.
- MIL-STD-1801 Department of Defense (1987). *User/computer interface*. Philadelphia, PA: Navy Publishing and Printing Office.
- MIL-STD-1908 Department of Defense (1992). *Definitions of human factors terms*. Philadelphia, PA: Navy Publishing and Printing Office.
- NASA-STD-3000A NASA (1989). *Man-systems integration standards*. Houston, TX: NASA.
- NASA-STD-3000B NASA (1995, July). *Man-systems integration standards*. Houston, TX: NASA.



**A.1.3 Handbooks,  
manuals and guides**

ADAAG	Americans with Disabilities Act Accessibility Guidelines (Appendix B of the Americans with Disabilities Handbook)
EEOC-BK-19	Americans with Disabilities Act Handbook Equal Employment Opportunity Commission. Washington DC
AFSC DH 1-3	Department of the Air Force (1980). <i>Human factors engineering</i> . Wright- Patterson AFB, OH: ASD/ENESS.
DISA HCISG VI (Reference code from appendix B)	Keane, J. (1992). <i>Human computer interface style guide</i> (Version 1.0) (DTIC #A252410). Washington DC: Defense Information Systems Agency. (see also A.3)
DOD HCISG V2 (Reference code from appendix B)	Avery, L.W., & Bowser, S.E. (Eds.). (1992). <i>Department of Defense human- computer interface style guide</i> (Version 2.0) (DTIC #A252410). Washington DC: Defense Information Systems Agency. (see also A.3)
DOD-HDBK-743A	Department of Defense (1991). <i>Anthropometry of U.S. military personnel</i> . Philadelphia, PA: Navy Publishing and Printing Office.
DOD-5000.3-M-1	Department of Defense (1986). <i>Test and Evaluation Master Plan (TMP) Guidelines</i> . Philadelphia, PA: Navy Publishing and Printing Office.
DOE HFDG ATCCS V2.0 (Reference code from appendix B)	See DOD HCISG V2.
MIL-HDBK-759B	Department of Defense (1992). <i>Human factors engineering design for army materiel</i> . Philadelphia, PA: Navy Publishing and Printing Office.
MIL-HDBK-761A	Department of Defense (1989). <i>Human engineering guidelines for management information systems</i> . Philadelphia, PA: Navy Publishing and Printing Office.
NUREG-6105U.S.	Nuclear Regulatory Commission. (1994, September) <i>Guidance for the review</i>

	<i>of advanced alarm systems.</i> Washington DC: U.S. Nuclear Regulatory Commission.
NUREG-0700	U.S. Nuclear Regulatory Commission (1981). <i>Guidelines for control room design reviews.</i> Washington DC: U.S. Nuclear Regulatory Commission.
NUREG-0700 Rev.1	U.S. Nuclear Regulatory Commission (1995, February). <i>Human-system interface design review guidelines.</i> Washington DC: U.S. Nuclear Regulatory Commission.
UCRL-15673 (Reference code from appendix B)	Department of Energy (1985). <i>Human factors design guidelines for maintainability of department of energy nuclear facilities.</i> Washington DC: U.S. Department of Energy.

#### A.1.4 FAA Orders

FAA Order 1600.54B	Department of Transportation (1989). <i>FAA automated information systems security handbook.</i> Springfield, VA: National Technical Information Service.
FAA Order 1700.8D	Department of Transportation (1992). <i>Standards for preparing, printing, and distributing Federal Aviation Administration formal technical reports.</i> Springfield, VA: National Technical Information Service.
FAA Order 1810.1F	Department of Transportation (1993) <i>Acquisition Policy.</i> Springfield, VA: National Technical Information Service.
FAA Order 3900.19B	Department of Transportation (Draft) Occupational Safety and Health
FAA Order 9550.8	Department of Transportation (1993) <i>Human factors policy.</i> Springfield, VA: National Technical Information Service.

#### A.1.5 Federal Regulations

29 CFR 1910	Title 29 Part 1910 Occupational Health and Safety Standards
29 CFR 1926	Title 29 Part 1926 Safety and health regulations for construction

### A.1.6 Technical Reports

- AFHRL-TR-73-43(I) Joyce, R.P., Chenzoff, A.P., Mulligan, J.F., & Mallory, W.J. (1973). *Fully proceduralized job performance aids: draft military specification for organizational and intermediate maintenance*. Brooks Air Force Base, TX: Air Force Human Resources Laboratory. (See also A.3)
- ESD-TR-86-278 Smith, S.L., & Mosier, J.N. (1986). *Guidelines for designing user interface software*. Springfield, VA: National Technical Information Service. (See also A.3)
- NRDEC 54-84/034 Johnson, R.F. (1984). *Anthropometry of Clothing of US Army Ground Troops and Combat Vehicle Crewmen*. Natick, MA: U.S. Army Natick Research, Development, & Engineering. (See also A.3)
- NUREG/CR-5438 Fleishman, E.A., Buffardi, L.C., Allen, J.A., & Gaskins, R.C., III (1990). *Basic considerations in predicting error probabilities in human task performance*. Washington DC: U.S. Nuclear Regulatory Commission. (See also A.3)
- NUREG/CR-5534 Wells, J.E., Banks, W.W., Ryan, T.G., & Potash, L.M. (1991). *Task analysis linked evaluation technique (TALENT): Procedures for integrating human factors expertise into the probabilistic risk assessment process (Draft)*. Washington DC: U.S. Nuclear Regulatory Commission. (See also C.3)

### A.2 Institutional documents

- ASHRAE ASHRAE (Ed.) (1981). *Thermal environment conditions for human occupancy* (ANSI-ASHRAE Standard 55). Atlanta, GA: American Society of Heating, Refrigerating, and Air-Conditioning Engineers.

- EPRI Electric Power Research Institute (1984). *Human factors guide for nuclear power plant control room development* (EPRI NP-3659). Palo Alto, CA: Research Reports Center.
- IEEE Institute of Electrical and Electronics Engineers, Inc. (1989). *A guide for general principles of human action reliability analysis for nuclear power generation stations (Draft)*. New York, NY: IEEE.
- OSF Open look: *Graphical user interface application style guidelines* (1990). Reading, MA: Addison-Wesley.

### A.3 Documents identified by author

Angiolillo, J.S., & Roberts, L.A. (1991). What makes a manual look easy to use? *Proceedings of the Human Factors Society 35th Annual Meeting* (pp. 222-224). Santa Monica, CA: Human Factors Society.

Avery, L.W., & Bowser, S.E. (Eds.). (1992). *Department of Defense human-computer interface style guide (Version 2.0)* (DTIC #A252410). Washington DC: Defense Information Systems Agency. (see also C.1.3)

Benel, D.C. (1988). Access to electronic office equipment by users with disabilities. In *Proceedings of the Human Factors Society 32nd Annual Meeting* (pp. 271-272). Santa Monica, CA: Human Factors and Ergonomics Society.

Billings, C.E. (1991, August) *Human-centered automation: a concept and guidelines*. NASA Technical Memorandum 103885. . Ames Research Center, Moffett Field, CA: National Aeronautics and Space Administration

Boff, K.R., & Lincoln, J.E. (1988). *Engineering data compendium: Human perception and performance*. Wright-Patterson Air Force Base, OH: AAMRL.

Bond, N.A., Jr (1987). Maintainability. In G. Salvendy (Ed.), *Handbook of Human Factors* (pp. 1328-1355). New York, NY: Wiley.

Briscoe, G.J. (1982). *Risk management guide*. Idaho Falls, ID: EG&G Idaho.  
Collins, E.P., & McFadden, R.H. (1988). A human reliability analysis methodology for industrial and process facilities. *Industrial and Commercial Power Systems Technical Conference*, 81-84.

Casali, S.P. (1992). Cursor control device use by persons with physical disabilities: Implications for hardware and software design. In *Proceedings of the Human Factors Society 36th Annual Meeting* (pp. 311-315). Santa Monica, CA: Human Factors and Ergonomics Society.

Cooper, M.B., Darglish, H.N., & Adams, J.A. (1979). Reader preference for report typefaces. *Applied Ergonomics*, 10.2, (pp. 66-70).

Department of Transportation (1990). *Capital investment plan*. Washington DC: Martin Marietta Air Traffic.

Edwards, A.D.N. (1988). The design of auditory interfaces for visually disabled users. In *Proceedings of CHI'88 Conference on Human-Computer Interaction* (pp. 83-88). New York, NY: Association for Computing Machinery.

Endsley, Mica R. (1995) Toward a theory of situation awareness in dynamic systems. *Human Factors*.37 (1) 32 - 64.

Endsley, Mica R. (1995) Measurement of situation awareness in dynamic systems. *Human Factors*.37 (1) 65 - 84.

Farrell, R.J., & Booth, J.M. (1975). *Design handbook for imagery interpretation equipment*. Seattle, WA: Boeing Aerospace Company.

Fernandes, K., (1992). *User interface specifications for Navy command and control systems (Version 1.2)*. San Diego, CA: NCCOSC, RDT&E Division.

Fleishman, E.A., Buffardi, L.C., Allen, J.A., & Gaskins, R.C., III (1990). *Basic considerations in predicting error probabilities in human task performance*. Washington DC: U.S. Nuclear Regulatory Commission. (See also A.3)

Gribbons, W.M. (1992). Organization by design: Some implications for structuring information. In *Technical Writing and Communication*, 22, (pp. 57-75).

Hartley, J. (1978). *Designing instructional text*. New York, NY: Nichols.

Hoecker, D.G. (1991). *Maintenance information for power plants and airplanes: Shared implications for design of human-computer interaction*. (Report No. 90-9S24-HFIMI-R1). Pittsburgh, PA: Westinghouse STC.

Houghton-Alico, D. (1985). *Creating computer software user guides: From manuals to menus*. New York, NY: McGraw-Hill.

Israelski, E.W. (1977). *Human factors handbook for telecommunications product design*. Whippany, NJ: AT&T Bell Laboratories.

Johnson, R.F. (1984). *Anthropometry of Clothing of US Army Ground Troops and Combat Vehicle Crewmen*. Natick, MA: U.S. Army Natick Research, Development, & Engineering. (See also A.1.5)

Joyce, R.P., Chenzoff, A.P., Mulligan, J.F., & Mallory, W.J. (1973). *Fully proceduralized job performance aids: draft military specification for organizational and intermediate maintenance*. Brooks Air Force Base, TX: Air Force Human Resources Laboratory. (See also A.1.5)

Kanis, H. (1988). Design for all? The use of consumer products by the physically disabled. In *Proceedings of the Human Factors Society 32nd Annual Meeting* (pp. 416-419). Santa Monica, CA: Human Factors and Ergonomics Society.

Kanis, H. (1993). Operation of controls on consumer products by physically impaired users. *Human Factors*, 35, (pp. 305-328).

Keane, J. (1992). *Human computer interface style guide (Version 1.0)* (DTIC #A252410). Washington DC: Defense Information Systems Agency. (see also A.1.5)

Kroemer, K.H.E., Kroemer, H.J., & Kroemer-Elbert, K.E. (1990). *Engineering physiology: Bases of human factors/ergonomics*. New York, NY: Van Nostrand Reinhold.

Kroemer, K.H.E. (1987) Biomechanics of the human body .In G. Salvendy (Ed.), *Handbook of Human Factors* (pp. 154 - 181). New York, NY: Wiley.

Ladner, R.E. (1988). Public Law 99-506, "Section 508" Electronic equipment accessibility for disabled workers [Panel discussion]. In *Proceedings of CHI'88 Conference on Human-Computer Interaction* (pp. 219-222). New York, NY: Association for Computing Machinery.

Lee, K.W., Tillman, F.A., & Higgins, J.J. (1988). A literature survey of the human reliability component in a man-machine system. *IEEE Transactions on Reliability*, 37(1), 24-34.

Mynatt, E.D., & Edwards, W.K. (1992). Mapping GUIs to auditory interfaces. In *Proceedings of the ACM Symposium on User Interface Software and Technology* (pp. 61-70). New York, NY: Association for Computing Machinery.

Newell, A.F., & Cairns, A.Y. (1993). Designing for extraordinary users. *Ergonomics in Design*, October (pp.10-16).

Rasmussen, J. (1981). Models of mental strategies in process plant diagnosis. J. Rasmussen & W.B. Rouse (Eds.), *Human Detection and Diagnosis of System Failures*. New York, NY: Plenum Press.

Rasmussen, J. (1986). *Information processing and human-machine interaction*. New York, NY: Elsevier Science.

Roebuck, J.A., Kroemer, K.H.E., & Thomson, W.G. (1975). *Engineering anthropometry methods*. New York, NY: Wiley.

Rouse, W.B., & Morris, N.M. (1985). Understanding and avoiding potential problems in implementing automation. *IEEE International Conference on Systems, Man, & Cybernetics*, 3, 787-791.

Rubens, P. (1992). *Science and technical writing: A manual of style*. New York, NY: Holt.

Scadden, L.A., & Vanderheiden, G.C. (1988). *Considerations in the design of computers and operating systems to increase their accessibility to persons with disabilities*. Version 4.2. Madison, WI: Trace R&D Center.

Sheridan, T.B., & Johannsen, G. (Eds.). (1976). *Monitoring behavior and supervisory control*. New York, NY: Plenum Press.

Sheridan, T.B. (1987). Supervisory Control. In G. Salvendy (Ed.), *Handbook of Human Factors* (pp. 1243-1267). New York, NY: Wiley.

Simpson, H., & Casey, S.M. (1988). *Developing effective user documentation*. New York, NY: McGraw-Hill.

Smith, S.L., & Mosier, J.N. (1986). *Guidelines for designing user interface software*. Springfield, VA: National Technical Information Service. (See also A.1.5)

Snook, S.H., Ciriello, V.M. (1991) The design of manual handling tasks: revised tables of maximum acceptable weights and forces. *Ergonomics*.34 (9): 1197 -1213

Spyridakis, J.H., & Wenger, M.J. (1992). Writing for human performance: Relating reading research to document design. *Technical Communications*, 39, (pp. 202-215).

United States Government Printing Office (1984). *Style manual*. Washington DC: U.S. Government Printing Office.

VanCott, H.P., & Kinkade, R.G. (1972). *Human engineering guide to equipment design*. Washington DC: U.S. Government Printing Office.



Vanderheiden, G.C. (1990). Thirty-something million: Should they be exceptions? *Human Factors*, 32, (pp. 383-396).

Vanderheiden, G.C., & Vanderheiden, K.R. (1991). *Accessible design of consumer products: Guidelines for the design of consumer products to increase their accessibility to people with disabilities or who are aging*. Working draft 1.6. Madison, WI: Trace R&D Center.

Waters, T.R., Put-Anderson, V., Gag, A. Fine, L. (1993). Revised NOSH equations for the design and evaluation of manual lifting tasks. *Ergonomics* 36 (7) 749 - 776.

Wells, J.E., Banks, W.W., Ryan, T.G., & Potash, L.M. (1991). *Task analysis linked evaluation technique (TALENT): Procedures for integrating human factors expertise into the probabilistic risk assessment process (Draft)*. Washington DC: U.S. Nuclear Regulatory Commission (see also A.1.5).

Wickens, C.D. (1992). *Engineering psychology and human performance* (2nd ed.). New York, NY: HarperCollins.

Wieringa, D., Moore, C., & Barnes, V. (1993). *Procedure Writing: Principles and Practices*. Columbus, OH: Battelle Press.

Wilhelmsen, C.A., Gertman, D.I., Ostrom, L.T., Nelson, W.R., Galyean, W.J., & Byers, J.C. (1992). *Reviewing the impact of advanced control room technology*. (Report No. EGG-M-91550). Idaho Falls, ID: EG&G Idaho.

Williams, T.R., & Spyridakis, J.H. (1992). Visual discriminability of headings in text. *IEEE Transactions on Professional Communication*, 35, (pp. 64-70).

Woods, D.D., O'Brien, J.F., & Hanes, L.F. (1987). Human Factors Challenges in Process Control: The Case of Nuclear Power Plants. In G. Salvendy (Ed.), *Handbook of Human Factors* (pp. 1724-1770). New York, NY: Wiley.

Wyszecki, G. and Stiles, W. S. (1967). *Color Science Concepts and Methods, Quantitative Data and Formulas* (pp 235-238). New York, NY: Wiley

Zaneski, R. (1982). *Software manual production simplified*. New York, NY: Petrocelli.

## Appendix B Sources

This appendix identifies by section and paragraph, the sources of reference information used to develop this HFDG. Most of the sources were government documents or work done for the government. In most cases, the authors interpreted the source concepts and tailored the current guide's rules for application in the FAA environment. Thus, sources can be considered professional references that contain supportive information. To save space, the sources are abbreviated in this listing, but include enough information to permit identification by readers familiar with them. The abbreviations are completely spelled out in Appendix A, References. Exhibits in this appendix are identified with an "E."

The current version of the guide's technical sections was recently reviewed by thirty-five subject matter experts (SMEs) who provided comments to sections or components related to their area of expertise. The authors used their best judgements and interpretation in selecting and incorporating their comments. The authors treated the SME concerns within practical, professional, and administrative constraints. The effort of the SMEs was greatly appreciated and did improve the document. What was incorporated and how it was said was again based upon judgements of the document's authors. An assigned number for each SME who contributed comments to a certain section is listed as the first entry in each major section below. Individual names for section reviewers have been retained by the sponsoring office, ACT-530, Human Factors Branch, at the FAA Technical Center, Atlantic City, New Jersey.

- |   |   |
|---|---|
| <p><b>Foreword</b> FAA Order 9550.8;<br/>FAA Order 1810.1F;<br/>The National Plan for Aviation<br/>Human Factors (Draft) 1990</p> <p><b>1</b> SMEs 1, 2, 7, 21, 24, 25; New</p> <p><b>1.1</b> New<br/><b>1.2</b> New<br/><b>1.3</b> New<br/><b>1.3.1</b> New<br/><b>1.3.2</b> MIL-STD-1472D, 4.2; NDI &amp;<br/>COTS see 3 Definitions<br/>FAA-G-2100F<br/><b>1.4</b> New<br/><b>1.4.1.1</b> FAA Order 9550.8; 29 CFR1910<br/>&amp; 29 CFR1926 (OSHA);<br/>FAA3900.19B; 29 CFR 35,<br/>36,1630 (ADA)<br/><b>1.4.1.2</b> FED-STD-376<br/><b>1.4.1.3</b> New<br/><b>1.4.2</b> New<br/><b>E1.4.2.4</b> New</p> <p><b>2</b> SMEs 1, 2</p> <p><b>3</b> SMEs 1, 2</p> <p><b>4</b> SMEs 1, 2, 21, 24, 25</p> <p><b>4.1.1</b> NASA-STD-3000A, 2.3.1; MIL-<br/>STD-1472D, 4.6<br/><b>4.1.2</b> NASA-STD-3000A, 2.3.2; MIL-<br/>STD-1472D, 4.2<br/><b>4.1.3</b> NASA-STD-3000A, 2.3.2</p> | <p><b>4.1.4</b> MIL-STD-1472D, 4.2; MIL-<br/>HDBK-759B, 4.3; NASA-STD-<br/>3000A, 2.1, 2.2.2<br/><b>4.1.5</b> UCRL-15673, 1.2.3.3e, 1.2.3.3f;<br/>MIL-STD-1472D, 5.8.1.8<br/><b>4.1.6</b> MIL-HDBK-759B, 5.6.4.2; MIL-<br/>STD-1472D, 5.9.1.2; NASA-<br/>STD-3000A, 1.2.3.1.1g<br/><b>4.1.7</b> NASA-STD-3000A, 2.3; MIL-<br/>STD-1472D, 4.5; DOE-STAND<br/>HFAC 1, 1.4<br/><b>4.1.8</b> MIL-STD-1472D, 4.5<br/><b>4.1.9</b> DOE-STAND HFAC 1, 1.8; MIL-<br/>STD-1472D, 4.9<br/><b>4.2.1</b> MIL-HDBK-759B, 4.2; MIL-STD-<br/>1472D, 1.4; DOE-STAND HFAC<br/>1, 1.3<br/><b>4.2.2</b> New<br/><b>4.2.3</b> MIL-HDBK-759B, 4.2<br/><b>4.2.4</b> MIL-HDBK-759B, 4.2<br/><b>4.3.1</b> MIL-HDBK-759B, 4.5; MIL-STD-<br/>1472D, 4.3<br/><b>4.3.2</b> DOE-STAND HFAC 1, 1.9<br/><b>4.3.3</b> NASA-STD-3000A, 2.3<br/><b>4.3.4</b> MIL-STD-1472D, 4.7<br/><b>4.3.5</b> DOE-STAND HFAC 1, Intro. p1</p> <p><b>5</b> SMEs 3, 4, 5, 6, 24, 25; FAA<br/>Capital investment plan,<br/>1-0-27 &amp; 28, 1990</p> <p><b>5.1.1</b> NUREG-700, Rev 1, -A-2<br/><b>5.1.2</b> NUREG-700, A-3; NUREG-6105,<br/>A-2<br/><b>5.1.3</b> NUREG-700, Rev 1, A-1<br/><b>5.1.4</b> NUREG-700, Rev 1, A-2;<br/>Endsley, 1995</p> |
|---|---|

- 5.1.5 NUREG-700, Rev 1 A-2 & A-3
- 5.2 Billings, 1991
- 5.2.1 Woods telephone and correspondence, Billings, 1991
- 5.2.2 Billings, 1991, 81
- 5.2.3 Billings, 1991, 82
- 5.2.4 Billings, 1991, 82 & 87
- 5.2.5 Billings, 1991, 85
- 5.2.6 Billings, 1991, 88
- 5.2.7 Billings, 1991, 82
- 5.2.8 Billings, 1991, 48 & 83
- 5.2.9 Billings, 1991, 85
- 5.2.10 Billings, 1991, 85
- 5.2.11 New
- 5.2.12 New
- 5.2.13 New
- 5.2.14 New
- 5.2.15 Billings, 1991, 85, 86, & 90
- 5.2.16 Billings, 1991, 86
- 5.2.17 Billings, 1991, 91
- 5.2.18 Billings, 1991, 88
- 5.2.19 Billings, 1991, 90
- 5.2.20 Billings, 1991, 88
- 5.2.21 New
- 5.2.22 NEUREG-700 Rev 1 5-1 - 5-3
- 5.3 Salvendi 1989 - Sheridan 1243 - 1267
- 5.3.1 Billings 1991
- 5.3.2 New
- 5.3.3 - 5.3.7 New
- 5.4 New
- 5.5 New
- 5.6 New
- 5.7 New
- 5.8.1 - 5.8.9 New
- 5.8.10 NUREG-700 Rev 1, 4.1-1, 4.3-12, 4.4-1 & 4.4-2; Billingsley 1991, 88; FAA Order 6000-15B 81 a,b,c
- 5.8.11 New
- 5.8.12 NUREG-700 Rev 1, 4.3-1, -3, -4, -6, -7, -9, & -10; 4.4-4
- 5.8.13 NUREG-700 Rev 1, 4.5.1-1, 4.5.5.1-2, -3, -5, -6, -7, -8; 4.1-3, -4;
- 5.8.14 NUREG-700 Rev 1, 4.8.-1 & -2
- 5.9 New
- 5.10.1 New
- 5.10.2 New
- 5.10.3 Billings, 1991, 85
- 5.10.4 New
- 5.10.5 New
- 6 SMEs 5, 21, 22, 23, 24
- 6.1.1.1 MIL-HDBK-759B, 5.6.1.2.2
- 6.1.1.2 NASA-STD-3000A, 12.3.1.1i
- 6.1.1.3 NASA-STD-3000A, 12.3.1.1b
- 6.1.1.4 NASA-STD-3000A, 12.3.1.1j
- 6.1.1.5 NASA-STD-3000A, 12.2.e.4
- 6.1.1.6 NASA-STD-3000A, 12.3.1.1b
- 6.1.1.7 NASA-STD-3000A, 12.3.1.1h
- 6.1.1.8 AFSC DH 1-3, DN 2G3
- 6.1.1.9 MIL-STD-1472D, 5.9.3
- 6.1.1.10 NASA-STD-3000A, 12.3.1.4i
- 6.1.3.1 AFSC DH 1-3, DN 2G3; MIL-STD-1472D, 5.9.1.1
- 6.1.3.2 AFSC DH 1-3, DN 2G3; MIL-STD-1472D, 5.9.1.1; UCRL-15673, 1.2.3.3e
- 6.1.3.3 MIL-HDBK-759B, 5.6.18.14c
- 6.1.3.4 NASA-STD-3000A, 12.3.1.1g
- 6.1.3.5 AFSC DH 1-3, DN 2G1
- 6.1.3.6 MIL-STD-1472D, 5.9.1.2; MIL-STD-1800A, 4.3.1
- 6.1.4.1 NASA-STD-3000A, 12.3.1.1r
- 6.1.4.2 NASA-STD-3000A, 12.2.d.1, 12.2.1.d.2
- 6.1.5.1 AFSC DH 1-3, DN 2N 2G1
- 6.1.5.2 NASA-STD-3000A, 12.2.d.3
- 6.2.1.2 MIL-STD-1800A, 4.3.8
- 6.2.1.3 MIL-STD-1472D, 5.9.1.3, 5.9.1.6
- 6.2.2.1 MIL-HDBK-759B, 5.3.4.4; MIL-STD-1472D, 5.9.11.3.1, 5.9.11.3.3
- 6.2.2.2 MIL-STD-1472D, 5.9.11.3.4
- 6.2.2.3 MIL-STD-1472D, 5.9.11.3.1
- 6.2.2.4 MIL-STD-1472D, 5.9.11.3.1
- 6.2.2.5 MIL-STD-1472D, 5.9.11.3.1
- 6.2.2.6 MIL-STD-1472D, 5.9.11.3.5
- 6.2.2.7 MIL-STD-1472D, 5.9.11.3.5
- 6.2.2.8 AFSC DH 1-3, DN 2G3; MIL-HDBK-759B, 5.6.13.4; MIL-STD-1800A, 4.3.18.3
- 6.2.2.9 AFSC DH 1-3, DN 2G3
- 6.2.2.10 MIL-STD-1800A, 4.3.18.3
- 6.2.3.1 AFSC DH 1-3, DN 2G3
- 6.2.3.2 AFSC DH 1-3, DN 2G3
- 6.2.4.1 MIL-STD-1472D, 5.9.11.2
- 6.2.4.2 MIL-STD-1472D, 5.9.11.2; MIL-STD-1800A, 4.3.18.2
- 6.2.5 UCRL-15673, 1.13.3.1
- 6.2.5.1.1 MIL-HDBK-759B, 5.6.19.2.t; MIL-STD-1800A, 4.3.18.4.1
- 6.2.5.1.2 AFSC DH 1-3, DN 2G3; MIL-HDBK-759B, 5.6.19.2.t
- 6.2.5.1.3 AFSC DH 1-3, DN 2G3; UCRL-15673, 1.13.3.3.e
- 6.2.5.1.4 AFSC DH 1-3, DN 2G3; UCRL-15673, 1.13.3.3.e
- 6.2.5.1.5 MIL-STD-1472D, 5.9.11.5.6
- 6.2.5.2.1 AFSC DH 1-3, DN 2G3; MIL-HDBK-759B, 5.6.13.4; UCRL-15673, 1.13.3.3.f
- 6.2.5.2.2 MIL-STD-1472D, 5.9.11.5.7
- 6.2.5.2.3 MIL-STD-1472D, 5.9.11.5.7
- 6.2.5.2.4 MIL-HDBK-759B, 5.6.13.4
- 6.2.5.2.6 AFSC DH 1-3, DN 2G3; MIL-STD-1800A, 4.3.18.4.3; MIL-STD-1472D, 5.9.11.5.3
- 6.2.5.3 MIL-HDBK-759B, 5.6.13.2
- 6.2.5.3.1 MIL-HDBK-759B, 5.6.13.2; MIL-STD-1472D, 5.9.11.5.5; UCRL-15673, 1.13.3.2
- E6.2.5.3.1 MIL-HDBK-759B, 5.6.13.2; MIL-STD-1472D, & MIL-STD-1472B, 5.9.11.5.5; UCRL-15673, 1.13.3.2
- 6.2.5.3.2 AFSC DH 1-3, DN 2G3, 2.4.3; MIL-STD-1472D, 5.9.11.5.5
- 6.2.5.3.3 MIL-STD-1472D, 5.9.11.5.5

- 6.2.5.4.1** MIL-STD-1472D, 5.9.11.5.2; UCRL-15673, 1.13.3.3.b
- 6.2.5.4.2** MIL-STD-1472D, 5.9.11.5.2; UCRL-15673, 1.13.3.3.b
- 6.2.5.4.3** MIL-STD-1800A, 4.3.18.4.6
- 6.2.5.4.4** MIL-STD-1472D, 5.9.11.5.2
- 6.2.6.1** MIL-STD-1472D, 5.9.11.5.2; MIL-STD-1800A, 4.3.18.4.2
- 6.2.6.2** AFSC DH 1-3, DN 2G3; MIL-STD-1472D, 5.9.11.5.4; MIL-STD-1800A, 4.3.18.4.4
- 6.2.6.3** MIL-STD-1472D, 5.9.11.5.7; MIL-STD-1800A, 4.3.18.4.6
- 6.2.6.4** MIL-STD-1472D, 5.9.11.5.7
- 6.2.7.1** AFSC DH 1-3, DN 2G3; MIL-STD-1472D, 5.9.11.1; MIL-STD-1800A, 4.3.18.1
- 6.2.7.2** AFSC DH 1-3, DN 2G3; MIL-STD-1472D, 5.9.11.1; MIL-STD-1800A, 4.3.18.1
- 6.2.7.3** AFSC DH 1-3, DN 2G3
- 6.2.8.1** MIL-STD-1472D, 5.8.7.4
- 6.2.8.2** AFSC DH 1-3, DN 2G3, 2.1.1.f; MIL-HDBK-759B, 5.6.18.4.1; MIL-STD-1472D, 5.8.1.8, 5.9.12.4, 5.9.14.10; MIL-STD-1800A, 4.3.19.1; NASA-STD-3000A, 12.3.1.4.j
- 6.2.8.3** MIL-HDBK-759B, 5.6.18.4.2,
- 6.2.8.4** MIL-HDBK-759B, 5.6.19.2.f
- 6.2.8.5** MIL-STD-1472D, 5.9.12.5
- 6.2.8.6** AFSC DH 1-3, DN 2G3; UCRL 15673, 1.4.3.12
- 6.2.9.1** MIL-STD-1800A, 4.3.26.1.1
- 6.2.9.2** MIL-STD-1800A, 4.3.26.1.2
- 6.2.9.3** MIL-STD-1800A, 4.3.26.1.3
- 6.2.9.4** MIL-STD-1800A, 4.3.26.1.4
- 6.2.10.1** AFSC DH 1-3, DN 2G3; MIL-HDBK-759B, 5.6.13.4; MIL-STD-1800A, 4.3.18.3
- 6.2.10.2** MIL-STD-1472D, 5.9.11.5.2
- 6.2.10.3** MIL-HDBK-759B, 5.6.15.2.5; MIL-STD-1800A, 4.3.18.3
- 6.3.1.1** UCRL-15673, 1.1.3.1.g
- 6.3.1.2** AFSC DH 1-3, DN 2G1; MIL-STD-1472D, 5.9.1.3; UCRL-15673, 1.1.3.1.d
- 6.3.1.3** MIL-HDBK-759B, 5.6.19.2.k
- 6.3.1.4** AFSC DH 1-3, DN 2G3; UCRL-15673, 1.1.3.1.e & 1.1.3.1.k
- 6.3.1.5** UCRL-15673, 1.1.3.1.i
- 6.3.1.6** AFSC DH 1-3, DN 2G3
- 6.3.1.7** AFSC DH 1-3, DN 2G3
- 6.3.1.8** MIL-HDBK-759B, 5.6.19.2.a
- 6.3.2.1** UCRL-15673, 1.2.3.3.e
- 6.3.2.2** MIL-STD-1472D, 5.8.1.8
- 6.3.2.3** MIL-STD-1472D, 5.8.1.8; UCRL-15673, 1.2.3.3.f
- 6.3.2.4** UCRL-15673, 1.2.3.3.f
- 6.3.3.1.1** AFSC DH 1-3, DN 2G3; MIL-STD-1472D, 5.9.12.6
- 6.3.3.1.2** MIL-HDBK-759B, 5.6.18.7.f & 5.6.19.2.j
- 6.3.3.1.3** AFSC DH 1-3, DN 2G4 2.4.a; MIL-HDBK-759B, 5.6.18.12; MIL-STD-1800A, 4.3.10.4
- 6.3.3.1.4** MIL-STD-1472D, 5.9.12.6; MIL-STD-1800A, 4.3.19.4
- 6.3.3.1.5** UCRL-15673, 1.2.3.3.b
- 6.3.3.1.6** UCRL-15673, 1.12.3.1
- 6.3.3.1.7** UCRL-15673, 1.12.3.2-4
- 6.3.3.1.8** UCRL-15673, 1.12.3.7
- 6.3.3.2.1** AFSC DH 1-3, DN 2G3; MIL-HDBK-759B, 5.6.19.2.j; MIL-STD-1472D, 5.9.12.7; MIL-STD-1800A, 4.3.19.5; NASA-STD-3000A, 12.3.1.2.q
- 6.3.3.2.2** MIL-STD-1472D, 5.9.12.7; UCRL-15673, 1.12.3.4
- 6.3.3.2.3** AFSC DH 1-3, DN 2G3; MIL-STD-1472D, 5.9.12.7; MIL-STD-1800A, 4.3.19.5; NASA-STD-3000A, 12.3.1.2.q
- 6.3.3.2.4** AFSC DH 1-3, DN 2G3; MIL-STD-1472D, 5.9.12.9; MIL-STD-1800A, 4.3.19.7
- 6.3.3.3.1** UCRL-15673, 1.12.3.6
- 6.3.3.3.2** MIL-STD-1472D, 5.9.12.8; MIL-STD-1800A, 4.3.19.6
- 6.3.3.3.3** MIL-STD-1472D, 5.9.14.10
- 6.3.4.1.1** MIL-HDBK-759B, 5.6.18.7; MIL-STD-1472D, 5.9.4.1, 5.9.4.4, 5.9.8.3, 5.9.10.6, 5.9.14.9, MIL-STD-1800A, 4.3.21.9; NASA-STD-3000A, 12.3.1.2.i, 12.3.1.2.j, 12.3.2.2.j
- 6.3.4.1.2** MIL-HDBK-759B, 5.6.18.7; MIL-STD-1472D, 5.9.4.1, 5.9.8.3; MIL-STD-1800A, 4.3.10.2; UCRL-15673, 1.2.3.1.1
- 6.3.4.1.3** MIL-HDBK-759B, 5.6.18.7; MIL-STD-1472D, 5.9.4.3; NASA-STD-3000A, 12.3.1.2.j
- 6.3.4.1.4** AFSC DH 1-3, DN 2G4, 2.4.b
- 6.3.4.1.5** AFSC DH 1-3, DN 2G4, 2.3.a; MIL-HDBK-759B, 5.6.20.1; MIL-STD-1800A, 4.3.10.3; NASA-STD-3000A, 12.3.1.2.d; UCRL-15673, 1.2.3.1.k
- 6.3.4.1.6** MIL-STD-1472D, 5.9.4.4; NASA-STD-3000A, 12.3.1.2.u
- 6.3.4.1.7** AFSC DH 1-3, DN 2G4, 2.2; MIL-HDBK-759B, 5.6.18.7; UCRL-15673, 1.2.3.1.n
- 6.3.4.1.8** AFSC DH 1-3, DN 2G4, 2.4.C; MIL-HDBK-759B, 5.6.20.1
- 6.3.4.1.9** AFSC DH 1-3, DN 2G4, 2.3.f; MIL-STD-1472D, 5.9.12.3
- 6.3.4.2.1** MIL-STD-1472D, 5.9.4.5; NASA-STD-3000A, 12.3.1.2.a
- 6.3.4.2.2** AFSC DH 1-3, DN 2G4, 2.3.b; MIL-HDBK-759B, 5.6.20.1; MIL-STD-1472D, 5.9.4.5; NASA-STD-3000A, 12.3.1.2.a; UCRL-15673, 1.2.3.1.i
- 6.3.4.2.3** AFSC DH 1-3, DN 2G4, 2.4.e; MIL-HDBK-759B, 5.6.20.1; MIL-STD-1472D, 5.9.12.10
- 6.3.4.2.4** MIL-STD-1472D, 5.9.4.7; MIL-STD-1800A, 4.3.10.6
- 6.3.4.2.5** MIL-STD-1472D, 5.9.4.2; MIL-STD-1800A, 4.3.10.3
- 6.3.4.2.6** NASA-STD-3000A, 12.3.4.1.c

- 6.3.5.1.1** UCRL-15673, 1.3.3.8  
**6.3.5.1.2** MIL-HDBK-759B, 5.6.18.6.1  
**6.3.5.1.3** MIL-HDBK-759B, 5.6.18.6.1;  
MIL-STD-1800A, 4.3.18.3  
**6.3.5.1.4** UCRL-15673, 1.3.3.1  
**6.3.5.1.5** UCRL-15673, 1.3.2, 1.2.3.2.b  
**6.3.5.2.1** UCRL-15673, 1.3.4.2.c  
**6.3.5.2.2** UCRL-15673, 1.3.4.3.e  
**6.3.5.2.3** UCRL-15673, 1.3.4.3.e.2  
**6.3.5.2.4** UCRL-15673, 1.3.4.3.d.2  
**6.3.5.3.1** UCRL-15673, 1.3.4.3.c  
**6.3.5.3.2** UCRL-15673, 1.3.4.3.c.7  
**6.3.5.3.3** UCRL-15673, 1.3.4.3.c.8  
**6.3.5.3.4** UCRL-15673, 1.3.4.3.c.4,  
1.3.4.3.c.5  
**6.3.5.3.5** UCRL-15673, 1.3.4.3.c.9  
**6.3.5.3.6** UCRL-15673, 1.3.4.3.c.10  
**6.3.5.3.7** UCRL-15673, 1.3.4.3.c.11  
**6.3.5.3.8** UCRL-15673, 1.3.4.3.c.3  
**6.3.5.3.9** UCRL-15673, 1.3.4.2.b,  
1.3.4.3.c.1  
**6.3.5.4.1** UCRL-15673, 1.3.4.3.d.3  
**6.3.5.4.2** UCRL-15673, 1.3.4.3.d.1,  
1.3.4.3.d.6  
**6.3.5.4.3** UCRL-15673, 1.3.4.d.2  
**6.3.5.5.1** UCRL-15673, 1.3.3.12  
**6.3.5.5.2** UCRL-15673, 1.3.3.12,  
1.3.4.3.c.2  
**6.3.5.5.3** UCRL-15673, 1.3.4.3.d.5  
**E6.3.5.5.3** UCRL-15673, 1.3.4.3.d.5  
**6.4.1.1** AFSC DH 1-3, DN 2G3; MIL-  
STD-1472D, 5.9.9.1; MIL-STD-  
1800A, 4.3.15; UCRL-15673,  
1.4.3.1  
**6.4.1.2** NASA-STD-3000A, 12.3.1.2.g;  
UCRL-15673, 1.4.4.1.b  
**6.4.1.3** AFSC DH 1-3, DN 2G3; MIL-  
HDBK-759B, 5.6.7.3; MIL-STD-  
1472D, 5.9.9.4; MIL-STD-1800A,  
4.3.10.1; NASA-STD-3000A,  
12.3.1.2.h  
**6.4.1.4** MIL-HDBK-759B, 5.6.8.2; MIL-  
STD-1472D, 5.9.9.5.1.6; UCRL-  
15673, 1.4.3.15  
**6.4.1.5** MIL-HDBK-759B, 5.6.8.2  
**6.4.2.1** MIL-HDBK-759B, 5.6.5.4; MIL-  
STD-1472D, 5.9.9.5.1; MIL-STD-  
1800A, 4.3.16; NASA-STD-  
3000A, 12.3.1.3.b; UCRL-15673,  
1.4.4.1.b, 1.4.4.4.g  
**6.4.2.2** MIL-HDBK-759B, 5.6.7.2;  
UCRL-15673, 1.4.3.7  
**6.4.2.3** MIL-STD-1472D, 5.9.9.5.1  
**6.4.3.2** MIL-STD-1472D, 5.9.9.5.1.2  
**E6.4.3.2** Proposed MIL-STD-1472D,  
5.9.9.4.1; MIL-STD-1472D,  
5.9.9.5.1.2; AFSC DH 1-3, DN  
2G3, 4.2  
**6.4.3.3** MIL-STD-1472D, 5.9.9.5.1.2  
**E6.4.3.3** Proposed MIL-STD-1472D,  
5.9.9.4.1; MIL-STD-1472D,  
5.9.9.5.1.2; AFSC DH 1-3, DN  
2G3, 4.2  
**6.4.3.4** MIL-STD-1472D, 5.9.9.5.1.2  
**E6.4.3.4** Proposed MIL-STD-1472D,  
5.9.9.4.1; MIL-STD-1472D,  
5.9.9.5.1.2; AFSC DH 1-3, DN  
2G3, 4.2  
**6.4.4.1** AFSC DH 1-3, DN 2G3; MIL-  
HDBK-759B, 5.6.8.3; MIL-STD-  
1472D, 5.9.9.5.1.2; NASA-STD-  
3000A, 12.3.1.2.f; UCRL-15673,  
1.4.4.2.a  
**6.4.5.1** MIL-HDBK-759B, 5.6.8.5;  
UCRL-15673, 1.4.4.3.a  
**6.4.5.2** MIL-HDBK-759B, 5.6.8.5;  
UCRL-15673, 1.4.4.3.a;  
**6.4.5.3** MIL-HDBK-759B, 5.6.8.5;  
UCRL-15673, 1.4.4.3.a  
**6.4.5.4** MIL-HDBK-759B, 5.6.8.5; MIL-  
STD-1472D, 5.9.9.6; UCRL-  
15673, 1.4.4.3.a  
**6.4.5.5** MIL-HDBK-759B, 5.6.8.5;  
UCRL-15673, 1.4.4.3.a  
**6.4.5.6** UCRL-15673, 1.4.4.3.a  
**6.4.5.7** MIL-HDBK-759B, 5.6.7.1;  
UCRL-15673, 1.4.3.5  
**6.4.5.8** MIL-HDBK-759B, 5.6.3.4.1.2.d.2  
**6.4.6.1** AFSC DH 1-3, DN 2G3; UCRL-  
15673, 1.4.3.13  
**6.4.6.2** AFSC DH 1-3, DN 2G3; MIL-  
STD-1472D, 5.9.9.3; UCRL-  
15673, 1.4.3.14  
**6.4.6.3** AFSC DH 1-3; MIL-STD-1472D,  
5.9.9.3; UCRL-15673, 1.4.4.4.d  
**6.4.6.4** AFSC DH 1-3, DN 2G3; UCRL-  
15673, 1.4.3.12  
**6.5.1.1** AFSC DH 1-3, DN 2G3  
**6.5.1.2** AFSC DH 1-3, DN 2G3; UCRL-  
15673, 1.10.3.2  
**6.5.1.3** AFSC DH 1-3, DN 2G3; MIL-  
STD-1472D, 5.9.8.1; UCRL-  
15673, 1.4.4.4.e  
**6.5.1.4** MIL-HDBK-759B; MIL-STD-  
1472D, 5.9.9.5.1.1; MIL-STD-  
1800A, 4.3.16; UCRL-15673,  
1.13.3.3.c  
**6.5.1.5** MIL-HDBK-759B, 5.6.10.1.4  
**6.5.1.6** MIL-HDBK-759B, 5.6.10.3.1;  
UCRL-15673, 1.10.3.4  
**6.5.1.7** AFSC DH 1-3, dn 2G3  
**6.5.1.8** AFSC DH 1-3, DN 2G3; MIL-  
STD-1472D, 5.9.6; UCRL-15673,  
1.4.4.4.b  
**6.5.1.9** MIL-HDBK-759B, 5.6.18.9; MIL-  
STD-1472D, 5.9.9.7; UCRL-  
15673, 1.10.4.3  
**6.5.2.1** UCRL-15673, 1.10.3.2  
**6.5.3.1** MIL-HDBK-759B, 5.6.10.1.2.a  
**6.5.3.2** UCRL-15673, 1.4.4.2.b, 1.10.4.3  
**6.5.4.1** AFSC DH 1-3, DN 2G3, 2.4;  
MIL-STD-1472D, 5.9.4.1; MIL-  
STD-1800A, 4.3.12  
**6.5.4.2** MIL-HDBK-759B, 5.6.10.1.4;  
MIL-STD-1472D, 5.9.9.2; UCRL-  
15673,  
**6.5.5.1** UCRL-15673, 1.10.4.2  
**6.5.5.2** MIL-HDBK-759B, 5.6.10.1.4;  
MIL-STD-1472D, 5.9.9.2; NASA-  
STD-3000A, 12.3.1.2.t; UCRL-  
15673, 1.4.3.8, 1.10.4.1

- 6.5.5.3** MIL-STD-1472D, 5.9.9.2  
**6.5.6.1** UCRL-15673, 1.4.10.2  
**6.5.6.2** UCRL-15673, 1.4.10.2  
**6.5.6.3** UCRL-15673, 1.4.10.2  
**6.5.6.4** UCRL-15673, 1.4.10.2  
**6.5.7.1** MIL-HDBK-759B, 5.6.8.2; MIL-STD-1472D, 5.9.9.5.1.6; UCRL-15673, 1.4.3.15  
**6.5.7.2** AFSC DH 1-3, DN 2G3; MIL-STD-1472D, 5.9.9.5.1.6; NASA-STD-3000A, 12.3.1.2.s; UCRL-15673, 1.4.3.16  
**6.5.8.1** MIL-STD-1472D, 5.9.9.2  
**6.5.8.2** MIL-STD-1472D, 5.9.9.7  
**6.5.8.3** UCRL-15673, 1.10.3.5  
**6.5.8.4** MIL-HDBK-759B, 5.6.25.4.b  
**6.5.8.5** AFSC DH 1-3, DN 2G3; MIL-HDBK-759B, 5.6.25.4.b  
**6.5.8.6** UCRL-15673, 1.10.3.5  
**6.5.8.7** MIL-HDBK-759B, 5.6.25.4.b; MIL-STD-1472D, 5.9.9.7  
**6.5.8.8** New  
**6.5.8.9** AFSC DH 1-3, DN 2G3; MIL-HDBK-759B, 5.6.11.1.4; MIL-STD-1800A, 4.3.12  
**6.5.8.10** UCRL-15673, 1.4.3.9  
**6.5.8.11** MIL-STD-1472D, 5.9.10.2  
**6.5.9.1** AFSC DH 1-3, DN 2G3; MIL-STD-1472D, 5.9.9.5.1.5; MIL-STD-1800A, 4.3.16; UCRL-15673, 1.4.4.4.c  
**6.5.9.2** AFSC DH 1-3, DN 2G3; UCRL-15673, 1.4.4.4.c  
**6.5.9.3** MIL-STD-1472D, 5.9.9.5.1.5  
**6.5.10.1** AFSC DH 1-3, DN 2G3; MIL-STD-1472D, 5.9.8.2; UCRL-15673, 1.4.3.11  
**6.5.10.2** MIL-STD-1472D, 5.9.9.3; 5.9.9.5.1.5  
**6.5.10.3** MIL-STD-1472D, 5.9.9.3  
**6.6.1.1** AFSC DH 1-3, DN 2G3; MIL-HDBK-759B, 5.6.10.2; MIL-STD-1472D, 5.9.7.2  
**6.6.1.2** AFSC DH 1-3, DN 2G3, 2.4  
**6.6.1.3** MIL-HDBK-759B, 5.6.10.1.4  
**6.6.1.4** MIL-HDBK-759B, 5.6.10.2; UCRL-15673, 1.10.4.5.d  
**6.6.1.5** MIL-HDBK-759B, 5.6.10.1.4, 5.6.10.2  
**6.6.1.6** MIL-HDBK-759B, 5.6.10.1.2.c  
**6.6.1.7** AFSC DH 1-3, DN 2G3  
**6.6.2.1** MIL-STD-1472D, 5.9.7.3  
**6.6.2.2** AFSC DH 1-3, DN 2G3; MIL-HDBK-759B, 5.6.10.1.2.d, 5.6.10.2; MIL-STD-1472D, 5.9.7.2, 5.9.7.3  
**6.6.3.1** MIL-HDBK-759B, 5.6.10.2  
**6.6.3.2** AFSC DH 1-3, DN 2G3; MIL-HDBK-759B, 5.6.10.2  
**6.6.3.3** MIL-HDBK-759B, 5.6.10.1.4  
**6.6.3.4** MIL-HDBK-759B, 5.6.10.1.4; MIL-STD-1472D, 5.9.7.2  
**6.6.3.5** AFSC DH 1-3, DN 2G3; MIL-STD-1472D, 5.9.8.1; UCRL-15673, 1.4.4.4.e  
**6.6.4.1** MIL-STD-1472D, 5.9.9.2  
**6.6.4.2** MIL-STD-1472D, 5.9.9.7  
**6.6.4.3** UCRL-15673, 1.10.3.5  
**6.6.4.4** MIL-HDBK-759B, 5.6.25.4.b  
**6.6.4.5** AFSC DH 1-3, DN 2G3; MIL-HDBK-759B, 5.6.25.4.b  
**6.6.4.6** UCRL-15673, 1.10.3.5  
**6.6.4.7** MIL-STD-1472D, 5.9.9.7  
**6.6.4.8** New  
**6.6.4.9** AFSC DH 1-3, DN 2G3; MIL-HDBK-759B, 5.6.11.1.4; MIL-STD-1800A, 4.3.12  
**6.6.5.1** AFSC DH 1-3, DN 2G3; MIL-STD-1472D, 5.9.9.5.1.5; MIL-STD-1800A, 4.3.16; UCRL-15673, 1.4.4.4.c  
**6.6.5.2** AFSC DH 1-3, DN 2G3; UCRL-15673, 1.4.4.4.c  
**6.6.5.3** MIL-STD-1472D, 5.9.9.5.1.5  
**6.6.6.1** AFSC DH 1-3, DN 2G3; MIL-STD-1472D, 5.9.8.2; UCRL-15673, 1.4.3.11  
**6.6.6.2** MIL-STD-1472D, 5.9.9.3, 5.9.9.5.1.5  
**6.6.6.3** MIL-STD-1472D, 5.9.9.3  
**6.7** MIL-HDBK-759B, 5.6.11.1; UCRL-15673, 1.11.3.2  
**6.7.1.1** MIL-STD-1472D, 5.9.9.2  
**6.7.1.2** MIL-STD-1472D, 5.9.9.7  
**6.7.1.3** MIL-HDBK-759B, 5.6.11.1.2; UCRL-15673, 1.10.3.5  
**6.7.1.4** UCRL-15673, 1.10.3.5  
**6.7.1.5** AFSC DH 1-3, DN 2G3; MIL-STD-1472D, 5.9.9.7, 5.9.10.1; MIL-STD-1800A, 4.3.17  
**6.7.1.6** New  
**6.7.1.7** AFSC DH 1-3, DN 2G3; MIL-HDBK-759B, 5.6.11.1.4; MIL-STD-1800A, 4.3.12  
**6.7.1.8** MIL-HDBK-759B, 5.6.11.1.2; MIL-STD-1472D, 5.9.10.1; UCRL-15673, 1.11.3.3  
**6.7.1.9** MIL-STD-1472D, 5.9.10.5.3  
**6.7.1.10**  
    **a.** AFSC DH 1-3, DN 2G3; MIL-HDBK-759B, 5.6.11.1.2  
    **b.** MIL-STD-1472D, 5.9.10.1  
**6.7.1.11**  
    **a.** AFSC DH 1-3, DN 2G3; MIL-STD-1472D, 5.9.10.6; UCRL-15673, 1.11.3.11  
    **b.** UCRL-15673, 1.11.3.11  
    **c.** UCRL-15673, 1.11.3.11  
    **d.** UCRL-15673, 1.11.3.11  
    **e.** AFSC DH 1-3, DN 2G3; MIL-HDBK-759B, 5.6.11.1.3; UCRL-15673, 1.4.4.1.h.1, 1.11.3.11  
**6.7.1.12** MIL-HDBK-759B, 5.6.11.1.3  
**6.7.1.13** NASA-STD-3000A, 12.3.2.1.h  
**6.7.1.14** AFSC DH 1-3, DN 2G3  
**6.7.1.15** MIL-STD-1472D, 5.9.10.5.1  
**6.7.2.1** AFSC DH 1-3, DN 2G3; MIL-STD-1472D, 5.9.10.4; MIL-STD-1800A, 4.3.17; UCRL-15673, 1.11.3.6, 1.11.3.8  
**6.7.2.2** UCRL-15673, 1.11.3.9  
**6.7.2.3** MIL-STD-1472D, 5.9.10.2; UCRL-15673, 1.11.3.7

- 6.7.2.4 AFSC DH 1-3, DN 2G3; MIL-STD-1472D, 5.9.10.2
- 6.7.3 MIL-HDBK-759B, 5.6.11.2
- 6.7.3.1.1 MIL-HDBK-759B, 5.6.11.2.5; UCRL-15673, 1.11.4.6.a
- 6.7.3.1.2 MIL-HDBK-759B, 5.6.11.2.5; UCRL-15673, 1.11.4.6.a
- 6.7.3.1.3 UCRL-15673, 1.11.4.6.a
- 6.7.3.1.4 UCRL-15673, 1.11.4.6.a
- 6.7.3.1.5 MIL-HDBK-759B, 5.6.11.2.5; UCRL-15673, 1.11.4.6
- 6.7.3.1.6 UCRL-15673, 1.11.4.6.a; MIL-HDBK-759B, 5.6.11.2.5
- 6.7.3.1.7 MIL-HDBK-759B, 5.6.19.2.r
- 6.7.3.1.8 MIL-HDBK-759B, 5.6.11.1.3
- 6.7.3.1.9 UCRL-15673, 1.11.3.10
- 6.7.3.2 MIL-HDBK-759B, 5.6.11.2.4; UCRL-15673, 1.11.4.5
- 6.7.3.2.1 UCRL-15673, 1.11.4.5
- 6.7.3.2.2 MIL-HDBK-759B, 5.6.11.2.4; UCRL-15673, 1.11.4.5
- 6.7.3.2.3 MIL-HDBK-759B, 5.6.11.2.4; UCRL-15673, 1.11.4.5
- 6.7.3.2.4 MIL-HDBK-759B, 5.6.11.2.4; UCRL-15673, 1.11.4.5
- 6.7.3.2.5 UCRL-15673, 1.11.4.5
- 6.7.3.2.6 UCRL-15673, 1.11.4.5
- 6.7.3.2.7 UCRL-15673, 1.11.4.5
- 6.7.3.2.8 UCRL-15673, 1.11.4.5
- 6.7.3.3 MIL-HDBK-759B, 5.6.11.2.6; UCRL-15673, 1.11.4.4
- 6.7.3.3.1 MIL-STD-1472D, 5.9.10.5.3
- 6.7.3.3.2 MIL-STD-1472D, 5.9.10.5.3; UCRL-15673, 1.11.4.4
- E6.7.3.3.2 UCRL-15673, 1.11.4.4; MIL-STD-1472D, 5.9.10.5.3
- 6.7.3.3.3 MIL-STD-1472D, 5.9.10.5.2
- 6.7.3.3.4 MIL-STD-1472D, 5.9.10.5.2
- E6.7.3.3.4 UCRL-15673, 1.11.4.7
- 6.7.3.3.6 MIL-STD-1472D, 5.9.10.5.1
- 6.7.3.3.7 MIL-STD-1472D, 5.9.10.5.2
- 6.7.3.4 UCRL-15673, 1.11.4.2
- 6.7.3.4.1 UCRL-15673, 4.3.26.1.4
- 6.7.3.4.2 UCRL-15673, 4.3.26.1.4
- 6.7.3.4.3 MIL-HDBK-759B, 5.6.11.2.2.b; UCRL-15673, 1.11.4.2
- 6.7.3.4.4 MIL-HDBK-759B, 5.6.11.2.2.d
- 6.7.3.4.5 MIL-HDBK-759B, 5.6.11.2.2.c
- 6.7.3.4.6 UCRL-15673, 1.11.4.2
- 6.7.3.5.1 MIL-HDBK-759B, 5.6.11.1.4; UCRL-15673, 1.11.3.5
- 6.7.3.5.2 UCRL-15673, 1.11.4.9.c
- 6.7.3.5.3 UCRL-15673, 1.11.4.9.e
- 6.7.3.5.4 MIL-STD-1472D, 5.9.10.2
- 6.7.3.5.5 UCRL-15673, 1.11.4.9.d
- 6.7.3.5.6 MIL-HDBK-759B, 5.6.11.1.4; UCRL-15673, 1.11.4.8
- 6.7.3.5.7 UCRL-15673, 1.11.4.9.f
- 6.7.3.5.8 UCRL-15673, 1.11.4.9.a
- 6.7.3.6 MIL-HDBK-759B, 5.6.11.2.1; UCRL-15673, 1.11.4.1
- 6.7.3.6.1 MIL-HDBK-759B, 5.6.11.2.1.a; MIL-STD-1472D, 5.9.10.7; UCRL-15673, 1.11.4.1
- 6.7.3.6.2 MIL-HDBK-759B, 5.6.11.2.1.b; UCRL-15673, 1.11.4.1
- 6.7.3.6.3 MIL-HDBK-759B, 5.6.11.2.1.c; UCRL-15673, 1.11.4.1
- 6.7.3.6.4 MIL-HDBK-759B, 5.6.11.2.1.d; UCRL-15673, 1.11.4.1
- 6.7.3.6.5 AFSC DH 1-3, DN 2G3; MIL-STD-1472D, 5.9.10.7
- 6.7.3.7 MIL-HDBK-759B, 5.6.11.2.3; UCRL-15673, 1.11.4.3
- 6.7.3.7.1 UCRL-15673, 1.11.4.3; MIL-HDBK-759B, 5.6.11.2.3.a; MIL-STD-1472D, 5.9.10.3
- 6.7.3.7.2 UCRL-15673, 1.11.4.3; MIL-HDBK-759B, 5.6.11.2.3.b
- 6.7.3.7.3 UCRL-15673, 1.11.4.3; MIL-HDBK-759B, 5.6.11.2.3.c
- 6.7.3.7.4 MIL-STD-1472D, 5.9.10.3
- 6.7.3.7.5 MIL-HDBK-759B, 5.6.18.9
- 6.7.3.7.6 AFSC DH 1-3, DN 2G3, 2.1.2.c
- 6.7.4.1 AFSC DH 1-3, DN 2G3
- 6.7.4.2 MIL-STD-1472D, 5.9.10.8
- 6.7.4.3 UCRL-15673, 1.11.3.12
- 6.7.4.4 UCRL-15673, 1.11.3.12
- 6.8.1.1 MIL-HDBK-759B, 5.6.9.1.2
- 6.8.1.2 MIL-HDBK-759B, 5.6.9.1.2
- 6.8.1.3 MIL-HDBK-759B, 5.6.9.1.2, 5.6.9.2.3, 5.6.19.2.o; UCRL-15673, 1.9.3.3.b
- 6.8.1.4 MIL-HDBK-759B, 5.6.9.1.1
- 6.8.1.5 MIL-HDBK-759B, 5.6.9.1.6.1
- 6.8.1.6 MIL-STD-1472D, 5.9.14.13; MIL-STD-1800A, 4.3.21.12
- 6.8.2.1.1 UCRL-15673, 1.7.3.5
- 6.8.2.1.2 MIL-HDBK-759B, 5.6.9.1.6.2.a, 5.6.19.2.n
- 6.8.2.2 MIL-HDBK-759B, 5.6.9.2.1; UCRL-15673, 1.9.3.3.a
- 6.8.2.2.1 MIL-HDBK-759B, 5.6.9.2.1
- 6.8.2.2.2 MIL-STD-1800A, 4.3.21.2
- 6.8.2.3.1 MIL-HDBK-759B, 5.6.9.2.3
- 6.8.2.4 MIL-HDBK-759B, 5.6.9.2.2; UCRL-15673, 1.9.3.3.b
- E6.8.2.4 UCRL-15673, 1.9.3.3.b;
- 6.8.2.4.1 AFSC DH 1-3, DN 2G3; MIL-HDBK-759B, 5.6.9.2.2; MIL-STD-1472D, 5.9.14.1; MIL-STD-1800A, 4.3.21.1; UCRL-15673, 1.9.3.3.b
- 6.8.2.4.2 UCRL-15673, 1.9.3.3.b
- 6.8.3.1 MIL-HDBK-759B, 5.6.9.1.4; NASA-STD-3000A, 12.3.1.2.j
- 6.8.3.2 MIL-HDBK-759B, 5.6.9.1.3
- 6.8.3.3 MIL-HDBK-759B, 5.6.9.1.3
- 6.8.3.4 MIL-STD-1472D, 5.9.14.9; MIL-STD-1800A, 4.3.21.8; NASA-STD-3000A, 12.3.1.2.1
- 6.8.3.5 MIL-HDBK-759B, 5.6.9.1.6
- 6.8.3.6 AFSC DH 1-3, DN 2G3; MIL-HDBK-759B, 5.6.9.1.5; MIL-STD-1472D, 5.9.14.8
- 6.8.3.7 MIL-STD-1472D, 5.9.14.8
- 6.8.4.1 MIL-STD-1472D, 5.9.14.3; MIL-STD-1800A, 4.3.21.4
- 6.8.4.2 MIL-STD-1472D, 5.9.14.5; MIL-STD-1800A, 4.3.21.5; UCRL-15673, 1.9.4.1.c
- 6.8.4.3 MIL-STD-1472D, 5.9.14.6; MIL-STD-1800A, 4.3.21.6



- 6.8.4.4** MIL-STD-1472D, 5.9.14.7; MIL-STD-1800A, 4.3.21.7; MIL-HDBK-759B, 5.6.9.1.8; AFSC DH 1-3, DN 2G3
- 6.8.4.5** MIL-STD-1472D, 5.9.14.10
- 6.8.5.1.1** UCRL-15673, 1.9.4.1.c
- 6.8.5.1.2** MIL-HDBK-759B, 5.6.9.1.6.2.d, 5.6.9.1.6.2.e, 5.6.9.3.1, 5.6.9.3.4.3, 5.6.9.3.4.4; UCRL-15673, 1.9.4.1.c
- 6.8.5.1.3** MIL-STD-1472D, 5.9.14.5; MIL-STD-1800A, 4.3.21.5; UCRL-15673, 1.8.4.1.c
- 6.8.5.1.4** AFSC DH 1-3, DN 2G3; MIL-HDBK-759B, 5.6.9.3.1; UCRL-15673, 1.9.4.1.c
- 6.8.5.1.5** MIL-HDBK-759B, 5.6.9.3.1
- 6.8.5.1.6** AFSC DH 1-3, DN 2G3; MIL-HDBK-759B, 5.6.9.3.1; UCRL-15673, 1.9.4.1.c
- 6.8.5.1.7** UCRL-15673, 1.9.4.1.c
- 6.8.5.1.8** AFSC DH 1-3, DN 2G3; MIL-HDBK-759B, 5.6.9.3.1; UCRL-15673, 1.9.4.1.c
- 6.8.5.1.9** MIL-HDBK-759B, 5.6.9.3.1
- 6.8.5.1.10** UCRL-15673, 1.9.4.1.c
- 6.8.5.1.11** AFSC DH 1-3, DN 2G3; UCRL-15673, 1.9.4.1.c
- 6.8.5.1.12** AFSC DH 1-3, DN 2G3; UCRL-15673, 1.9.4.1.c
- 6.8.5.1.13** AFSC DH 1-3, DN 2G3; UCRL-15673, 1.9.4.1.c
- 6.8.5.1.14** MIL-STD-1472D, 5.9.14.12; MIL-STD-1800A, 4.3.21.11
- 6.8.5.1.15** MIL-STD-1800A, 4.3.21.10
- 6.8.5.2.1** MIL-HDBK-759B, 5.6.16.3.3; UCRL-15673, 1.6.4.1.d;
- 6.8.5.2.2** MIL-HDBK-759B, 5.6.16.3.3.1
- 6.8.5.2.3** MIL-HDBK-759B, 5.6.9.1.6.2.c, 5.6.16.4.4
- E6.8.5.2.3** MIL-HDBK-759B, 5.6.16.4.4; UCRL-15673, 1.6.4.1.g.3
- 6.8.5.2.4** UCRL-15673, 1.9.3.3.c
- E6.8.5.2.4** UCRL-15673, 1.9.3.3.c
- 6.8.5.2.5** UCRL-15673, 1.9.3.3.c
- 6.8.5.2.6** UCRL-15673, 1.9.3.3.c
- 6.8.5.2.7** UCRL-15673, 1.6.4.1.b.3, 1.9.3.3.c; AFSC DH 1-3, DN 2G3
- E6.8.5.2.7** AFSC DH 1-3, DN 2G3, 2.1.3.c
- 6.8.5.2.8** UCRL-15673, 1.9.3.3.c
- 6.8.5.2.9** UCRL-15673, 1.6.4.1.b.4; AFSC DH 1-3, DN 2G3
- 6.8.5.2.10** UCRL-15673, 1.6.4.1.b.5; AFSC DH 1-3, DN 2G3
- 6.8.5.2.11** UCRL-15673, 1.6.4.1.b.2
- 6.8.5.2.12** UCRL-15673, 1.9.3.3
- 6.8.6.1** UCRL-15673, 1.9.4.2.a
- 6.8.6.2** UCRL-15673, 1.9.4.2.a; MIL-HDBK-759B, 5.6.9.3.6
- 6.8.6.3** MIL-HDBK-759B, 5.6.9.3.6; UCRL-15673, 1.9.4.2.a
- 6.8.6.4** MIL-HDBK-759B, 5.6.9.1.4; NASA-STD-3000A, 12.3.2.1.f
- 6.8.6.5** MIL-HDBK-759B, 5.6.9.3.6
- 6.8.7.1** UCRL-15673, 1.9.4.2.b
- 6.8.7.2** MIL-HDBK-759B, 5.6.9.3.6.1; UCRL-15673, 1.9.4.2.b
- 6.8.7.3** UCRL-15673, 1.9.4.2.b
- 6.8.7.4** UCRL-15673, 1.9.4.2.b; MIL-HDBK-759B, 5.6.9.3.6.1
- 6.8.7.5** UCRL-15673, 1.9.4.2.b
- 6.8.7.6** UCRL-15673, 1.9.4.2.b
- 6.8.7.7** UCRL-15673, 1.9.4.2.b; MIL-HDBK-759B, 5.6.9.3.6.1, 5.6.26.5
- 6.8.7.8** UCRL-15673, 1.9.4.2.b
- 6.8.8.1** MIL-HDBK-759B, 5.6.9.1.6.2.f, 5.6.9.1.8, 5.6.9.3.4, 5.6.9.3.4.2
- 6.8.8.2** MIL-HDBK-759B, 5.6.9.1.8, 5.6.9.3.4.2
- 6.8.8.3** MIL-HDBK-759B, 5.6.9.1.8
- 6.8.8.4** AFSC DH 1-3, DN 2G3; UCRL-15673, 1.3.4.2.c
- 6.8.8.6** MIL-HDBK-759B, 5.6.9.1.8.2
- 6.8.8.7** MIL-HDBK-759B, 5.6.9.1.8.2
- 6.8.8.8** MIL-HDBK-759B, 5.6.1.8.1
- 6.8.8.9** MIL-HDBK-759B, 5.6.9.1.7
- 6.8.8.10** MIL-STD-454M, Requirement 67, 4.7
- 6.8.8.11** MIL-HDBK-759B, 5.6.9.1.8; AFSC DH 1-3, DN 2G3; MIL-STD-1472D, 5.9.14.7; MIL-STD-1800A, 4.3.21.7
- 6.9** UCRL-15673, 1.6.2;
- 6.9.1.1.1** MIL-HDBK-759B, 5.6.16.1; UCRL-15673, 1.6.3.1
- 6.9.1.1.2** UCRL-15673, 1.6.4.1.i
- 6.9.1.1.3** UCRL-15673, 1.6.3.2
- 6.9.1.1.4** MIL-HDBK-759B, 5.6.24.6.2.k
- 6.9.1.1.5** MIL-HDBK-759B, 5.6.16.3.3.1
- 6.9.1.1.6** UCRL-15673, 1.6.4.1.f
- 6.9.1.1.7** UCRL-15673, 1.6.4.1.c; AFSC DH 1-3, DN 2G3
- 6.9.1.1.8** MIL-HDBK-759B, 5.6.16.4.7.d
- 6.9.1.1.9** MIL-HDBK-759B, 5.6.24.6.2.g
- 6.9.1.1.10** MIL-STD-1800A, 4.3.20.6
- 6.9.1.1.11** UCRL-15673, 1.6.4.1.j
- 6.9.1.1.12** MIL-HDBK-759B, 5.6.24.6.2.f, 5.6.16.4.7.e
- 6.9.1.1.13** MIL-HDBK-759B, 5.6.16.4.7.h
- E6.9.1.1.13** MIL-HDBK-759B, 5.6.16.4.7.h
- 6.9.1.1.14** MIL-STD-1472D, 5.9.13.7; MIL-HDBK-759B, 5.6.24.6.2.e
- 6.9.1.2.1** MIL-HDBK-759B, 5.6.16.4.3; AFSC DH 1-3, DN 2G3
- 6.9.1.2.2** AFSC DH 1-3, DN 2G3; MIL-STD-1472D, 5.9.13.3; MIL-STD-1800A, 4.3.20.3
- 6.9.1.2.3** AFSC DH 1-3, DN 2G3; MIL-STD-1800A, 4.3.20.3
- 6.9.1.2.4** AFSC DH 1-3, DN 2G3; NASA-STD-3000A, 12.3.1.2.m.3
- 6.9.1.2.5** UCRL-15673, 1.6.4.1.d; MIL-HDBK-759B, 5.6.16.3.3
- 6.9.1.2.6** MIL-HDBK-759B, 5.6.16.4.7; UCRL-15673, 1.6.4.1.h
- E6.9.1.2.6** MIL-HDBK-759B, 5.6.16.4.7.g
- 6.9.1.3.1** AFSC DH 1-3, DN 2G3, 3.1
- 6.9.1.3.2** UCRL-15673, 1.6.4.1.f
- 6.9.1.3.3** UCRL-15673, 1.6.4.1.f
- 6.9.1.3.4** MIL-HDBK-759B, 5.6.16.3.1
- 6.9.1.3.5** UCRL-15673, 1.6.4.1.f
- 6.9.1.3.6** UCRL-15673, 1.6.4.1.f

- 6.9.1.3.7** NASA-STD-3000A, 12.3.1.2.m.1; MIL-STD-1800A, 4.3.20.5; MIL-STD-1472D, 5.9.13.5; MIL-HDBK-759B, 5.6.16.4.2; UCRL-15673, 1.6.3.7
- 6.9.1.3.8** MIL-HDBK-759B, 5.6.16.1.2.a
- 6.9.1.3.9** MIL-HDBK-759B, 5.6.16.1.2.c
- 6.9.1.3.10** UCRL-15673, 1.6.3.5; MIL-HDBK-759B, 5.6.16.4.7.c
- 6.9.1.3.11** MIL-HDBK-759B, 5.6.16.4.2
- 6.9.1.3.12** MIL-STD-1472D, 5.9.13.4
- 6.9.1.3.13** UCRL-15673, 1.6.3.6
- 6.9.1.3.14** NASA-STD-3000A, 12.3.1.2.m.4; UCRL-15673, 1.6.3.8
- 6.9.1.3.15** UCRL-15673, 1.6.3.4
- 6.9.1.4.1** UCRL-15673, 1.6.4.1.g
- 6.9.1.4.2** UCRL-15673, 1.6.4.1.g
- 6.9.1.4.3** UCRL-15673, 1.6.4.1.g
- 6.9.1.4.4** UCRL-15673, 1.6.4.1.g
- 6.9.1.4.5** UCRL-15673, 1.6.4.1.g
- 6.9.1.5.1** UCRL-15673, 1.6.3.9.a
- 6.9.1.5.2** MIL-HDBK-759B, 5.6.16.1.3; UCRL-15673, 1.6.3.9
- 6.9.1.5.3** MIL-HDBK-759B, 5.6.16.1.3
- E6.9.1.5.3** UCRL-15673, 1.6.3.9
- 6.9.1.5.4** UCRL-15673, 1.6.3.9
- 6.9.1.5.5** MIL-STD-1800A, 4.3.20.2; MIL-HDBK-759B, 5.6.24.6.2.h
- 6.9.1.5.6** MIL-STD-1800A, 4.3.20.2
- 6.9.1.5.7** MIL-STD-1472D, 5.9.13.2
- 6.9.1.5.8** UCRL-15673, 1.6.3.9
- 6.9.1.6.1** UCRL-15673, 1.6.4.1.e
- 6.9.1.6.2** UCRL-15673, 1.6.4.1.e
- 6.9.1.6.3** UCRL-15673, 1.6.4.1.e
- 6.9.1.6.4** NASA-STD-3000A, 12.3.2.2.g; MIL-STD-1800A, 4.3.20.4
- 6.9.1.6.5** UCRL-15673, 1.6.3.10
- 6.9.1.6.6** UCRL-15673, 1.6.3.10
- E6.9.1.6.6** UCRL-15673, 1.6.3.10
- 6.9.1.6.7** UCRL-15673, 1.6.3.10
- 6.9.1.6.8** UCRL-15673, 1.6.3.10
- E6.9.1.6.8** UCRL-15673, 1.6.3.10
- 6.9.1.7.1** AFSC DH 1-3, DN 2G5, 3.2.a
- 6.9.1.7.2** AFSC DH 1-3, DN 2G5, 3.2.b
- 6.9.1.7.3** AFSC DH 1-3, DN 2G5, 3.2.c
- 6.9.1.7.4** AFSC DH 1-3, DN 2G5, 3.2.d
- 6.9.1.8.1** UCRL-15673, 1.3.3.12, 1.3.3.10, 1.6.4.1.k; MIL-HDBK-759B, 5.6.24.6.2.j
- 6.9.1.8.2** MIL-STD-1472D, 5.9.13.8; MIL-STD-1800A, 4.3.20.7
- 6.9.1.8.3** AFSC DH 1-3, DN 2G3; UCRL-15673, 1.3.4.2.c
- 6.9.1.8.4** MIL-HDBK-759B, 5.6.16.3.2, 5.6.9.3.5
- 6.9.1.8.5** MIL-STD-1472D, 5.9.13.1; MIL-STD-1800A, 4.3.20.1
- 6.9.1.8.6** MIL-STD-1472D, 5.9.12.5
- 6.9.1.8.7** New
- 6.9.2.1.1** MIL-HDBK-759B, 5.6.16.2.2; UCRL-15673, 1.6.4.2.b.2
- 6.9.2.1.2** UCRL-15673, 1.6.4.2.b.3
- 6.9.2.1.3** MIL-HDBK-759B, 5.6.26.5, 5.6.9.3.6.1
- E6.9.2.1.3** MIL-HDBK-759B, 5.6.26.5
- 6.9.2.1.4** UCRL-15673, 1.9.4.2.c
- 6.9.2.1.5** MIL-HDBK-759B, 5.6.26.6.j; UCRL-15673, 1.6.4.3.6.5
- 6.9.2.1.6** MIL-HDBK-759B, 5.6.26.6.j; UCRL-15673, 1.6.4.3.6.5
- 6.9.2.1.7** MIL-HDBK-759B, 5.6.16.2.3; UCRL-15673, 1.6.4.2.a
- 6.9.2.1.8** MIL-HDBK-759B, 5.6.16.2.1; UCRL-15673, 1.6.4.2.a
- 6.9.2.1.9** NASA-STD-3000A, 12.3.1.4.e
- 6.9.2.1.10** MIL-HDBK-759B, 5.6.16.2.1; UCRL-15673, 1.6.4.2.a
- 6.9.2.1.11** MIL-HDBK-759B, 5.6.16.2.4
- 6.9.2.2.1** NASA-STD-3000A, 12.3.1.2.m.2
- 6.9.2.2.2** MIL-HDBK-759B, 5.6.16.2.2
- 6.9.2.2.3** MIL-HDBK-759B, 5.6.16.4.7.c; UCRL-15673, 1.6.3.5
- 6.9.2.2.4** MIL-HDBK-759B, 5.6.16.2.2
- 6.9.2.2.5** UCRL-15673, 1.6.3.9; MIL-HDBK-759B, 5.6.16.1.3
- 6.9.2.2.6** UCRL-15673, 1.6.4.2.b.5
- 6.9.2.3.1** UCRL-15673, 1.6.4.2.b.4; MIL-HDBK-759B, 5.6.16.2.5
- 6.9.2.3.2** MIL-HDBK-759B, 5.6.16.1.3
- 6.9.2.4.1** MIL-HDBK-759B, 5.6.9.3.6.2; UCRL-15673, 1.5.4.c
- 6.9.2.4.2** UCRL-15673, 1.5.4.1.c
- 6.9.2.4.3** MIL-HDBK-759B, 5.6.16.2.3; UCRL-15673, 1.6.4.2.a
- 6.9.2.4.4** MIL-HDBK-759B, 5.6.18.6.1.e
- 6.9.2.4.5** UCRL-15673, 1.5.4.1.b
- E6.9.2.4.5** UCRL-15673, 1.5.4.1.b
- 6.10.1.1** MIL-HDBK-759B, 5.6.18.7
- 6.10.1.2** MIL-HDBK-759B, 5.6.18.7
- 6.10.1.3** UCRL-15673, 1.2.2
- 6.10.1.4** UCRL-15673, 1.2.2
- 6.10.2.1.1** AFSC DH 1-3, dn 2G3; MIL-STD-1800A, 4.3.2; UCRL-15673, 1.1.3.1.a
- 6.10.2.1.2** UCRL-15673, 1.1.3.1.d
- 6.10.2.1.3** MIL-HDBK-759B, 5.6.19.2.a; MIL-STD-1472D, 5.9.2.2; NASA-STD-3000A, 12.3.1.4.1
- 6.10.2.1.4** NASA-STD-3000A, 12.3.1.4.1
- 6.10.2.1.5** UCRL-15673, 1.1.3.1.n
- 6.10.2.1.6** MIL-HDBK-759B, 5.6.18.7.d
- 6.10.2.1.7** UCRL-15673, 1.1.3.1.e
- 6.10.2.2.1** UCRL-15673, 1.2.4.1.
- 6.10.2.2.2** UCRL-15673, 1.2.4.1.a
- 6.10.2.2.3** UCRL-15673, 1.2.4.1.b
- 6.10.2.2.4** UCRL-15673, 1.2.4.1.c
- 6.10.2.2.5** MIL-STD-1472D, 5.9.18
- 6.10.3.1.1** AFSC DH 1-3, DN 2G3; MIL-HDBK-759B, 5.6.20.1
- 6.10.3.1.2** AFSC DH 1-3, DN 2G3; MIL-STD-1472D, 5.9.2.1
- 6.10.3.1.3** AFSC DH 1-3, DN 2G3; MIL-HDBK-759B, 5.6.20.1.5
- 6.10.3.1.4** AFSC DH 1-3, DN 2G3; MIL-HDBK-759B, 5.6.18.7.a
- 6.10.3.1.5** AFSC DH 1-3, DN 2G3; UCRL-15673, 1.7.4.1.c.5
- 6.10.3.1.6** AFSC DH 1-3, DN 2G3
- 6.10.3.1.7** AFSC DH 1-3, DN 2G3, 2.4.d
- 6.10.3.1.8** AFSC DH 1-3, DN 2G3; MIL-STD-1472D, 5.9.4.6
- 6.10.3.1.9** UCRL-15673, 1.5.3.2.b
- 6.10.3.1.10** MIL-STD-1800A, 4.3.9.6

- 6.10.3.1.11** UCRL-15673, 1.2.3.1.g  
**6.10.3.2.1** UCRL-15673, 1.5.3.2.d  
**6.10.3.2.2** UCRL-15673, 1.5.3.2.e  
**6.10.3.3.1** AFSC DH 1-3, DN 2G3  
**6.10.3.3.2** AFSC DH 1-3, DN 2G3; MIL-STD-1472D, 5.9.2.3; UCRL-15673, 1.2.3.1.b  
**6.10.3.3.3** UCRL-15673, 1.2.3.1.c  
**6.10.3.3.4** AFSC DH 1-3, DN 2G3; MIL-HDBK-759B, 5.6.20.1.1.2; UCRL-15673, 1.2.3.1.d  
**6.10.3.3.5** MIL-HDBK-759B, 5.6.20.1.1.3  
**6.10.3.3.6** AFSC DH 1-3, DN 2G3; MIL-HDBK-759B, 5.6.20.1.1.3; UCRL-15673, 1.2.3.1.f  
**6.10.3.3.7** MIL-HDBK-759B, 5.6.20.1.1.3; UCRL-15673, 1.2.3.1.e  
**6.10.4** UCRL-15673, 1.2.4.2  
**6.10.4.1** MIL-HDBK-759B, 5.6.18.11; UCRL-15673, 1.2.4.2  
**E6.10.4.1** AFSC DH 1-3, DN 2G3, 2.3.j; MIL-HDBK-759B, 5.6.18.11; UCRL-15673, 1.2.4.2.a  
**6.10.4.2** MIL-HDBK-759B, 5.6.18.11; UCRL-15673, 1.2.4.2  
**6.10.4.3** MIL-HDBK-759B, 5.6.18.12; UCRL-15673, 1.2.4.2  
**6.10.4.4** MIL-HDBK-759B, 5.6.18.12; UCRL-15673, 1.2.4.2  
**6.10.4.5** UCRL-15673, 1.2.4.2  
**6.10.4.6** UCRL-15673, 1.2.4.2  
**6.10.4.7** MIL-HDBK-759B, 5.6.18.14.b, 5.6.19.2.a; MIL-STD-1472D, 5.9.1.8; NASA-STD-3000A, 1.2.3.1.4.k; UCRL-15673, 1.2.3.3.c, 1.2.3.3.d  
**E6.10.4.7** UCRL-15673, 1.2.3.3.d.4  
**6.10.4.8** MIL-STD-1472D, 5.9.2.2; MIL-STD-1800A, 4.3.7  
**6.10.4.9** AFSC DH 1-3, DN 2G3; MIL-HDBK-759B, 5.6.18.7.d; MIL-STD-1800A, 4.3.22.2  
**6.10.4.10** AFSC DH 1-3, Dn 2G3  
**6.10.4.11** AFSC DH 1-3, DN 2G3;  
**6.10.4.12** AFSC DH 1-3, DN 2G3, 2.3.e; NASA-STD-3000A, 12.3.1.4.b  
**6.10.4.13** MIL-STD-1472D, 5.9.7.1  
**6.10.4.14** AFSC DH 1-3, DN 2G3; MIL-STD-1472D, 5.8.14.11; NASA-STD-3000A, 12.3.1.1.m  
**6.10.5.1** UCRL-15673, 1.2.3.2.a; MIL-HDBK-759B, 5.6.18.6.1  
**6.10.5.2** UCRL-15673, 1.2.3.2.c, 1.3.4.3.e.6  
**6.10.5.3** UCRL-15673, 1.3.4.3.e.6  
**6.10.5.4** UCRL-15673, 1.3.4.2.c  
**6.10.5.5** UCRL-15673, 1.3.4.2.c  
**6.10.5.6** UCRL-15673, 1.3.4.2.c  
**6.10.5.7** UCRL-15673, 1.3.4.2.d  
**6.10.5.8** UCRL-15673, 1.3.4.2.c  
**6.10.5.9** UCRL-15673, 1.3.4.2.c  
**6.10.5.10** UCRL-15673, 1.3.4.2.c  
**6.10.5.11** UCRL-15673, 1.3.4.2.d  
**6.10.5.12** UCRL-15673, 1.3.4.2.d  
**6.10.5.13** UCRL-15673, 1.3.4.2.d  
**6.10.5.14** UCRL-15673, 1.3.4.2.d  
**6.10.5.15** UCRL-15673, 1.3.4.2.a  
**6.10.5.16** UCRL-15673, 1.3.4.2.b  
**6.10.5.17** MIL-HDBK-759B, 5.6.19.2.g  
**6.10.5.18** UCRL-15673, 1.4.3.12; AFSC DH 1-3, DN 2G3; MIL-HDBK-759B, 5.6.20.1.5  
**6.10.5.19** UCRL-15673, 1.2.3.2.a; MIL-HDBK-759B, 5.6.18.6.1.d  
**6.11.1** MIL-STD-1800A, 4.3.9.3  
**6.11.2** UCRL-15673, 1.3.4.2  
**6.11.3** MIL-HDBK-759B, 5.6.22.1.3.a  
**6.11.4** UCRL-15673, 1.5.3.1.d; NASA-STD-3000A, 9.2.3.2.6  
**6.11.5** MIL-HDBK-759B, 5.6.22.1.3.c  
**6.11.6** MIL-HDBK-759B, 5.6.22.1.3.d  
**6.11.7** UCRL-15673, 1.5.3.1.f  
**6.11.8** MIL-HDBK-759B, 5.6.22.1.3.e  
**6.11.9** MIL-HDBK-759B, 5.6.22.1.3.f; MIL-STD-1472D, 5.9.3.1; MIL-STD-1800A, 4.3.9.1  
**6.11.10** MIL-STD-1800A, 4.3.9.2  
**6.11.11** MIL-STD-1472D, 5.9.3.2; UCRL-15673, 1.4.4.4.f  
**6.11.12** MIL-STD-1472D, 5.9.3.3  
**6.11.13** UCRL-15673, 1.5.3.1.b  
**6.11.14** MIL-STD-1800A, 4.3.9.1  
**6.11.15** MIL-STD-1472D, 5.9.3.4; MIL-STD-1800A, 4.3.9.4  
**6.11.16** New  
**6.11.17** MIL-HDBK-759B, 5.6.18.14.a  
**6.11.18** MIL-STD-1472D, 5.9.3.5  
**6.11.19** MIL-STD-1472D, 5.9.3.5  
**6.11.20** MIL-STD-1472D, 5.9.3.6; MIL-STD-1800A, 4.3.9.5  
**6.12.1.1** NASA-STD-3000A, 12.3.2.1.h; MIL-STD-1472D, 5.9.17.1.3; MIL-STD-1800A, 4.3.24.1.3  
**6.12.1.2** MIL-STD-1472D, 5.9.17.1.3  
**6.12.1.3** UCRL-15673, 1.5.3.2.f  
**6.12.1.4** NASA-STD-3000A, 12.3.1.1.k  
**6.12.2.1** AFSC DH 1-3, DN 2G3  
**6.12.2.2** NASA-STD-3000A, 12.3.2.1.k; MIL-STD-1472D, 5.9.17.1.2; MIL-STD-1800A, 4.3.24.1.2  
**6.12.2.3** MIL-STD-1472D, 5.9.17.1.1; NASA-STD-3000A, 12.3.2.1.i; MIL-STD-1472D, 5.9.17.2.1; MIL-STD-1800A, 4.3.24.2.1; NASA-STD-3000A, 12.3.2.1.j  
**6.12.2.4** MIL-STD-1800A, 4.3.24.1.1  
**6.12.2.5** MIL-STD-1800A, 4.3.24.1.1  
**6.12.3.1** NASA-STD-3000A, 12.3.1.1.p  
**6.12.3.2** MIL-STD-1472D, 5.9.17.1.1  
**6.12.3.3** NASA-STD-3000A, 12.3.2.1.b  
**6.12.3.4** NASA-STD-3000A, 12.3.2.1.a; MIL-STD-1472D, 5.9.1.5  
**6.12.3.5** MIL-STD-1800A, 4.3.24.2.3; MIL-STD-1472D, 5.9.17.2.3  
**6.12.3.6** NASA-STD-3000A, 12.3.2.1.e  
**6.12.3.7** NASA-STD-3000A, 12.3.2.1.d  
**6.12.3.8** NASA-STD-3000A, 12.3.2.1.c; MIL-STD-1800A, 4.3.4  
**6.12.3.9** NASA-STD-3000A, 12.3.2.1.g  
**6.13.1.1** MIL-HDBK-759B, 5.6.24.2.j  
**6.13.1.2** NASA-STD-3000A, 12.3.1.2.n; MIL-STD-1472D, 5.9.17.2.2; MIL-HDBK-759B, 5.6.24.2.c

- 6.13.1.3** MIL-STD-1472D, 5.9.17.2.1; MIL-STD-1800A, 4.3.24.2.1; NASA-STD-3000A, 12.3.2.1.j  
**6.13.1.4** MIL-HDBK-759B, 5.6.24.2.a  
**6.13.2.1** MIL-HDBK-759B, 5.6.24.2.b  
**6.13.2.2** MIL-HDBK-759B, 5.6.24.2.i  
**6.13.2.3** MIL-HDBK-759B, 5.6.24.2.e  
**6.13.2.4** MIL-HDBK-759B, 5.6.24.2.g  
**6.13.2.5** MIL-STD-1800A, 4.3.24.2.2; MIL-STD-1472D, 5.9.17.2.2; AFSC DH 1-3, DN 2G3  
**6.13.2.6** MIL-HDBK-759B, 5.6.20.1.6; MIL-STD-1800A, 4.3.24.2.2; AFSC DH 1-3, DN 2G3; MIL-STD-1472D, 5.9.17.2.2  
**6.13.2.7** MIL-HDBK-759B, 5.6.24.2.f; MIL-STD-1472D, 5.9.17.2.3; MIL-STD-1800A, 4.3.24.3  
**6.13.2.8** MIL-HDBK-759B, 5.6.24.2.h  
**6.13.3.1** MIL-STD-1472D, 5.9.17.2.5  
**E6.13.3.1** Proposed MIL-STD-1472D, 5.4.3.1.8.2; MIL-STD-1472D, 5.9.17.2.5; MIL-HDBK-759B, 5.2.1.14.2; MIL-STD-1800A, 4.4.2.o  
**6.13.3.2** MIL-STD-1472D, 5.9.17.2.4; MIL-STD-1800A, 4.3.24.2.4  
**6.13.4** MIL-STD-1472D, 5.9.17.2.4  
**6.13.4.1** MIL-STD-1472D, 5.4.3.1.4.3; MIL-STD-1800A, 4.3.24.5  
**E6.13.4.1** Proposed MIL-STD-1472D, 5.4.3.1.4.3; MIL-STD-1472D, 5.4.3.1.4.3; MIL-STD-1800A, 4.3.24.2.5; MIL-STD-1800A, 4.4.2.1  
**6.13.4.2** MIL-STD-1472D, 5.4.3.1.5.1; MIL-STD-1800A, 4.3.24.5  
**E6.13.4.2** Proposed MIL-STD-1472D, 5.4.3.1.5.1; MIL-STD-1472D, 5.4.3.1.5.1; MIL-STD-1800A, 4.3.25.2.5  
**6.13.5.1** MIL-STD-1472D, 5.9.17.2.3; MIL-STD-1800A, 4.3.24.2.3  
**6.13.5.2** MIL-HDBK-759B, 5.6.24.2.k; MIL-STD-1472D, 5.9.17.2.3  
**6.13.5.3** MIL-STD-1800A, 4.3.24.2.3; MIL-STD-1472D, 5.9.17.2.3  
**6.14** UCRL-15673, 1.7.2  
**6.14.1.1** AFSC DH 1-3, DN 2G3; MIL-HDBK-759B, 5.6.22.1.2.g  
**6.14.1.2** AFSC DH 1-3, DN 2G3, 5.4.d  
**6.14.2.1** AFSC DH 1-3, DN 2G3, 5.1, 5.2.5  
**6.14.2.2** UCRL-15673, 1.7.4.1.b.7; AFSC DH 1-3, DN 2G3, 5.2  
**6.14.2.3** AFSC DH 1-3, DN 2G3  
**E6.14.2.3** UCRL-15673, 1.7.4.1.b.6  
**6.14.2.4** MIL-HDBK-759B, 5.6.22.1.2.e  
**6.14.2.5** NASA-STD-3000A, 12.3.2.2; MIL-STD-1472D, 5.9.15.1; UCRL-15673, 1.7.4.1.6  
**6.14.2.6** MIL-HDBK-759B, 5.6.22.1.2.a  
**6.14.2.7** UCRL-15673, 1.7.3.1  
**6.14.2.8** UCRL-15673, 1.7.3.2  
**6.14.2.9** MIL-HDBK-759B, 5.6.22.1.2.j  
**6.14.2.10** UCRL-15673, 1.7.3.3  
**6.14.2.11** MIL-HDBK-759B, 5.6.22.1.6.c  
**6.14.2.12** MIL-HDBK-759B, 5.6.22.1.6.d  
**6.14.2.13** UCRL-15673, 1.7.4.1.b.6  
**6.14.3.1** UCRL-15673, 1.7.4.2.c  
**6.14.3.2** UCRL-15673, 1.7.4.2.c  
**6.14.3.3** UCRL-15673, 1.7.4.2.c  
**6.14.3.4** UCRL-15673, 1.7.4.2.c  
**6.14.3.5** UCRL-15673, 1.7.4.2.c  
**6.14.3.6** UCRL-15673, 1.7.4.2.c  
**6.14.3.7** UCRL-15673, 1.7.4.2.c  
**6.14.3.8** UCRL-15673, 1.7.4.2.c  
**6.14.4.1** UCRL-15673, 1.7.4.1.b; AFSC DH 1-3, DN 2G3, 5.1  
**6.14.4.2** UCRL-15673, 1.7.4.1.b  
**6.14.4.3** UCRL-15673, 1.7.4.1.b; AFSC DH 1-3, DN 2G3, 5.1  
**6.14.4.4** AFSC DH 1-3, DN 2G3  
**E6.14.4.4**  
    **a.** AFSC DH 1-3, DN 2G3, 3.4.a; UCRL-15673, 1.9.4.c.9  
    **b.** AFSC DH 1-3, DN 2G3, 3.4.a; UCRL-15673, 1.9.4.c.9  
**6.14.5.1** AFSC DH 1-3, DN 2G3, 5.4.a  
**6.14.5.2** UCRL-15673, 1.7.3.6.d  
**6.14.5.3** UCRL-15673, 1.7.3.6.a  
**6.14.5.4** UCRL-15673, 1.7.4.1.a.2  
**6.14.5.5** UCRL-15673, 1.7.4.1.a.3  
**6.14.5.6** UCRL-15673, 1.7.4.2.a.3  
**6.14.6.1** UCRL-15673, 1.8.4.1.b  
**6.14.6.2** UCRL-15673, 1.7.3.12; AFSC DH 1-3, DN 2G3, 5.3.d  
**6.14.6.3** UCRL-15673, 1.7.3.12  
**6.14.6.4** NASA-STD-3000A, 12.3.2.2.e; UCRL-15673, 1.7.3.15  
**6.14.6.5** NASA-STD-3000A, 12.3.2.2.d; AFSC DH 1-3, DN 2G3, 5.3.a  
**6.14.6.6** AFSC DH 1-3, DN 2G3, 5.3.e  
**6.14.6.7** AFSC DH 1-3, DN 2G3, 5.3.b  
**6.14.6.8** UCRL-15673, 1.7.3.14  
**6.15** AFSC DH 1-3, Dn 2G5, 2.4; UCRL-15673, 1.8.2  
**6.15.1** UCRL-15673, 1.8.3.1.c, 1.8.3.1.b, 1.8.2  
**6.15.1.1.1** UCRL-15673, 1.8.2  
**6.15.1.1.2** NASA-STD-3000A, 12.3.2.1.n  
**6.15.1.1.3** UCRL-15673, 1.8.4.2.f  
**6.15.1.1.4** AFSC DH 1-3, DN 2G5, 2.6.e; UCRL-15673, 1.8.4.1.a  
**6.15.1.1.5** AFSC DH 1-3, DN 2G5, 2.6.c  
**6.15.1.1.6** AFSC DH 1-3, DN 2G5, 2.6.j  
**6.15.1.1.7** AFSC DH 1-3, DN 2G5, 2.6.h & i  
**6.15.1.1.8** AFSC DH 1-3, DN 2G5, 2.6.k  
**6.15.1.2.1** UCRL-15673, 1.8.4.3.a  
**6.15.1.2.2** MIL-HDBK-759B, 5.6.24.2.e  
**6.15.1.2.3** UCRL-15673, 1.8.4.3.b  
**6.15.1.2.4** UCRL-15673, 1.8.3.2.d  
**6.15.1.2.5** UCRL-15673, 1.8.3.2.f  
**6.15.1.2.6** UCRL-15673, 1.8.4.3.c  
**6.15.1.2.7** UCRL-15673, 1.8.4.3.d  
**6.15.1.2.8** UCRL-15673, 1.8.4.3.e  
**6.15.1.3.1** MIL-STD-1800A, 4.3.10.5  
**6.15.1.3.2** UCRL-15673, 1.7.3.4  
**6.15.1.3.3** AFSC DH 1-3, DN 2G5, 2.6.a; UCRL-15673, 1.8.4.2.a  
**6.15.1.3.4** AFSC DH 1-3, DN 2G5, 2.6.b  
**6.15.1.3.5** UCRL-15673, 1.8.4.2.b

- 6.15.1.4.1 AFSC DH 1-3, DN 2G5, 2.6.g;  
UCRL-15673, 1.8.4.2.c
- 6.15.1.4.2 UCRL-15673, 1.8.4.2.d; AFSC  
DH 1-3, DN 2G5, 2.6.f
- 6.15.1.4.3 UCRL-15673, 1.8.4.2.i
- 6.15.1.4.4 UCRL-15673, 1.8.4.2.h
- 6.15.2.1.1 AFSC DH 1-3, DN 2G3, 5.2.1
- 6.15.2.1.2 UCRL-15673, 1.7.4.1.c.2
- 6.15.2.1.3 UCRL-15673, 1.7.4.1.c.2
- 6.15.2.1.4 UCRL-15673, 1.7.4.1.c.2
- 6.15.2.2.1 AFSC DH 1-3, DN 2G3, 5.2.1
- 6.15.2.2.2 AFSC DH 1-3, DN 2G3, 5.2.1;  
UCRL-15673, 1.7.4.1.c.2
- 6.15.2.3.1 AFSC DH 1-3, DN 2G3, 5.2.3
- 6.15.2.3.2 NASA-STD-3000A, 12.3.2.1.g;  
AFSC DH 1-3, DN 2G3, 5.2.3;  
UCRL-15673, 1.7.4.1.c.3
- 6.15.2.3.3 MIL-STD-1800A, 4.3.23.1; MIL-  
STD-1472D, 5.9.16.1
- 6.15.2.3.4 MIL-STD-1800A, 4.3.23.2
- 6.15.2.3.5 MIL-STD-1472D, 5.9.16.2
- 6.15.2.4.1 UCRL-15673, 1.7.4.1.c.4
- 6.15.2.4.2 UCRL-15673, 1.7.4.1.c.4
- 6.15.2.4.3 UCRL-15673, 1.7.4.1.c.4
- 6.15.2.4.4 UCRL-15673, 1.7.4.1.c.4
- 6.15.2.4.5 UCRL-15673, 1.7.4.1.c.4
- 6.15.3 UCRL-15673, 1.8.3.1.d
- 6.15.4 UCRL-15673, 1.8.3.1.d, 1.8.2;  
AFSC DH 1-3, DN 2G5, 2.1-2.4
- 6.15.5 UCRL-15673, 1.8.3.1.d; AFSC  
DH 1-3, DN 2G5, 2.4
- 6.15.5.1 UCRL-15673, 1.8.3.1.d
- 6.15.6.1 AFSC DH 1-3, DN 2G5, 3.2.h
- 6.15.6.2 AFSC DH 1-3, DN 2G5, 3.2.i
- 6.15.6.3 AFSC DH 1-3, DN 2G5, 3.2.a
- 6.15.6.4 AFSC DH 1-3, DN 2G5, 3.2.b
- 6.15.6.5 AFSC DH 1-3, DN 2G5, 3.2.c
- 6.15.6.6 AFSC DH 1-3, DN 2G5, 3.2
- 6.15.6.7 AFSC DH 1-3, DN 2G5, 2.6.p
- 6.15.6.8 AFSC DH 1-3, DN 2G5, 3.2.e
- 6.15.6.9 AFSC DH 1-3, DN 2G5, 3.2.f
- 6.15.6.10 AFSC DH 1-3, DN 2G5, 3.2.g
- 6.15.7.1 AFSC DH 1-3, DN 2G5, 2.6.m
- 6.15.7.2 AFSC DH 1-3, DN 2G5, 2.6.n
- 6.15.7.3 AFSC DH 1-3, DN 2G5, 2.6.o
- 6.15.7.4 AFSC DH 1-3, DN 2G5, 2.6.r
- 6.16 MIL-HDBK-759B, 5.6.4.1.1,  
5.6.4.1.2
- 6.16.1.1 MIL-HDBK-759B, 5.6.4.1.2,  
5.6.4.2.b; NASA-STD-3000A,  
12.3.1.1.g
- 6.16.1.2 AFSC DH 1-3, DN 2G1; MIL-  
HDBK-759B, 5.6.4.2.a, 5.6.4.2.b
- 6.16.1.3 MIL-HDBK-759B, 5.6.4.2.a,  
5.6.4.2.b
- 6.16.1.4 MIL-STD-1472D, 5.9.1.2; MIL-  
STD-1800A, 4.3.1
- 6.16.2.1 MIL-HDBK-759B, 5.6.4.2.j
- 6.16.2.2 MIL-HDBK-759B, 5.6.4.2.j
- 6.16.2.3 MIL-HDBK-759B, 5.6.4.3.a
- 6.16.3.1 MIL-HDBK-759B, 5.6.4.1.2
- 6.16.3.3 MIL-HDBK-759B, 5.6.4.1.2
- 6.16.3.4 MIL-STD-1472D, 5.9.1.2; UCRL-  
15673, 1.5.3.1.e
- 6.16.3.5 MIL-HDBK-759B, 5.6.4.2.k
- 6.16.3.6 MIL-HDBK-759B, 5.6.4.3.b
- 7 SMEs 8, 9, 10, 11, 24.
- 7.1.1.1 MIL-STD-1472D, 5.1.1.1,  
5.1.1.2; DOE-STAND HFAC 1,  
2.1.1.1, 2.1.1.2; NUREG-0700,  
6.9.1.2
- 7.1.1.2 MIL-STD-1472D, 5.1.1.1; DOE-  
STAND HFAC 1, 2.1.1.1
- 7.1.1.3 MIL-STD-1472D, 5.1.1.3; DOE-  
STAND HFAC 1, 2.1.1.3
- 7.1.1.4 MIL-STD-1472D, 5.1.1.4; DOE-  
STAND HFAC 1, 2.1.1.4
- 7.1.1.5 NUREG-0700, 6.9.3.1.c; DOE-  
STAND HFAC 1, 2.1.1.5
- 7.1.1.6 MIL-STD-1472D, 5.1.1.5; DOE-  
STAND HFAC 1, 2.1.1.6
- 7.1.1.7 MIL-STD-1472D, 6.1.1.6; DOE-  
STAND HFAC 1, 2.1.1.7
- 7.1.1.8 MIL-STD-1472D, 5.1.2.3.8;  
DOE-STAND HFAC 1, 2.2.3.12
- 7.1.2.1 MIL-STD-1472D, 5.1.2.1; DOE-  
STAND HFAC 1, 2.2.1
- 7.1.2.2 MIL-STD-1472D, 5.1.2.1.1.1;  
DOE-STAND HFAC 1, 2.2.1.1
- 7.1.2.3 MIL-STD-1472D, 5.1.2.1.1.2;  
DOE-STAND HFAC 1, 2.2.1.2
- 7.1.2.4 MIL-STD-1472D, 5.1.2.1.1.3;  
DOE-STAND HFAC 1, 2.2.1.3
- 7.1.2.5 MIL-STD-1472D, 5.1.2.1.1.4;  
DOE-STAND HFAC 1, 2.2.1.4
- 7.1.2.6 MIL-STD-1472D, 5.1.2.2; DOE-  
STAND HFAC 1, 2.2.2
- 7.1.2.7 MIL-STD-1472D, 5.1.2.3; DOE-  
STAND HFAC 1, 2.2.3
- 7.1.2.8 NASA-STD-3000A, 9.2.3.2.3.c;  
DOE-STAND HFAC 1, 2.2.3.1
- 7.1.2.9 NASA-STD-3000A, 9.2.3.2.3;  
DOE-STAND HFAC 1, 2.2.3.2
- 7.1.2.10 MIL-STD-1472D, 5.1.2.3.1;  
DOE-STAND HFAC 1, 2.2.3.3
- 7.1.2.11 MIL-STD-1472D, 5.1.2.3.2;  
DOE-STAND HFAC 1, 2.2.3.3
- 7.1.2.12 MIL-STD-1472D, 5.1.2.3.3;  
DOE-STAND HFAC 1, 2.2.3.5
- 7.1.2.13 MIL-STD-1472D, 5.1.2.3.4;  
DOE-STAND HFAC 1, 2.2.3.6
- 7.1.2.14 MIL-STD-1472D, 5.1.2.3.5;  
DOE-STAND HFAC 1, 2.2.3.6
- 7.1.2.15 NUREG-0700, 6.9.2.3; DOE-  
STAND HFAC 1, 2.2.3.8
- 7.1.2.16 MIL-STD-1472D, 5.1.2.3.6;  
DOE-STAND HFAC 1, 2.2.3.9
- 7.1.2.17 MIL-STD-1472D, 5.1.2.3.6;  
DOE-STAND HFAC 1, 2.2.3.9;  
NUREG-0700, 6.9.2.3
- 7.1.2.18 MIL-STD-1472D, 5.1.2.3.7;  
DOE-STAND HFAC 1, 2.2.3.10
- 7.1.2.19 NUREG-0700, 6.9.1.2; DOE-  
STAND HFAC 1, 2.2.3.11
- 7.1.3.1 MIL-STD-1472D, 5.1.3.1; DOE-  
STAND HFAC 1, 2.3.1
- 7.1.3.2 MIL-STD-1472D, 5.1.3.2; DOE-  
STAND HFAC 1, 2.3.2
- 7.1.3.3 MIL-STD-1472D, 5.1.3.3; DOE-  
STAND HFAC 1, 2.2.3
- 7.1.3.4 MIL-STD-1472D, 5.1.3.4; DOE-  
STAND HFAC 1, 2.3.4

7.1.3.5	NUREG-0700, 6.9.3.1; DOE- STAND HFAC 1, 2.3.5	7.2.1.5.3	DOE-STAND HFAC 1, 3.1.6.3; NUREG-0700, 6.3.1.2
7.1.3.6	MIL-STD-1472D, 5.1.3.5; DOE- STAND HFAC 1, 2.3.6	7.2.1.5.4	DOE-STAND HFAC 1, 3.1.6.4
7.1.3.7	MIL-STD-1472D, 5.1.3.5; DOE- STAND HFAC 1, 2.3.6	7.2.1.5.5	DOE-STAND HFAC 1, 3.1.6.5
7.1.3.8	MIL-STD-1472D, 5.1.3.6; DOE- STAND HFAC 1, 2.3.7	7.2.1.5.6	DOE-STAND HFAC 1, 3.1.6.6; NUREG-0700, 6.3.1.4
7.1.3.9	MIL-STD-1472D, 5.1.3.7; DOE- STAND HFAC 1, 2.3.8	7.2.1.5.7	DOE-STAND HFAC 1, 3.1.6.9; NUREG-0700, 6.3.2.1
7.1.3.10	MIL-STD-1472D, 5.1.3.8; DOE- STAND HFAC 1, 2.3.9	7.2.1.5.8	DOE-STAND HFAC 1, 3.1.6.7
7.1.3.11	MIL-STD-1472D, 5.1.3.11; DOE- STAND HFAC 1, 2.3.12	7.2.1.5.9	DOE-STAND HFAC 1, 3.1.6.10; NUREG-0700, 6.3.3.4
7.1.3.12	MIL-STD-1472D, 5.1.3.10; DOE- STAND HFAC 1, 2.3.11	7.2.1.5.10	DOE-STAND HFAC 1, 3.1.6.10
7.1.4.1	MIL-STD-1472D, 5.1.4.1; DOE- STAND HFAC 1, 2.4.1	7.2.1.5.11	DOE-STAND HFAC 1, 3.1.6.11; MIL-STD-1472D, 5.3.6.2; NUREG-0700, 6.3.4.1
7.1.4.2	MIL-STD-1472D, 5.1.4.2; DOE- STAND HFAC 1, 2.4.2	7.2.1.5.12	DOE-STAND HFAC 1, 3.1.6.12
7.1.4.3	MIL-STD-1472D, 5.1.4.3; DOE- STAND HFAC 1, 2.4.3	7.2.1.5.13	DOE-STAND HFAC 1, 3.1.6.13; NUREG-0700, 6.3.4.1
7.1.4.4	MIL-STD-1472D, 5.1.4.4; DOE- STAND HFAC 1, 2.4.4	7.2.1.6.1	MIL-STD-1472D, 5.2.1.4.1; DOE-STAND HFAC 1, 3.1.7.1
7.1.4.5	MIL-STD-1472D, 5.1.4.5; DOE- STAND HFAC 1, 2.4.5	7.2.1.6.2	MIL-STD-1472D, 5.2.1.4.2; DOE-STAND HFAC 1, 3.1.7.2
7.1.4.6	MIL-STD-1472D, 5.1.4.5; DOE- STAND HFAC 1, 2.4.6	7.2.1.6.3	MIL-STD-1472D, 5.2.1.4.2; DOE-STAND HFAC 1, 3.1.7.3
7.1.4.7	MIL-STD-1472D, 5.1.4.5; DOE- STAND HFAC 1, 2.4.7	E7.2.1.6.3	Proposed MIL-STD-1472D, 5.2.1.3.3; MIL-STD-1472D, 5.2.1.4.3; MIL-HDBK-759B, 5.2.2.1.4.3; MIL-STD-1800A, 4.5.2.4.1.a
7.1.4.8	MIL-STD-1472D, 5.1.4.8; DOE- STAND HFAC 1, 2.4.8	7.2.1.6.4	MIL-STD-1472D, 5.2.1.4.4; DOE-STAND HFAC 1, 3.1.7.4
7.2.1.1.1	MIL-STD-1472D, 5.2.1; DOE- STAND HFAC 1, 3.1.1.1	7.2.1.6.5	MIL-STD-1472D, 5.2.1.4.5; DOE-STAND HFAC 1, 3.1.7.5
7.2.1.1.3	MIL-STD-1472D, 5.2.1.1; DOE- STAND HFAC 1, 3.1.1.2	7.2.1.6.6	MIL-STD-1472D, 5.2.1.4.6; DOE-STAND HFAC 1, 3.1.7.6
7.2.1.1.4	MIL-STD-1472D, 5.2.1.3.1; DOE-STAND HFAC 1, 3.1.1.3	7.2.1.6.7	MIL-STD-1472D, 5.2.1.4.7; DOE-STAND HFAC 1, 3.1.7.7
7.2.1.1.5	MIL-STD-1472D, 5.2.1.3.2; DOE-STAND HFAC 1, 3.1.1.4	7.2.1.6.8	MIL-STD-1472D, 5.2.1.4.8; DOE-STAND HFAC 1, 3.1.7.8
7.2.1.1.6	MIL-STD-1472D, 5.2.1.3.3; DOE-STAND HFAC 1, 3.1.1.5	E7.2.1.6.8	Proposed MIL-STD-1472D, 5.2.1.3.8; MIL-STD-1472D, 5.2.4.1.8; MIL-STD-1800A, 4.5.2.1.a
7.2.1.1.7	MIL-STD-1472D, 5.2.1.3.5; DOE-STAND HFAC 1, 3.1.1.6	7.2.1.6.9	MIL-STD-1472D, 5.2.1.4.9; DOE-STAND HFAC 1, 3.1.7.9
7.2.1.1.8	MIL-STD-1472D, 5.2.1.3.8; DOE-STAND HFAC 1, 3.1.1.7	7.2.1.6.10	MIL-STD-1472D, 5.2.1.4.10; DOE-STAND HFAC 1, 3.1.7.10
7.2.1.1.9	MIL-STD-1472D, 5.2.1.3.9; DOE-STAND HFAC 1, 3.1.1.8	7.2.1.6.11	MIL-STD-1472D, 5.2.1.4.11; DOE-STAND HFAC 1, 3.1.7.11
7.2.1.1.10	MIL-STD-1472D, 5.2.1.3.10; DOE-STAND HFAC 1, 3.1.1.9	7.2.1.6.12	MIL-STD-1472D, 5.2.1.4.12; DOE-STAND HFAC 1, 3.1.7.12
7.2.1.1.11	MIL-STD-1472D, 5.2.1.3.11; DOE-STAND HFAC 1, 3.1.1.10	7.2.1.6.13	MIL-STD-1472D, 5.2.1.4.12; DOE-STAND HFAC 1, 3.1.7.12
7.2.1.3.1	MIL-STD-1472D, 5.2.1.5.1; DOE-STAND HFAC 1, 3.1.4.1	7.2.1.6.14	MIL-STD-1472D, 5.2.4.2
7.2.1.3.2	MIL-STD-1472D, 5.2.1.5.2; DOE-STAND HFAC 1, 3.1.4.2	7.2.2	MIL-STD-1472D, 5.2.2.1; DOE- STAND HFAC 1, 3.2.1.1
7.2.1.3.3	MIL-STD-1472D, 5.2.1.5.3; DOE-STAND HFAC 1, 3.1.4.3	7.2.2.1.1	MIL-STD-1472D, 5.2.2.1.1, 5.2.2.1.3; DOE-STAND HFAC 1, 3.2.1.1
7.2.1.4.1	DOE-STAND HFAC 1, 3.1.5.1	7.2.2.1.2	MIL-STD-1472D, 5.2.2.1.2; DOE-STAND HFAC 1, 3.2.1.2
7.2.1.4.2	DOE-STAND HFAC 1, 3.1.5.1.1	7.2.2.1.3	MIL-STD-1472D, 5.2.2.1.4; DOE-STAND HFAC 1, 3.2.1.4
7.2.1.4.3	DOE-STAND HFAC 1, 3.1.5.1.2; MIL-STD-1472D, 5.2.1.3.13	7.2.2.1.4	MIL-STD-1472D, 5.2.2.1.4; DOE-STAND HFAC 1, 3.2.1.4
7.2.1.4.4	DOE-STAND HFAC 1, 3.1.5.1.3	7.2.2.1.5	MIL-STD-1472D, 5.2.2.1.5; DOE-STAND HFAC 1, 3.2.1.5
7.2.1.5.1	DOE-STAND HFAC 1, 3.1.1.2; MIL-STD-1472D, 5.2.1.1		
7.2.1.5.2	DOE-STAND HFAC 1, 3.1.6.2		

- 7.2.2.1.6 MIL-STD-1472D, 5.2.2.1.6;  
DOE-STAND HFAC 1, 3.2.1.6
- 7.2.2.1.7 MIL-STD-1472D, 5.2.2.1.7;  
DOE-STAND HFAC 1, 3.2.1.7
- 7.2.2.1.8 MIL-STD-1472D, 5.2.2.1.8;  
DOE-STAND HFAC 1, 3.2.1.8
- 7.2.2.1.9 MIL-STD-1472D, 5.2.2.1.9;  
DOE-STAND HFAC 1, 3.2.1.9
- 7.2.2.1.10 MIL-STD-1472D, 5.2.2.1.10;  
DOE-STAND HFAC 1, 3.2.1.10
- 7.2.2.1.11 MIL-STD-1472D, 5.2.2.1.11;  
DOE-STAND HFAC 1, 3.2.1.11
- 7.2.2.1.12 MIL-STD-1472D, 5.2.2.1.12;  
DOE-STAND HFAC 1, 3.2.1.12
- 7.2.2.1.13 MIL-STD-1472D, 5.2.2.1.12;  
DOE-STAND HFAC 1, 3.2.1.12
- 7.2.2.1.14 MIL-STD-1472D, 5.2.2.1.13;  
DOE-STAND HFAC 1, 3.2.1.13
- 7.2.2.1.15 MIL-STD-1472D, 5.2.2.1.14;  
DOE-STAND HFAC 1, 3.2.1.14
- 7.2.2.1.16 MIL-STD-1472D, 5.2.2.1.14;  
DOE-STAND HFAC 1, 3.2.1.14
- 7.2.2.1.17 MIL-STD-1472D, 5.2.2.1.15;  
DOE-STAND HFAC 1, 3.2.1.15
- 7.2.2.1.18 MIL-STD-1472D, 5.2.2.1.17;  
DOE-STAND HFAC 1, 3.2.1.17
- 7.2.2.1.19 MIL-STD-1472D, 5.2.2.1.17;  
DOE-STAND HFAC 1, 3.2.1.17
- 7.2.2.1.20 MIL-STD-1472D, 5.2.2.1.18;  
DOE-STAND HFAC 1, 3.2.1.18
- 7.2.2.1.21 MIL-STD-1472D, 5.2.2.1.19;  
DOE-STAND HFAC 1, 3.2.1.19
- 7.2.2.2.1 MIL-STD-1472D, 5.2.2.2.1;  
DOE-STAND HFAC 1, 3.2.2.1
- 7.2.2.2.2 MIL-STD-1472D, 5.2.2.2.2;  
DOE-STAND HFAC 1, 3.2.2.2
- 7.2.2.2.3 MIL-STD-1472D, 5.2.2.2.2;  
DOE-STAND HFAC 1, 3.2.2.2
- 7.2.2.2.4 MIL-STD-1472D, 5.2.2.2.3;  
DOE-STAND HFAC 1, 3.2.2.3
- 7.2.2.2.5 MIL-STD-1472D, 5.2.2.2.4;  
DOE-STAND HFAC 1, 3.2.2.4
- 7.2.2.2.6 MIL-STD-1472D, 5.2.2.2.5;  
DOE-STAND HFAC 1, 3.2.2.5
- 7.2.2.2.7 MIL-STD-1472D, 5.2.2.2.6;  
DOE-STAND HFAC 1, 3.2.2.6
- 7.2.2.3.1 MIL-STD-1472D, 5.2.2.3.1;  
DOE-STAND HFAC 1, 3.2.3.1
- 7.2.2.3.2 MIL-STD-1472D, 5.2.2.3.2;  
DOE-STAND HFAC 1, 3.2.3.2
- 7.2.2.3.3 MIL-STD-1472D, 5.2.2.3.3;  
DOE-STAND HFAC 1, 3.2.3.3
- 7.2.2.4.1 MIL-STD-1472D, 5.2.2.4.1;  
DOE-STAND HFAC 1, 3.2.4.1
- 7.2.2.4.2 MIL-STD-1472D, 5.2.2.4.2;  
DOE-STAND HFAC 1, 3.2.4.2
- 7.2.2.4.3 MIL-STD-1472D, 5.2.2.4.3;  
DOE-STAND HFAC 1, 3.2.4.3
- 7.2.2.4.4 MIL-STD-1472D, 5.2.2.4.4;  
DOE-STAND HFAC 1, 3.2.4.4
- 7.2.3.1 MIL-STD-1472D, 5.2.3.1.1;  
DOE-STAND HFAC 1, 3.3.1.1
- 7.2.3.1.1 MIL-STD-1472D, 5.2.3.1.2;  
DOE-STAND HFAC 1, 3.3.1.2
- 7.2.3.1.2 MIL-STD-1472D, 5.2.3.1.3;  
DOE-STAND HFAC 1, 3.3.1.3
- 7.2.3.1.3 MIL-STD-1472D, 5.2.3.1.4;  
DOE-STAND HFAC 1, 3.3.1.4
- 7.2.3.1.4 MIL-STD-1472D, 5.2.3.1.5.1;  
DOE-STAND HFAC 1, 3.3.1.5.1
- 7.2.3.1.5 MIL-STD-1472D, 5.2.3.1.5.2;  
DOE-STAND HFAC 1, 3.3.1.5.2
- 7.2.3.1.6 MIL-STD-1472D, 5.2.3.1.6.1;  
DOE-STAND HFAC 1, 3.3.1.6.1
- 7.2.3.1.7 MIL-STD-1472D, 5.2.3.1.6.2;  
DOE-STAND HFAC 1, 3.3.1.6.2
- 7.2.3.1.8 MIL-STD-1472D, 5.2.3.1.7.1;  
DOE-STAND HFAC 1, 3.3.1.7.1
- 7.2.3.1.9 MIL-STD-1472D, 5.2.3.1.7.2;  
DOE-STAND HFAC 1, 3.3.1.7.2
- 7.2.3.1.10 MIL-STD-1472D, 5.2.3.1.7.3;  
DOE-STAND HFAC 1, 3.3.1.7.3
- 7.2.3.1.11 MIL-STD-1472D, 5.2.3.1.7.4;  
DOE-STAND HFAC 1, 3.3.1.7.4
- 7.2.3.1.12 MIL-STD-1472D, 5.2.3.1.8;  
DOE-STAND HFAC 1, 3.3.1.8
- 7.2.3.1.13 MIL-STD-1472D, 5.2.3.1.9;  
DOE-STAND HFAC 1, 3.3.1.8
- 7.2.3.1.14 MIL-STD-1472D, 5.2.3.1.10.1;  
DOE-STAND HFAC 1,  
3.3.1.10.1
- 7.2.3.1.15 MIL-STD-1472D, 5.2.3.1.10.2;  
DOE-STAND HFAC 1,  
3.3.1.10.2
- 7.2.3.1.16 MIL-STD-1472D, 5.2.3.1.10.3;  
DOE-STAND HFAC 1,  
3.3.1.10.3
- 7.2.3.1.17 MIL-STD-1472D, 5.2.3.1.10.4;  
DOE-STAND HFAC 1,  
3.3.1.10.4
- 7.2.3.2.1 MIL-STD-1472D, 5.2.3.2.1;  
DOE-STAND HFAC 1, 3.3.2.1
- 7.2.3.2.2 MIL-STD-1472D, 5.2.3.2.2;  
DOE-STAND HFAC 1, 3.3.2.2
- 7.2.3.2.3 MIL-STD-1472D, 5.2.3.2.3.1,  
5.2.3.2.4.1; DOE-STAND HFAC  
1, 3.3.2.3.1, 3.3.2.4.1
- 7.2.3.2.4 MIL-STD-1472D, 5.2.3.2.3.2;  
DOE-STAND HFAC 1, 3.3.2.3.2
- 7.2.3.2.5 MIL-STD-1472D, 5.2.3.2.3.5;  
DOE-STAND HFAC 1, 3.3.2.3.5
- 7.2.3.2.6 MIL-STD-1472D, 5.2.3.2.3.3;  
DOE-STAND HFAC 1, 3.3.2.3.3
- 7.2.3.2.7 MIL-STD-1472D, 5.2.3.2.3.4;  
DOE-STAND HFAC 1, 3.3.2.3.4
- 7.2.3.2.8 MIL-STD-1472D, 5.2.3.2.4.5;  
DOE-STAND HFAC 1, 3.3.2.4.5
- 7.2.3.2.9 MIL-STD-1472D, 5.2.3.2.3.6;  
DOE-STAND HFAC 1, 3.3.2.3.6
- 7.2.3.2.10 MIL-STD-1472D, 5.2.3.2.4.3;  
DOE-STAND HFAC 1, 3.3.2.4.3
- 7.2.3.2.11 MIL-STD-1472D, 5.2.3.2.4.4;  
DOE-STAND HFAC 1, 3.3.2.4.4
- 7.2.3.3.1 MIL-STD-1472D, 5.2.3.1.2;  
DOE-STAND HFAC 1, 3.3.1.2
- 7.2.3.3.2 MIL-STD-1472D, 5.2.3.3.2;  
DOE-STAND HFAC 1, 3.3.3.1
- 7.2.3.3.3 MIL-STD-1472D, 5.2.3.3.2;  
DOE-STAND HFAC 1, 3.3.3.2
- 7.2.3.3.4 MIL-STD-1472D, 5.2.3.3.3;  
DOE-STAND HFAC 1, 3.3.3.3

- 7.2.3.3.5 MIL-STD-1472D, 5.2.3.3.4;  
DOE-STAND HFAC 1, 3.3.3.4
- 7.2.3.3.6 MIL-STD-1472D, 5.2.3.3.5;  
DOE-STAND HFAC 1, 3.3.3.5
- 7.2.3.3.7 MIL-STD-1472D, 5.2.3.3.6;  
DOE-STAND HFAC 1, 3.3.3.6
- 7.2.3.3.8 MIL-STD-1472D, 5.2.3.3.7;  
DOE-STAND HFAC 1, 3.3.3.7
- 7.2.4.1.1 DOE-STAND HFAC 1, 3.4.1
- 7.2.4.1.2 DOE-STAND HFAC 1, 3.4.3
- 7.2.4.1.3 DOE-STAND HFAC 1, 3.4.4
- 7.2.4.1.4 DOE-STAND HFAC 1, 3.4.5
- 7.2.4.1.5 DOE-STAND HFAC 1, 3.4.6
- 7.2.4.2.1 DOE-STAND HFAC 1, 3.4.2.1
- 7.2.4.2.2 DOE-STAND HFAC 1, 3.4.2.2
- 7.2.4.2.3 DOE-STAND HFAC 1, 3.4.2.3
- 7.2.4.2.4 DOE-STAND HFAC 1, 3.4.2.4;  
NUREG-0700, 6.7.2.7;  
ANSI/HFS 100-1988, 6.6
- 7.2.4.3.1 MIL-STD-1472D, 5.2.4.3; DOE-  
STAND HFAC 1, 3.4.7.1
- 7.2.4.3.2 MIL-STD-1472D, 5.2.4.4; DOE-  
STAND HFAC 1, 3.4.7.2
- 7.2.4.3.3 MIL-STD-1472D, 5.2.4.5; DOE-  
STAND HFAC 1, 3.4.7.3
- 7.2.4.3.4 MIL-STD-1472D, 5.2.4.6; DOE-  
STAND HFAC 1, 3.4.7.4
- 7.2.4.3.5 NUREG-0700, 6.7.2.1; DOE-  
STAND HFAC 1, 3.4.7.5,  
3.4.10.3
- 7.2.4.4.1 MIL-STD-1472D, 5.2.4.7;  
ANSI/HFS 100-1988, 6.12; DOE-  
STAND HFAC 1, 3.4.8.1
- 7.2.4.4.2 FAA-STD-001B, MIL-STD-  
1472D, 5.2.4.8; DOE-STAND  
HFAC 1, 3.4.8.2
- 7.2.4.5.1 MIL-STD-1472D, 5.2.4.2; DOE-  
STAND HFAC 1, 3.4.9.1
- 7.2.4.5.2 MIL-STD-1472D, 5.2.4.2; DOE-  
STAND HFAC 1, 3.4.9.1
- 7.2.4.5.3 DOE-STAND HFAC 1, 3.4.9.2
- 7.2.4.5.4 New; ANSI/HFS 100-1988
- 7.2.4.6.1 DOE-STAND HFAC 1, 3.4.10.1;  
NUREG-0700, 6.7.2.2; MIL-STD-  
1472D, 5.2.4.10
- 7.2.4.6.2 DOE-STAND HFAC 1, 3.4.10.2
- 7.2.4.6.3 DOE-STAND HFAC 1, 3.4.10.3
- 7.2.4.6.4 DOE-STAND HFAC 1, 3.4.10.3,  
3.4.7.5; NUREG-0700, 6.7.2.1
- 7.2.4.6.5 DOE-STAND HFAC 1, 3.4.10.4
- 7.2.4.7.1 DOE-STAND HFAC 1, 3.4.11.1;  
MIL-STD-1472D, 5.2.4.9
- 7.2.4.7.2 DOE-STAND HFAC 1, 3.4.11.2;  
MIL-STD-1472D, 5.2.4.1
- 7.2.4.7.3 DOE-STAND HFAC 1, 3.4.11.3;  
NUREG-0700, 6.7.2.1
- 7.2.4.7.4 DOE-STAND HFAC 1, 3.4.11.4;
- 7.2.4.7.5 DOE-STAND HFAC 1, 3.4.11.5;
- 7.2.4.7.6 DOE-STAND HFAC 1, 3.4.11.6;
- 7.2.4.7.7 DOE-STAND HFAC 1, 3.4.11.7;
- 7.2.4.7.8 DOE-STAND HFAC 1, 3.4.11.8;
- 7.2.4.7.9 DOE-STAND HFAC 1, 3.4.11.9;
- 7.2.5.1.2 DOE-STAND HFAC 1, 3.5.1.2
- 7.2.5.1.3 DOE-STAND HFAC 1, 3.5.1.3
- 7.2.5.1.4 DOE-STAND HFAC 1, 3.5.1.4
- 7.2.5.1.5 DOE-STAND HFAC 1, 3.5.1.5
- 7.2.5.1.6 DOE-STAND HFAC 1, 3.5.1.6
- 7.2.5.2.1 DOE-STAND HFAC 1, 3.5.2.1;  
MIL-STD-1472D, 5.2.6.6.1
- 7.2.5.2.2 DOE-STAND HFAC 1, 3.5.2.2;  
MIL-STD-1472D, 5.2.6.6.2
- 7.2.5.2.3 DOE-STAND HFAC 1, 3.5.2.2;  
MIL-STD-1472D, 5.2.6.6.2
- 7.2.5.2.4 DOE-STAND HFAC 1, 3.5.2.3;  
MIL-STD-1472D, 5.2.6.6.3
- 7.2.5.2.5 DOE-STAND HFAC 1, 3.5.2.4.1;  
MIL-STD-1472D, 5.2.6.6.4.1
- 7.2.5.2.6 DOE-STAND HFAC 1, 3.5.2.4.2;  
MIL-STD-1472D, 5.2.6.6.4.2
- 7.2.5.2.7 MIL-STD-1472D, 5.2.6.6.4.3.1
- 7.2.5.2.8 DOE-STAND HFAC 1, 3.5.2.5;  
MIL-STD-1472D, 5.2.6.6.4.3.1
- 7.2.5.2.9 DOE-STAND HFAC 1, 3.5.2.5.1;  
MIL-STD-1472D, 5.2.6.6.4.3.2
- 7.2.5.2.10 DOE-STAND HFAC 1, 3.5.2.6;  
MIL-STD-1472D, 5.2.6.6.4.4
- 7.2.5.2.11 DOE-STAND HFAC 1, 3.5.2.7;  
MIL-STD-1472D, 5.2.6.6.5
- 7.2.6.1 MIL-STD-1472D, 5.2.6.8.2;  
DOE-STAND HFAC 1, 3.6.1
- 7.2.6.2 MIL-STD-1472D, 5.2.6.8.3;  
DOE-STAND HFAC 1, 3.6.2.6
- 7.2.6.3 MIL-STD-1472D, 5.2.6.8.4;  
DOE-STAND HFAC 1, 3.6.3.3
- 7.2.6.4 MIL-STD-1472D, 5.2.6.8.6;  
DOE-STAND HFAC 1, 3.6.3.5
- 7.2.6.5 MIL-STD-1472D, 5.2.6.8.7;  
DOE-STAND HFAC 1, 3.6.3.6
- 7.2.6.6 MIL-STD-1472D, 5.2.6.8.8;  
DOE-STAND HFAC 1, 3.6.3.7
- 7.2.7.1 MIL-STD-1472D, 5.2.6.7.1;  
DOE-STAND HFAC 1, 3.6.2.1
- 7.2.7.2 MIL-STD-1472D, 5.2.6.7.3;  
DOE-STAND HFAC 1, 3.6.2.2
- 7.2.7.3 MIL-STD-1472D, 5.2.6.7.3;  
DOE-STAND HFAC 1, 3.6.2.3
- 7.2.7.4 MIL-STD-1472D, 5.2.6.7.4;  
DOE-STAND HFAC 1, 3.6.2.4
- 7.2.7.5 MIL-STD-1472D, 5.2.6.7.5;  
DOE-STAND HFAC 1, 3.6.2.5
- 7.2.7.6 MIL-STD-1472D, 5.2.6.8.10;  
DOE-STAND HFAC 1, 3.6.2.6
- 7.2.8.1 DOE HFDG ATCCS, V2.0, 16.1
- 7.2.8.1.1 DOE HFDG ATCCS, V2.0,  
16.1.1.1
- 7.2.8.1.2 DOE HFDG ATCCS, V2.0,  
16.1.1.2
- 7.2.8.1.3 DOE HFDG ATCCS, V2.0,  
16.1.1.3
- 7.2.8.1.4 DOE HFDG ATCCS, V2.0,  
16.1.1.4
- 7.2.8.1.5 DOE HFDG ATCCS, V2.0,  
16.1.3
- 7.2.8.1.6 DOE HFDG ATCCS, V2.0,  
16.1.4.4
- 7.2.8.1.7 DOE HFDG ATCCS, V2.0,  
16.1.4.3
- 7.2.8.1.8 DOE HFDG ATCCS, V2.0,  
16.1.5
- 7.2.8.1.9 DOE HFDG ATCCS, V2.0,  
16.5.3
- 7.2.8.2 DOE HFDG ATCCS, V2.0, 16.2
- 7.2.8.2.1 DOE HFDG ATCCS, V2.0,  
16.2.1



- 7.2.8.2.2 DOE HFDG ATCCS, V2.0, 16.2.2
- 7.2.8.2.3 DOE HFDG ATCCS, V2.0, 16.2.3
- 7.2.8.2.4 DOE HFDG ATCCS, V2.0, 16.2.1.2
- 7.2.8.2.5 DOE HFDG ATCCS, V2.0, 16.2.4
- 7.2.8.3.1 DOE HFDG ATCCS, V2.0, 16.3.2
- 7.2.8.3.2 DOE HFDG ATCCS, V2.0, 16.3.1
- 7.2.8.4 DOE HFDG ATCCS, V2.0, 16.4
- 7.2.8.4.1 DOE HFDG ATCCS, V2.0, 16.4
- 7.2.8.4.2 DOE HFDG ATCCS, V2.0, 16.4
- 7.2.8.4.3 DOE HFDG ATCCS, V2.0, 16.4.2
- 7.2.8.4.4 DOE HFDG ATCCS, V2.0, 16.4.1
- 7.2.8.5 DOE HFDG ATCCS, V2.0, 16.7
- 7.2.8.5.1 DOE HFDG ATCCS, V2.0, 16.7
- 7.2.8.5.2 DOE HFDG ATCCS, V2.0, 16.7.1
- 7.2.8.5.3 DOE HFDG ATCCS, V2.0, 16.7.3
- 7.2.8.5.4 DOE HFDG ATCCS, V2.0, 16.7.4
- 7.2.8.5.5 DOE HFDG ATCCS, V2.0, 16.7.6
- 7.2.8.5.6 DOE HFDG ATCCS, V2.0, 16.7.7
- 7.2.8.5.7 DOE HFDG ATCCS, V2.0, 16.7.8
- 7.2.8.5.8 DOE HFDG ATCCS, V2.0, 16.7.9
- 7.2.8.6 DOE HFDG ATCCS, V2.0, 16.8
- 7.2.8.6.1 DOE HFDG ATCCS, V2.0, 16.8.1
- 7.2.8.6.2 DOE HFDG ATCCS, V2.0, 16.8.2
- 7.2.9.1.1 MIL-STD-1472D, 5.2.6.2.1; DOE-STAND HFAC 1, 3.2.8.1
- 7.2.9.1.2 MIL-STD-1472D, 5.2.6.2.2; DOE-STAND HFAC 1, 3.8.2.2
- 7.2.9.1.3 d. MIL-STD-1472D, 5.2.6.2.4; DOE-STAND HFAC 1, 3.8.2.4
- 7.2.9.1.4 MIL-STD-1472D, 5.2.6.2.5; DOE-STAND HFAC 1, 3.8.2.5
- 7.2.9.1.5 MIL-STD-1472D, 5.2.6.2.3; DOE-STAND HFAC 1, 3.8.2.3
- 7.2.9.1.6 FAA-STD-001B; MIL-STD-1472D, 5.2.6.2.6; DOE-STAND HFAC 1, 3.8.2.6
- 7.2.9.1.7 MIL-STD-1472D, 5.2.6.2.7; DOE-STAND HFAC 1, 3.8.2.7
- 7.2.9.2.1 MIL-STD-1472D, 5.2.6.3.1; DOE-STAND HFAC 1, 3.8.3.1
- 7.2.9.2.2 MIL-STD-1472D, 5.2.6.3.3; DOE-STAND HFAC 1, 3.8.3.3
- 7.2.9.2.3 MIL-STD-1472D, 5.2.6.3.4; DOE-STAND HFAC 1, 3.8.3.4
- 7.2.9.2.4 MIL-STD-1472D, 5.2.6.3.5; DOE-STAND HFAC 1, 3.8.3.5
- 7.2.9.2.5 MIL-STD-1472D, 5.2.6.3.6; DOE-STAND HFAC 1, 3.8.3.6
- 7.2.9.2.6 MIL-STD-1472D, 5.2.6.3.7; DOE-STAND HFAC 1, 3.8.3.7
- 7.2.9.2.7 MIL-STD-1472D, 5.2.6.3.8; DOE-STAND HFAC 1, 3.8.3.8
- 7.2.9.2.8 MIL-STD-1472D, 5.2.6.3.9; DOE-STAND HFAC 1, 3.8.3.9
- 7.2.9.3.1 MIL-STD-1472D, 5.2.6.4.1; DOE-STAND HFAC 1, 3.8.4.1
- 7.2.9.3.2 MIL-STD-1472D, 5.2.6.4.2; DOE-STAND HFAC 1, 3.8.4.2
- 7.2.9.3.3 MIL-STD-1472D, 5.2.6.4.3; DOE-STAND HFAC 1, 3.8.4.3
- 7.2.9.3.4 MIL-STD-1472D, 5.2.6.4.4; DOE-STAND HFAC 1, 3.8.4.4
- 7.2.9.3.5 MIL-STD-1472D, 5.2.6.4.5; DOE-STAND HFAC 1, 3.8.4.5
- 7.2.9.3.6 MIL-STD-1472D, 5.2.6.4.6; DOE-STAND HFAC 1, 3.8.4.6
- 7.2.9.3.7 MIL-STD-1472D, 5.2.6.4.7; DOE-STAND HFAC 1, 3.8.4.7
- 7.2.9.3.8 MIL-STD-1472D, 5.2.6.4.8; DOE-STAND HFAC 1, 3.8.4.8
- 7.2.9.4.1 MIL-STD-1472D, 5.2.6.5.1; DOE-STAND HFAC 1, 3.8.5.1
- 7.2.9.4.2 MIL-STD-1472D, 5.2.6.5.2; DOE-STAND HFAC 1, 3.8.5.2
- 7.2.9.4.3 MIL-STD-1472D, 5.2.6.5.3; DOE-STAND HFAC 1, 3.8.5.3
- 7.2.9.4.4 MIL-STD-1472D, 5.2.6.5.4; DOE-STAND HFAC 1, 3.8.5.4
- 7.2.9.4.5 MIL-STD-1472D, 5.2.6.5.5; DOE-STAND HFAC 1, 3.8.5.5
- 7.2.9.4.6 MIL-STD-1472D, 5.2.6.5.6; DOE-STAND HFAC 1, 3.8.5.6
- 7.2.9.4.7 MIL-STD-1472D, 5.2.6.5.7; DOE-STAND HFAC 1, 3.8.5.7
- 7.3.1.1 MIL-STD-1472D, 5.3.1.7; DOE-STAND HFAC 1, 4.1.1.2
- 7.3.1.2 MIL-STD-1472D, 5.3.1.1; DOE-STAND HFAC 1, 4.1.1.1
- 7.3.1.3 DOE-STAND HFAC 1, 4.1.1.3
- 7.3.1.4 MIL-STD-1472D, 5.3.1.3; DOE-STAND HFAC 1, 4.1.2.1
- 7.3.1.5 MIL-STD-1472D, 5.3.1.4; DOE-STAND HFAC 1, 4.1.2.2
- 7.3.1.6 MIL-STD-1472D, 5.3.1.5; DOE-STAND HFAC 1, 4.1.2.3
- 7.3.1.7 MIL-STD-1472D, 5.3.4.3; DOE-STAND HFAC 1, 4.4.1.3
- 7.3.2.1.1 MIL-STD-1472D, 5.3.2.1; DOE-STAND HFAC 1, 4.2.1.1
- 7.3.2.1.2 MIL-STD-1472D, 5.3.2.1; DOE-STAND HFAC 1, 4.2.1.1
- 7.3.2.2.1 MIL-STD-1472D, 5.3.2.2; DOE-STAND HFAC 1, 4.2.2.1
- 7.3.2.2.2 MIL-STD-1472D, 5.3.2.2.1; DOE-STAND HFAC 1, 4.2.2.1.1
- 7.3.2.2.3 MIL-STD-1472D, 5.3.2.2.2; DOE-STAND HFAC 1, 4.2.2.1.2
- 7.3.2.2.4 MIL-STD-1472D, 5.3.2.3; DOE-STAND HFAC 1, 4.2.2.2
- 7.3.2.2.5 MIL-STD-1472D, 5.3.2.4; DOE-STAND HFAC 1, 4.2.2.3
- 7.3.2.2.6 MIL-STD-1472D, 5.3.3.1.1; DOE-STAND HFAC 1, 4.2.2.4
- 7.3.2.2.7 MIL-STD-1472D, 5.3.3.1.2; DOE-STAND HFAC 1, 4.2.2.4.1

- 7.3.2.2.8 MIL-STD-1472D, 5.3.3.2.1; DOE-STAND HFAC 1, 4.2.2.5.1; NUREG-0700, 6.2.2.6
- 7.3.2.2.9 MIL-STD-1472D, 5.3.3.2.2; DOE-STAND HFAC 1, 4.2.2.5.2
- 7.3.2.3.1 MIL-STD-1472D, 5.3.4.1; NUREG-0700, 6.2.2.6
- 7.3.2.3.2 MIL-STD-1472D, 5.3.4.1; NUREG-0700, 6.2.2.6
- 7.3.2.3.3 MIL-STD-1472D, 5.3.4.2.1; DOE-STAND HFAC 1, 4.2.3.2.1
- 7.3.2.3.4 MIL-STD-1472D, 5.3.4.2.2; DOE-STAND HFAC 1, 4.2.3.2.2
- 7.3.2.3.5 MIL-STD-1472D, 5.3.4.2.3; DOE-STAND HFAC 1, 4.2.3.2.3
- 7.3.2.3.6 MIL-STD-1472D, 5.3.4.2.4; DOE-STAND HFAC 1, 4.2.3.2.4
- 7.3.2.3.7 MIL-STD-1472D, 5.3.4.2.4; DOE-STAND HFAC 1, 4.2.3.2.4
- 7.3.2.3.8 MIL-STD-1472D, 5.3.4.3.1; DOE-STAND HFAC 1, 4.2.3.3.1
- 7.3.2.3.9 MIL-STD-1472D, 5.3.4.3.2; DOE-STAND HFAC 1, 4.2.3.3.2
- 7.3.2.3.10 MIL-STD-1472D, 5.3.4.3.5; DOE-STAND HFAC 1, 4.2.3.3.5
- 7.3.2.3.11 MIL-STD-1472D, 5.3.4.4.1; DOE-STAND HFAC 1, 4.2.3.4.1
- 7.3.2.3.12 MIL-STD-1472D, 5.3.4.4.2; DOE-STAND HFAC 1, 4.2.3.4.2
- 7.3.2.3.13 MIL-STD-1472D, 5.3.4.5.1; DOE-STAND HFAC 1, 4.2.3.5.1
- 7.3.2.3.14 MIL-STD-1472D, 5.3.4.5.2; DOE-STAND HFAC 1, 4.2.3.5.2
- 7.3.3.1 MIL-STD-1472D, 5.3.5.1; DOE-STAND HFAC 1, 4.3.1.1
- 7.3.3.2 NUREG-0700, 6.2.2.6; MIL-STD-1472D, 5.3.5.2; DOE-STAND HFAC 1, 4.3.1.2
- 7.3.3.3 MIL-STD-1472D, 5.3.5.3.1; DOE-STAND HFAC 1, 4.3.1.3
- 7.3.3.4 MIL-STD-1472D, 5.3.5.3.2; DOE-STAND HFAC 1, 4.3.1.4
- 7.3.3.5 MIL-STD-1472D, 5.3.5.4; DOE-STAND HFAC 1, 4.3.2.1
- 7.3.3.6 MIL-STD-1472D, 5.3.5.5; DOE-STAND HFAC 1, 4.3.2.2
- 7.3.3.7 MIL-STD-1472D, 5.3.5.6.1; DOE-STAND HFAC 1, 4.3.3.1
- 7.3.3.8 MIL-STD-1472D, 5.3.5.6.2; DOE-STAND HFAC 1, 4.3.3.2
- 7.3.4.1.1 MIL-STD-1472D, 5.3.6.1; DOE-STAND HFAC 1, 4.4.1.1
- 7.3.4.1.2 MIL-STD-1472D, 5.3.6.2; DOE-STAND HFAC 1, 4.4.1.2
- 7.3.4.2.1 MIL-STD-1472D, 5.3.6.4.1; DOE-STAND HFAC 1, 4.4.2.1
- 7.3.4.2.2 MIL-STD-1472D, 5.3.6.4.2; DOE-STAND HFAC 1, 4.4.2.2
- 7.3.4.2.3 MIL-STD-1472D, 5.3.6.4.3; DOE-STAND HFAC 1, 4.4.2.3
- 7.3.4.2.4 MIL-STD-1472D, 5.3.6.5; DOE-STAND HFAC 1, 4.4.2.4
- 7.3.4.2.5 MIL-STD-1472D, 5.3.6.6; DOE-STAND HFAC 1, 4.4.2.5
- 7.3.5.1.1 MIL-STD-1472D, 5.3.7.1; DOE-STAND HFAC 1, 4.5.1.1
- 7.3.5.1.2 MIL-STD-1472D, 5.3.7.2; DOE-STAND HFAC 1, 4.5.1.2
- 7.3.5.1.3 MIL-STD-1472D, 5.3.7.3; DOE-STAND HFAC 1, 4.5.1.3
- 7.3.5.1.4 MIL-STD-1472D, 5.3.7.4, 5.3.7.5; DOE-STAND HFAC 1, 4.5.1.4, 4.5.1.5
- 7.3.5.1.5 MIL-STD-1472D, 5.3.7.6; DOE-STAND HFAC 1, 4.5.1.6
- 7.3.5.2.1 MIL-STD-1472D, 5.3.8.1; DOE-STAND HFAC 1, 4.5.2.1
- 7.3.5.2.2 MIL-STD-1472D, 5.3.8.3; DOE-STAND HFAC 1, 4.5.2.2
- 7.3.5.2.3 MIL-STD-1472D, 5.3.8.2.1; DOE-STAND HFAC 1, 4.5.2.3.1
- 7.3.5.2.4 MIL-STD-1472D, 5.3.8.2.2; DOE-STAND HFAC 1, 4.5.2.3.2
- 7.3.5.2.5 MIL-STD-1472D, 5.3.8.4; DOE-STAND HFAC 1, 4.5.2.4
- 7.3.5.2.6 MIL-STD-1472D, 5.3.8.4; DOE-STAND HFAC 1, 4.5.2.4
- 7.3.5.3.1 MIL-STD-1472D, 5.3.9.1; DOE-STAND HFAC 1, 4.5.3.1
- 7.3.5.3.2 MIL-STD-1472D, 5.3.9.2; DOE-STAND HFAC 1, 4.5.3.2
- 7.3.5.3.3 MIL-STD-1472D, 5.3.9.3; DOE-STAND HFAC 1, 4.5.3.3
- 7.3.5.4.1 MIL-STD-1472D, 5.3.10.1; DOE-STAND HFAC 1, 4.5.4.1
- 7.3.5.4.2 MIL-STD-1472D, 5.3.10.1; DOE-STAND HFAC 1, 4.5.4.1
- 7.3.5.4.3 MIL-STD-1472D, 5.3.10.1; DOE-STAND HFAC 1, 4.5.4.1
- 7.3.5.4.4 MIL-STD-1472D, 5.3.10.2; DOE-STAND HFAC 1, 4.5.4.2
- 7.3.5.4.5 MIL-STD-1472D, 5.3.10.3; DOE-STAND HFAC 1, 4.5.4.3
- 7.3.5.4.6 MIL-STD-1472D, 5.3.10.3; DOE-STAND HFAC 1, 4.5.4.3
- 7.3.5.4.7 MIL-STD-1472D, 5.3.11; DOE-STAND HFAC 1, 4.5.4.4
- 7.3.5.5.1 NUREG-0700, 6.2.1.2; DOE-STAND HFAC 1, 4.5.5.1
- 7.3.5.5.2 NUREG-0700, 6.2.1.2; DOE-STAND HFAC 1, 4.5.5.2
- 7.3.5.5.3 NUREG-0700, 6.2.1.2; DOE-STAND HFAC 1, 4.5.5.3
- 7.3.5.5.4 NUREG-0700, 6.2.1.2; DOE-STAND HFAC 1, 4.5.5.4
- 7.3.5.5.5 NUREG-0700, 6.2.1.2; DOE-STAND HFAC 1, 4.5.5.5
- 7.3.5.5.6 NUREG-0700, 6.2.1.2; DOE-STAND HFAC 1, 4.5.5.6
- 7.3.5.5.7 NUREG-0700, 6.2.1.2; DOE-STAND HFAC 1, 4.5.5.6
- 7.3.5.5.8 NUREG-0700, 6.2.1.2; DOE-STAND HFAC 1, 4.5.5.7
- 7.3.5.6.1 MIL-STD-1472D, 5.3.12.1; DOE-STAND HFAC 1, 4.5.6.1
- 7.3.5.6.2 MIL-STD-1472D, 5.3.12.2; DOE-STAND HFAC 1, 4.5.6.2
- 7.4.1.1.1 MIL-STD-1472D, 5.4.1.1.1; DOE-STAND HFAC 1, 5.1.1.1
- 7.4.1.1.2 MIL-STD-1472D, 5.4.1.1.3; DOE-STAND HFAC 1, 5.1.1.3
- 7.4.1.1.3 MIL-STD-1472D, 5.4.1.1.4; DOE-STAND HFAC 1, 5.1.1.4

- 7.4.1.1.4 MIL-STD-1472D, 5.4.1.1.5;  
DOE-STAND HFAC 1, 5.1.1.5
- 7.4.1.1.5 DOE-STAND HFAC 1, 5.1.1.6
- E7.4.1.1.5 Van Cott & Kinkade, pg. 359
- 7.4.1.2.1 MIL-STD-1472D, 5.4.1.2.1;  
DOE-STAND HFAC 1, 5.1.2.1
- 7.4.1.2.2 MIL-STD-1472D, 5.4.1.2.4;  
DOE-STAND HFAC 1, 5.1.2.2
- 7.4.1.2.3 MIL-STD-1472D, 5.4.1.2.4;  
DOE-STAND HFAC 1, 5.1.2.2
- 7.4.1.3.1 MIL-STD-1472D, 5.4.1.3.1;  
DOE-STAND HFAC 1, 5.1.3.1
- 7.4.1.3.2 MIL-STD-1472D, 5.4.1.3.2;  
DOE-STAND HFAC 1, 5.1.3.2
- 7.4.1.3.3 MIL-STD-1472D, 5.4.1.3.3;  
DOE-STAND HFAC 1, 5.1.3.3
- 7.4.1.3.4 MIL-STD-1472D, 5.4.1.3.4;  
DOE-STAND HFAC 1, 5.1.3.4
- 7.4.1.3.5 MIL-STD-1472D, 5.4.1.3.5;  
DOE-STAND HFAC 1, 5.1.3.5
- 7.4.1.3.6 MIL-STD-1472D, 5.4.1.3.6;  
DOE-STAND HFAC 1, 5.1.3.6
- 7.4.1.3.7 MIL-STD-1472D, 5.4.1.3.7;  
DOE-STAND HFAC 1, 5.1.3.7
- 7.4.1.4.1 MIL-STD-1472D, 5.4.1.4.1;  
DOE-STAND HFAC 1, 5.1.4.1
- 7.4.1.4.2 MIL-STD-1472D, 5.4.1.4.2;  
DOE-STAND HFAC 1, 5.1.4.2
- 7.4.1.4.3 MIL-STD-1472D, 5.4.1.4.3;  
DOE-STAND HFAC 1, 5.1.4.3
- 7.4.1.4.5 MIL-STD-1472D, 5.4.1.4.5.1;  
DOE-STAND HFAC 1, 5.1.4.5.1
- 7.4.1.4.6 MIL-STD-1472D, 5.4.1.4.5.3;  
DOE-STAND HFAC 1, 5.1.4.5.2
- 7.4.1.4.7 MIL-STD-1472D, 5.4.1.4.5.4;  
DOE-STAND HFAC 1, 5.1.4.5.3
- 7.4.1.4.8 MIL-STD-1472D, 5.4.1.4.5.5;  
DOE-STAND HFAC 1, 5.1.4.5.4
- 7.4.1.5.1 MIL-STD-1472D, 5.4.1.6; DOE-  
STAND HFAC 1, 5.1.6.1
- 7.4.1.5.2 MIL-STD-1472D, 5.4.1.6; DOE-  
STAND HFAC 1, 5.1.6.1
- 7.4.1.5.3 MIL-STD-1472D, 5.4.1.7; DOE-  
STAND HFAC 1, 5.1.6.2
- 7.4.1.6.1 MIL-STD-1472D, 5.4.1.8.1;  
DOE-STAND HFAC 1, 5.1.7.1
- 7.4.1.6.2 MIL-STD-1472D, 5.4.1.8.2;  
DOE-STAND HFAC 1, 5.1.7.2
- 7.4.1.6.3 MIL-STD-1472D, 5.4.1.8.3;  
DOE-STAND HFAC 1, 5.1.7.3
- 7.4.1.6.4 MIL-STD-1472D, 5.4.1.8.4;  
DOE-STAND HFAC 1, 5.1.7.4
- 7.4.1.6.5 MIL-STD-1472D, 5.4.1.8.5;  
DOE-STAND HFAC 1, 5.1.7.5
- 7.4.2.1 MIL-STD-1472D, 5.4.1.8.6.1;  
DOE-STAND HFAC 1, 5.2.1.1
- 7.4.2.2 MIL-STD-1472D, 5.4.1.8.6.2;  
DOE-STAND HFAC 1, 5.2.1.2
- 7.4.2.3 MIL-STD-1472D, 5.4.1.8.6.3;  
DOE-STAND HFAC 1, 5.2.1.3
- 7.4.2.4 MIL-STD-1472D, 5.4.1.8.6.4;  
DOE-STAND HFAC 1, 7.4.2.4
- 7.4.3.1 MIL-STD-1472D, 5.4.3.1.2.3;  
DOE-STAND HFAC 1, 5.2.2.3
- 7.4.3.2 MIL-STD-1472D, 5.4.3.1.2.1;  
DOE-STAND HFAC 1, 5.2.2.1
- 7.4.3.3 MIL-STD-1472D, 5.4.3.1.2.2;  
DOE-STAND HFAC 1, 5.2.2.2
- 7.4.3.4 MIL-STD-1472D,; DOE-STAND  
HFAC 1, 5.2.2.2
- 7.4.3.5 MIL-STD-1472D, 5.4.3.1.2.4;  
DOE-STAND HFAC 1, 5.2.2.4
- 7.4.4.1.1 MIL-STD-1472D, 5.4.2.1.1.7;  
DOE-STAND HFAC 1, 5.3.1.7
- E7.4.4.1.1 Proposed MIL-STD-1472D,  
5.4.2.1.1.7; MIL-STD-1472D,  
5.4.2.1.1.7; MIL-STD-1800A,  
4.4.2.b
- 7.4.4.1.2 MIL-STD-1472D, 5.4.2.1.1.1;  
DOE-STAND HFAC 1, 5.3.1.1
- 7.4.4.1.3 MIL-STD-1472D, 5.4.2.1.1.2;  
DOE-STAND HFAC 1, 5.3.1.2
- 7.4.4.1.4 MIL-STD-1472D, 5.4.2.1.1.3;  
DOE-STAND HFAC 1, 5.3.1.3
- 7.4.4.1.5 MIL-STD-1472D, 5.4.2.1.1.4;  
DOE-STAND HFAC 1, 5.3.1.4
- 7.4.4.1.6 MIL-STD-1472D, 5.4.2.1.1.4;  
DOE-STAND HFAC 1, 5.3.1.4
- 7.4.4.1.7 MIL-STD-1472D, 5.4.2.1.1.4;  
DOE-STAND HFAC 1, 5.3.1.4
- 7.4.4.1.8 MIL-STD-1472D, 5.4.2.1.1.5;  
DOE-STAND HFAC 1, 5.3.1.5
- 7.4.4.1.9 MIL-STD-1472D, 5.4.2.1.1.6;  
DOE-STAND HFAC 1, 5.3.1.6
- 7.4.4.2.1 MIL-STD-1472D, 5.4.2.1.2.2;  
DOE-STAND HFAC 1, 5.3.2.2
- 7.4.4.2.2 MIL-STD-1472D, 5.4.2.1.2.3;  
DOE-STAND HFAC 1, 5.3.2.3
- 7.4.4.2.3 MIL-STD-1472D, 5.4.2.1.2.4;  
DOE-STAND HFAC 1, 5.3.2.4
- 7.4.4.2.4 MIL-STD-1472D, 5.4.2.1.2.5;  
DOE-STAND HFAC 1, 5.3.2.5
- 7.4.4.2.5 MIL-STD-1472D, 5.4.2.1.2.5;  
DOE-STAND HFAC 1, 5.3.2.5
- 7.4.4.2.6 MIL-STD-1472D, 5.4.2.1.2.5;  
DOE-STAND HFAC 1, 5.3.2.5
- 7.4.4.2.7 MIL-STD-1472D, 5.4.2.1.2.5;  
DOE-STAND HFAC 1, 5.3.2.5
- 7.4.4.2.8 MIL-STD-1472D, 5.4.2.1.2.5;  
DOE-STAND HFAC 1, 5.3.2.5
- 7.4.4.3.1 MIL-STD-1472D, 5.4.2.1.3.1;  
DOE-STAND HFAC 1, 5.3.3.1
- 7.4.4.3.2 MIL-STD-1472D, 5.4.2.1.3.2;  
DOE-STAND HFAC 1, 5.3.3.2
- 7.4.4.3.3 MIL-STD-1472D, 5.4.2.1.3.3;  
DOE-STAND HFAC 1, 5.3.3.3
- 7.4.4.3.4 MIL-STD-1472D, 5.4.2.1.3.4;  
DOE-STAND HFAC 1, 5.3.3.4
- 7.4.4.3.5 MIL-STD-1472D, 5.4.2.1.3.5.1;  
DOE-STAND HFAC 1, 5.3.3.5.1
- 7.4.4.3.6 MIL-STD-1472D, 5.4.2.1.3.5.2;  
DOE-STAND HFAC 1, 5.3.3.5.1
- 7.4.4.3.7 MIL-STD-1472D, 7.4.5.3.8;  
DOE-STAND HFAC 1, 5.3.3.7
- 7.4.4.3.8 MIL-STD-1472D, 5.4.2.1.3.7;  
DOE-STAND HFAC 1, 5.3.3.7
- E7.4.4.3.8 Proposed MIL-STD-1472D,  
5.4.2.1.3.9; MIL-STD-1472D,  
5.4.2.1.3.9; MIL-STD-1800A,  
4.4.2.d
- 7.4.4.3.9 MIL-STD-1472D, 5.4.2.1.3.8;  
DOE-STAND HFAC 1, 5.3.3.8

- 7.4.4.3.10** MIL-STD-1472D, 5.4.2.1.3.9; DOE-STAND HFAC 1, 5.3.3.9
- 7.4.4.4.1** MIL-STD-1472D, 5.4.2.1.2; DOE-STAND HFAC 1, 5.3.4.2
- E7.4.4.4.1** Proposed MIL-STD-1472D, 5.4.2.2.1.2; MIL-STD-1472D, 5.4.2.2.1.2; MIL-STD-1800A, 4.4.2.e
- 7.4.4.4.2** MIL-STD-1472D, 5.4.2.2.1.1; DOE-STAND HFAC 1, 5.3.4.1
- 7.4.4.4.3** NUREG-0700, 6.4.2.2; DOE-STAND HFAC 1, 5.3.4.3
- 7.4.4.5.1** MIL-STD-1472D, 5.4.2.2.2.2; DOE-STAND HFAC 1, 5.3.5.2
- E7.4.4.5.1** Proposed MIL-STD-1472D, 5.4.2.2.2.2; MIL-STD-1472D, 5.4.2.2.2.2; MIL-STD-1800A, 4.4.2.f
- 7.4.4.5.2** MIL-STD-1472D, 5.4.2.2.2.1; DOE-STAND HFAC 1, 5.3.5.1
- 7.4.4.5.3** MIL-STD-1472D, 5.4.2.2.2.3; DOE-STAND HFAC 1, 5.3.5.3
- 7.4.4.5.4** MIL-STD-1472D, 5.4.2.2.2.4; DOE-STAND HFAC 1, 5.3.5.4
- 7.4.4.5.5** MIL-STD-1472D, 5.4.2.2.2.5; DOE-STAND HFAC 1, 5.3.5.5
- E7.4.4.5.5** DOE-STAND HFAC 1, 5.3.5.5
- 7.4.4.5.6** MIL-STD-1472D, 5.4.2.2.2.6; DOE-STAND HFAC 1, 5.3.5.6
- 7.4.4.5.7** MIL-STD-1472D, 5.4.2.2.2.6; DOE-STAND HFAC 1, 5.3.5.6
- 7.4.4.6.1** MIL-STD-1472D, 5.4.2.2.3.4; DOE-STAND HFAC 1, 5.3.6.4
- E7.4.4.6.1** Proposed MIL-STD-1472D, 5.4.2.2.3.4; MIL-STD-1472D, 5.4.2.2.3.4; MIL-STD-1800A, 4.4.2.g
- 7.4.4.6.2** MIL-STD-1472D, 5.4.2.2.3.1; DOE-STAND HFAC 1, 5.3.6.1
- 7.4.4.6.3** MIL-STD-1472D, 5.4.2.2.3.2; DOE-STAND HFAC 1, 5.3.6.2
- 7.4.4.6.4** MIL-STD-1472D, 5.4.2.2.3.3; DOE-STAND HFAC 1, 5.3.6.3
- 7.4.4.6.5** MIL-STD-1472D, 5.4.2.2.3.6; DOE-STAND HFAC 1, 5.3.6.6
- 7.4.4.7.1** MIL-STD-1472D, 5.4.2.2.4.3; DOE-STAND HFAC 1, 5.3.7.5
- E7.4.4.7.1** Proposed MIL-STD-1472D, 5.4.2.2.4.3; MIL-STD-1472D, 5.4.2.2.4.3; MIL-STD-1800A, 4.4.2.i
- 7.4.4.7.2** MIL-STD-1472D, 5.4.2.2.4.1; DOE-STAND HFAC 1, 5.3.7.1
- 7.4.4.7.3** MIL-STD-1472D, 5.4.2.2.4.2; DOE-STAND HFAC 1, 5.3.7.2
- 7.4.4.7.4** MIL-STD-1472D, 5.4.2.2.4.4; DOE-STAND HFAC 1, 5.3.7.4
- 7.4.4.7.5** MIL-STD-1472D, 5.4.2.2.4.5; DOE-STAND HFAC 1, 5.3.7.5
- 7.4.4.8.1** MIL-STD-1472D, 5.4.3.1.1.5; DOE-STAND HFAC 1, 5.3.9.5
- E7.4.4.8.1** Proposed MIL-STD-1472D, 5.4.3.1.1.5; MIL-STD-1472D, 5.4.3.1.1.5; MIL-STD-1800A, 4.4.2.j
- 7.4.4.8.2** MIL-STD-1472D, 5.4.3.1.1.1; DOE-STAND HFAC 1, 5.3.9.1
- 7.4.4.8.3** MIL-STD-1472D, 5.4.3.1.1.1; DOE-STAND HFAC 1, 5.3.9.1
- 7.4.4.8.4** MIL-STD-1472D, 5.4.3.1.1.2; DOE-STAND HFAC 1, 5.3.9.2
- 7.4.4.8.5** MIL-STD-1472D, 5.4.3.1.1.4; DOE-STAND HFAC 1, 5.3.9.3
- 7.4.4.8.6** MIL-STD-1472D, 5.4.3.1.1.4; DOE-STAND HFAC 1, 5.3.9.4
- 7.4.4.9.1** MIL-STD-1472D, 5.4.3.1.3.1; DOE-STAND HFAC 1, 5.3.10.1
- 7.4.4.9.2** MIL-STD-1472D, 5.4.3.1.3.2; DOE-STAND HFAC 1, 5.3.10.2
- 7.4.4.9.3** MIL-STD-1472D, 5.4.3.1.3.2; DOE-STAND HFAC 1, 5.3.10.2
- 7.4.4.9.4** DOE-STAND HFAC 1, 5.3.10.2
- 7.4.4.9.5** DOE-STAND HFAC 1, 5.3.10.2
- 7.4.4.9.6** MIL-STD-1472D, 5.4.3.1.3.5; DOE-STAND HFAC 1, 5.3.10.3
- 7.4.4.9.7** MIL-STD-1472D, 5.4.3.1.3.6; DOE-STAND HFAC 1, 5.3.10.4
- 7.4.4.10.1** MIL-STD-1472D, 5.4.3.1.4.3; DOE-STAND HFAC 1, 5.3.11.3
- E7.4.4.10.1** Proposed MIL-STD-1472D, 5.4.3.1.4.3; MIL-STD-1472D, 5.4.3.1.4.3; MIL-STD-1800A, 4.4.2.l
- 7.4.4.10.2** MIL-STD-1472D, 5.4.3.1.4.1; DOE-STAND HFAC 1, 5.3.11.1
- 7.4.4.10.3** MIL-STD-1472D, 5.4.3.1.4.1; DOE-STAND HFAC 1, 5.3.11.1
- 7.4.4.10.4** MIL-STD-1472D, 5.4.3.1.4.2; DOE-STAND HFAC 1, 5.3.11.2
- 7.4.4.10.5** MIL-STD-1472D, 5.4.3.1.4.4; DOE-STAND HFAC 1, 5.3.11.4
- 7.4.4.10.6** MIL-STD-1472D, 5.4.3.1.4.5; DOE-STAND HFAC 1, 5.3.11.5
- 7.4.4.11.1** MIL-STD-1472D, 5.4.3.1.5.1; DOE-STAND HFAC 1, 5.3.12.1
- E7.4.4.11.1** Proposed MIL-STD-1472D, 5.4.3.1.5.1; MIL-STD-1472D, 5.4.3.1.5.1; MIL-STD-1800A, 4.3.24.2.5
- 7.4.4.11.2** MIL-STD-1472D, 5.4.3.1.5.2; DOE-STAND HFAC 1, 5.3.12.2
- 7.4.4.11.3** MIL-STD-1472D, 5.4.3.1.5.3; DOE-STAND HFAC 1, 5.3.12.3
- 7.4.4.11.4** MIL-STD-1472D, 5.4.3.1.5.3; DOE-STAND HFAC 1, 5.3.12.3
- 7.4.4.11.5** MIL-STD-1472D, 5.4.3.1.5.3; DOE-STAND HFAC 1, 5.3.12.3
- 7.4.4.11.6** MIL-STD-1472D, 5.4.3.1.5.3; DOE-STAND HFAC 1, 5.3.12.3
- 7.4.4.11.7** MIL-STD-1472D, 5.4.3.1.5.3; DOE-STAND HFAC 1, 5.3.12.3
- 7.4.4.12.1** MIL-STD-1472D, 5.4.3.1.6.4; DOE-STAND HFAC 1, 5.3.13.4
- E7.4.4.12.1** Proposed MIL-STD-1472D, 5.4.3.1.6.4; MIL-STD-1472D, 5.4.3.1.6.4; MIL-STD-1800A, 4.4.2.m
- 7.4.4.12.2** MIL-STD-1472D, 5.4.3.1.6.1; DOE-STAND HFAC 1, 5.3.13.1
- 7.4.4.12.3** MIL-STD-1472D, 5.4.3.1.6.1; DOE-STAND HFAC 1, 5.3.13.1
- 7.4.4.12.4** MIL-STD-1472D, 5.4.3.1.6.2; DOE-STAND HFAC 1, 5.3.13.2

- 7.4.4.12.5** MIL-STD-1472D, 5.4.3.1.6.3;  
DOE-STAND HFAC 1, 5.3.13.3
- 7.4.4.12.6** MIL-STD-1472D, 5.4.3.1.6.6;  
DOE-STAND HFAC 1, 5.3.13.5
- 7.4.4.12.8** MIL-STD-1472D, 5.4.3.1.6.7;  
DOE-STAND HFAC 1, 5.3.13.6
- 7.4.4.13.1** MIL-STD-1472D, 5.4.3.1.7.3;  
DOE-STAND HFAC 1, 5.3.14.3
- E7.4.4.13.1** Proposed MIL-STD-1472D,  
5.4.3.1.7.3; MIL-STD-1472D,  
5.4.3.1.7.3; MIL-STD-1800A,  
4.4.2.n
- 7.4.4.13.2** MIL-STD-1472D, 5.4.3.1.7.2;  
DOE-STAND HFAC 1, 5.3.14.2
- 7.4.4.13.3** MIL-STD-1472D, 5.4.3.1.7.4;  
DOE-STAND HFAC 1, 5.1.14.4
- 7.4.4.13.4** MIL-STD-1472D, 5.4.3.1.7.5;  
DOE-STAND HFAC 1, 5.3.14.5
- 7.4.4.14.1** MIL-STD-1472D, 5.4.3.1.8.2;  
DOE-STAND HFAC 1, 5.3.15.2
- E7.4.4.14.1** Proposed MIL-STD-1472D,  
5.4.3.1.8.2; MIL-STD-1472D,  
5.4.3.1.8.2; MIL-STD-1800A,  
4.4.2.o
- 7.4.4.14.2** MIL-STD-1472D, 5.4.3.1.8.1;  
DOE-STAND HFAC 1, 5.3.15.1
- 7.4.4.14.3** MIL-STD-1472D, 5.4.3.1.8.3;  
DOE-STAND HFAC 1, 5.3.15.3
- 7.4.4.14.4** MIL-STD-1472D, 5.4.3.1.8.4;  
DOE-STAND HFAC 1, 5.3.15.4
- 7.4.4.14.5** MIL-STD-1472D, 5.4.3.1.8.5;  
DOE-STAND HFAC 1, 5.3.15.5
- 7.4.4.14.6** MIL-STD-1472D, 5.4.3.1.8.6;  
DOE-STAND HFAC 1, 5.3.15.6
- 7.4.4.14.7** MIL-STD-1472D, 5.4.3.1.8.7;  
DOE-STAND HFAC 1, 5.3.15.7
- 7.4.4.15** MIL-STD-1472D, 5.4.3.1.9.1;  
DOE-STAND HFAC 1, 5.3.16.1
- 7.4.4.15.1** MIL-STD-1472D, 5.4.3.1.9.2;  
DOE-STAND HFAC 1, 5.3.16.2
- 7.4.4.15.2** MIL-STD-1472D, 5.4.3.1.9.2;  
DOE-STAND HFAC 1, 5.3.16.2
- 7.4.4.15.3** MIL-STD-1472D, 5.4.3.1.9.2;  
DOE-STAND HFAC 1, 5.3.16.2
- 7.4.4.15.4** MIL-STD-1472D, 5.4.3.1.9.2;  
DOE-STAND HFAC 1, 5.3.16.2
- 7.4.4.15.5** MIL-STD-1472D, 5.4.3.1.9.3;  
DOE-STAND HFAC 1, 5.3.16.3
- 7.4.4.16.1** MIL-STD-1472D, 5.4.3.2.1.5;  
DOE-STAND HFAC 1, 5.3.17.5
- E7.4.4.16.1** Proposed MIL-STD-1472D,  
5.4.3.2.1.8; MIL-STD-1472D,  
5.4.3.2.1.8; MIL-STD-1800A,  
4.4.2.p
- 7.4.4.16.2** MIL-STD-1472D, 5.4.3.2.1.1;  
DOE-STAND HFAC 1, 5.3.17.1
- 7.4.4.16.3** MIL-STD-1472D, 5.4.3.2.1.2;  
DOE-STAND HFAC 1, 5.3.17.2
- 7.4.4.16.4** MIL-STD-1472D, 5.4.3.2.1.3;  
DOE-STAND HFAC 1, 5.3.17.3
- 7.4.4.16.5** MIL-STD-1472D, 5.4.3.2.1.4;  
DOE-STAND HFAC 1, 5.3.17.4
- 7.4.4.17.1** MIL-STD-1472D, 5.4.3.2.1.3
- 7.4.4.17.2** MIL-STD-1472D, 5.4.3.2.1.2
- 7.4.4.17.3** MIL-STD-1472D, 5.4.3.2.1.1,  
5.4.3.2.2
- 7.4.4.18.1** MIL-STD-1472D, 5.4.3.2.2.3
- E7.4.4.18.1** MIL-STD-1472D, 5.4.3.2.3.2.3;  
DOE-STAND HFAC 1,  
5.3.18.3.3; MIL-STD-1800A,  
4.4.2.q
- 7.4.4.18.2** MIL-STD-1472D, 5.4.3.2.2.2.3
- 7.4.4.18.3** MIL-STD-1472D, 5.4.3.2.2.2.2
- 7.4.4.19.1** MIL-STD-1472D, 5.4.3.2.2.3.3
- 7.4.4.19.3** MIL-STD-1472D, 5.4.3.2.2.3.3
- 7.4.4.20** MIL-STD-1472D, 5.4.3.2.3,  
5.4.3.2.3.1.1,
- 7.4.4.20.1** MIL-STD-1472D, 5.4.3.2.3.1.2,  
5.4.3.2.3.1.3
- 7.4.4.20.1** MIL-STD-1472D, 5.4.3.2.3.1.3
- 7.4.4.21.1** MIL-STD-1472D, 5.4.3.2.3.3.1,  
5.4.3.2.3.3.3
- 7.4.4.22.1** MIL-STD-1472D, 5.4.3.2.4.4
- E7.4.4.22.1** MIL-STD-1472D, 5.4.3.2.4.4;  
DOE-STAND HFAC 1, 5.3.20.4;  
MIL-STD-1800A, 4.4.2.s
- 7.4.4.22.2** MIL-STD-1472D, 5.4.3.2.4.3
- 7.4.4.22.3** MIL-STD-1472D, 5.4.3.2.4.2
- 7.4.4.22.4** MIL-STD-1472D, 5.4.3.2.4.1
- 7.4.4.22.5** MIL-STD-1472D, 5.4.3.2.4.1
- 7.4.4.23.1** MIL-STD-1472D, 5.4.3.2.5.3
- 7.4.4.23.2** MIL-STD-1472D, 5.4.3.2.5.2
- 7.4.4.23.3** MIL-STD-1472D, 5.4.3.2.5.1
- 7.4.4.24.1** MIL-STD-1472D, 5.4.4.2
- E7.4.4.24.1** MIL-HDBK-759B, 5.3.4.1; MIL-  
STD-1472D, 5.4.4.2; MIL-STD-  
1800A, 4.2.3; AFSC DH 1-3, DN  
2B11, 5.f
- 7.4.4.25.1** MIL-STD-1472D, 5.4.5.2
- 7.4.4.25.2** MIL-STD-1472D, 5.4.5.2
- 7.4.4.25.3** MIL-STD-1472D, 5.4.5.1
- 7.4.4.25.4** MIL-STD-1472D, 5.4.5.3
- 7.5.1** MIL-STD-1472D, 5.5.1.2; MIL-  
HDBK-759B, 5.5.1.1.2, DOE-  
STAND HFAC 1, 6.1.2
- 7.5.1.1** MIL-STD-1472D, 5.5.1.1; MIL-  
HDBK-759B, 5.5.1.1.1, DOE-  
STAND HFAC 1, 6.1.1
- 7.5.1.2** MIL-STD-1472D, 5.5.6.2.5;  
DOE-STAND HFAC 1, 6.6.4.6
- 7.5.1.3** EPRI NP 6209 Sect 3 ; DOE-  
STAND HFAC 1, 6.6.4.6.1
- 7.5.1.4** MIL-STD-1472D, 5.5.6.2.1; MIL-  
HDBK-759B, 5.5.1.7.1, DOE-  
STAND HFAC 1, 6.6.4.1
- 7.5.1.5** MIL-HDBK-759B, 5.5.1.1.2,
- 7.5.1.6** MIL-STD-1472D, 5.5.6.2.3; MIL-  
HDBK-759B, 5.5.1.7.3.a, DOE-  
STAND HFAC 1, 6.6.4.3
- 7.5.1.7** MIL-STD-1472D, 5.5.6.2.3.b;  
MIL-HDBK-759B, 5.5.1.7.3,  
DOE-STAND HFAC 1, 6.6.4.3
- 7.5.1.8** MIL-STD-1472D, 5.5.6.2.3.c;  
MIL-HDBK-759B, 5.5.1.7.3,  
DOE-STAND HFAC 1, 6.6.4.3
- 7.5.1.9** MIL-STD-1472D, 5.5.6.2.3.d;  
MIL-HDBK-759B, 5.5.1.7.3,  
DOE-STAND HFAC 1, 6.6.4.3
- 7.5.1.10** EPRI NP 6209 Sect 3; DOE-  
STAND HFAC 1, 6.2.4
- 7.5.1.11** EPRI NP 6209 Sect 3; DOE-  
STAND HFAC 1, 6.2.4

- 7.5.1.12 MIL-STD-1472D, 5.5.2.1; DOE-STAND HFAC 1, 6.2.1; NUREG-0700, 6.6.2.3
- 7.5.1.13 EPRI NP 6209, Sect 3; DOE-STAND HFAC 1, 6.4.8
- 7.5.1.15 EPRI NP 6209 Sect 3; DOE-STAND HFAC 1, 6.2.4.1
- 7.5.2.1 EPRI NP 6209 Sect 3; MIL-STD-1472D, 5.5.2.2; MIL-HDBK-759B, 5.5.1.2.2; UCRL-15673, 1.3.4.2.c
- 7.5.2.2 EPRI NP 6209 Sect 3; MIL-STD-1472D, 5.5.2.2; MIL-HDBK-759B, 5.5.1.2.2;
- 7.5.2.3 EPRI NP 6209 Sect 3; MIL-STD-1472D, 5.5.2.2; MIL-HDBK-759B, 5.5.1.2.2;
- 7.5.2.4 NUREG-0700, 6.6.2.1.c
- 7.5.2.5 NUREG-0700, 6.6.2.1.c
- 7.5.2.6 NUREG-0700, 6.6.2.1.c; EPRI NP 6209 Sect 3
- 7.5.2.7 MIL-STD-1472D, 5.5.2.3; MIL-HDBK-759B, 5.5.1.2.3; DOE-STAND HFAC 1, 6.2.3
- 7.5.2.8 NUREG-0700, 6.6.1.2; DOE-STAND HFAC 1, 6.6.4.5
- 7.5.2.9 NUREG-0700, 6.6.2.3; DOE-STAND HFAC 1, 6.2.1; MIL-STD-1472D, 5.5.2.1
- 7.5.2.10 NUREG-0700, 6.6.2.2; DOE-STAND HFAC 1, 6.4.6; MIL-STD-1472D, 5.5.4.5
- 7.5.3.1 UCRL-15673, 1.3.4.3.c
- 7.5.3.2 MIL-STD-1472D, 5.5.5.8; MIL-HDBK-759B, 5.5.1.5.1.3; DOE-STAND HFAC 1, 6.5.7.1
- 7.5.3.3 MIL-STD-1472D, 5.5.5.9; EPRI NP 6209, 5.5.1.5.1.3; DOE-STAND HFAC 1, 6.5.7.2
- 7.5.3.4 MIL-STD-1472D, 5.5.5.10; DOE-STAND HFAC 1, 6.5.7.3
- 7.5.3.5 MIL-STD-1472D, 5.5.5.5; EPRI NP 6209 Sect 3; MIL-HDBK-759B, 5.5.1.5.1.2; DOE-STAND HFAC 1, 6.5.5
- 7.5.3.6 MIL-STD-1472D, 5.5.5.11; MIL-HDBK-759B, 5.5.1.5.2; DOE-STAND HFAC 1, 6.5.8
- 7.5.3.7 MIL-STD-1472D, 5.5.5.12; MIL-HDBK-759B, 5.5.1.5.3; DOE-STAND HFAC 1, 6.5.10
- 7.5.3.8 MIL-STD-1472D, 5.5.5.13; MIL-HDBK-759B, 5.5.1.5.5; DOE-STAND HFAC 1, 6.5.10
- 7.5.3.9 UCRL-15673, 1.3.4.3.c.3
- 7.5.4.1 MIL-STD-1472D, 5.5.5.1; EPRI NP 6209, Sect 3; DOE-STAND HFAC 1, 6.5.1
- 7.5.4.2 MIL-STD-1472D, 5.5.5.2; EPRI NP 6209, Sect 3; DOE-STAND HFAC 1, 6.5.2
- 7.5.4.3 NUREG-0700, 6.6.4.2; EPRI NP 6209, Sect 3; DOE-STAND HFAC 1, 6.5.1
- 7.5.4.4 MIL-HDBK-759B, 5.5.1.5.4
- 7.5.4.5 MIL-HDBK-759B, 5.5.1.5.8
- 7.5.5.1 MIL-STD-1472D, 5.5.4.1; MIL-HDBK-759B, 5.5.1.4.1; DOE-STAND HFAC 1, 6.4.1
- 7.5.5.2 MIL-STD-1472D, 5.5.6.2.2; MIL-HDBK-759B, 5.5.1.7.2; DOE-STAND HFAC 1, 6.4.1
- 7.5.5.3 UCRL-15673, 1.3.4.3.d.3
- 7.5.5.4 MIL-STD-1472D, 5.5.3.3; DOE-STAND HFAC 1, 6.3.5
- 7.5.5.5 MIL-STD-1472D, 5.5.3.3; DOE-STAND HFAC 1, 6.3.5
- 7.5.5.6 MIL-HDBK-759B, 5.5.1.5.7; Public Law 101-336, 7/26/1990 Section 101; Vanderkerden & Vanderkerden 1991, 1-2; Vanderkerden & Vanderkerden 1991, 16-17; Vanderkerden & Vanderkerden 1990, 383-396
- 7.6.1.1 Vanderkerden & Vanderkerden 1991, M-1, 66-69
- 7.6.1.2 Vanderkerden & Vanderkerden 1991, M-2, 70
- 7.6.1.3 Vanderkerden & Vanderkerden 1991, M-3, 71
- 7.6.1.4 Vanderkerden & Vanderkerden 1991, M-4, 72-73
- 7.6.2.1 Vanderkerden & Vanderkerden 1991, O-1, 20-21
- 7.6.2.2 Vanderkerden & Vanderkerden 1991, O-2, 24
- 7.6.2.3 Vanderkerden & Vanderkerden 1991, O-3, 27
- 7.6.2.4 Vanderkerden & Vanderkerden 1991, O-3, 27
- 7.6.2.5 Vanderkerden & Vanderkerden 1991, O-4, 28-29
- 7.6.2.6 Vanderkerden & Vanderkerden 1991, O-5, 31-33
- 7.6.2.7 Vanderkerden & Vanderkerden 1991, O-6, 34-35
- 7.6.2.8 Vanderkerden & Vanderkerden 1991, O-7, 36
- 7.6.3.1 Vanderkerden & Vanderkerden 1991, I-5, 50-53
- 7.6.3.2 Kanis 1988, 418
- E7.6.3.2 Kanis 1988, 416-419
- 7.6.3.3 Kanis 1993, 326
- 7.6.3.4 Kanis 1993, 327
- 7.6.3.5 Kanis 1993, 327
- 7.6.3.6 Kanis 1993, 327
- 7.6.3.7 Kanis 1993, 327
- 7.6.3.8 Vanderherden & Vanderherden 1991, I-7, 59-61
- 7.6.3.9 Vanderherden & Vanderherden 1991, I-1, 38-40
- 7.6.3.12 Vanderherden & Vanderherden 1991, I-6, 54-58
- 7.6.3.13 Vanderherden & Vanderherden 1991, I-4, 47-49
- 7.6.4 Benel 1988, 271
- 7.6.5 Vanderherden & Vanderherden 1991, S-2, 81
- 7.6.5.5 Vanderherden & Vanderherden 1991, S-1 80
- 8 SMEs 11, 12, 13, 14, 15, 16, 17, 24, 28, 29, 30, 31, 32,

- 8.1** DOE HFDG ATCCS, V2.0, 2.0
- 8.1.1.1** DOE HFDG ATCCS, V2.0, 2.1.13.1; MIL-HDBK-761A, 5.1.1.3.c
- 8.1.1.2** DOE HFDG ATCCS, V2.0, 2.1.11
- 8.1.1.3** DOE HFDG ATCCS, V2.0, 2.0; MIL-HDBK-761A, 5.1.1.a
- 8.1.1.4** DOE HFDG ATCCS, V2.0, 2.1.6; MIL-HDBK-761A, 5.1.1.b
- 8.1.1.5** DOE HFDG ATCCS, V2.0, 2.1.14.1;
- 8.1.1.6** MIL-HDBK-761A, 5.1.1.3.a
- 8.1.1.7** DOE HFDG ATCCS, V2.0, 2.1.14.2;
- 8.1.1.8** DOE HFDG ATCCS, V2.0, 2.1.8;
- 8.1.1.9** DOE HFDG ATCCS, V2.0, 2.1.7
- 8.1.1.10** MIL-HDBK-761A, 5.1.1.7.c
- 8.1.1.11** DOE HFDG ATCCS, V2.0, 2.1.13.2; MIL-HDBK-761A, 5.1.1.3.b
- 8.1.1.12** DOE HFDG ATCCS, V2.0, 2.0
- 8.1.1.13** DOE HFDG ATCCS, V2.0, 2.1.9
- 8.1.1.14** MIL-HDBK-761A, 5.1.1.c
- 8.1.1.15** DOE HFDG ATCCS, V2.0, 2.1.3 and Appendix B
- 8.1.1.16** DOE HFDG ATCCS, V2.0, 2.1.4; MIL-HDBK-761A, 5.1.1.7.d
- 8.1.1.17** DOE HFDG ATCCS, V2.0, 2.0
- 8.1.1.18** DOE HFDG ATCCS, V2.0, 2.1.13.3; MIL-HDBK-761A, 5.1.1.7.b
- 8.1.1.19** DOE HFDG ATCCS, V2.0, 2.0.
- 8.1.1.20** DON UISNCCS, V1.2, 3.6.1
- 8.1.1.21** DON UISNCCS, V1.2, 3.6.2
- 8.1.1.22** DON UISNCCS, V1.2, 3.6.3
- 8.1.1.23** DON UISNCCS, V1.2, 3.6.3
- 8.1.1.24** DON UISNCCS, V1.2, 3.6.3
- 8.1.1.25** DON UISNCCS, V1.2, 3.6.3
- 8.1.1.26** DON UISNCCS, V1.2, 3.6.5
- 8.1.1.27** DON UISNCCS, V1.2, 3.6.6
- 8.1.2.1** DOE HFDG ATCCS, V2.0, 2.1.17.1, 2.1.17.2; MIL-HDBK-761A, 5.1.1.12.a
- 8.1.2.2** DOE HFDG ATCCS, V2.0, 2.1.14.4; MIL-HDBK-761A, 5.1.1.12.b
- 8.1.2.3** MIL-HDBK-761A, 5.1.1.12.f
- 8.1.2.4** MIL-HDBK-761A, 5.1.1.12.d
- 8.1.2.5** MIL-HDBK-761A, 5.1.1.12.e
- 8.1.2.6** DOE HFDG ATCCS, V2.0, 2.1.16.1
- 8.1.2.7** MIL-HDBK-761A, 5.1.1.12.c
- 8.1.2.8** DOE HFDG ATCCS, V2.0, 2.1.16.2
- 8.1.2.9** DOE HFDG ATCCS, V2.0, 2.1.16.3
- 8.1.3.1.1** MIL-HDBK-761A, 5.1.1.8.a
- 8.1.3.1.2** MIL-HDBK-761A, 5.1.1.8.b, 5.1.4.e
- 8.1.3.1.3** MIL-HDBK-761A, 5.1.1.8.e
- 8.1.3.1.4** DOE HFDG ATCCS, V2.0, 2.1.12
- 8.1.3.1.5** MIL-HDBK-761A, 5.1.1.8.d
- 8.1.3.2.1** DOE HFDG ATCCS, V2.0, 2.0, 2.1.15.2; MIL-HDBK-761A, 5.1.1.10.a
- 8.1.3.2.2** DOE HFDG ATCCS, V2.0, 2.0, 2.1.15.1; MIL-HDBK-761A, 5.1.1.10.c
- 8.1.3.2.3** MIL-HDBK-761A, 5.1.1.10.d
- 8.1.3.2.4** DOE HFDG ATCCS, V2.0, 2.0, 2.1.15.3; MIL-HDBK-761A, 5.1.1.10.b
- 8.1.3.3.1** DOE HFDG ATCCS, V2.0, 2.4.9
- 8.1.3.3.2** DOE HFDG ATCCS, V2.0, 2.4.6
- 8.1.3.4.1** MIL-HDBK-761A, 5.4.2.2.1.a, 5.4.2.2.1.d; MIL-STD-1801, 4.6.2.1, 4.6.2.2, 4.6.2.3
- 8.1.3.4.2** MIL-HDBK-761A, 5.4.2.2.1.b
- 8.1.3.4.3** MIL-HDBK-761A, 5.4.2.2.1.c
- 8.1.3.5.1** DOE HFDG ATCCS, V2.0, 2.6.3; MIL-HDBK-761A, 5.1.1.11.b; MIL-STD-1801, 4.2.5.1
- 8.1.3.5.2** MIL-STD-1801, 4.2.5.2
- 8.1.3.5.3** MIL-STD-1801, 4.2.5.2
- 8.1.3.5.4** DOE HFDG ATCCS, V2.0, 2.6.1; MIL-HDBK-761A, 5.1.1.11.d
- 8.1.3.5.5** DOE HFDG ATCCS, V2.0, 2.6.2; MIL-HDBK-761A, 5.1.1.11.c; MIL-STD-1801, 4.2.5.3
- 8.1.3.5.6** DOE HFDG ATCCS, V2.0, 2.6.4; MIL-HDBK-761A, 5.1.1.11.a
- 8.1.3.6.1** MIL-STD-1801, 4.6.3.1
- 8.1.3.6.2** DOE HFDG ATCCS, V2.0, 14.13.6, DOD HCISG V2.0, 8.2.13.6
- 8.1.3.6.3** DOE HFDG ATCCS, V2.0, 14.13.5, DOD HCISG V2.0, 8.2.13.5
- 8.1.4.1** DOE HFDG ATCCS, V2.0, 2.4.5, 2.4.10; MIL-HDBK-761A, 5.1.1.4.3.d, 5.1.9; MIL-STD-1801, 4.2.3.1
- 8.1.4.2** MIL-HDBK-761A, 5.1.9.b;
- 8.1.4.3** DOE HFDG ATCCS, V2.0, 2.4.11; MIL-HDBK-761A, 5.1.9.c.2; MIL-STD-1801, 4.2.3.1.b
- 8.1.4.4** DOE HFDG ATCCS, V2.0, 2.4.9; MIL-HDBK-761A, 5.1.9.c.1; MIL-STD-1801, 4.2.3.1.a
- 8.1.4.5** DOE HFDG ATCCS, V2.0, 2.4.4; MIL-HDBK-761A, 5.1.9.c.5; MIL-STD-1801, 4.2.3.1.e
- 8.1.4.6** DOE HFDG ATCCS, V2.0, 2.4.2; MIL-HDBK-761A, 5.1.9.c.6; MIL-STD-1801, 4.2.3.1.f
- 8.1.4.7** DOE HFDG ATCCS, V2.0, 2.4.3; MIL-HDBK-761A, 5.1.9.c.6
- 8.1.4.8** DOE HFDG ATCCS, V2.0, 2.4.12; MIL-HDBK-761A, 5.1.9.c.4; MIL-STD-1801, 4.2.3.1.c

- 8.1.4.9** DOE HFDG ATCCS, V2.0, 2.4.1; MIL-HDBK-761A, 5.1.9.c.3;
- 8.1.4.10** DOE HFDG ATCCS, V2.0, 2.4.7.1; MIL-HDBK-761A, 5.1.9.c.7; MIL-STD-1801, 4.2.3.1.g
- 8.1.4.11** DOE HFDG ATCCS, V2.0, 2.4.7.2; MIL-HDBK-761A, 5.1.9.c.7
- 8.1.5.1.1** MIL-HDBK-761A, 5.1.10.a
- 8.1.5.1.2** MIL-HDBK-761A, 5.1.10.b; DOE HFDG ATCCS, V2.0, 2.5.11
- 8.1.5.1.3** MIL-HDBK-761A, 5.1.10.c
- 8.1.5.1.4** DOE HFDG ATCCS, V2.0, 2.5.10
- 8.1.5.1.5** DOE HFDG ATCCS, V2.0, 2.5.8
- 8.1.5.1.6** DOE HFDG ATCCS, V2.0, 2.5.7
- 8.1.5.1.7** DOE HFDG ATCCS, V2.0, 2.5.13
- 8.1.5.1.8** MIL-HDBK-761A, 5.1.10.3.b; DOE HFDG ATCCS, V2.0, 2.5.6; MIL-STD-1801, 4.2.4.4
- 8.1.5.1.9** MIL-HDBK-761A, 5.1.10.3.c
- 8.1.5.1.10** DOE HFDG ATCCS, V2.0, 2.5.1, 2.5.2, 2.5.9; MIL-STD-1801, 4.2.4.5, 4.2.4.6
- 8.1.5.1.11** DOE HFDG ATCCS, V2.0, 2.5.5
- 8.1.5.1.12** DOE HFDG ATCCS, V2.0, 2.5.10; MIL-STD-1801, 4.2.4.7
- 8.1.5.1.13** DOE HFDG ATCCS, V2.0, 2.5.10; MIL-STD-1801, 4.2.4.7
- 8.1.5.2.1** DOE HFDG ATCCS, V2.0, 14.13; DOD HCISG V2.0, 8.2.1.2, 8.2.13
- 8.1.5.2.2** DOE HFDG ATCCS, V2.0, 14.13.3; DOD HCISG V2.0, 8.2.13.3; MIL-STD-1801, 4.6.4.7
- 8.1.5.2.3** MIL-STD-1801, 4.6.4.2
- 8.1.5.2.4** MIL-STD-1801, 4.6.4.3
- 8.1.5.2.5** MIL-STD-1801, 4.6.4.4
- 8.1.5.2.6** MIL-STD-1801, 4.6.4.3
- 8.1.5.2.7** DOE HFDG ATCCS, V2.0, 14.13.4; DOD HCISG V2.0, 8.2.13.4
- 8.1.5.2.8** MIL-STD-1801, 4.6.4.1
- 8.1.5.2.9** DOE HFDG ATCCS, V2.0, 14.13.2; DOD HCISG V2.0, 8.2.13.2
- 8.1.5.2.10** MIL-STD-1801, 4.6.4.6
- 8.1.5.2.11** MIL-STD-1801, 4.6.4.5
- 8.1.5.2.12** New
- 8.1.5.3.1** MIL-HDBK-761A, 5.1.10.a; MIL-STD-1801,
- 8.1.5.3.2** MIL-HDBK-761A, 5.1.10.3.a; MIL-STD-1801, 4.2.4.2
- 8.1.5.3.3** MIL-HDBK-761A, 5.1.10.1.c
- 8.1.5.3.4** MIL-HDBK-761A, 5.1.10.1.b; DOE HFDG ATCCS, V2.0, 2.5.3
- 8.1.5.3.5** DOE HFDG ATCCS, V2.0, 2.5.4
- 8.1.5.3.6** MIL-HDBK-761A, 5.1.10.1.a; MIL-STD-1801, 4.2.4.3
- 8.1.6.1** DOE HFDG ATCCS, V2.0, 2.3.3; MIL-HDBK-761A, 5.1.1.4.1; MIL-STD-1801, 4.2.2.4
- 8.1.6.2** MIL-HDBK-761A, 5.1.1.4.3.e
- 8.1.6.3** DOE HFDG ATCCS, V2.0, 2.3.8; MIL-HDBK-761A, 5.1.1.4.2.f
- 8.1.6.4** DOE HFDG ATCCS, V2.0, 2.3.9; MIL-HDBK-761A, 5.1.1.4.2.a
- 8.1.6.5** MIL-HDBK-761A, 5.1.1.4.2.c
- 8.1.6.6** MIL-HDBK-761A, 5.1.1.4.3.a
- 8.1.6.7** MIL-HDBK-761A, 5.1.1.4.2.b
- 8.1.6.8** DOE HFDG ATCCS, V2.0, 2.5.8;
- 8.1.6.9** DOE HFDG ATCCS, V2.0, 2.3.2; MIL-HDBK-761A, 5.1.1.4.3.b
- 8.1.6.10** DOE HFDG ATCCS, V2.0, 2.3.7.2;
- 8.1.6.11** DOE HFDG ATCCS, V2.0, 2.3.7.1;
- 8.1.6.12** DOE HFDG ATCCS, V2.0, 2.3.1; MIL-HDBK-761A, 5.1.1.4.3.c
- 8.1.6.13** MIL-HDBK-761A, 5.1.1.4.2.e
- 8.1.6.14** DOE HFDG ATCCS, V2.0, 2.3.6, 2.3.6.3, 2.1.14.3; MIL-HDBK-761A, 5.1.1.4.4.b; MIL-STD-1801, 4.2.2.2
- 8.1.6.15** MIL-HDBK-761A, 5.1.1.4.4.c; MIL-STD-1801, 4.2.2.2
- 8.1.6.16** DOE HFDG ATCCS, V2.0, 2.3.6.2; MIL-HDBK-761A, 5.1.1.4.4.a; MIL-STD-1801, 4.2.2.3
- 8.1.7.1** MIL-HDBK-761A, 5.1.1.6.e; MIL-STD-12D, 3.1
- 8.1.7.2** MIL-HDBK-761A, 5.1.1.6.a
- 8.1.7.3** DOE HFDG ATCCS, V2.0, 2.1.5; MIL-HDBK-761A, 5.1.1.6.d
- 8.1.7.4** MIL-HDBK-761A, 6.1.1.6.b
- 8.1.8.1** MIL-HDBK-761A, 5.1.1.13
- h.** ESD-TR-86-278, 3.1.8.5
- 8.1.8.2** DOE HFDG ATCCS, V2.0, 2.1.10
- 8.1.8.3** MIL-HDBK-761A, 5.1.1.3.d, 5.1.1.3.e
- 8.1.9.1** MIL-HDBK-761A, 5.1.2.a; MIL-STD-1801, 4.2.1.2.a
- 8.1.9.2** MIL-HDBK-761A, 5.1.2.a; MIL-STD-1801, 4.2.1.2.b
- 8.1.9.3** MIL-HDBK-761A, 5.1.2.c; MIL-STD-1801, 4.2.1.2.c
- 8.1.10.1** MIL-HDBK-761A, 5.1.3.b
- 8.1.10.2** MIL-HDBK-761A, 5.1.3.a
- 8.1.10.3** New
- 8.1.10.4** MIL-HDBK-761A, 5.1.3.
- 8.1.11** DOE HFDG ATCCS, V2.0, 5.0; DOD HCISG V2.0, 6.0
- 8.1.11.1.1** MIL-HDBK-761A, 5.1.4.2.a;
- 8.1.11.1.2** DOE HFDG ATCCS, V2.0, 6.0;
- 8.1.11.1.3** MIL-HDBK-761A, 5.1.4.1.e;
- 8.1.11.1.4** MIL-HDBK-761A, 5.1.4.2.c; MIL-STD-1801, 4.2.1.3.i
- 8.1.11.1.5** DOE HFDG ATCCS, V2.0, 6.1.1; DOD HCISG V2.0, 6.1.1
- 8.1.11.1.6** MIL-HDBK-761A, 5.1.4.4.b;
- 8.1.11.1.7** MIL-HDBK-761A, 5.1.4.b; MIL-STD-1801, 4.1.1.3.1



- 8.1.11.1.8** MIL-HDBK-761A, 5.1.4.c, 5.1.4.d;
- 8.1.11.1.9** MIL-HDBK-761A, 5.1.4.4.i; DOE HFDG ATCCS, V2.0, 5.3.3.5; DOD HCISG V2.0, 6.3.3.5; MIL-STD-1801, 4.2.1.3.s
- 8.1.11.1.10** DOE HFDG ATCCS, V2.0, DOD HCISG V2.0, 6.1.2
- 8.1.11.1.11** DOE HFDG ATCCS, V2.0, 5.0; DoD HCISG V2 6.0
- 8.1.11.1.12** DOE HFDG ATCCS, V2.0, DoD HCISG V2 6.1.4
- 8.1.11.1.13** MIL-HDBK-761A, 5.1.4.1.g; DOE HFDG ATCCS, V2.0, 5.1.5; MIL-STD-1801, 4.2.1.3.m; DoD HCISG V2 6.1.5
- 8.1.11.2.1** DOE HFDG ATCCS, V2.0, 5.2.1.9; DoD HCISG V2 6.2.1.1, 6.2.1.9; MIL-HDBK-761A, 5.1.4.1.b; MIL-STD-1801, 4.2.1.3.b
- 8.1.11.2.2** DOE HFDG ATCCS, V2.0, 5.2.1.2; DoD HCISG V2 6.2.1.2
- 8.1.11.2.3** DOE HFDG ATCCS, V2.0, 5.2.1.3; DoD HCISG V2 6.2.1.3; MIL-HDBK-761A, 5.1.4.1.a; MIL-STD-1801, 4.2.1.3.o
- 8.1.11.2.4** DOE HFDG ATCCS, V2.0, 5.2.1.4; DoD HCISG V2 6.2.1.4;
- 8.1.11.2.5** DOE HFDG ATCCS, V2.0, 5.2.1.5, 5.2.1.6; DoD HCISG V2 6.2.1.5, 6.2.1.6; MIL-HDBK-761A, 5.1.4.1.c, 5.1.4.1.d; MIL-STD-1801, 4.2.1.3.n
- 8.1.11.2.6** DOE HFDG ATCCS, V2.0, 5.2.1.7; DoD HCISG V2 6.2.1.7;
- 8.1.11.2.7** DOE HFDG ATCCS, V2.0, 5.2.1.8; DoD HCISG V2 6.2.1.8
- 8.1.11.3.1** DOE HFDG ATCCS, V2.0, 5.3.1; DoD HCISG V2 6.3.1; MIL-HDBK-761A, 5.1.4.4.a; MIL-STD-1801, 4.2.1.3.p
- 8.1.11.3.2** DOE HFDG ATCCS, V2.0, 5.3.2.1; DoD HCISG V2 6.3.2.1;
- 8.1.11.3.3** DOE HFDG ATCCS, V2.0, 5.3.2.4; DoD HCISG V2 6.3.2.4; MIL-HDBK-761A, 5.1.4.4.g;
- 8.1.11.3.4** DOE HFDG ATCCS, V2.0, 5.3.4.1, 5.3.4.2; DoD HCISG V2 6.3.4.1 6.3.4.2
- 8.1.11.3.5** DOE HFDG ATCCS, V2.0, 5.3.2.2; DoD HCISG V2 6.3.2.2; MIL-HDBK-761A, 5.1.4.4.e;
- 8.1.11.3.6** DOE HFDG ATCCS, V2.0, 5.3.2.3; DoD HCISG V2 6.3.2.3; MIL-HDBK-761A, 5.1.4.4.h;
- 8.1.11.3.7** DOE HFDG ATCCS, V2.0, 5.3.2.5; DoD HCISG V2 6.3.2.5;
- 8.1.11.3.8** DOE HFDG ATCCS, V2.0, 5.3.3.1; DoD HCISG V2 6.3.3.1; MIL-HDBK-761A, 5.1.4.4.c; MIL-STD-1801, 4.2.1.3.q
- 8.1.11.3.9** DOE HFDG ATCCS, V2.0, 5.3.3.2; DoD HCISG V2 6.3.3.2
- 8.1.11.3.10** DOE HFDG ATCCS, V2.0, 5.3.3.3; DoD HCISG V2 6.3.3.3; MIL-HDBK-761A, 5.1.4.4.f
- 8.1.11.3.11** DOE HFDG ATCCS, V2.0, 5.3.3.4; DoD HCISG V2 6.3.3.4; MIL-HDBK-761A, 5.1.4.4.f
- 8.1.11.3.12** MIL-HDBK-761A, 5.1.4.4.d
- 8.1.11.3.13** DOE HFDG ATCCS, V2.0, 5.3.3.7; DoD HCISG V2 6.3.3.7; MIL-HDBK-761A, 5.1.4.3.1.e; MIL-STD-1801, 4.2.1.3.t
- 8.1.11.3.14** DOE HFDG ATCCS, V2.0, 5.3.4.4; DoD HCISG V2 6.3.4.4
- 8.1.11.4.1** DOE HFDG ATCCS, V2.0, 5.1.6.1; DOD HCISG V2.0, 6.1.6.1
- 8.1.11.4.2** DOE HFDG ATCCS, V2.0, 5.1.6.2; DOD HCISG V2.0, 6.1.6.2
- 8.1.11.5.1** DOE HFDG ATCCS, V2.0, 5.1.7; DoD V2 HCISG 6.1.7
- 8.1.11.5.2** MIL-HDBK-761A, 5.1.4.1.f
- 8.1.11.6.1** New
- 8.1.11.6.2** DOE HFDG ATCCS, V2.0, 5.1.8.1; DOD HCISG V2.0, 6.1.8.1
- 8.1.11.6.3** DOE HFDG ATCCS, V2.0, 5.1.8.2; DOD HCISG V2.0, 6.1.8.2
- 8.1.11.7.1** DOE HFDG ATCCS, V2.0, 5.4.1.3; DoD HCISG V2 6.4.1.3
- 8.1.11.7.2** DOE HFDG ATCCS, V2.0, 5.4.1.1; DoD HCISG V2 6.4.1.1; MIL-HDBK-761A, 5.1.4.3.1.d
- 8.1.11.7.3** DOE HFDG ATCCS, V2.0, 5.4.1.5; DoD HCISG V2 6.4.1.5; MIL-HDBK-761A, 5.1.4.3.2.c; MIL-STD-1801, 4.2.1.3.f
- 8.1.11.7.4** DOE HFDG ATCCS, V2.0, 5.4.1.3; DoD HCISG V2 6.4.1.3; MIL-HDBK-761A, 5.1.4.f; MIL-STD-1801, 4.2.1.3.g
- 8.1.11.7.5** DOE HFDG ATCCS, V2.0, 5.4.1.6; DoD HCISG V2 6.4.1.6
- 8.1.11.7.6** DOE HFDG ATCCS, V2.0, 5.4.2.1; DoD HCISG V2 6.4.2.1
- 8.1.11.7.7** DOE HFDG ATCCS, V2.0, 5.4.2.2; DoD HCISG V2 6.4.2.2
- 8.1.11.7.8** DOE HFDG ATCCS, V2.0, 5.4.2.3; DoD HCISG V2 6.4.2.3
- 8.1.11.7.9** MIL-HDBK-761A, 5.1.4.a
- 8.1.11.8.1** DOE HFDG ATCCS, V2.0, 5.5.1.5; DoD HCISG V2 6.5.1.5
- 8.1.11.8.2** DOE HFDG ATCCS, V2.0, 5.5.1.2; DoD HCISG V2 6.5.1.2; MIL-HDBK-761A, 5.1.4.2.b; MIL-STD-1801, 4.2.1.3.h
- 8.1.11.8.3** DOE HFDG ATCCS, V2.0, 5.5.1.3; DoD HCISG V2 6.5.1.3; MIL-STD-1801, 4.2.1.3.o
- 8.1.11.8.4** DOE HFDG ATCCS, V2.0, 5.5.1.4; DoD HCISG V2 6.5.1.4
- 8.1.11.9.1** MIL-HDBK-761A, 5.1.4.3.2.b; MIL-STD-1801, 4.2.1.3.j
- 8.1.11.9.2** DOE HFDG ATCCS, V2.0, 5.5.2.6; DOD HCISG V2.0, 6.5.2.5; MIL-HDBK-761A, 5.1.4.3.2.d

- 8.1.11.9.3** DOE HFDG ATCCS, V2.0, 5.5.2.2; DOD HCISG V2.0, 6.5.2.2;
- 8.1.11.9.4** DOE HFDG ATCCS, V2.0, 5.5.2.4; DOD HCISG V2.0, 6.5.2.4;
- 8.1.11.9.5** DOD HCISG V2.0, 6.5.2.6; MIL-HDBK-761A, 5.1.4.3.1.f
- 8.1.12.1** DOE HFDG ATCCS, V2.0, 4.1.4
- 8.1.12.2** DOE HFDG ATCCS, V2.0, 4.2.1; MIL-HDBK-761A, 5.1.7.5.b; MIL-STD-1801, 4.2.1.4.e
- 8.1.12.3** DOE HFDG ATCCS, V2.0, 4.2.2
- 8.1.12.4** DOE HFDG ATCCS, V2.0, 4.1.2; MIL-HDBK-761A, 5.1.7.3.a, 5.1.7.3.b; MIL-STD-1801, 4.1.1.4.c
- 8.1.12.5** DOE HFDG ATCCS, V2.0, 4.1.5
- 8.1.12.6** DOE HFDG ATCCS, V2.0, 4.1.6
- 8.1.12.7** MIL-HDBK-761A, 5.1.7.1.c; DOE HFDG ATCCS, V2.0, 4.1.3, 4.1.7; MIL-STD-1801, 4.2.1.4.d
- 8.1.12.8** DOE HFDG ATCCS, V2.0, 4.1.9; MIL-HDBK-761A, 5.1.7.5.c
- 8.1.12.9** MIL-HDBK-761A, 5.1.7.5.d
- 8.1.12.10** DOE HFDG ATCCS, V2.0, 4.6.2; MIL-HDBK-761A, 5.1.7.5.a
- 8.1.12.11** DOE HFDG ATCCS, V2.0, 4.6.3; MIL-HDBK-761A, 5.1.7.2.a
- 8.1.12.12** DOE HFDG ATCCS, V2.0, 4.6.1; MIL-HDBK-761A, 5.1.7.2.c; MIL-STD-1801, 4.2.1.4.b
- 8.1.12.13** DOE HFDG ATCCS, V2.0, 4.3.1; MIL-HDBK-761A, 5.1.7.2.b
- 8.1.12.14** DOE HFDG ATCCS, V2.0, 4.3.2; MIL-HDBK-761A, 5.1.7.2.b
- 8.1.12.15** DOE HFDG ATCCS, V2.0, 4.4.1; MIL-HDBK-761A, 5.1.7.1.a; MIL-STD-1801, 4.2.1.4.a
- 8.1.12.16** DOE HFDG ATCCS, V2.0, 4.4.2; MIL-HDBK-761A, 5.1.7.1.b; MIL-STD-1801, 4.2.1.4.a
- 8.1.12.17** MIL-HDBK-761A, 5.1.7.1.c
- 8.1.12.18** DOE HFDG ATCCS, V2.0, 4.4.3
- 8.1.12.19** DOE HFDG ATCCS, V2.0, 4.5.1; MIL-HDBK-761A, 5.1.7.4.b
- 8.1.12.20** DOE HFDG ATCCS, V2.0, 4.5.2; MIL-HDBK-761A, 5.1.7.4.d
- 8.1.13.1** MIL-STD-1801, 4.2.1.5.b
- 8.1.13.2** MIL-HDBK-761A, 5.1.5.2.d
- 8.1.13.3** MIL-HDBK-761A, 5.1.5.2.c
- 8.1.13.4** MIL-HDBK-761A, 5.1.5.2.b; MIL-STD-1801, 4.2.1.5.c
- 8.1.13.5** DOE HFDG ATCCS, V2.0, 2.1.14.3
- 8.1.13.6** MIL-HDBK-761A, 5.1.5.2.a; MIL-STD-1801, 4.2.1.5.a
- 8.1.13.7** MIL-HDBK-761A, 5.1.5.1.a, 5.1.5.1.b, 5.1.5.1.f; MIL-STD-1801, 5.2.1.5.f
- 8.1.13.8** MIL-STD-1801, 4.2.1.5.d
- 8.1.13.9** MIL-STD-1801, 4.2.1.5.d
- 8.1.13.10** MIL-HDBK-761A, 5.1.5.3.c
- 8.1.13.11** MIL-HDBK-761A, 5.1.5.1.c
- 8.1.13.12** MIL-HDBK-761A, 5.1.5.1.d
- 8.1.13.13** MIL-HDBK-761A, 5.1.1.7.e
- 8.1.13.14** MIL-HDBK-761A, 5.1.5.1.g
- 8.1.13.15** MIL-HDBK-761A, 5.1.5.3.a
- 8.1.13.16** MIL-HDBK-761A, 5.1.5.3.b
- 8.1.13.17** MIL-HDBK-761A, 5.1.5.1.e
- 8.1.13.18** MIL-HDBK-761A, 5.1.5.b
- 8.1.13.19** MIL-HDBK-761A, 5.1.5.a
- 8.1.13.20** MIL-HDBK-761A, 5.1.5.d
- 8.1.13.21** MIL-HDBK-761A, 5.1.5.c
- 8.1.14.1.1** DOE HFDG ATCCS, V2.0, 13.1.1, 13.1.5
- 8.1.14.1.2** DOE HFDG ATCCS, V2.0, 13.1.2
- 8.1.14.1.3** MIL-HDBK-761A, 5.1.6.1.b; MIL-STD-1801, 4.2.1.6.a
- 8.1.14.1.4** MIL-HDBK-761A, 5.1.6.1.b; MIL-STD-1801, 4.2.1.6.a
- 8.1.14.1.5** DOE HFDG ATCCS, V2.0, 13.1.3
- 8.1.14.1.6** MIL-HDBK-761A, 5.1.6.2.a; MIL-STD-1801, 4.2.1.6.f
- 8.1.14.1.7** MIL-HDBK-761A, 5.1.6.2.b
- 8.1.14.1.8** MIL-HDBK-761A, 5.1.6.2.c
- 8.1.14.1.9** MIL-HDBK-761A, 5.1.6.1.c; MIL-STD-1801, 4.2.1.6.d
- 8.1.14.1.10** DOE HFDG ATCCS, V2.0, 13.1.4
- 8.1.14.1.11** DOE HFDG ATCCS, V2.0, 13.1.7
- 8.1.14.1.12** DOE HFDG ATCCS, V2.0, 13.1.9
- 8.1.14.2.1** DOE HFDG ATCCS, V2.0, 13.2
- 8.1.14.2.2** DOE HFDG ATCCS, V2.0, 13.2.1.1
- 8.1.14.2.3** DOE HFDG ATCCS, V2.0, 13.2.1.3, 13.2.2.1
- 8.1.14.3.1** DOE HFDG ATCCS, V2.0, 13.3.1.2
- 8.1.14.3.2** DOE HFDG ATCCS, V2.0, 13.3.1.4
- 8.1.14.3.3** DOE HFDG ATCCS, V2.0, 13.3.2, 13.3.3.4
- 8.1.14.3.4** DOE HFDG ATCCS, V2.0, 13.3.2.5
- 8.1.14.3.5** DOE HFDG ATCCS, V2.0, 13.3.3.1, 13.3.3.2
- 8.1.14.3.6** DOE HFDG ATCCS, V2.0, 13.3.3.3
- 8.1.14.3.7** DOE HFDG ATCCS, V2.0, 13.3.5.2
- 8.1.14.3.8** DOE HFDG ATCCS, V2.0, 13.3.5.5
- 8.1.14.4.1** DOE HFDG ATCCS, V2.0, 13.4.1.2, 13.4.1.3
- 8.1.14.4.2** DOE HFDG ATCCS, V2.0, 13.4.1.4

- 8.1.14.4.3 DOE HFDG ATCCS, V2.0, 13.4.2; New
- 8.1.14.4.4 DOE HFDG ATCCS, V2.0, 13.4.5
- 8.1.14.5.1 DOE HFDG ATCCS, V2.0, 13.5.1
- 8.1.14.5.2 DOE HFDG ATCCS, V2.0, 13.5.2
- 8.1.14.5.3 DOE HFDG ATCCS, V2.0, 13.5.4
- 8.1.14.5.4 DOE HFDG ATCCS, V2.0, 13.5.5.1
- 8.1.14.5.5 DOE HFDG ATCCS, V2.0, 13.5.5.3
- 8.1.14.5.6 DOE HFDG ATCCS, V2.0, 13.5.6
- 8.1.14.6.1 DOE HFDG ATCCS, V2.0, 13.6.1
- 8.1.14.6.2 DOE HFDG ATCCS, V2.0, 13.6.1.1
- 8.1.14.6.3 DOE HFDG ATCCS, V2.0, 13.6.1.3
- 8.1.14.6.4 DOE HFDG ATCCS, V2.0, 13.6.2, 13.6.2.1
- 8.1.14.6.5 DOE HFDG ATCCS, V2.0, 13.6.2.2
- 8.1.14.6.6 DOE HFDG ATCCS, V2.0, 13.6.2.3
- 8.1.14.6.7 DOE HFDG ATCCS, V2.0, 13.6.3.2
- 8.1.15 MIL-HDBK-761A, 5.1.8.a
- 8.1.15.1.1 MIL-HDBK-761A, 5.1.8.b
- 8.1.15.1.2 DON UISNCCS, V1.2, 4.5
- 8.1.15.1.3 MIL-HDBK-761A, 5.1.8.c
- 8.1.15.1.4 MIL-HDBK-761A, 5.1.8.d
- 8.1.15.1.5 Open Look GUIASG, p. 71
- 8.1.15.1.6 MIL-HDBK-761A, 5.1.8.e
- 8.1.15.1.7 MIL-HDBK-761A, 5.2.6.a
- 8.1.15.1.8 DON UISNCCS, V1.2, 4.5
- 8.1.15.1.9 DON UISNCCS, V1.2, 4.5
- 8.1.15.1.10 DON UISNCCS, V1.2, 4.5
- 8.1.15.1.11 DON UISNCCS, V1.2, 4.5
- 8.1.15.1.12 DON UISNCCS, V1.2, 4.5
- 8.1.15.1.13 DON UISNCCS, V1.2, 4.5
- 8.1.15.2.1 DON UISNCCS, V1.2, 6.1
- 8.1.15.2.2 DON UISNCCS, V1.2, 6.1
- 8.1.15.2.3 DON UISNCCS, V1.2, 6.1.1
- 8.1.15.2.4 DON UISNCCS, V1.2, 6.1.1
- 8.1.15.2.5 DON UISNCCS, V1.2, 6.1.1, Table 6-1
- 8.1.15.2.6 DON UISNCCS, V1.2, 6.1
- 8.1.15.2.7 DON UISNCCS, V1.2, 6.1.2
- 8.1.15.3.1 DON UISNCCS, V1.2, 6.2
- 8.1.15.3.2 DON UISNCCS, V1.2, 6.2
- 8.1.15.3.3 DON UISNCCS, V1.2, 6.2
- 8.1.15.4.1 DON UISNCCS, V1.2, 6.3
- 8.1.15.4.2 DON UISNCCS, V1.2, 6.3
- 8.1.15.5 Open Look GUIASG, p. 368
- 8.1.15.5.1 DON UISNCCS, V1.2, 6.7
- 8.1.15.5.2 DON UISNCCS, V1.2, 6.7
- 8.1.15.5.3 DON UISNCCS, V1.2, 6.7
- 8.1.15.5.4 DON UISNCCS, V1.2, 6.7
- 8.2 DOE HFDG ATCCS, V2.0, 10.0; DOD HCISG V2.0, 4.0
- 8.2.1.1.1 DOE HFDG ATCCS, V2.0, 10.0; DOD HCISG V2.0, 4.0
- 8.2.1.1.2 DOE HFDG ATCCS, V2.0, 10.0; DOD HCISG V2.0, 4.0
- 8.2.1.1.3 DOE HFDG ATCCS, V2.0, 10.0; DOD HCISG V2.0, 4.0
- 8.2.1.1.4 DOE HFDG ATCCS, V2.0, 10.1.1; DOD HCISG V2.0, 4.2.1.1
- 8.2.1.1.5 DOE HFDG ATCCS, V2.0, 10.1.2; DOD HCISG V2.0, 4.2.1.2
- 8.2.1.1.6 DOE HFDG ATCCS, V2.0, 10.3.2.4; DOD HCISG V2.0, 4.2.3.2.d
- 8.2.1.1.7 DOE HFDG ATCCS, V2.0, 10.1.3; DOD HCISG V2.0, 4.2.1.3
- 8.2.1.1.8 DOE HFDG ATCCS, V2.0, 10.1.4; DOD HCISG V2.0, 4.2.1.4
- 8.2.1.2.1 DOE HFDG ATCCS, V2.0, 10.2.1; DOD HCISG V2.0, 4.2.2.1
- 8.2.1.2.2 DOE HFDG ATCCS, V2.0, 10.2.2; DOD HCISG V2.0, 4.2.2.2
- 8.2.1.2.3 DOE HFDG ATCCS, V2.0, 10.2.3; DOD HCISG V2.0, 4.2.2.3
- 8.2.1.2.4 New
- 8.2.1.3.1 DOE HFDG ATCCS, V2.0, 2.2.1; MIL-HDBK-761A, 5.1.1.5.a
- 8.2.1.3.2 DOE HFDG ATCCS, V2.0, 2.2.6; MIL-HDBK-761A, 5.1.1.5.g
- 8.2.1.3.3 DOE HFDG ATCCS, V2.0, 2.2.5; MIL-HDBK-761A, 5.1.1.5.h, 5.1.1.5.j
- 8.2.1.3.4 MIL-HDBK-761A, 5.1.1.5.i
- 8.2.1.3.5 DOE HFDG ATCCS, V2.0, 2.2.4; MIL-HDBK-761A, 5.1.1.5.d
- 8.2.1.3.6 DOE HFDG ATCCS, V2.0, 2.1.1; MIL-HDBK-761A, 5.1.1.5.f
- 8.2.1.3.7 DOE HFDG ATCCS, V2.0, 2.2.2;
- 8.2.1.3.8 DOE HFDG ATCCS, V2.0, 2.2.3; MIL-HDBK-761A, 5.1.1.5.c
- 8.2.1.3.9 DOE HFDG ATCCS, V2.0, 2.2.7; MIL-HDBK-761A, 5.1.1.5.e
- 8.2.1.4.1 DOE HFDG ATCCS, V2.0, 10.3.2.2; DOD HCISG V2.0, 4.2.3.2.b
- 8.2.1.4.2 DOE HFDG ATCCS, V2.0, 10.3.2.3, 10.3.2.6; DOD HCISG V2.0, 4.2.3.2.c, 4.2.3.2.f
- 8.2.1.4.3 DOE HFDG ATCCS, V2.0, 10.3.2.1; DOD HCISG V2.0, 4.2.3.2.a
- 8.2.1.4.4 DOE HFDG ATCCS, V2.0, 10.3.1.2; DOD HCISG V2.0, 4.2.3.1.b

<b>8.2.1.4.5</b>	DOE HFDG ATCCS, V2.0, 10.4.5; DOD HCISG V2.0, 4.2.4.5	<b>8.2.3.5</b>	DOD HCISG V2.0, 4.2.3.5.c
<b>8.2.1.4.6</b>	DOE HFDG ATCCS, V2.0, 10.3.2.5; DOD HCISG V2.0, 4.2.3.2.e	<b>8.2.3.6</b>	DOD HCISG V2.0, 4.2.3.5.c; DOE HFDG ATCCS, V2.0, 10.3.3.5
<b>8.2.1.4.7</b>	DOE HFDG ATCCS, V2.0, 10.3.1.4; DOD HCISG V2.0, 4.2.3.1.d	<b>8.2.3.7</b>	DOD HCISG V2.0, 4.2.3.5.d
<b>8.2.1.4.8</b>	DOE HFDG ATCCS, V2.0, 10.3.1.3; DOD HCISG V2.0, 4.2.3.1.c	<b>8.2.3.8</b>	DOD HCISG V2.0, 4.2.3.5.d
<b>8.2.1.5</b>	DOE HFDG ATCCS, V2.0, 10.3.3.2, 10.4.6; DOD HCISG V2.0, 4.2.3.3.b, 4.2.4.6	<b>8.2.3.9</b>	DOD HCISG V2.0, 4.2.3.5.d
<b>8.2.1.5.1</b>	DOE HFDG ATCCS, V2.0, 10.3.3.1, 10.3.3.3; DOD HCISG V2.0, 4.2.3.3.a, 4.2.3.3.c	<b>8.2.3.10</b>	DOD HCISG V2.0, 4.2.3.5.e
<b>8.2.1.5.2</b>	DOE HFDG ATCCS, V2.0, 10.3.3.6; DOD HCISG V2.0, 4.2.3.3.f	<b>8.2.4</b>	DOD HCISG V2.0, 4.3
<b>8.2.1.5.3</b>	DOD HCISG V2.0, 4.2.4.2, 4.2.4.4	<b>8.2.4.1.1</b>	DOD HCISG V2.0, 4.3
<b>8.2.1.5.4</b>	DOD HCISG V2.0, 4.2.4.3	<b>8.2.4.1.2</b>	DOD HCISG V2.0, 4.3, 4.3.1.1
<b>8.2.1.6.1</b>	DOD HCISG V2.0, 4.2.3.6.a	<b>8.2.4.1.3</b>	DOD HCISG V2.0, 4.3.1.2
<b>8.2.1.6.2</b>	DOD HCISG V2.0, 4.2.5.1, 4.2.5.2	<b>8.2.4.1.4</b>	DOD HCISG V2.0, 4.3.2.1.a, 4.3.2.1.b
<b>8.2.1.6.3</b>	DOD HCISG V2.0, 4.2.5.3	<b>8.2.4.1.5</b>	DOD HCISG V2.0, 4.3.2.1.c
<b>8.2.1.7.1</b>	DOD HCISG V2.0, 4.1.5.1	<b>8.2.4.1.6</b>	DOD HCISG V2.0, 4.3.2.1.d
<b>8.2.1.7.2</b>	DOD HCISG V2.0, 4.2.3.3; DOE HFDG ATCCS, V2.0, 10.3.3.7	<b>8.2.4.1.7</b>	DOD HCISG V2.0, 4.3.2.2.a
<b>8.2.1.8.1</b>	DON UISNCCS, V1.2, 8.5.4	<b>8.2.4.1.8</b>	DOD HCISG V2.0, 4.3.2.1.c
<b>8.2.1.8.2</b>	DON UISNCCS, V1.2, 8.5.1.b	<b>8.2.4.1.9</b>	DOD HCISG V2.0, 4.3.2.2.c
<b>8.2.1.8.3</b>	DON UISNCCS, V1.2, 8.5.1.d	<b>8.2.4.1.10</b>	DOD HCISG V2.0, 4.3.2.3.a
<b>8.2.1.8.4</b>	DON UISNCCS, V1.2, 8.5.1.f	<b>8.2.4.1.11</b>	DOD HCISG V2.0, 4.3.2.3.b
<b>8.2.1.8.5</b>	DON UISNCCS, V1.2, 8.5.1.e	<b>8.2.4.1.12</b>	DOD HCISG V2.0, 4.3.2.3.c
<b>8.2.1.9.1</b>	DON UISNCCS, V1.2, 8.5.2	<b>8.2.4.1.13</b>	DOD HCISG V2.0, 4.3.2.4
<b>8.2.1.9.2</b>	DON UISNCCS, V1.2, 8.5.2	<b>8.2.4.1.14</b>	DOD HCISG V2.0, 4.3.2.5
<b>8.2.1.9.3</b>	DON UISNCCS, V1.2, 8.5.2	<b>8.2.4.1.15</b>	DOD HCISG V2.0, 4.3.2.8
<b>8.2.1.10.1</b>	DON UISNCCS, V1.2, 8.5.3	<b>8.2.4.1.16</b>	DOD HCISG V2.0, 4.3.2.9
<b>8.2.1.10.2</b>	DON UISNCCS, V1.2, 8.5.3	<b>8.2.4.1.17</b>	DOD HCISG V2.0, 4.3
<b>8.2.1.11.1</b>	DON UISNCCS, V1.2, 8.5.5	<b>8.2.4.1.18</b>	DOD HCISG V2.0, 4.3
<b>8.2.1.11.2</b>	DON UISNCCS, V1.2, 8.5.4.6	<b>8.2.4.1.19</b>	DOD HCISG V2.0, 4.3
<b>8.2.1.11.3</b>	DON UISNCCS, V1.2, 8.5.4.3	<b>8.2.4.1.20</b>	DOD HCISG V2.0, 4.2.3.5.f, 4.3.1.2.j
<b>8.2.1.12.1</b>	DON UISNCCS, V1.2, 8.5.6	<b>8.2.4.1.21</b>	DOD HCISG V2.0, 4.3.1.2.f
<b>8.2.1.12.2</b>	DON UISNCCS, V1.2, 8.5.6	<b>8.2.4.1.22</b>	DOD HCISG V2.0, 4.3.2.4.d, 4.3.2.7
<b>8.2.1.12.3</b>	DON UISNCCS, V1.2, 8.5.5, 8.5.6	<b>8.2.4.1.23</b>	DOD HCISG V2.0, 4.3.1.2.c
<b>8.2.2.1.1</b>	New	<b>8.2.4.1.24</b>	DOD HCISG V2.0, 4.3.1.2.h
<b>8.2.2.2.1</b>	New	<b>8.2.4.1.25</b>	DOD HCISG V2.0, 4.3.1.2.i
<b>8.2.2.2.2</b>	DOD HCISG V2.0, 4.1.1	<b>8.2.4.2.1</b>	DOD HCISG V2.0, 4.3.3.1
<b>8.2.2.2.3</b>	New	<b>8.2.4.2.2</b>	DOD HCISG V2.0, 4.3.3.2
<b>8.2.2.2.4</b>	DOD HCISG V2.0, 4.1.1	<b>8.2.4.3.1</b>	DOD HCISG V2.0, 4.3.1.2.i
<b>8.2.2.2.5</b>	New	<b>8.2.4.3.2</b>	DOD HCISG V2.0, 4.3.1.2.i
<b>8.2.2.2.6</b>	DOD HCISG V2.0, 4.1.4	<b>8.2.4.3.3</b>	DOD HCISG V2.0, 4.3.4.2
<b>8.2.2.2.7</b>	DOD HCISG V2.0, 4.1.4	<b>8.2.4.3.4</b>	DOD HCISG V2.0, 4.3.4.3
<b>8.2.2.2.8</b>	DOD HCISG V2.0, 4.1.4	<b>8.3.1.1</b>	DOE HFDG ATCCS, V2.0, 7.1.1
<b>8.2.2.2.9</b>	DOD HCISG V2.0, 4.1.4	<b>8.3.1.2</b>	DOE HFDG ATCCS, V2.0, 7.1.2.1
<b>8.2.2.3.1</b>	New	<b>8.3.1.3</b>	DOE HFDG ATCCS, V2.0, 7.1.4
<b>8.2.2.3.2</b>	DOD HCISG V2.0, 4.1.3	<b>8.3.2.1.1</b>	DON UISNCCS, V1.2, 4.1.3
<b>8.2.2.3.3</b>	New	<b>8.3.2.1.2</b>	DON UISNCCS, V1.2, 4.1.3
<b>8.2.2.3.4</b>	DOD HCISG V2.0, 4.1.3	<b>8.3.2.1.3</b>	New OSF/Motif Style Guide, 5.2.2
<b>8.2.2.3.5</b>	DOD HCISG V2.0, 4.1.3	<b>8.3.2.1.4</b>	DON UISNCCS, V1.2, 4.3.1.1
<b>8.2.3.1</b>	MIL-STD-490A, 3.2.3.1; MIL-STD-962B, 4.3.3	<b>8.3.2.2.1</b>	DON UISNCCS, V1.2, 4.1.1
<b>8.2.3.2</b>	MIL-STD-490A, 3.2.6	<b>8.3.2.3.1</b>	New
<b>8.2.3.3</b>	DOD HCISG V2.0, 4.2.3.5.c	<b>8.3.2.4.1</b>	DON UISNCCS, V1.2, 3.2.2.1, 3.2.2.4, 2.3.1
<b>8.2.3.4</b>	MIL-STD-1472D, 5.5.5.12	<b>8.3.2.4.2</b>	DON UISNCCS, V1.2, 3.2.2.1
		<b>8.3.2.4.3</b>	DON UISNCCS, V1.2, 3.2.2.4
		<b>8.3.2.4.4</b>	DON UISNCCS, V1.2, 3.2.2.1
		<b>8.3.2.4.5</b>	DON UISNCCS, V1.2, 3.2.1.3
		<b>8.3.2.4.6</b>	DON UISNCCS, V1.2, 3.4.3.1
		<b>8.3.3</b>	Open Look GUIASG, p. 355
		<b>8.3.3.1.1</b>	DON UISNCCS, V1.2, 6.8.1
		<b>8.3.3.1.2</b>	DON UISNCCS, V1.2, 6.8.1
		<b>8.3.3.2.1</b>	New
		<b>8.3.3.2.2</b>	DON UISNCCS, V1.2, 6.4
		<b>8.3.3.2.3</b>	DON UISNCCS, V1.2, 6.4

8.3.3.3.1	DON UISNCCS, V1.2, 6.6	8.3.7.3.7	DON UISNCCS, V1.2, 5.1.2.4, MIL-HDBK-761A, 5.1.4.c, 5.1.4.d
8.3.3.3.2	DON UISNCCS, V1.2, 6.6	8.3.7.4.1	DON UISNCCS, V1.2, 6.5
8.3.3.3.3	New	8.3.7.4.2	DON UISNCCS, V1.2, 6.5.1
8.3.3.3.4	DON UISNCCS, V1.2, 6.6	8.3.7.4.3	New
8.3.3.3.5	DON UISNCCS, V1.2, 6.6	8.3.7.4.4	New
8.3.4.1.1	DON UISNCCS, V1.2, 4.2.1	8.3.7.4.5	DON UISNCCS, V1.2, 6.5.3
8.3.4.1.2	DON UISNCCS, V1.2, 4.2.4	8.3.7.4.6	New
8.3.4.1.3	DON UISNCCS, V1.2, 4.2.4	8.3.8.1	DON UISNCCS, V1.2, 2.3.3.1
8.3.4.1.4	DON UISNCCS, V1.2, 4.4.2.1	8.3.8.2	DON UISNCCS, V1.2, 2.3.3.1
8.3.4.1.5	DON UISNCCS, V1.2, 4.2.3	8.3.8.3	DON UISNCCS, V1.2, 2.3.3.1
8.3.4.1.6	DON UISNCCS, V1.2, 4.3.1.4	8.3.8.4	DON UISNCCS, V1.2, 2.3.3.1
8.3.4.2.1	DON UISNCCS, V1.2, 4.2.2	8.3.8.5	DON UISNCCS, V1.2, 2.3.3.1
8.3.4.2.2	New	8.3.8.6	DON UISNCCS, V1.2, 2.3.3.2
8.3.4.2.3	DON UISNCCS, V1.2, 4.2.2	8.3.8.7	DON UISNCCS, V1.2, 2.3.3.2
8.3.4.3.1	DON UISNCCS, V1.2, 3.1.1	8.3.8.8	DON UISNCCS, V1.2, 2.3.3.1
8.3.4.3.2	DON UISNCCS, V1.2, 3.1.1	8.3.9.1.1	DON UISNCCS, V1.2, 7.1.1
8.3.4.3.3	DON UISNCCS, V1.2, 3.1.2	8.3.9.1.2	DON UISNCCS, V1.2, 7.1.2
8.3.4.3.4	DON UISNCCS, V1.2, 3.1.3	8.3.9.1.3	DON UISNCCS, V1.2, 7.1.2
8.3.4.3.5	DON UISNCCS, V1.2, 3.3	8.3.9.1.4	DON UISNCCS, V1.2, 7.1.3
8.3.4.3.6	DON UISNCCS, V1.2, 2.3.1, 3.3	8.3.9.1.5	DON UISNCCS, V1.2, 7.5.1
8.3.4.3.7	DON UISNCCS, V1.2, 3.3	8.3.9.1.6	DON UISNCCS, V1.2, 7.5.2
8.3.4.3.8	DON UISNCCS, V1.2, 2.3.1, 3.3.1	8.3.9.2.1	DON UISNCCS, V1.2, 7.2.1
8.3.4.4.1	New	8.3.9.2.2	DON UISNCCS, V1.2, 7.2.1
8.3.4.4.2	DON UISNCCS, V1.2, 4.4.2.1	8.3.9.2.3	DON UISNCCS, V1.2, 7.2.2
8.3.5	DON UISNCCS, V1.2, 3.7.2	8.3.9.3.1	DON UISNCCS, V1.2, 7.3.1
8.3.5.1	DON UISNCCS, V1.2, 4.1.2	8.3.9.3.2	DON UISNCCS, V1.2, 7.3.2
8.3.5.2	DON UISNCCS, V1.2, 4.1.2	8.3.9.3.3	DON UISNCCS, V1.1, 7.2.3
8.3.5.3	DON UISNCCS, V1.2, 4.3.1.2	8.3.9.3.4	DON UISNCCS, V1.2, 7.3.5
8.3.5.4	New	8.3.9.3.5	DON UISNCCS, V1.2, 7.3.6
8.3.5.5	DON UISNCCS, V1.2, 4.1.2	8.3.9.4.1	DON UISNCCS, V1.2, 7.4.1
8.3.5.6	DON UISNCCS, V1.2, 4.3.1.2	8.3.9.4.2	DON UISNCCS, V1.2, 7.4.1
8.3.5.7	New	8.3.9.4.3	DON UISNCCS, V1.2, 7.4.1
8.3.5.8	DON UISNCCS, V1.2, 4.1.2	8.3.9.4.4	DON UISNCCS, V1.2, 7.4.2
8.3.5.9	DON UISNCCS, V1.2, 4.3.1.4	8.3.10.1.1	DON UISNCCS, V1.2, 8.1
8.3.5.10	New	8.3.10.1.2	DON UISNCCS, V1.2, 8.1.1
8.3.5.11	DON UISNCCS, V1.2, 4.3.1.4	8.3.10.1.3	DON UISNCCS, V1.2, 8.1.2
8.3.5.12	New	8.3.10.1.4	DON UISNCCS, V1.2, 8.1.2
8.3.5.13	DON UISNCCS, V1.2, 4.1.2	8.3.10.1.5	DON UISNCCS, V1.2, 8.1.3.2
8.3.5.14	DON UISNCCS, V1.2, 4.1.2	8.3.10.1.6	DON UISNCCS, V1.2, 8.1.3.2
8.3.5.15	New	8.3.10.1.7	DON UISNCCS, V1.2, 8.1.3.3
8.3.5.16	New	8.3.10.1.8	DON UISNCCS, V1.2, 8.1.3.3
8.3.5.17	DON UISNCCS, V1.2, 3.5	8.3.10.1.9	DON UISNCCS, V1.2, 8.1.4
8.3.6.1	DOE HFDG ATCCS, V2.0, 5.3.4.4	8.3.10.1.10	DON UISNCCS, V1.2, 8.5.7
8.3.6.2	DOE HFDG ATCCS, V2.0, 7.5.1	8.3.10.1.11	DON UISNCCS, V1.2, 8.1.3.1
8.3.6.3	DOE HFDG ATCCS, V2.0, 7.5.2	8.3.10.2.1	DON UISNCCS, V1.2, 4.4.2.3
8.3.6.4	DOE HFDG ATCCS, V2.0, 7.5.3	8.3.10.2.2	DON UISNCCS, V1.2, 4.4.2.3
8.3.6.5	DOE HFDG ATCCS, V2.0, 7.5.4	8.3.10.2.3	DON UISNCCS, V1.2, 8.2.2.1
8.3.7.1.2	DON UISNCCS, V1.1, 4.1.2.2	8.3.10.2.4	DON UISNCCS, V1.2, 8.2.2.1
8.3.7.2.1	DON UISNCCS, V1.2, 5.1	8.3.10.2.5	DON UISNCCS, V1.2, 8.2.2.1
8.3.7.2.2	DON UISNCCS, V1.2, 5.1.2.5	8.3.10.2.6	DON UISNCCS, V1.2, 8.2.1
8.3.7.2.3	DON UISNCCS, V1.2, 3.2.2.4	8.3.10.2.7	DON UISNCCS, V1.2, 8.2.2.2
8.3.7.2.4	DON UISNCCS, V1.2, 3.2.2.4	8.3.10.2.8	DON UISNCCS, V1.2, 8.2.2.3
8.3.7.2.5	DON UISNCCS, V1.2, 5.1.2.5	8.3.10.2.9	DON UISNCCS, V1.2, 8.2.2.3
8.3.7.2.6	DON UISNCCS, V1.2, 3.2.2.4	8.3.10.2.10	DON UISNCCS, V1.2, 8.2.2.4
8.3.7.2.7	DON UISNCCS, V1.2, 5.1.2.5	8.3.10.2.11	DON UISNCCS, V1.2, 8.2.2.5
8.3.7.2.8	New	8.3.10.2.12	DON UISNCCS, V1.2, 8.2.2.5
8.3.7.2.9	DON UISNCCS, V1.2, 2.3.1	8.3.10.2.13	DON UISNCCS, V1.2, 8.2.2.6
8.3.7.3.1	DON UISNCCS, V1.2, 5.1, 5.1.1.1	8.3.10.2.14	DON UISNCCS, V1.2, 8.2.2.6
8.3.7.3.2	DON UISNCCS, V1.2, 5.1,	8.3.10.3.1	New
8.3.7.3.3	New	8.3.10.3.2	DON UISNCCS, V1.2, 8.3.2
8.3.7.3.4	New	8.3.10.3.3	DON UISNCCS, V1.2, 8.3.2
8.3.7.3.5	DON UISNCCS, V1.2, 5.1.2.1	8.3.10.3.4	DON UISNCCS, V1.2, 8.3.1
8.3.7.3.6	DON UISNCCS, V1.2, 5.1.2.3	8.3.10.3.5	DON UISNCCS, V1.2, 8.3.1
		8.3.10.4.1	DON UISNCCS, V1.2, 8.4.1
		8.3.10.4.2	DON UISNCCS, V1.2, 8.4.1

<b>8.3.10.4.3</b>	DON UISNCCS, V1.2, 8.4.1	<b>8.4.1.1.2</b>	MIL-HDBK-761A, 5.1.4.1.e
<b>8.3.10.4.4</b>	DON UISNCCS, V1.2, 8.4.1	<b>8.4.1.1.3</b>	New
<b>8.3.10.4.5</b>	DON UISNCCS, V1.2, 8.4.2	<b>8.4.1.1.4</b>	New
<b>8.3.10.4.6</b>	DON UISNCCS, V1.2, 8.4.2	<b>8.4.1.1.5</b>	DOE HFDG ATCCS, V2.0, 5.3.3.5; DOD HCISG V2.0, 6.3.3.5; MIL-HDBK-761A, 5.1.4.4.i; MIL-STD-1801, 4.2.1.3.s
<b>8.3.10.4.7</b>	DON UISNCCS, V1.2, 8.4.2, 8.4.3	<b>8.4.1.1.6</b>	DOE HFDG ATCCS, V2.0, 5.2.1.8; DOD HCISG V2.0, 6.2.1.8; MIL-HDBK-761A, 5.1.4.c, 5.1.4.d;
<b>8.3.10.4.8</b>	DON UISNCCS, V1.2, 8.4.3	<b>8.4.1.1.7</b>	DOE HFDG ATCCS, V2.0, 5.1.2; DOD HCISG V2.0, 6.1.2;
<b>8.3.10.4.9</b>	DON UISNCCS, V1.2, 8.4.3	<b>8.4.1.1.8</b>	DOE HFDG ATCCS, V2.0, 5.1.5; DOD HCISG V2.0, 6.1.5; MIL-HDBK-761A, 5.1.4.1.g; MIL-STD-1801, 4.2.1.3.m
<b>8.3.10.4.10</b>	DON UISNCCS, V1.2, 8.4.3	<b>8.4.1.2.1</b>	New
<b>8.3.10.4.11</b>	DON UISNCCS, V1.2, 8.4.4	<b>8.4.1.2.2</b>	New
<b>8.3.10.4.12</b>	DON UISNCCS, V1.2, 8.4.4	<b>8.4.1.3.1</b>	DOE HFDG ATCCS, V2.0, 5.1.7; DOD HCISG V2.0, 6.1.7
<b>8.3.10.4.13</b>	DON UISNCCS, V1.2, 8.4.4	<b>8.4.1.3.2</b>	MIL-HDBK-761A, 5.1.4.1.f
<b>8.3.10.4.14</b>	DON UISNCCS, V1.2, 8.4.4	<b>8.4.1.4.1</b>	New
<b>8.3.10.4.15</b>	DON UISNCCS, V1.2, 8.4.4	<b>8.4.1.4.2</b>	DOE HFDG ATCCS, V2.0, 5.1.8.1; DOD HCISG V2.0, 6.1.8.1; MIL-HDBK-761A, 5.1.4.1.f
<b>8.3.10.4.16</b>	DON UISNCCS, V1.2, 8.4.4	<b>8.4.1.4.3</b>	DOE HFDG ATCCS, V2.0, 5.1.8.3; DOD HCISG V2.0, 6.1.8.3
<b>8.3.10.4.17</b>	DON UISNCCS, V1.2, 8.4.5	<b>8.4.1.5.1</b>	DOE HFDG ATCCS, V2.0, 5.2.1.9; DOD HCISG V2.0, 6.2.1.1, 6.2.1.9; MIL-HDBK- 761A, 5.1.4.1.b; MIL-STD-1801, 4.2.1.3.b
<b>8.3.10.4.18</b>	DON UISNCCS, V1.2, 8.4.7	<b>8.4.1.5.2</b>	DOE HFDG ATCCS, V2.0, 5.2.1.2; DOD HCISG V2.0, 6.2.1.2
<b>8.3.11.1</b>	DON UISNCCS, V1.2, 8.6.1	<b>8.4.1.5.3</b>	DOE HFDG ATCCS, V2.0, 5.2.1.3; DOD HCISG V2.0, 6.2.1.3
<b>8.3.11.2</b>	DON UISNCCS, V1.2, 8.6.2	<b>8.4.1.5.4</b>	DOE HFDG ATCCS, V2.0, 5.2.1.4; DOD HCISG V2.0, 6.2.1.4
<b>8.3.11.3</b>	DON UISNCCS, V1.2, 8.6.2	<b>8.4.1.5.5</b>	DOE HFDG ATCCS, V2.0, 5.2.1.5, 5.2.1.6; DOD HCISG V2.0, 6.2.1.5, 6.2.1.6
<b>8.3.11.4</b>	DON UISNCCS, V1.2, 8.6.3	<b>8.4.1.6.1</b>	DOE HFDG ATCCS, V2.0, 5.4.1.3; DoD HCISG V2 6.4.1.3; MIL-HDBK-761A, 5.1.4.3.1.a; MIL-STD-1801, 4.2.1.3.c
<b>8.3.11.5</b>	DON UISNCCS, V1.2, 8.6.4	<b>8.4.1.6.2</b>	DOE HFDG ATCCS, V2.0, 5.4.2.1; DoD HCISG V2 6.4.2.1
<b>8.3.12.1.1</b>	DON UISNCCS, V1.2, 9.1.1	<b>8.4.1.6.3</b>	DOE HFDG ATCCS, V2.0, 5.1.8.2; DoD HCISG V2 6.1.8.2
<b>8.3.12.1.2</b>	DON UISNCCS, V1.2, 9.1.2	<b>8.4.1.6.4</b>	DOE HFDG ATCCS, V2.0, 5.4.1.1; DoD HCISG V2 6.4.1.1; MIL-HDBK-761A, 5.1.4.3.1.d;
<b>8.3.12.1.3</b>	DON UISNCCS, V1.2, 9.1.2	<b>8.4.1.6.5</b>	DOE HFDG ATCCS, V2.0, 5.4.1.5; DoD HCISG V2 6.4.1.5; MIL-HDBK-761A, 5.1.4.3.2.c; MIL-STD-1801, 4.2.1.3.f
<b>8.3.12.1.4</b>	DON UISNCCS, V1.2, 9.1.3	<b>8.4.1.6.6</b>	DOE HFDG ATCCS, V2.0, 5.4.1.4; DoD HCISG V2 6.4.1.4; MIL-HDBK-761A, 5.1.4.f; MIL- STD-1801, 4.2.1.3.g
<b>8.3.12.1.5</b>	DON UISNCCS, V1.2, 9.1.3		
<b>8.3.12.1.6</b>	DON UISNCCS, V1.2, 9.1.3		
<b>8.3.12.2.1</b>	DON UISNCCS, V1.2, 9.2.1		
<b>8.3.12.2.2</b>	DON UISNCCS, V1.2, 9.2.1		
<b>8.3.12.2.3</b>	DON UISNCCS, V1.2, 9.2.1		
<b>8.3.12.2.4</b>	DON UISNCCS, V1.2, 9.2.1		
<b>8.3.12.2.5</b>	DON UISNCCS, V1.2, 9.2.1		
<b>8.3.12.2.6</b>	DON UISNCCS, V1.2, 9.2.1		
<b>8.3.12.2.7</b>	New		
<b>8.3.12.2.8</b>	New		
<b>8.3.12.2.9</b>	New		
<b>8.3.12.2.10</b>	New		
<b>8.3.12.2.11</b>	DON UISNCCS, V1.2, 9.2.3		
<b>8.3.12.3.1</b>	DON UISNCCS, V1.2, 9.3.1		
<b>8.3.12.3.2</b>	DON UISNCCS, V1.2, 9.3.1		
<b>8.3.12.3.3</b>	DON UISNCCS, V1.2, 9.3.1		
<b>8.3.12.3.4</b>	DON UISNCCS, V1.2, 9.3.2		
<b>8.3.12.3.5</b>	DON UISNCCS, V1.2, 9.3.2		
<b>8.3.12.4.1</b>	DON UISNCCS, V1.2, 9.6.1		
<b>8.3.12.4.2</b>	DON UISNCCS, V1.2, 9.6.1		
<b>8.3.12.4.3</b>	DON UISNCCS, V1.2, 9.6.1		
<b>8.3.12.4.4</b>	DON UISNCCS, V1.2, 9.6.1		
<b>8.3.12.4.5</b>	DON UISNCCS, V1.2, 9.6.1		
<b>8.3.12.4.6</b>	DON UISNCCS, V1.2, 9.6.1		
<b>8.3.12.4.7</b>	DON UISNCCS, V1.2, 9.6.2		
<b>8.3.12.4.8</b>	DON UISNCCS, V1.2, 9.6.2		
<b>8.3.12.4.9</b>	DON UISNCCS, V1.2, 9.6.2		
<b>8.3.12.4.10</b>	DON UISNCCS, V1.2, 9.6.2		
<b>8.3.12.4.11</b>	DON UISNCCS, V1.2, 9.6.3		
<b>8.3.12.5.1</b>	DON UISNCCS, V1.2, 9.7.1		
<b>8.3.12.5.2</b>	DON UISNCCS, V1.2, 9.7.1		
<b>8.3.12.5.3</b>	DON UISNCCS, V1.2, 9.7.1		
<b>8.3.12.5.4</b>	DON UISNCCS, V1.2, 9.7.1		
<b>8.3.12.5.5</b>	DON UISNCCS, V1.2, 9.7.2		
<b>8.3.12.5.6</b>	DON UISNCCS, V1.2, 9.7.2		
<b>8.3.12.5.7</b>	DON UISNCCS, V1.2, 9.7.2		
<b>8.3.12.5.8</b>	DON UISNCCS, V1.2, 9.7.3		
<b>8.3.12.5.9</b>	DON UISNCCS, V1.2, 9.7.3		
<b>8.3.12.5.10</b>	DON UISNCCS, V1.2, 9.7.3		
<b>8.4.1.1.1</b>	DOD HCISG V2.0, 6.0; DOE HFDG ATCCS, V2.0, 5.0		

- 8.4.1.6.7** MIL-HDBK-761A, 5.1.4.a; MIL-STD-1801, 4.2.1.3.c
- 8.4.2.1.1** MIL-HDBK-761A, 5.2.3.a
- 8.4.2.1.2** MIL-HDBK-761A, 5.2.3.d
- 8.4.2.1.3** MIL-HDBK-761A, 5.2.3.1.b
- 8.4.2.1.4** MIL-HDBK-761A, 5.2.2.4.a, 5.2.4.4.b, 5.2.2.4.c
- 8.4.2.1.5** MIL-HDBK-761A, 5.2.3.1.a
- 8.4.2.1.6** MIL-HDBK-761A, 5.2.3.1.a
- 8.4.2.1.7** MIL-HDBK-761A, 5.2.3.c
- 8.4.2.1.8** DOE HFDG ATCCS, V2.0, 10.3.1.3; DOD HCISG V2.0, 4.2.3.1.c
- 8.4.2.2.1** DON UISNCCS, V1.2, 2.3.3.2
- 8.4.2.2.2** DON UISNCCS, V1.2, 2.3.3.2
- 8.4.2.2.3** MIL-HDBK-761A, 5.2.3.2.c, 5.2.3.2.d
- 8.4.2.2.4** MIL-HDBK-761A, 5.2.3.4.a, 5.2.3.4.b
- 8.4.2.2.5** MIL-HDBK-761A, 5.2.3.4.c
- 8.4.2.2.6** MIL-HDBK-761A, 5.2.3.2.a
- 8.4.2.2.7** MIL-HDBK-761A, 5.2.3.2.b
- 8.4.2.3.1** MIL-HDBK-761A, 5.2.3.b
- 8.4.2.3.2** MIL-HDBK-761A, 5.2.3.3.a
- 8.4.2.3.3** MIL-HDBK-761A, 5.2.3.3.b
- 8.4.2.3.4** MIL-HDBK-761A, 5.2.3.3.e
- 8.4.2.3.5** MIL-HDBK-761A, 5.2.3.3.c
- 8.4.2.3.6** MIL-HDBK-761A, 5.2.3.3.d, 5.2.3.3.1.a
- 8.4.2.3.7** MIL-HDBK-761A, 5.2.3.3.c, 5.2.3.3.d
- 8.4.2.4.1** DON UISNCCS, V1.2, 2.3.3.1
- 8.4.2.4.2** DON UISNCCS, V1.2, 2.3.3.1
- 8.4.2.4.3** DON UISNCCS, V1.2, 2.3.3.1
- 8.4.2.4.4** MIL-HDBK-761A, 5.2.3.3.g
- 8.4.3.1.1** DOE HFDG ATCCS, V2.0, 3.7.7
- 8.4.3.1.2** DOE HFDG ATCCS, V2.0, 3.5.2, 3.8.3
- 8.4.3.1.3** DOE HFDG ATCCS, V2.0, 3.7.3
- 8.4.3.2.1** DOE HFDG ATCCS, V2.0, 3.5.5, 3.7.5; MIL-HDBK-761A, 5.2.4.1.1.b
- 8.4.3.2.2** DOE HFDG ATCCS, V2.0, 3.5.7
- 8.4.3.2.3** DOE HFDG ATCCS, V2.0, 3.5.8; MIL-HDBK-761A, 5.2.4.1.1.c
- 8.4.3.2.4** MIL-HDBK-761A, 5.2.4.1.1.d
- 8.4.3.2.5** DOE HFDG ATCCS, V2.0, 3.7.10
- 8.4.3.2.6** DOE HFDG ATCCS, V2.0, 3.7.8; MIL-HDBK-761A, 5.2.4.1.1.e; ESD-TR-86-278, 1.4.12
- 8.4.3.2.7** DOE HFDG ATCCS, V2.0, 3.5.4; MIL-HDBK-761A, 5.2.4.1.1.a; ESD-TR-86-278, 1.4.3, 1.4.20
- 8.4.3.3.1** DOE HFDG ATCCS, V2.0, 3.5.6, 3.8.1; MIL-HDBK-761A, 5.2.4.1.2.a
- 8.4.3.3.2** MIL-HDBK-761A, 5.2.4.1.2.f
- 8.4.3.3.3** DOE HFDG ATCCS, V2.0, 3.8.5, 3.8.6
- 8.4.3.3.4** MIL-HDBK-761A, 5.2.4.1.2.a
- 8.4.3.3.5** DOE HFDG ATCCS, V2.0, 3.8.2; MIL-HDBK-761A, 5.2.4.1.2.e
- 8.4.3.3.6** DOE HFDG ATCCS, V2.0, 3.8.2; MIL-HDBK-761A, 5.2.4.1.2.b
- 8.4.3.3.7** DOE HFDG ATCCS, V2.0, 3.8.7; MIL-HDBK-761A, 5.2.4.1.2.1.a; ESD-TR-86-278, 1.4.21
- 8.4.3.3.8** MIL-HDBK-761A, 5.2.4.1.2.1.c, 5.2.4.1.2.1.d
- 8.4.3.3.9** MIL-HDBK-761A, 5.2.4.1.2.d
- 8.4.3.4.1** MIL-HDBK-761A, 5.2.4.1.b
- 8.4.3.4.2** DOE HFDG ATCCS, V2.0, 3.7.2, 3.7.6; MIL-HDBK-761A, 5.2.4.1.c
- 8.4.3.4.3** DOE HFDG ATCCS, V2.0, 3.7.1
- 8.4.3.5.1** DOE HFDG ATCCS, V2.0, 3.4.5; MIL-HDBK-761A, 5.2.4.2.a
- 8.4.3.5.2** DOE HFDG ATCCS, V2.0, 3.4.2
- 8.4.3.5.3** DOE HFDG ATCCS, V2.0, 3.4.3
- 8.4.3.5.4** DOE HFDG ATCCS, V2.0, 3.4.1
- 8.4.3.5.5** MIL-HDBK-761A, 5.2.4.2.e
- 8.4.3.5.6** MIL-HDBK-761A, 5.2.4.2.c; New
- 8.4.3.5.7** MIL-HDBK-761A, 5.2.4.2.d
- 8.4.3.6.1** New
- 8.4.3.6.2** DOE HFDG ATCCS, V2.0, 3.2.1
- 8.4.3.6.3** DOE HFDG ATCCS, V2.0, 3.2.2
- 8.4.3.7.1** MIL-HDBK-761A, 5.2.4.3.e
- 8.4.3.7.2** DOE HFDG ATCCS, V2.0, 3.5.1
- 8.4.3.7.3** MIL-HDBK-761A, 5.2.4.3.c, 5.2.4.3.d
- 8.4.3.7.4** DOE HFDG ATCCS, V2.0, 3.1.2
- 8.4.3.7.5** MIL-HDBK-761A, 5.2.4.3.b
- 8.4.3.7.6** DOE HFDG ATCCS, V2.0, 3.1.3; MIL-HDBK-761A, 5.2.4.3.b
- 8.4.3.8.1** DOE HFDG ATCCS, V2.0, 3.6.1
- 8.4.3.8.2** DOE HFDG ATCCS, V2.0, 3.6.2
- 8.4.3.8.3** MIL-HDBK-761A, 5.2.4.1.d
- 8.4.3.8.4** DOE HFDG ATCCS, V2.0, 3.5.3
- 8.4.4** DOE HFDG ATCCS, V2.0, 6.0
- 8.4.4.1** DON UISNCCS, V1.2, 3.5.1
- 8.4.4.2** DON UISNCCS, V1.2, 3.5.2
- 8.4.5.1** MIL-HDBK-761A, 5.2.5.a
- 8.4.5.2** MIL-HDBK-761A, 5.2.5.2
- 8.4.5.3** MIL-HDBK-761A, 5.2.5.d
- 8.4.5.4** MIL-HDBK-761A, 5.2.5.b, 5.2.5.c
- 8.4.5.5** MIL-HDBK-761A, 5.2.5.1
- 8.4.5.6** New
- 8.4.5.7** MIL-HDBK-761A, 5.2.5.2.b
- 8.4.5.8** MIL-HDBK-761A, 5.2.5.2.b, 5.2.5.2.c
- 8.4.6.1.1** MIL-HDBK-761A, 5.2.6.a
- 8.4.6.1.2** MIL-HDBK-761A, 5.2.6.1.a, 5.2.6.1.b
- 8.4.6.1.3** MIL-HDBK-761A, 5.2.6.1.c; DOE HFDG ATCCS, V2.0, 2.1.18.3
- 8.4.6.1.4** MIL-HDBK-761A, 5.2.6.d
- 8.4.6.1.5** MIL-HDBK-761A, 5.2.6.b
- 8.4.6.2.1** MIL-HDBK-761A, 5.2.6.2.1.a
- 8.4.6.2.2** MIL-HDBK-761A, 5.2.6.2.1.c
- 8.4.6.2.3** MIL-HDBK-761A, 5.2.6.c, 5.2.6.2.a
- 8.4.6.2.4** MIL-HDBK-761A, 5.2.6.2.1.d

- 8.4.6.2.5 MIL-HDBK-761A, 5.2.6.2.d,  
5.2.6.2.2.c
- 8.4.6.2.6 MIL-HDBK-761A, 5.2.6.3.b
- 8.4.6.2.7 MIL-HDBK-761A, 5.2.6.2.c
- 8.4.6.2.8 MIL-HDBK-761A, 5.2.6.3.a
- 8.4.6.2.9 MIL-HDBK-761A, 5.2.6.2.1.e
- 8.4.6.2.10 MIL-HDBK-761A, 5.2.6.3.e
- 8.4.6.2.11 MIL-HDBK-761A, 5.2.6.2.b
- 8.4.6.2.12 MIL-HDBK-761A, 5.2.6.2.f
- 8.4.6.2.13 MIL-HDBK-761A, 5.2.6.2.2.a
- 8.4.6.2.14 MIL-HDBK-761A, 5.2.6.2.2.b
- 8.4.6.3.1 MIL-HDBK-761A, 5.2.6.4.a
- 8.4.6.3.2 MIL-HDBK-761A, 5.2.6.4.b
- 8.4.6.3.3 MIL-HDBK-761A, 5.2.6.4.d
- 8.4.6.3.4 MIL-HDBK-761A, 5.2.6.2.1.b
- 8.4.7.1 MIL-HDBK-761A, 5.2.7.2.a
- 8.4.7.2 MIL-HDBK-761A, 5.2.7.2.b
- 8.4.7.3 MIL-HDBK-761A, 5.2.7.2.c
- 8.4.7.4 MIL-HDBK-761A, 5.2.7.2.d
- 8.5.1.1 DOE HFDG ATCCS, V2.0,  
15.7.1
- 8.5.1.2 MIL-HDBK-761A, 5.3.1.2.a
- 8.5.1.3 MIL-HDBK-761A, 5.3.1.2.b
- 8.5.1.4 MIL-HDBK-761A, 5.3.1.1.b
- 8.5.1.5 MIL-HDBK-761A, 5.3.1.1.a
- 8.5.1.6 MIL-HDBK-761A, 5.3.1.1.c
- 8.5.1.7 MIL-HDBK-761A, 5.3.1.1.d
- 8.5.1.8 MIL-HDBK-761A, 5.3.1.1.e
- 8.5.1.9 MIL-HDBK-761A, 5.3.1.1.f
- 8.5.1.10 MIL-HDBK-761A, 5.3.1.3.a
- 8.5.1.11 MIL-HDBK-761A, 5.3.1.5.b
- 8.5.1.12 MIL-HDBK-761A, 5.3.1.5.c
- 8.5.1.13 MIL-HDBK-761A, 5.3.1.5.d
- 8.5.1.14 MIL-HDBK-761A, 5.3.1.5.1.c
- 8.5.1.15 MIL-HDBK-761A, 5.3.1.5.1.d
- 8.5.1.16 MIL-HDBK-761A, 5.3.1.5.1.e
- 8.5.1.17 MIL-HDBK-761A, 5.3.1.5.1.f
- 8.5.1.18 MIL-HDBK-761A, 5.3.1.5.1.g
- 8.5.1.19 MIL-HDBK-761A, 5.3.1.5.2.a
- 8.5.1.20 MIL-HDBK-761A, 5.3.1.5.2.b
- 8.5.1.21 MIL-HDBK-761A, 5.3.1.5.2.c
- 8.5.2.1.1 MIL-HDBK-761A, 5.3.1.3.b,  
5.3.1.3.c
- 8.5.2.1.2 DON UISNCCS, V1.2, 8.4.1
- 8.5.2.2.1 MIL-HDBK-761A, 5.3.1.4.a,  
5.3.1.4.d, 5.3.1.5.1.a
- 8.5.2.2.2 MIL-HDBK-761A, 5.3.1.4.b
- 8.5.2.2.3 MIL-HDBK-761A, 5.3.1.4.e
- 8.5.2.2.4 MIL-HDBK-761A, 5.3.1.5.1.b
- 8.5.3.1 MIL-HDBK-761A, 5.3.1.5.1.h
- 8.5.4.1.1 MIL-HDBK-761A, 5.3.1.6.c
- 8.5.4.1.2 MIL-HDBK-761A, 5.3.1.6.a
- 8.5.4.1.3 MIL-HDBK-761A, 5.3.1.6.b
- 8.5.4.1.4 MIL-HDBK-761A, 5.3.1.6.d
- 8.5.4.1.5 MIL-HDBK-761A, 5.3.1.6.d
- 8.5.4.2.1 MIL-HDBK-761A, 5.3.1.6.1.a
- 8.5.4.2.2 MIL-HDBK-761A, 5.3.1.6.1.b
- 8.5.4.2.3 MIL-HDBK-761A, 5.3.1.6.1.c
- 8.5.4.2.4 MIL-HDBK-761A, 5.3.1.6.1.d
- 8.5.4.3 MIL-HDBK-761A, 5.3.1.6.2.a
- 8.5.4.3.1 MIL-HDBK-761A, 5.3.1.6.2.b
- 8.5.4.3.2 MIL-HDBK-761A, 5.3.1.6.2.b
- 8.5.4.3.3 MIL-HDBK-761A, 5.3.1.6.2.c
- 8.5.4.3.4 MIL-HDBK-761A, 5.3.1.6.2.d
- 8.5.4.3.5 MIL-HDBK-761A, 5.3.1.6.2.f
- 8.5.4.4.1 MIL-HDBK-761A, 5.3.1.6.3.a
- 8.5.4.4.2 MIL-HDBK-761A, 5.3.1.6.3.a
- 8.5.4.4.3 MIL-HDBK-761A, 5.3.1.6.3.b
- 8.5.4.5 MIL-HDBK-761A, 5.3.1.6.4.a
- 8.5.4.5.1 MIL-HDBK-761A, 5.3.1.6.4.b
- 8.5.4.5.2 MIL-HDBK-761A, 5.3.1.6.4.c
- 8.5.4.5.3 MIL-HDBK-761A, 5.3.1.6.4.d
- 8.5.4.5.4 MIL-HDBK-761A, 5.3.1.6.4.f
- 8.5.4.5.5 MIL-HDBK-761A, 5.3.1.6.4.g
- 8.5.4.6.1 MIL-HDBK-761A, 5.3.1.6.5.a
- 8.5.4.6.2 MIL-HDBK-761A, 5.3.1.6.5.b
- 8.5.4.6.3 MIL-HDBK-761A, 5.3.1.6.5.b
- 8.5.4.6.4 MIL-HDBK-761A, 5.3.1.6.5.c
- 8.5.4.6.5 MIL-HDBK-761A, 5.3.1.6.5.d
- 8.5.4.7.1 MIL-HDBK-761A, 5.3.1.6.6.c
- 8.5.4.7.2 MIL-HDBK-761A, 5.3.1.6.6.d
- 8.5.4.7.3 New
- 8.5.4.8.1 MIL-HDBK-761A, 5.3.1.6.8.b
- 8.5.4.8.2 MIL-HDBK-761A, 5.3.1.6.8.d,  
5.3.1.6.8.e
- 8.5.4.9.1 MIL-HDBK-761A, 5.3.1.6.8.f
- 8.5.4.10.1 MIL-HDBK-761A, 5.3.1.6.9
- 8.5.5.1.1 DOE HFDG ATCCS, V2.0, 9.1.1
- 8.5.5.1.2 DOE HFDG ATCCS, V2.0, 9.1.2
- 8.5.5.1.3 DOE HFDG ATCCS, V2.0, 9.1.3
- 8.5.5.1.4 DOE HFDG ATCCS, V2.0, 9.1.4
- 8.5.5.1.5 DOE HFDG ATCCS, V2.0, 9.1.5
- 8.5.5.1.6 DOE HFDG ATCCS, V2.0, 9.1.6
- 8.5.5.1.7 DOE HFDG ATCCS, V2.0, 9.1.8
- 8.5.5.1.8 DOE HFDG ATCCS, V2.0, 9.1.9
- 8.5.5.3 DOE HFDG ATCCS, V2.0, 9.2.1
- 8.5.5.3.1 DOE HFDG ATCCS, V2.0, 9.2.2
- 8.5.5.3.2 DOE HFDG ATCCS, V2.0, 9.2.3
- 8.5.5.3.3 DOE HFDG ATCCS, V2.0, 9.2.4
- 8.5.5.3.4 DOE HFDG ATCCS, V2.0, 9.2.5
- 8.5.5.3.5 DOE HFDG ATCCS, V2.0,  
9.2.6.1
- 8.5.5.3.6 DOE HFDG ATCCS, V2.0,  
9.2.6.2
- 8.5.5.3.7 DOE HFDG ATCCS, V2.0,  
9.2.6.3
- 8.5.5.3.8 DOE HFDG ATCCS, V2.0,  
9.2.6.4
- 8.5.5.3.9 DOE HFDG ATCCS, V2.0,  
9.2.6.5
- 8.5.5.3.10 DOE HFDG ATCCS, V2.0, 9.2.7
- 8.5.5.3.11 DOE HFDG ATCCS, V2.0, 9.2.8
- 8.5.5.3.12 DOE HFDG ATCCS, V2.0, 9.2.9
- 8.5.5.3.13 DOE HFDG ATCCS, V2.0,  
9.2.10, 9.2.11
- 8.5.5.3.14 DOE HFDG ATCCS, V2.0,  
9.2.12
- 8.5.5.3.15 DOE HFDG ATCCS, V2.0,  
9.2.13
- 8.5.5.4.1 DOE HFDG ATCCS, V2.0, 9.3.1
- 8.5.5.4.2 DOE HFDG ATCCS, V2.0, 9.3.2
- 8.5.5.4.3 DOE HFDG ATCCS, V2.0, 9.3.3
- 8.5.5.4.4 DOE HFDG ATCCS, V2.0, 9.3.4
- 8.5.5.4.5 DOE HFDG ATCCS, V2.0, 9.3.5
- 8.5.5.4.6 DOE HFDG ATCCS, V2.0, 9.3.6
- 8.5.5.4.7 DOE HFDG ATCCS, V2.0, 9.3.8
- 8.5.5.4.8 DOE HFDG ATCCS, V2.0,  
9.3.9, 9.3.10
- 8.5.5.4.9 DOE HFDG ATCCS, V2.0,  
9.3.11
- 8.5.5.4.10 DOE HFDG ATCCS, V2.0,  
9.3.12
- 8.5.5.4.11 DOE HFDG ATCCS, V2.0,  
9.3.13



<b>8.5.5.4.12</b>	DOE HFDG ATCCS, V2.0, 9.3.14	<b>8.5.6.4.2</b>	MIL-HDBK-761A, 5.3.2.2.2.b
<b>8.5.5.4.13</b>	DOE HFDG ATCCS, V2.0, 9.3.15	<b>8.5.6.4.3</b>	MIL-HDBK-761A, 5.3.2.2.2.c
<b>8.5.5.4.14</b>	DOE HFDG ATCCS, V2.0, 9.3.16	<b>8.5.6.4.4</b>	MIL-HDBK-761A, 5.3.2.2.2.d
<b>8.5.5.4.15</b>	DOE HFDG ATCCS, V2.0, 9.3.17	<b>8.5.6.5.1</b>	MIL-HDBK-761A, 5.3.2.2.3.a
<b>8.5.5.2.1</b>	DOE HFDG ATCCS, V2.0, 9.4.1	<b>8.5.6.5.2</b>	MIL-HDBK-761A, 5.3.2.2.3.b
<b>8.5.5.2.2</b>	DOE HFDG ATCCS, V2.0, 9.4.3	<b>8.5.6.5.3</b>	MIL-HDBK-761A, 5.3.2.2.3.c
<b>8.5.5.2.3</b>	DOE HFDG ATCCS, V2.0, 9.4.4	<b>8.5.6.6.1</b>	MIL-HDBK-761A, 5.3.2.3.a
<b>8.5.5.2.4</b>	DOE HFDG ATCCS, V2.0, 9.4.2	<b>8.5.6.6.2</b>	MIL-HDBK-761A, 5.3.2.3.b
<b>8.5.5.5.1</b>	DOE HFDG ATCCS, V2.0, 9.5.2	<b>8.5.6.6.3</b>	MIL-HDBK-761A, 5.3.2.3.c
<b>8.5.5.5.2</b>	DOE HFDG ATCCS, V2.0, 9.5.1	<b>8.5.6.6.4</b>	MIL-HDBK-761A, 5.3.2.3.f
<b>8.5.5.5.3</b>	DOE HFDG ATCCS, V2.0, 9.5.3	<b>8.5.7.1.1</b>	MIL-HDBK-761A, 5.3.2.4.a
<b>8.5.5.6.1</b>	DOE HFDG ATCCS, V2.0, 9.6.1.1	<b>8.5.7.1.2</b>	MIL-HDBK-761A, 5.3.2.4.d
<b>8.5.5.6.2</b>	DOE HFDG ATCCS, V2.0, 9.6.1.2, 9.6.1.3	<b>8.5.7.1.3</b>	MIL-HDBK-761A, 5.3.2.4.c
<b>8.5.5.6.3</b>	DOE HFDG ATCCS, V2.0, 9.6.1.4	<b>8.5.7.2.1</b>	MIL-HDBK-761A, 5.3.2.4.1.c
<b>8.5.5.6.4</b>	DOE HFDG ATCCS, V2.0, 9.6.1.6	<b>8.5.7.2.2</b>	MIL-HDBK-761A, 5.3.2.4.1.b
<b>8.5.5.6.5</b>	DOE HFDG ATCCS, V2.0, 9.6.1.5	<b>8.5.7.2.3</b>	MIL-HDBK-761A, 5.3.2.4.1.c
<b>8.5.5.7.1</b>	DOE HFDG ATCCS, V2.0, 9.6.2.1	<b>8.5.7.3.1</b>	MIL-HDBK-761A, 5.3.2.4.2.a
<b>8.5.5.7.2</b>	DOE HFDG ATCCS, V2.0, 9.6.2.2	<b>8.5.7.3.2</b>	MIL-HDBK-761A, 5.3.2.4.2.b
<b>8.5.5.7.3</b>	DOE HFDG ATCCS, V2.0, 9.6.2.3	<b>8.5.7.3.3</b>	MIL-HDBK-761A, 5.3.2.4.2.b
<b>8.5.5.8.1</b>	DOE HFDG ATCCS, V2.0, 9.6.4	<b>8.5.7.3.4</b>	MIL-HDBK-761A, 5.3.2.4.2.c
<b>8.5.5.8.2</b>	DOE HFDG ATCCS, V2.0, 9.6.4	<b>8.5.8.1.1</b>	DOE HFDG ATCCS, V2.0, 8.0
<b>8.5.5.9.1</b>	DOE HFDG ATCCS, V2.0, 9.6.5	<b>8.5.8.1.2</b>	DOE HFDG ATCCS, V2.0, 8.0
<b>8.5.5.9.2</b>	DOE HFDG ATCCS, V2.0, 9.6.5	<b>8.5.8.1.3</b>	DOE HFDG ATCCS, V2.0, 8.0
<b>8.5.5.9.3</b>	DOE HFDG ATCCS, V2.0, 9.6.5.1	<b>8.5.8.1.4</b>	DOE HFDG ATCCS, V2.0, 8.1.1
<b>8.5.5.9.4</b>	DOE HFDG ATCCS, V2.0, 9.6.5.2	<b>8.5.8.1.5</b>	DOE HFDG ATCCS, V2.0, 8.1.2
<b>8.5.5.10.1</b>	DOE HFDG ATCCS, V2.0, 9.7.2	<b>8.5.8.1.6</b>	DOE HFDG ATCCS, V2.0, 8.1.3
<b>8.5.5.11.1</b>	DOE HFDG ATCCS, V2.0, 9.8.1.1	<b>8.5.8.1.7</b>	DOE HFDG ATCCS, V2.0, 8.1.3
<b>8.5.5.11.2</b>	DOE HFDG ATCCS, V2.0, 9.8.1.2	<b>8.5.8.1.8</b>	DOE HFDG ATCCS, V2.0, 8.1.4
<b>8.5.5.11.3</b>	DOE HFDG ATCCS, V2.0, 9.8.1.3	<b>8.5.8.1.9</b>	DOE HFDG ATCCS, V2.0, 8.1.5
<b>8.5.5.12</b>	DOE HFDG ATCCS, V2.0, 9.8.2	<b>8.5.8.1.10</b>	DOE HFDG ATCCS, V2.0, 8.1.6
<b>8.5.5.12.1</b>	DOE HFDG ATCCS, V2.0, 9.8.2.1	<b>8.5.8.2.1</b>	DOE HFDG ATCCS, V2.0, 8.2.1
<b>8.5.5.12.2</b>	DOE HFDG ATCCS, V2.0, 9.8.2.7	<b>8.5.8.2.2</b>	DOE HFDG ATCCS, V2.0, 8.2.1.1
<b>8.5.5.12.3</b>	DOE HFDG ATCCS, V2.0, 9.8.2.5	<b>8.5.8.2.3</b>	DOE HFDG ATCCS, V2.0, 8.2.1.2
<b>8.5.5.12.4</b>	DOE HFDG ATCCS, V2.0, 9.8.2.6	<b>8.5.8.2.4</b>	DOE HFDG ATCCS, V2.0, 8.2.1.3
<b>8.5.5.12.5</b>	DOE HFDG ATCCS, V2.0, 9.8.2.2	<b>8.5.8.2.5</b>	DOE HFDG ATCCS, V2.0, 8.2.2.1
<b>8.5.6.1.1</b>	MIL-HDBK-761A, 5.3.2.a	<b>8.5.8.2.6</b>	DOE HFDG ATCCS, V2.0, 8.2.2.2
<b>8.5.6.1.2</b>	MIL-HDBK-761A, 5.3.2.a	<b>8.5.8.2.7</b>	DOE HFDG ATCCS, V2.0, 8.2.3.2
<b>8.5.6.2.1</b>	MIL-HDBK-761A, 5.3.2.1.a	<b>8.5.8.2.8</b>	DOE HFDG ATCCS, V2.0, 8.2.3.3
<b>8.5.6.2.2</b>	MIL-HDBK-761A, 5.3.2.1.b	<b>8.5.8.2.9</b>	DOE HFDG ATCCS, V2.0, 8.2.3.4
<b>8.5.6.2.3</b>	MIL-HDBK-761A, 5.3.2.1.c	<b>8.5.8.2.10</b>	DOE HFDG ATCCS, V2.0, 8.2.3.5
<b>8.5.6.3.1</b>	MIL-HDBK-761A, 5.3.2.2.a	<b>8.5.8.2.11</b>	DOE HFDG ATCCS, V2.0, 8.2.4
<b>8.5.6.3.2</b>	MIL-HDBK-761A, 5.3.2.2.b, 5.3.2.2.1	<b>8.5.8.2.12</b>	DOE HFDG ATCCS, V2.0, 8.2.4.1
<b>8.5.6.3.3</b>	MIL-HDBK-761A, 5.3.2.2.c	<b>8.5.8.2.13</b>	DOE HFDG ATCCS, V2.0, 8.2.4.2
<b>8.5.6.4.1</b>	MIL-HDBK-761A, 5.3.2.2.2.a	<b>8.5.8.2.14</b>	DOE HFDG ATCCS, V2.0, 8.2.4.3
		<b>8.5.8.2.15</b>	DOE HFDG ATCCS, V2.0, 8.2.4.4
		<b>8.5.8.3.1</b>	DOE HFDG ATCCS, V2.0, 8.3.1.1
		<b>8.5.8.3.2</b>	DOE HFDG ATCCS, V2.0, 8.3.1.2
		<b>8.5.8.3.3</b>	DOE HFDG ATCCS, V2.0, 8.3.1.3
		<b>8.5.8.3.4</b>	DOE HFDG ATCCS, V2.0, 8.3.2.1

- 8.5.8.3.5** DOE HFDG ATCCS, V2.0, 8.3.2.2  
**8.5.8.3.6** DOE HFDG ATCCS, V2.0, 8.3.2.4  
**8.5.8.3.7** DOE HFDG ATCCS, V2.0, 8.3.2.5  
**8.5.8.3.8** DOE HFDG ATCCS, V2.0, 8.3.2.6  
**8.5.8.3.9** DOE HFDG ATCCS, V2.0, 8.3.2.7  
**8.5.8.3.10** DOE HFDG ATCCS, V2.0, 8.3.3.1  
**8.5.8.3.11** DOE HFDG ATCCS, V2.0, 8.3.3.2  
**8.5.8.3.12** DOE HFDG ATCCS, V2.0, 8.3.3.3  
**8.5.8.3.13** DOE HFDG ATCCS, V2.0, 8.3.3.4  
**8.5.8.3.14** DOE HFDG ATCCS, V2.0, 8.3.3.5  
**8.5.8.3.15** DOE HFDG ATCCS, V2.0, 8.3.3.6  
**8.5.8.3.16** DOE HFDG ATCCS, V2.0, 8.3.4.5  
**8.5.8.3.17** DOE HFDG ATCCS, V2.0, 8.3.4.2  
**8.5.8.3.18** DOE HFDG ATCCS, V2.0, 8.3.4.3  
**8.5.8.3.19** DOE HFDG ATCCS, V2.0, 8.3.4.4  
**8.5.8.3.20** DOE HFDG ATCCS, V2.0, 8.3.5  
**8.5.8.3.21** DOE HFDG ATCCS, V2.0, 8.3.6  
**8.5.8.4.1** DOE HFDG ATCCS, V2.0, 8.4.1  
**8.5.8.4.2** DOE HFDG ATCCS, V2.0, 8.4.2  
**8.5.8.4.3** DOE HFDG ATCCS, V2.0, 8.4.3  
**8.5.8.4.4** DOE HFDG ATCCS, V2.0, 8.4.5.1  
**8.5.8.4.5** DOE HFDG ATCCS, V2.0, 8.4.5.2  
**8.5.8.4.6**  
    **a.** DOE HFDG ATCCS, V2.0, 8.4.5.3  
    **b.** DOE HFDG ATCCS, V2.0, 8.4.5.4  
    **c.** DOE HFDG ATCCS, V2.0, 8.4.5.5  
    **d.** DOE HFDG ATCCS, V2.0, 8.4.5.9  
**8.5.8.4.7** DOE HFDG ATCCS, V2.0, 8.4.5.7  
**8.5.8.4.8** DOE HFDG ATCCS, V2.0, 8.4.5.8  
**8.5.8.4.9** DOE HFDG ATCCS, V2.0, 8.4.5.6  
**8.5.8.4.10** DOE HFDG ATCCS, V2.0, 8.4.4  
**8.5.8.5.1** DOE HFDG ATCCS, V2.0, 8.5.2  
**8.5.8.5.2** DOE HFDG ATCCS, V2.0, 8.5.3  
**8.5.8.5.3** DOE HFDG ATCCS, V2.0, 8.5.4.1  
**8.5.8.5.4** DOE HFDG ATCCS, V2.0, 8.5.4.2  
**8.5.8.5.5** DOE HFDG ATCCS, V2.0, 8.5.5  
**8.5.8.5.6** DOE HFDG ATCCS, V2.0, 8.5.4.1  
**8.5.8.5.7** DOE HFDG ATCCS, V2.0, 8.5.1  
**8.5.9** MIL-HDBK-761A, 5.3.3  
**8.5.9.1.1** MIL-HDBK-761A, 5.3.3.1.a  
**8.5.9.1.2** MIL-HDBK-761A, 5.3.3.1.b  
**8.5.9.1.3** MIL-HDBK-761A, 5.3.3.1.c  
**8.5.9.1.4** MIL-HDBK-761A, 5.3.3.1.e  
**8.5.9.2.1** MIL-HDBK-761A, 5.3.3.2.a  
**8.5.9.2.2** MIL-HDBK-761A, 5.3.3.2.a  
**8.5.9.2.2** MIL-HDBK-761A, 5.3.1.6.2.g  
**8.5.9.2.3** MIL-HDBK-761A, 5.3.3.2.d  
**8.5.9.2.4** MIL-HDBK-761A, 5.3.3.2.b  
**8.5.9.2.5** MIL-HDBK-761A, 5.3.3.2.c  
**8.5.9.2.6** MIL-HDBK-761A, 5.3.3.2.c  
**8.6.1** DOD HCISG V2.0, 14.1.1, 14.1.3  
**8.6.1.1.1** MIL-HDBK-761A, 5.4.1  
**8.6.1.1.2** DOE HFDG ATCCS, V2.0, 14.3.1; MIL-HDBK-761A, 5.4.2.2; DOD HCISG V2.0, 8.2.3.1; MIL-STD-1801, 4.6.5.1  
**8.6.1.1.3** MIL-STD-1801, 4.6.5.4  
**8.6.1.1.4** DOD HCISG V2.0, 8.2.5.6; DOE HFDG ATCCS, V2.0, 14.5.6  
**8.6.1.1.5** DOD HCISG V2.0, 8.2.8.1; MIL-HDBK-761A, 5.4.1.2.a  
**8.6.1.1.6** DOD HCISG V2.0, 8.2.6.4, 8.2.6.5; DOE HFDG ATCCS, V2.0, 14.6.4, 14.6.5  
**8.6.1.1.7** MIL-HDBK-761A, 5.4.1.2.b  
**8.6.1.1.8** MIL-STD-1801, 4.6.5.3  
**8.6.1.1.9** MIL-HDBK-761A, 5.4.1.1.b  
**8.6.1.1.10** DOD HCISG V2.0, 8.2.12.1.c; DOE HFDG ATCCS, V2.0, 14.12.2; MIL-STD-1801, 4.6.5.4  
**8.6.1.1.11** MIL-STD-1801, 4.6.5.5.c  
**8.6.1.1.12** DOE HFDG ATCCS, V2.0, 14.7.3; DOD HCISG V2.0, 8.2.7.3  
**8.6.1.1.13** DOE HFDG ATCCS, V2.0, 14.7.1; DOD HCISG V2.0, 8.2.7.1  
**8.6.1.2.1** DOD HCISG V2.0, 8.2.6.3; DOE HFDG ATCCS, V2.0, 14.6.3  
**8.6.1.2.2** DOD HCISG V2.0, 8.2.3.2; DOE HFDG ATCCS, V2.0, 14.3.2  
**8.6.1.2.3** DOD HCISG V2.0, 8.2.3.3; DOE HFDG ATCCS, V2.0, 14.3.3  
**8.6.1.2.4** MIL-HDBK-761A, 5.4.2.1.a  
**8.6.1.2.5** DOD HCISG V2.0, 8.2.8.2; DOE HFDG ATCCS, V2.0, 14.8.1  
**8.6.1.2.6** MIL-HDBK-761A, 5.4.2.2.2.f  
**8.6.1.2.7** MIL-STD-1801, 4.6.5.5  
**8.6.1.2.8** MIL-HDBK-761A, 5.4.1.1.d  
**8.6.1.2.9** DOD HCISG V2.0, 8.2.10.2; DOE HFDG ATCCS, V2.0, 14.10.1, 14.10.2; MIL-HDBK-761A, 5.4.2.1.e  
**8.6.1.2.10** MIL-HDBK-761A, 5.4.2.2.2.c  
**8.6.1.2.11** DOD HCISG V2.0, 8.2.2.1, 8.2.3.4, 8.2.10.1; DOE HFDG ATCCS, V2.0, 14.3.4  
**8.6.1.2.12** DOD HCISG V2.0, 8.2.12.1; DOE HFDG ATCCS, V2.0, 14.2.1  
**8.6.1.2.13** MIL-HDBK-761A, 5.4.2.1.b  
**8.6.1.3.1** MIL-HDBK-761A, 5.4.2.1.d; MIL-STD-1801, 4.6.5.5.a  
**8.6.1.3.2** MIL-HDBK-761A, 5.4.1.2.d  
**8.6.1.3.3** MIL-HDBK-761A, 5.4.2.2.2.e(2)  
**8.6.1.3.4** DOD HCISG V2.0, 8.2.6.2; DOE HFDG ATCCS, V2.0, 14.6.2

- 8.6.1.3.5** MIL-HDBK-761A, 5.4.2.2.2.f(2)  
**8.6.1.5.1** DOE HFDG ATCCS, V2.0, 14.2.2, 14.2.6; DOD HCISG, V2.0, 8.2.2.2, 8.2.2.6, 8.2.2.9  
**8.6.1.5.2** DOE HFDG ATCCS, V2.0, 14.9.3; DOD HCISG, V2.0, 8.2.9.3  
**8.6.1.5.3** MIL-HDBK-761A, 5.4.2.1.c; MIL-STD-1801, 4.6.5.5.b  
**8.6.1.5.4** DOE HFDG ATCCS, V2.0, 14.9.1, 14.9.2; DOD HCISG, V2.0, 8.2.9.2  
**8.6.1.5.5** DOE HFDG ATCCS, V2.0, 14.9.1, 14.9.2; DOD HCISG, V2.0, 8.2.9.1, 8.2.9.2  
**8.6.1.5.6** MIL-HDBK-761A, 5.4.2.2.2.e  
**8.6.1.5.7** DOD HCISG, V2.0, 8.2.5  
**8.6.1.5.8** DOE HFDG ATCCS, V2.0, 14.4.2; DOD HCISG, V2.0, 8.2.4.2; MIL-HDBK-761A, 5.4.2.2.2.b  
**8.6.1.5.9** DOE HFDG ATCCS, V2.0, 14.5.4; DOD HCISG, V2.0, 8.2.5.4  
**8.6.1.5.10** DOE HFDG ATCCS, V2.0, 14.5.5; DOD HCISG, V2.0, 8.2.5.5  
**8.6.1.5.11** DOD HCISG, V2.0, 8.2.6.6  
**8.6.1.5.12** DOE HFDG ATCCS, V2.0, 14.5.3; DOD HCISG, V2.0, 8.2.5.3  
**8.6.1.5.13** DOE HFDG ATCCS, V2.0, 14.5.2; DOD HCISG, V2.0, 8.2.5.2  
**8.6.1.5.14** DOE HFDG ATCCS, V2.0, 14.5.1; DOD HCISG, V2.0, 8.2.5.1  
**8.6.1.5.15** DOE HFDG ATCCS, V2.0, 14.4.1; DOD HCISG, V2.0, 8.2.4.1; MIL-HDBK-761A, 5.4.2.2.2.d(2)  
**8.6.1.5.16** DOE HFDG ATCCS, V2.0, 14.7.4; DOD HCISG, V2.0, 8.2.7.4  
**8.7.1.1** MIL-HDBK-761A, 5.6.1.1.a  
**8.7.1.2** MIL-HDBK-761A, 5.6.1.1.b  
**8.7.1.3** MIL-HDBK-761A, 5.6.1.1.c  
**8.7.1.4** MIL-HDBK-761A, 5.6.1.1.d  
**8.7.1.5** MIL-HDBK-761A, 5.6.1.1.e  
**8.7.1.6** MIL-HDBK-761A, 5.6.1.1.f  
**8.7.1.7** MIL-HDBK-761A, 5.6.1.1.b  
**8.7.2.1.1** MIL-HDBK-761A, 5.6.2.1  
**8.7.2.1.2** MIL-HDBK-761A, 5.6.3.1.4.c  
**8.7.2.2.1** MIL-HDBK-761A, 5.6.2.2.b  
**8.7.2.2.2** MIL-HDBK-761A, 5.6.2.2.a  
**8.7.2.2.3** MIL-HDBK-761A, 5.6.2.2.c  
**8.7.2.3.1** MIL-HDBK-761A, 5.6.2.3.a  
**8.7.2.3.2** MIL-HDBK-761A, 5.6.2.3.b  
**8.7.3.1.1** MIL-HDBK-761A, 5.6.3.1.1.a  
**8.7.3.1.2** MIL-HDBK-761A, 5.6.3.1.1.b  
**8.7.3.1.3** MIL-HDBK-761A, 5.6.3.2.3.a  
**8.7.3.2.1** MIL-HDBK-761A, 5.6.3.1.2.a  
**8.7.3.2.2** MIL-HDBK-761A, 5.6.3.1.2.b  
**8.7.3.3.1** MIL-HDBK-761A, 5.6.3.1.3.a  
**8.7.3.3.2** MIL-HDBK-761A, 5.6.3.1.3.b  
**8.7.3.3.3** MIL-HDBK-761A, 5.6.3.1.3.c  
**8.7.3.4.1** MIL-HDBK-761A, 5.6.3.1.4.a  
**8.7.3.4.2** MIL-HDBK-761A, 5.6.3.1.4.b  
**8.7.4.2.1** MIL-HDBK-761A, 5.6.3.2.2.a  
**8.7.4.2.2** MIL-HDBK-761A, 5.6.3.2.2.b  
**8.7.4.2.3** MIL-HDBK-761A, 5.6.3.2.2.c  
**8.7.4.2.4** MIL-HDBK-761A, 5.6.3.2.2.a  
**8.7.4.2.5** MIL-HDBK-761A, 5.6.3.2.2.d  
**8.7.4.2.6** MIL-HDBK-761A, 5.6.3.2.2.e  
**8.7.5.1.1** MIL-HDBK-761A, 5.6.3.2.2.c  
**8.7.5.2.1** MIL-HDBK-761A, 5.6.3.2.2.a  
**8.7.5.2.1** MIL-HDBK-761A, 5.6.3.2.2.b  
**8.7.5.3.1** MIL-HDBK-761A, 5.6.3.4.a  
**8.7.5.3.2** MIL-HDBK-761A, 5.6.3.4.b  
**8.7.6.1.1** MIL-HDBK-761A, 5.6.4.1.a  
**8.7.6.1.2** MIL-HDBK-761A, 5.6.4.1.b  
**8.7.6.2.1** MIL-HDBK-761A, 5.6.4.2.a  
**8.7.6.2.2** MIL-HDBK-761A, 5.6.4.2.b  
**8.7.6.2.3** MIL-HDBK-761A, 5.6.4.2.c  
**8.7.6.2.4** MIL-HDBK-761A, 5.6.4.2.d  
**8.7.6.3.1** MIL-HDBK-761A, 5.6.4.3.a  
**8.7.6.3.2** MIL-HDBK-761A, 5.6.4.3.c  
**8.7.6.3.3** MIL-HDBK-761A, 5.6.4.3.b  
**8.7.6.3.4** MIL-HDBK-761A, 5.6.4.3.d  
**8.7.6.3.5** MIL-HDBK-761A, 5.6.4.3.e  
**8.7.6.3.6** MIL-HDBK-761A, 5.6.4.3.f  
**8.7.6.4.1** MIL-HDBK-761A, 5.6.4.4.b  
**8.7.6.4.2** MIL-HDBK-761A, 5.6.4.4.a  
**8.7.6.5.1** MIL-HDBK-761A, 5.6.4.5.a  
**8.7.6.5.2** MIL-HDBK-761A, 5.6.4.5.b  
**8.7.6.5.3** MIL-HDBK-761A, 5.6.4.5.c  
**8.7.6.6.1** MIL-HDBK-761A, 5.6.4.6  
**8.8.1.1** MIL-STD-1472D, 5.15.2.2.1, 5.15.2.2.2; MIL-STD-1801, 4.1.5.1  
**8.8.1.2** MIL-STD-1472D, 5.15.2.2.6; MIL-STD-1801, 4.1.5.3  
**8.8.1.3** New  
**8.8.1.4** NUREG-0700, 6.7.1.4.i; DOE-STAND HFAC 1, 5.4.1.8  
**8.8.1.5** NASA-STD-3000A, 9.3.3.4.1.1; DOE-STAND HFAC 1, 5.4.1.12  
**8.8.1.6** MIL-STD-1472D, 5.15.2.2.9; DOE-STAND HFAC 1, 5.4.1.11  
**8.8.1.7** DISA HCISG, V1.0, 3.2  
**8.8.1.8** DISA HCISG, V1.0, 3.2  
**8.8.2.1** MIL-STD-1472D, 5.15.2.3.2; DOE-STAND HFAC 1, 5.4.1.13.2  
**8.8.2.2** MIL-STD-1472D, 5.15.2.3.4; DOE-STAND HFAC 1, 5.4.1.13.4  
**8.8.2.3** MIL-STD-1472D, 5.15.2.3.5; DOE-STAND HFAC 1, 5.4.1.13.5  
**8.8.2.4** MIL-STD-1472D, 5.15.2.3.6; DOE-STAND HFAC 1, 5.4.1.13.6  
**8.8.3.1.1** DON UISNCCS, V1.2, 2.2.1  
**8.8.3.1.2** DON UISNCCS, V1.2, 2.2.1  
**8.8.3.1.3** DON UISNCCS, V1.2, 2.2.1  
**8.8.3.1.4** DON UISNCCS, V1.2, 2.2.1  
**8.8.3.1.5** DON UISNCCS, V1.2, 2.2.1  
**8.8.3.1.6** DON UISNCCS, V1.2, 2.2.1  
**8.8.3.1.7** DON UISNCCS, V1.2, 2.2.1  
**8.8.3.1.8** New; MIL-STD-1472D, 5.15.2.5.1, 5.15.2.6.1; MIL-STD-1801, 4.1.5.4, 4.1.5.5, 4.1.5.7

- 8.8.3.2.1 MIL-STD-1472D, 5.4.3.2.6.1;  
DOE-STAND HFAC 1, 5.4.2.3.1
- 8.8.3.2.2 MIL-STD-1472D, 5.4.3.2.6.2;  
DOE-STAND HFAC 1, 5.4.2.3.2
- 8.8.3.2.3 MIL-STD-1472D, 5.4.3.2.6.2;  
DOE-STAND HFAC 1, 5.4.2.3.2
- 8.8.3.2.4 MIL-STD-1472D, 5.4.3.2.6.2;  
DOE-STAND HFAC 1, 5.4.2.3.2
- 8.8.3.2.5 MIL-STD-1472D, 5.4.3.2.6.3;  
DOE-STAND HFAC 1, 5.4.2.3.3
- 8.8.3.3.1 MIL-STD-1472D, 5.15.2.6.1;  
DOE-STAND HFAC 1, 5.4.2.1
- 8.8.3.3.2 MIL-STD-1472D, 5.15.2.6.2;  
DOE-STAND HFAC 1, 5.4.2.2
- 8.8.3.4 MIL-STD-1472D, 5.4.3.2.7.1;  
DOE-STAND HFAC 1, 5.4.3.1
- 8.8.3.4.1 MIL-STD-1472D, 5.4.3.2.7.2;
- 8.8.3.4.2 MIL-STD-1472D, 5.4.3.2.7.3;  
DOE-STAND HFAC 1, 5.4.3.3
- 8.8.3.4.3 MIL-STD-1472D, 5.15.2.5.3  
DOE-STAND HFAC 1, 5.4.3.4
- 8.8.3.4.4 MIL-STD-1472D, 5.15.2.5.4;  
DOE-STAND HFAC 1, 5.4.3.5
- 8.8.3.5 NASA-STD-3000A, 9.3.3.4.6;  
DOE-STAND HFAC 1, 5.4.4.1
- 8.8.3.5.1 NASA-STD-3000A, 9.3.3.4.6;  
DOE-STAND HFAC 1, 5.4.4.3
- 8.8.3.5.2 NASA-STD-3000A, 9.3.3.4.6;  
DOE-STAND HFAC 1, 5.4.4.4
- 8.8.3.5.3 NASA-STD-3000A, 9.3.3.4.6;  
DOE-STAND HFAC 1, 5.4.4.5
- 8.8.3.6.1 DON UISNCCS, V1.2, 2.2.2
- 8.8.3.6.2 DON UISNCCS, V1.2, 2.2.1
- 8.8.3.6.3 DON UISNCCS, V1.2, 2.2.1
- 8.8.3.6.4 DON UISNCCS, V1.2, 2.2.2
- 8.8.3.7.1 DON UISNCCS, V1.2, 2.2.3
- 8.8.3.7.2 DON UISNCCS, V1.2, 2.2.3
- 8.8.3.7.3 DON UISNCCS, V1.2, 2.2.3
- 8.8.4.1.1 DON UISNCCS, V1.2, 2.4
- 8.8.4.1.2 MIL-STD-1801, 4.1.5.8, 4.1.5.9,  
4.1.5.10
- 8.8.4.2.1 MIL-STD-1472D, 5.4.6.1; DOE-  
STAND HFAC 1, 5.4.5.1
- 8.8.4.2.2 New
- 8.8.4.2.3 MIL-STD-1472D, 5.4.6.2; DOE-  
STAND HFAC 1, 5.4.5.2
- 8.8.4.2.4 MIL-STD-1472D, 5.4.6.3; DOE-  
STAND HFAC 1, 5.4.5.3
- 8.8.4.2.5 MIL-STD-1472D, 5.4.3.1.5.1;  
DOE-STAND HFAC 1, 5.3.12.1
- 8.8.4.2.6 DOE-STAND HFAC 1, 5.4.5.5
- 8.8.4.2.7 MIL-STD-1472D, 5.4.6.6
- 8.8.4.3.1 New
- 8.8.4.3.2 New
- 8.8.4.3.3 New
- 8.8.5.1 DON UISNCCS, V1.2, 2.1
- 8.9 Vanderheiden & Vanderheiden,  
1991, pp. 1-2; Public Law 101-  
336, 7/26/1990, Section 101  
Vanderheiden, 1990, pp. 383-396;  
Vanderheiden & Vanderheiden,  
1991, p. 16-17
- 8.9.1.1 Benel, 1988, p. 271; Ladner,  
1988, p. 220
- 8.9.1.2 Benel, 1988, p. 271
- 8.9.1.3 Benel, 1988, p. 271
- 8.9.2 Scadden & Vanderheiden, 1988, p.  
12
- 8.9.2.1 Scadden & Vanderheiden, 1988,  
P-1, pp. 13-14
- 8.9.2.2 Scadden & Vanderheiden, 1988,  
P-2, p. 15
- 8.9.2.3 Scadden & Vanderheiden, 1988,  
P-3, p. 16
- 8.9.2.4 Casali, Proc. of the HFS, 36, 311-  
315
- 8.9.2.5 Casali, Proc. of the HFS, 36, 311-  
315
- 8.9.2.6 Scadden & Vanderheiden, 1988,  
P-4, pp. 17-18
- 8.9.2.7 Scadden & Vanderheiden, 1988,  
P-5, pp. 19-20
- 8.9.2.8 Scadden & Vanderheiden, 1988,  
P-6, pp. 21-22
- 8.9.3 Scadden & Vanderheiden, 1988, p.  
23
- 8.9.3.1 Scadden & Vanderheiden, 1988,  
SP-1, pp. 24-25
- 8.9.4.1 Scadden & Vanderheiden, 1988,  
V-1, pp. 27-28
- 8.9.4.2 Scadden & Vanderheiden, 1988,  
V-2, p. 29
- 8.9.4.3 Scadden & Vanderheiden, 1988,  
V-3, p. 30
- 8.9.5 Scadden & Vanderheiden, 1988, p.  
31
- 8.9.5.1 Scadden & Vanderheiden, 1988,  
B-1, pp. 32-33
- 8.9.5.2 Scadden & Vanderheiden, 1988,  
B-2, p. 34
- 8.9.5.3 Scadden & Vanderheiden, 1988,  
B-3, pp. 35-36
- 8.9.5.4 Scadden & Vanderheiden, 1988,  
B-4, pp. 37-38
- 8.9.5.5 Scadden & Vanderheiden, 1988,  
B-4, pp. 37-38
- 8.9.5.6 Scadden & Vanderheiden, 1988,  
B-4, pp. 37-38
- 8.9.6 Scadden & Vanderheiden, 1988, p.  
39
- 8.9.6.1.1 Scadden & Vanderheiden, 1988,  
H-1, pp. 40-41
- 8.9.6.1.2 Vanderheiden & Vanderheiden,  
1991, O-1, pp. 20-21
- 8.9.6.2.1 Mynatt & Edwards, 1992, 61-70
- 8.9.6.2.2 Mynatt & Edwards, 1992, 61-70
- 8.9.6.2.3 Mynatt & Edwards, 1992, 61-70
- 8.9.6.2.4 Edwards, 1988, p. 84
- 8.9.6.2.5 Edwards, 1988, p. 84
- 8.9.6.2.6 Edwards, 1988, p. 84
- 8.9.6.2.7 Edwards, 1988, p. 84
- 8.9.6.2.8 Edwards, 1988, p. 85
- 8.9.7.1 Vanderheiden & Vanderheiden,  
1991, O-7, p. 36
- 8.9.8.1 Scadden & Vanderheiden, 1988,  
M-1, p. 48
- 8.9.8.2 Scadden & Vanderheiden, 1988,  
M-2, p. 49
- 8.9.8.3 Scadden & Vanderheiden, 1988,  
M-3, p. 50
- 8.9.8.4 Scadden & Vanderheiden, 1988,  
M-4, p. 51

- 8.9.8.5** Scadden & Vanderheiden, 1988, M-5, p. 52
- 8.9.8.6** Scadden & Vanderheiden, 1988, M-6, p. 53
- 9** SMEs 10, 21, 23, 24
- 9.1.1** NASA-STD-3000A, 9.2.2.1.3, 9.2.4.2.2
- 9.1.2** NASA-STD-3000A, 9.2.4.2.1
- 9.1.3** AFSC DH 1-3, DN2G4 1
- 9.1.4** NASA-STD-3000A, 9.2.3.2.6; MIL-STD-1472D, 5.4.1.3.6
- 9.1.5** NASA-STD-3000A, 9.2.3.2.6; MIL-STD-1472D, 5.4.1.3.6
- 9.1.6** NASA-STD-3000A, 9.2.2.2.1
- 9.1.7** NASA-STD-3000A, 9.2.2.2.1
- 9.1.8** NASA-STD-3000A, 9.2.5.2
- 9.1.9** FAA-STD-001B; FED-STD-595B; MIL-HDBK-759B, (draft), 5.5.2.1; MIL-STD-1472D, 5.7.9
- 9.2.1.1** NASA-STD-3000A, 9.2.2.2.2.a
- 9.2.1.2** MIL-STD-1472D, 5.9.4.7  
Note, see 6.7.2.2.5; MIL-HDBK-759B, (draft) 5.6.20.1; AFSC DH 1-3, 8.2.2.f
- 9.2.1.3** MIL-STD-1472D, 5.14.2.2.1, 5.14.3.3.3
- 9.2.1.4** MIL-HDBK-759B, (draft), 5.6.20.1; AFSC DH 1-3, 8.2.2 f
- 9.2.1.5**  
c. AFSC DH 1-3, 2G4, 2.3, 2.4
- 9.2.1.7** MIL-STD-1472D, 5.9.4.5; NASA-STD-3000A, 12.3.1.2.a
- 9.2.1.8** MIL-STD-1472D, 5.9.4.5, 5.9.4.6; NASA-STD-3000A, 12.3.1.2.a
- 9.2.1.9** AFSC DH 1-3, DN 2G4, 2.3
- 9.2.1.10** AFSC DH 1-3, DN 2G4, 2.3
- 9.2.1.11** AFSC DH 1-3, DN 2G4, 2.3
- 9.2.1.12** MIL-STD-1472D, 5.7.1.3; MIL-STD-1800A, 4.2.4.3
- 9.2.1.13** MIL-STD-1472D, 5.7.1.3.1
- 9.2.1.14** MIL-STD-1472D, 5.7.1.3.2; MIL-STD-1800A, Appendix 4.2.4.3, Requirement guidance
- 9.2.1.15** AFSC DH 1-3, DN 2G4 g; See 6.7.2.1.6
- 9.2.2.1.1** AFSC DH 1-3, DN 2G4 1.1, 1.2
- 9.2.2.1.2** AFSC DH 1-3, DN 2G4 1.2, 1.3
- E9.2.2.1.2** AFSC DH 1-3, DN 2G4 1.2, 1.3
- 9.2.2.1.3** AFSC DH 1-3, DN 2G4 1.2
- 9.2.2.2.1** MIL-STD-1472D, 5.7.1.1
- 9.2.2.3.1** MIL-STD-1800A, Appendix 4.2.4.4
- 9.2.2.3.2** MIL-STD-1800A, Appendix 4.2.4.4
- 9.2.2.3.3** MIL-STD-1800A, Appendix 4.2.4.4
- 9.2.2.3.4** MIL-STD-1800A, Appendix 4.2.4.4
- 9.2.2.4.1** MIL-STD-1472D, 5.7.1.3.4
- 9.3.1.1** MIL-HDBK-759B, 5.3.7.1
- E9.3.1.1** MIL-HDBK-759B, 5.3.7.1
- 9.3.1.2** MIL-HDBK-759B, 5.3.7.2
- 9.3.1.3** MIL-HDBK-759B, 5.14.3.6
- 9.3.1.4** NASA-STD-3000A, 8.7.2
- 9.3.2.1** New
- 9.3.2.4** New
- 9.3.2.5** HEGED, 1972 452; DOE, OSHA
- 9.3.2.6** NASA-STD-3000A, 8.7.2.3
- 9.3.2.7** HEGED 1972, 10.7 page 452, NASA-STD-3000A, 8.7.2.3
- 9.3.3.1.2** MIL-HDBK-759B, 5.3.10.1
- 9.3.3.1.3** MIL-HDBK-759B, 5.3.10.1
- 9.3.3.1.4** MIL-HDBK-759B, 5.3.10.1
- 9.3.3.1.5** MIL-HDBK-759B, 5.3.10.1, 5.3.10.3
- 9.3.3.2.1** MIL-HDBK-759B, 5.3.10.1
- 9.3.3.2.2** MIL-HDBK-759B, 5.3.10.2
- 9.3.3.3.1** MIL-STD-1472D, 5.7.7.6; MIL-STD-1800A, Appendix 4.2.7.7; MIL-W-5044, 5050
- 9.3.3.4.1** MIL-STD-1472D, 5.7.7.6
- 9.3.3.4.2** MIL-STD-1472D, 5.7.7.6
- 9.3.3.4.3** MIL-STD-1472D, 5.7.7.6; MIL-HDBK-759B, 5.3.11.2
- 9.3.3.4.4** MIL-STD-1472D, 5.7.7.6
- 9.3.3.4.5** MIL-HDBK-759B, 5.3.11.1
- 9.3.3.5.1** MIL-STD-1472D, 5.7.7.7; MIL-STD-1800A, Appendix 4.2.7.8
- 9.3.3.5.2** MIL-STD-1472D, 5.7.7.7
- 9.3.4.1.1** MIL-HDBK-759B, 5.3.5.1
- 9.3.4.2.1** MIL-STD-1800A, 4.2.8.1
- E9.3.4.2.1** MIL-HDBK-759B, 5.3.8.1
- 9.3.4.2.2** New
- 9.3.4.2.3** MIL-STD-1800A, 4.2.8.1
- 9.3.4.2.4** MIL-STD-1800A, 4.2.8.1
- 9.3.4.3.1** MIL-STD-1800A, Appendix 4, 2, 8.1; MIL-HDBK-759B, 5.3.8.3
- 9.3.4.3.2** MIL-STD-1800A, Appendix 4, 2, 8.1; MIL-HDBK-759B, 5.3.8.3
- 9.3.4.3.3** MIL-STD-1800A, Appendix 4, 2, 8.1; MIL-HDBK-759B, 5.3.8.3
- 9.3.4.3.4** MIL-STD-1800A, Appendix 4, 2, 8.1; MIL-HDBK-759B, 5.3.8.3
- 9.3.4.4.1** MIL-HDBK-759B, 5.3.5.2
- 9.3.4.4.2** MIL-STD-1472D, 5.13.4.1
- 9.3.4.5.1** MIL-STD-1800A, 4.2.8.2
- 9.3.4.5.2** MIL-STD-1800A, 4.2.8.2
- 9.3.4.5.3** MIL-STD-1800A, 4.2.8.2
- 9.3.4.5.4** MIL-STD-1800A, 4.2.8.2; MIL-STD-1472D, 5.7.8.2.3
- 9.3.4.5.5** MIL-STD-1472D, 5.7.8.2.3, 5.6.2.3
- 9.3.4.5.6** MIL-STD-1800A, 4.2.8.2
- 9.3.4.5.7** MIL-STD-1800A, 4.2.8.2
- 9.3.4.5.8** MIL-STD-1800A, 4.2.8.2
- 9.3.4.6.1** MIL-STD-1472D, 5.7.8.3; MIL-STD-1800A, 4.2.8.2
- E9.3.4.6.1** MIL-STD-1472D, 5.7.8.3; MIL-STD-1800A, 4.2.8.2
- 9.3.4.6.2** MIL-HDBK-759B, draft 5.3.9.4
- E9.3.5.1.1** MIL-STD-1800A, 4.2.7.1; MIL-STD-1472D, 5.7.7.1.1; MIL-HDBK-759B, 5.3.6.2; UCRL-15673, 2.4.3.2
- 9.3.5.1.3** MIL-HDBK-759B, 5.3.6.2
- Exceptions** MIL-STD-1472D, 5.7.7.1; MIL-HDBK-759B, 5.3.6.2
- 9.3.5.2.1** UCRL-15673, 2.4.3.3
- 9.3.5.2.2** UCRL-15673, 2.4.3.3
- 9.3.5.2.3** UCRL-15673, 2.4.3.3
- 9.3.5.2.4** UCRL-15673, 2.4.3.3

- 9.3.5.2.5** MIL-STD-1472D, 5.7.7.1.3  
**9.3.5.2.6** UCRL-15673, 2.4.3.3  
**9.3.5.3.1** UCRL-15673, 2.4.6  
**E9.3.5.3.1** UCRL-15673, 2.4.4.6  
**9.3.5.3.2** MIL-HDBK-759B, 5.3.5.1  
**9.3.5.3.3** MIL-HDBK-759B, 5.3.6.5.1  
**E9.3.5.3.3** MIL-HDBK-759B, 5.3.6.5.1  
**9.3.5.3.4** MIL-STD-1472D, 5.7.7.1.3  
**9.3.5.3.5** MIL-STD-1472D, 5.7.7.5.1; MIL-759B, 5.3.6.5.1  
**9.3.5.3.6** MIL-HDBK-759B, 5.3.6.5.1  
**9.3.5.4.1** UCRL-15673, 2.4.4.1  
**E9.3.5.4.1** UCRL-15673, 2.4.4.1; MIL-STD-1472D, 5.7.7.2; MIL-HDBK-759B, 5.3.6.4.2; MIL-STD-1800A, 4.2.7.4  
**9.3.5.4.2** MIL-HDBK-759B, 5.3.6.4  
**9.3.5.4.3** UCRL-15673, 2.4.4.1  
**9.3.5.4.4** UCRL-15673, 2.4.4.1  
**9.3.5.5.1** UCRL-15673, 2.4.4.2  
**E9.3.5.5.1** UCRL-15673, 2.4.4.2; MIL-STD-1472D, 5.7.7.3; MIL-HDBK-759B, 5.3.6.3.1; MIL-STD-1800A, 4.2.7.4  
**9.3.5.5.2** UCRL-15673, 2.4.4.2  
**9.3.5.5.3** UCRL-15673, 2.4.4.2  
**9.3.5.6.1** UCRL-15673, 2.4.4.2  
**E9.3.5.6.1** UCRL-15673, 2.4.4.3; MIL-STD-1472D, 5.7.7.4; MIL-HDBK-759B, 5.3.6.3.3; MIL-STD-1800A, 4.2.7.5  
**9.3.5.6.2** UCRL-15673, 2.4.4.3; MIL-STD-1800A, 4.2.7.5  
**E9.3.5.6.2** UCRL-15673, 2.4.4.3.d; MIL-HDBK-759B, 5.3.6.3.2  
**9.3.5.6.3** UCRL-15673, 2.4.4.3  
**9.3.5.6.4** MIL-STD-1472D, 5.7.7.5  
**9.3.5.7.1** UCRL-15673, 2.4.4; MIL-HDBK-759B, 5.3.6.3.7  
**E9.3.5.7.1**  
    **a.** UCRL-15673, 2.4.4.4; MIL-HDBK-759B, 5.3.6.3.2  
    **b.** UCRL-15673, 2.4.4.4  
**9.3.5.7.2** UCRL-15673, 2.4.4.4; MIL-HDBK-759B, 5.3.6.3.7  
**9.3.5.7.3** UCRL-15673, 2.4.4.4; MIL-HDBK-759B, 5.3.6.3.7  
**9.3.5.7.4** UCRL-15673, 2.4.4; MIL-HDBK-759B, 5.3.6.3.7  
**9.4.1** MIL-STD-1800A, 4.2.4.4; MIL-HDBK-759B, 5.3.15; MIL-STD-1472D, 5.7.4  
**E9.4.1** MIL-STD-1800A, 4.2.4.4; MIL-HDBK-759B, 5.3.15; MIL-STD-1472D, 5.7.4  
**9.4.2.1** New  
**9.4.2.2** MIL-HDBK-759B, 5.3.14  
**E9.4.2.2** MIL-HDBK-759B, 5.3.14  
**9.4.3.1** MIL-HDBK-759B, 5.3.13  
**E9.4.3.1** MIL-HDBK-759B, 5.3.13.3  
**9.4.4 f** MIL-HDBK-759B, 5.3.12.6  
**9.4.4.1** New  
**9.4.4.2** New  
**9.4.4.3** MIL-HDBK-759B, 5.3.12.6  
**9.4.4.4** MIL-HDBK-759B, 5.3.12.1; MIL-STD-1472D, 5.7.3.4.5  
**E9.4.4.4** MIL-HDBK-759B, 5.3.12.1  
**9.4.4.5** MIL-HDBK-759B, page 276  
**9.4.4.6** MIL-HDBK-759B, 5.3.12.2  
**9.4.4.7** MIL-HDBK-759B, 5.3.12.3; MIL-STD-1472D, 5.7.3.4.5  
**9.4.4.9** MIL-HDBK-759B, 5.3.12.4  
**9.4.4.10** MIL-HDBK-759B, 5.3.12.5  
**E9.4.4.10** MIL-HDBK-759B, 5.3.12.5  
**9.5.1.1** MIL-HDBK-759B, 5.2.3.1  
**E9.5.1.1**  
    **a.** MIL-STD-1800A, 4.2.5.1; MIL-STD-1472D, 5.7.5.1; MIL-HDBK-759B, 5.2.3.1.1  
**9.5.1.2** MIL-STD-1472D, 5.7.5.3  
**E9.5.2** MIL-STD-1800A, 4.2.5.2; MIL-STD-1472D, 5.7.6.1; MIL-HDBK-759B, 5.2.3.2.1  
**9.5.2.1** MIL-STD-1472D, 5.7.6.1.1  
**9.5.2.2** MIL-STD-1472D, 5.7.6.1.2  
**9.5.2.3** MIL-STD-1472D, 5.7.6.1.3  
**9.5.2.4** MIL-STD-1472D, 5.7.6.1.4  
**9.5.2.5** MIL-STD-1472D, 5.7.6.1.5  
**E9.5.3** MIL-STD-1800A, 4.2.5.3; MIL-STD-1472D, 5.7.6.2; MIL-HDBK-759B, 5.2.3.2.2  
**9.5.3.1** MIL-STD-1472D, 5.7.6.2.1  
**9.5.3.2** MIL-STD-1472D, 5.7.6.2.2  
**9.5.4.1** New  
    **q.** EPRI NP-3659  
**E9.5.4.1** EPRI NP-3659, PP. 65, 66, 78  
**E9.5.4.2** EPRI NP-3659, P. 69  
**E9.5.4.4** EPRI NP-3659, PP. 81, 82  
**9.5.4.5** EPRI NP-3659, p. 83 and 85  
**9.6.1** ANSI/HFS 100-1988  
**9.7.1** ADAAG Appendix B and Appendix C  
**9.7.2** ADAAG Appendix A 4.1.4  
**9.7.3** New  
**10** SMEs 18, 19, 24, 26, 27  
**10.1.1.1** AFHRL-TR-73-4310-33(I),3.2.7  
    FAA-D-2492/b, 3.1.1  
**10.1.1.2** FAA-D-2494/b, 3.1.1, MIL-M-GCSFUI, 3.3.2.2  
**10.1.2.1** Angiolillo and Roberts, 1991; Simpson and Casey, p. 178-179  
**10.1.2.2** Angiolillo and Roberts, 1991  
**10.1.2.3** FAA-D-2494/b, 3.6.6; Angiolillo and Roberts, 1991; Simpson and Casey, p. 176  
**10.1.2.4** Angiolillo and Roberts, 1991  
**10.1.2.5** New, SME  
**10.2.1.1.1** FAA-D-2494/b, 3.1.5(d); MIL-STD-962B, 5.3.1.1; New  
**10.2.1.1.2** FAA-D-2494/b, 3.3.1.2.3; MIL-STD-962B, 4.3.10.2; MIL-STD-490A, 3.2.5  
**10.2.1.1.3** New  
**10.2.1.1.4** FAA-D-2494/b, 3.1.5(d); MIL-STD-490A, 3.2.5  
**10.2.1.2.1** FAA-D-2494/b, 3.3.1.2.2; MIL-STD-490A, 3.2.4  
**10.2.1.2.2** MIL-STD-962B, 4.3.10.1; MIL-STD-490A, 3.2.4  
**10.2.1.2.3** MIL-STD-962B, 4.3.10.1; MIL-STD-490A, 3.2.4

- 10.2.1.3.1** MIL-STD-962B, 4.3.10.1; MIL-STD-490A, 3.2.4
- 10.2.1.4.1** MIL-STD-490A, 3.2.7; Simpson and Casey, p. 157
- 10.2.1.4.2** MIL-STD-490A, 3.2.7; MIL-STD-962B, 4.4; Zaneski, p. 72
- 10.2.1.5.1** Simpson and Casey, pp. 149-156
- 10.2.1.5.2** Gribbons, p. 61
- 10.2.2.1** MIL-M-GCSFUI, 3.3.3.d, 3.3.3.e
- 10.2.2.2** New
- 10.2.2.3** Spyridakis and Wenger, pp. 208-209
- 10.2.2.4** MIL-M-GCSFUI, 3.3.3.d, 3.3.3.e
- 10.2.3** Simpson and Casey, p. 194
- 10.2.3.1.1** FAA-D-2494/b, 3.1.1, 3.1.5(c); MIL-STD-490A, 3.2.3; MIL-STD-962B, 4.3.2
- 10.2.3.1.2** FAA-D-2494/b, 3.1.5(b)
- 10.2.3.1.3** New
- 10.2.3.2.1** FAA-D-2494/b, A-1 3(a), Boff and Lincoln, 8.129
- 10.2.3.3.1** MIL-M-GCSFUI, 3.3.3.d, 3.3.3.e
- 10.2.3.4.1** MIL-M-GCSFUI, 3.3.3.d, 3.3.3.e
- 10.2.3.4.2** MIL-STD-490A, 3.2.3; Hartley (1978), p. 59
- 10.2.3.4.3** Lund, personal communication, 2.2.3.3
- 10.2.3.5.1** AFHRL-TR-73-43(I), 3.3.7.3.b
- 10.2.3.5.2** Lund, personal communications, 2.2.3.2; Spyridakis and Wenger, p. 207
- 10.2.3.5.3** Lund, personal communications, 2.2.3.3
- 10.2.3.6.1** FAA-D-2494/b, 3.1.2; MIL-HDBK-761A, 5.4.1.3.b; Simpson and Casey, p. 196; Spyridakis and Wenger, p. 205
- 10.2.3.7.1** AFHRL-TR-73-43(I), 3.3.7.3.a; FAA-D-2494/b, 3.1.2
- 10.2.3.7.2** AFHRL-TR-73-43(I), 3.3.7.3.a; FAA-D-2494/b, 3.1.2
- 10.2.3.8.1** Hartley (1978), p. 60; Simpson and Casey, p. 197; Spyridakis and Wenger, p. 205
- 10.2.3.8.2** Hartley (1978), p. 60
- 10.2.3.9.1** MIL-STD-490A, 3.2.3.5(a); MIL-STD-962B, 4.3.6(a)
- 10.2.3.9.2** AFHRL-TR-73-43(I), 3.3.7.3.g
- 10.2.3.10.1** MIL-STD-490A, 3.2.3.1; MIL-STD-962B, 4.3.3
- 10.2.3.10.2** MIL-STD-490A, 3.2.6
- 10.2.3.10.3** MIL-STD-490A, 3.2.3.1; MIL-STD-962B, 4.3.3; FAA-D-2494/b, 3.1.5
- 10.2.3.10.4** New
- 10.2.4.1.1** FAA-D-2494/b, 3.1.4; MIL-STD-490A, 3.2.3; Simpson and Casey, p. 195, SME
- 10.2.4.2** Spyridakis and Wenger, p. 204
- 10.2.4.2.1** Spyridakis and Wenger, p. 204
- 10.2.4.2.2** Spyridakis and Wenger, p. 204
- 10.2.4.2.3** Spyridakis and Wenger, p. 204
- 10.2.4.3.1** Spyridakis and Wenger, p. 205; Hartley (1978), p. 60
- 10.2.4.3.2** FAA-D-2494/b, 3.1.5.c
- 10.2.4.3.3** MIL-STD-962B, 4.3.6(k)
- 10.2.4.3.4** MIL-STD-490A, 3.2.3.7; MIL-STD-962B, 4.3.6(l)
- 10.2.4.4.1** AFSC DH 1-3, DN 6B13, 1
- 10.2.4.5.1** MIL-M-GCSFUI, 3.3.3.c; New
- 10.2.4.5.2** FAA-D-2494/b, 3.1.3; MIL-STD-490A, 3.2.3.6; MIL-STD-962B, 4.3.6(h), 4.3.6(i), 4.3.6(j)
- 10.2.4.6.1** FAA-D-2494/b, 3.1.5(e)
- 10.2.4.7.1** National Computing Center, 6.1.3.6, SME
- 10.2.4.7.2** FAA Order 1700.8D, Appendix 1, 8.e(7)
- 10.2.4.7.3** New
- 10.2.4.7.4** New
- 10.2.4.8** Simpson and Casey, p. 195
- 10.2.4.8.1** FAA-D-2494/b, 3.1.5, 3.4.10
- 10.2.4.8.2** FAA-D-2494/b, 3.1.5, 3.4.10
- 10.2.4.8.3** New
- 10.2.4.8.4** FAA-D-2494/b, 4.3.10
- 10.2.4.8.5** FAA-D-2494/b, 3.1.5; FAA Order 1700.8D, Appendix 1, 8.i(5)
- a.** FAA Order 1000.15A, glossary
- b.** FAA Order 17340.1H, Contractions
- 10.2.4.8.6** MIL-STD-962B, 3.4.3
- 10.2.4.8.7** FAA Order 1700.8D, Appendix 1, 9.1(6)
- 10.2.4.8.8** MIL-STD-962B, 4.3.6(k)
- 10.2.4.9.1** FAA-D-2494/b, 3.1.5; MIL-STD-490A, 3.2.3.1; MIL-STD-962B, 4.3.3
- 10.2.4.10.1** FAA-D-2494/b, 3.1.5; USGPO Style Manual, pp. 168-169
- 10.2.4.10.2** USGPO Style Manual, p. 165; Lund, personal communication, 2.2.2.4
- 10.2.4.10.3** MIL-STD-962B, 4.3.7
- 10.2.4.10.4** USGPO Style Manual, p. 167
- 10.2.4.11.1** FAA Order 1700.8D, Appendix 1, 9.a(6)
- 10.2.4.11.2** MIL-STD-962B, 4.3.8.1
- 10.2.4.12.1** FAA-D-2494/b, 3.4.2; FAA-D-2494/b, 3.4.3
- 10.2.4.13.1** FAA-D-2494/b, 3.4.4
- 10.2.4.13.2** FAA-D-2494/b, 3.4.5
- 10.2.4.13.3** FAA-D-2494/b, 3.4.7
- 10.2.4.14.1** FAA-D-2494/b, 3.4.6
- 10.2.4.14.2** FAA-D-2494/b, 3.4.9
- 10.3.1.1.1** FAA-D-2494/b, 5.3.1
- 10.3.1.1.2** New
- 10.3.1.1.3** Simpson and Casey, p. 174
- 10.3.1.2.1** Simpson and Casey, p. 173
- 10.3.1.2.2** Simpson and Casey, p. 173
- 10.3.1.2.3** Simpson and Casey, p. 172
- 10.3.2.1.1** Houghton-Alico, p. 59
- 10.3.2.1.2** FAA-D-2494/b, 3.3.1.2; FAA Order 1700.8D, Appendix 1, 9.a(5); Simpson and Casey, p. 183
- 10.3.2.1.3** New
- E10.3.2.1.3** New
- 10.3.2.1.4** Simpson and Casey, p. 183; New
- 10.3.2.2.1** New
- 10.3.2.2.2** Simpson and Casey, p. 183
- 10.3.2.2.3** Simpson and Casey, p. 183; Houghton-Alico, p. 60; New
- 10.3.2.2.4** FAA-D-2494/b, Figure 2
- 10.3.2.3** Gribbons, p. 72; Hartley
- 10.3.2.3.1** Gribbons, p. 72

- 10.3.2.3.2** Gribbons, p. 71
- 10.3.2.4.1** New
- 10.3.2.5.1** FAA-D-2494/b, 3.3.1.2.4
- 10.3.2.5.2** FAA-D-2494/b, 3.3.1.2.4
- 10.3.2.6.1** FAA-D-2494/b, 3.3.1.2.4; MIL-STD-962B, 4.3.11
- 10.3.2.6.2** FAA Order 1700.8D, Appendix 1, 9.a(7)(a); Simpson and Casey, p. 170
- 10.3.2.6.3** FAA Order 1700.8D, Appendix 1, 9.a(7)(a); FAA-D-2494/b, 3.3.1.2.4; MIL-STD-962B, 4.3.11
- 10.3.2.6.4** FAA Order 1700.8D, Appendix 1, 9.a(7)(c)
- 10.3.2.6.5** FAA-D-2494/b, 3.3.1.2.4
- 10.3.2.7.1** FAA Order 1700.8D, Appendix 1, 9.a(2)(a)
- 10.3.2.7.2** New
- 10.3.2.8.1** MIL-STD-490A, 3.2.10; MIL-STD-962B, 4.3.15
- 10.3.2.8.2** FAA Order 1700.8D, Appendix 1, 8.g(5)(a)
- 10.3.2.8.3** New
- 10.3.2.8.4** FAA Order 1700.8D, Appendix 1, 8.g(5)(c)
- 10.3.2.8.5** FAA Order 1700.8D, Appendix 1, 8.g(5)(e)
- 10.3.2.8.6** FAA Order 1700.8D, Appendix 1, 8.g(5)(b); MIL-STD-490A, 3.2.10; MIL-STD-962B, 4.3.15
- 10.3.2.8.7** New
- 10.3.3.1.1** FAA Order 1700.8D, Appendix 1, 9.a(1); FAA-D-2494/b, 3.3.1.2.1; Zaneski, p. 37
- 10.3.3.1.2** FAA-D-2494/b, 3.3.1.2.1
- 10.3.3.1.3** Spyridakis and Williams, p. 68; Gribbons p. 68
- 10.3.3.2** Simpson and Casey, p. 191
- 10.3.3.2.1** Simpson and Casey, pp. 190-191
- 10.3.3.3.1** Simpson and Casey, p. 190
- 10.3.3.4.1** Simpson and Casey, p. 182
- 10.3.3.4.2** Simpson and Casey, pp. 181-182
- 10.3.3.4.3** Smith, S., 1992 private communication
- 10.3.3.5** Cooper, Daghish, and Adams, p. 66; Simpson and Casey, pp. 188-189
- 10.3.3.5.1** Simpson and Casey, p. 189
- 10.3.3.5.2** Simpson and Casey, pp. 189
- 10.3.3.6** Gribbons, p. 70; Simpson and Casey, pp. 185-186
- 10.3.3.6.1** New
- 10.3.3.6.2** AFHRL-TR-73-43(I), 3.3.7.3.h; FAA-D-2494/b, 3.1.6
- 10.3.3.6.3** MIL-STD-962B, 4.3.9; Hartley p. 27; Lund, personal communication, 2.2.2.1
- 10.3.3.7** Simpson and Casey, pp. 191-193
- 10.3.3.7.1** Simpson and Casey, p. 192
- 10.3.3.7.2** Hartley, (1978), p. 27; Simpson and Casey, p. 193; Zaneski, p. 37
- 10.3.3.7.3** Hartley, (1978), p. 27; Simpson and Casey, p. 193
- 10.3.3.7.4** FAA-D-2494/b, 3.1.5(a); MIL-STD-490A, 3.2.6; MIL-STD-962B, 4.3.9; Gribbons, p. 70; Hartley, p. 27; Simpson and Casey, p. 192
- 10.3.3.7.5** Hartley, 1978, p. 27; Lund, personal communication, 2.2.2.2
- 10.3.3.7.6** MIL-STD-490A, 3.2.6; Simpson and Casey, pp. 191-193
- 10.3.3.8** Simpson and Casey, p. 191
- 10.3.3.8.1** Simpson and Casey, p. 180
- 10.3.3.9** Gribbons, p. 70
- 10.3.3.9.1** Gribbons, p. 70
- 10.3.3.9.2** New; Gribbons, p. 70
- 10.3.3.9.3** Hartley, 1978, p. 47
- 10.4.1.1** E10.4 New; FAA Order 1320.D;1320.58; FAA-D-2494/b Appendix 1; FAA-D-2494/b, 3.6, Table 1
- 10.4.1.1** FAA-D-2494/b, 3.6.1.1
- 10.4.1.2** FAA-D-2494/b, 3.6.1
- 10.4.1.3** New
- 10.4.1.4** New
- 10.4.2.1** FAA-D-2494/b, 3.6.6; Angiolillo and Roberts, 1991; Simpson and Casey, p. 176
- 10.4.2.2** MIL-STD-962B, 5.5
- 10.4.2.3** FAA-D-2494/b, 3.6.6; MIL-STD-962B, 5.5
- 10.4.2.4** FAA-D-2494/b, 3.6.6
- 10.4.3.1** FAA-D-2494/b, 3.6.7
- 10.4.3.2** FAA-D-2494/b, 3.6.8
- 10.4.3.3** Simpson and Casey, p. 185
- 10.4.4.1.1** FAA Order 1700.8D, Appendix 1, 8.g(1)
- 10.4.4.1.2** MIL-STD-490A, 3.2.8; Simpson and Casey, p. 185
- 10.4.4.2.1** FAA Order 1700.8D, Appendix 1, 8.g(1), 8.g(6); FAA-D-2494/b, 3.6.20.3; MIL-STD-490A, 3.2.8.2; MIL-STD-962B, 4.3.13.1; Simpson and Casey, p. 185; Zaneski, p. 33
- 10.4.4.2.2** FAA-D-2494/b, 3.6.20.3
- 10.4.4.3.1** New
- 10.4.4.3.2** FAA Order 1700.8D, Appendix 1, 8.g(2); MIL-STD-490A, 3.2.8.1; MIL-STD-962B, 4.3.13; Simpson and Casey, pp. 185, 214
- 10.4.4.3.3** FAA Order 1700.8D, Appendix 1, 8.i(2); MIL-STD-490A, 3.2.9.1
- 10.4.4.4.1** Simpson and Casey, p. 215; FAA Order 1700.8D, Appendix 1, 8.g(1)
- 10.4.4.4.2** AFHRL-TR-73-43(I), 3.3.7.4
- 10.4.4.4.3** Simpson and Casey, p. 215
- 10.4.4.4.4** FAA Order 1700.8D, Appendix 1, 8.g(1); Simpson and Casey, p. 212
- 10.4.4.4.5** FAA-D-2494/b, 3.6.20.2
- 10.4.4.4.6** FAA-D-2494/b, 3.6.20.2
- 10.4.4.4.7** FAA Order 1700.8D, Appendix 1, 8.g(4)
- 10.4.4.5.1** AFHRL-TR-73-43(I), 3.3.7.4.d
- 10.4.4.5.2** AFHRL-TR-73-43(I), 3.3.7.4.k, 3.3.7.4.j; FAA Order 1700.8D, Appendix 1, 8.g(3)
- 10.4.4.5.3** FAA-D-2494/b



- 10.4.4.6.1** FAA Order 1700.8D, Appendix 1, 8.g(2); MIL-STD-962B, 4.3.13
- 10.4.4.6.2** FAA Order 1700.8D, Appendix 1, 8.g(2); MIL-STD-962B, 4.3.13
- 10.4.4.7.1** FAA Order 1700.8D, Appendix 1, 8.g(5); MIL-STD-962B, 4.3.13.2
- 10.4.4.7.2** MIL-STD-962B, 4.3.13.2
- 10.4.4.7.3** FAA-D-2494/b, 3.6.20.4
- 10.4.5.1.1** FAA Order 1700.8D, Appendix 1, 8.i(1); MIL-STD-490A, 3.2.9; MIL-STD-962B, 4.3.12; FAA-D-2494/b, 3.1.7.1
- 10.4.5.2.1** FAA-D-2494/b, 3.1.7.4; FAA Order 1700.8D, Appendix 1, 8.i(4); MIL-STD-490A, 2.9.2; MIL-STD-962B, 4.3.12.1
- 10.4.5.2.2** FAA-D-2494/b, 3.1.7.4
- 10.4.5.3.1** New
- 10.4.5.3.2** FAA Order 1700.8D, Appendix 1, 8.i(2)
- 10.4.5.3.3** FAA Order 1700.8D, Appendix 1, 8.i(2); MIL-STD-490A, 3.2.9.1
- 10.4.5.4.1** FAA Order 1700.8D, Appendix 1, 8.i(1); MIL-STD-490A, 3.2.9.2
- 10.4.5.4.2** FAA Order 1700.8D, Appendix 1, 8.i(1); FAA-D-2494/b, 3.1.7.3
- 10.4.5.4.3** New
- 10.4.5.4.4** FAA Order 1700.8D, Appendix 1, 8.i(3)
- 10.4.5.4.5** FAA-D-2494/b, 3.1.7.3; Simpson and Casey, p. 217
- 10.4.5.5.1** FAA-D-2494/b, 3.1.7; MIL-STD-490A, 3.2.9; MIL-STD-962B, 4.3.12
- 10.4.5.5.2** MIL-STD-490A, 3.2.9, 3.2.9.2; MIL-STD-962B, 4.3.12
- 10.4.5.6.1** FAA Order 1700.8D, Appendix 1, 8.i(2)
- 10.4.5.6.2** FAA Order 1700.8D, Appendix 1, 8.i(2); MIL-STD-490A, 3.2.9.2; MIL-STD-962B, 4.3.12.2
- 10.4.5.7.1** FAA Order 1700.8D, Appendix 1, 8.g(5); MIL-STD-962B, 4.3.13.2
- 10.4.5.7.2** MIL-STD-962B, 4.3.12.3
- 10.4.5.7.3** FAA-D-2494/b, 3.6.20.4
- 10.4.6.1** New
- 10.4.6.2** New
- 10.4.6.3** Rubens, 14.59
- 10.4.6.4** New
- 10.4.6.5** Rubens, 3.51
- 10.4.7.1** FAA Order 1700.8D, Appendix 1, 8.h(3)
- 10.4.7.2** FAA Order 1700.8D, Appendix 1, 8.h(2)
- 10.4.7.3** FAA Order 1700.8D, Appendix 1, 8.h(1)
- 10.4.8.1** FAA-D-2494/b, 3.1.6
- 10.4.8.2** FAA-D-2494/b, 3.1.6; MIL-M-GCSFUI, 3.2.2.4
- 10.4.8.3** FAA-D-2494/b, 3.1.6; MIL-M-GCSFUI, 3.2.2.4
- 10.4.8.4** FAA-D-2494/b, 3.1.6; MIL-M-GCSFUI, 3.2.2.4
- 10.4.8.5** FAA-D-2494/b, 3.1.6; MIL-M-GCSFUI, 3.2.2.4
- 10.4.8.6** FAA-D-2494/b, 3.1.6; MIL-M-GCSFUI, 3.2.2.4
- 10.4.9.1** FAA Order 1700.8D, Appendix 1, 8.f
- 10.4.9.2** FAA Order 1700.8D, Appendix 1, 8.f; MIL-STD-962B, 5.13
- 10.4.9.3** FAA Order 1700.8D, Appendix 1, 8.f; MIL-STD-962B, 5.13.1
- 10.4.9.4** New
- 10.4.9.5** FAA Order 1700.8D, Appendix 1, 9.a(7)(c)
- 10.4.9.6** FAA Order 1700.8D, Appendix 1, 8.f
- 10.4.10.1** FAA Order 1700.8D, Appendix 1, 8.e(7)
- 10.4.10.2** Zaneski, p. 28
- 10.4.10.3** New
- 10.4.11.1** FAA Order 1700.8D, Appendix 1, 8.e(8)
- 10.4.11.2** FAA Order 1700.8D, Appendix 1, 8.e(8); Zaneski, pp. 28-29
- 10.4.11.3** Simpson and Casey, p. 177
- 10.4.11.4** MIL-STD-962B, 5.14
- 10.4.12.1** FAA-D-2494/b, 3.3.2.3
- 10.4.12.2** FAA-D-2494/b, 3.3.2.3
- 10.4.12.3** FAA-D-2494/b, 3.3.2.3; MIL-STD-962B, 5.15
- 10.4.12.4** FAA-D-2494/b, 3.3.2.3
- 10.4.13.1** Simpson and Casey, pp. 178-179
- 10.4.14.1** MIL-STD-490A, 3.2.11.1; MIL-STD-962B, 4.3.13.1; Hartley, (1978), p. 61
- 10.4.14.2** MIL-STD-962B, 4.3.14.1
- 10.4.14.3** MIL-STD-490A, 3.2.11.1; MIL-STD-962B, 4.3.14.1
- 10.4.14.4** New
- 10.4.15.1** Zaneski, p. 25
- 10.4.15.2** MIL-STD-962B, 4.2.5
- 10.4.16.1** FAA-D-2494/b, 3.3.2.1.3
- 10.5.1.1.1** MIL-M-87268, 3.6.1.2
- 10.5.1.1.2** Wierenga, D., Moore C., & Barnes V., 8.2
- 10.5.1.1.3** AFSC DH 1-3, DN 6B134,5; MIL-M-87268, 3.6.1.1
- 10.5.1.1.4** MIL-M-87268, 3.6.1.4.3
- 10.5.1.1.5** MIL-M-87268, 3.6.1.4.2.8
- 10.5.1.2.1** Wierenga, D., Moore C., & Barnes V., 14.1
- 10.5.1.2.2** Wierenga, D., Moore C., & Barnes V., 14.4
- 10.5.1.2.3** MIL-M-87268, 3.6.1.3.1
- 10.5.1.2.4** Wierenga, D., Moore C., & Barnes V., 14.1
- 10.5.1.2.5** MIL-M-87268, 3.6.1.3.3; Wierenga, D., Moore C., & Barnes V., 14.2
- 10.5.1.2.6** MIL-M-87268, 3.6.1.4.2
- 10.5.1.2.7** Wierenga, D., Moore C., & Barnes V., 14.3
- 10.5.1.3.1** MIL-M-38784, 3.2.9.5.3
- 10.5.1.3.2** Wierenga, D., Moore C., & Barnes V., 12.1
- 10.5.1.3.3** Wierenga, D., Moore C., & Barnes V., 16.1
- 10.5.1.3.4** AFSC DH 1-3, DN 6B13,5
- 10.5.1.5.1** AFSC DH 1-3, DN 6B13,3
- 10.5.1.5.2** Wierenga, D., Moore C., & Barnes V., 5.1
- 10.5.1.5.4** MIL-M-87268, 3.6.1.5.1

- 10.5.1.5.8** MIL-M-87268, 3.6.1.5.3  
**10.5.1.5.9** Wierenga, D., Moore C., & Barnes V., 17.1  
**10.5.1.5.10** Wierenga, D., Moore C., & Barnes V., 9.5  
**10.5.1.5.11** Wierenga, D., Moore C., & Barnes V., 9.3  
**10.5.1.5.12** Wierenga, D., Moore C., & Barnes V., 9.4  
**10.5.1.7.1** Wierenga, D., Moore C., & Barnes V., 19.2  
**10.5.1.7.2** Wierenga, D., Moore C., & Barnes V., 19.1  
**10.5.1.7.3** Wierenga, D., Moore C., & Barnes V., 19.3  
**10.5.1.8.1** MIL-M-87268, 3.6.1.5.2  
**10.5.1.8.2** Wierenga, D., Moore C., & Barnes V., 20.4  
**10.5.1.8.3** Wierenga, D., Moore C., & Barnes V., 20.1  
**10.5.1.8.4** Wierenga, D., Moore C., & Barnes V., 20.2  
**10.5.1.8.5** Wierenga, D., Moore C., & Barnes V., 20.3  
**10.5.1.8.6** Wierenga, D., Moore C., & Barnes V., 20.5  
**10.5.1.8.7** MIL-M-87268, 3.6.1.5.5  
**10.5.2.1.2** MIL-M-87268, 3.2.1.4  
**10.5.2.1.3** MIL-M-87268, 3.2.1, 3.5.2.2.7  
**10.5.2.1.4** MIL-M-87268, 3.2.2.1  
**10.5.2.2.1** MIL-M-87268, 3.1.6  
**10.5.2.2.2** MIL-M-87268, 3.3.2  
**10.5.2.2.3** MIL-M-87268, 3.3.1  
**10.5.2.2.4** MIL-M-87268, 3.3.2  
**10.5.2.3.2** MIL-M-87268, 3.3.5  
**10.5.2.3.3** MIL-M-87268, 3.3.5.1, 3.4.2.2.2, 3.4.2.2.5, 3.4.2.2.6, 3.4.2.2.4  
**10.5.2.3.4** MIL-M-87268, 3.3.5.5, 3.3.5.11  
**10.5.2.3.5** MIL-M-87268, 3.3.5.7  
**10.5.2.3.6** MIL-M-87268, 3.3.5.8  
**10.5.2.3.7** MIL-M-87268, 3.3.5.9  
**10.5.2.3.8** MIL-M-87268, 3.3.5.15  
**10.5.2.3.9** MIL-M-87268, 3.3.5.12  
**10.5.2.3.10** MIL-M-87268, 3.3.5.13  
**10.5.2.3.11** MIL-M-87268, 3.3.5.14  
**10.5.2.3.12** MIL-M-87268, 3.3.5.14.1  
**10.5.2.3.13** MIL-M-87268, 3.3.5.14.2  
**10.5.2.3.14** MIL-M-87268, 3.3.5.14.3  
**10.5.2.3.15** MIL-M-87268, 3.3.5.16  
**10.5.2.3.16** MIL-M-87268, 3.4.2.6, 3.4.2.7  
**10.5.2.4.1** MIL-M-87268, 3.3.6  
**10.5.2.4.2** MIL-M-87268, 3.3.6.1  
**10.5.2.4.3** MIL-M-87268, 3.3.6.2  
**10.5.2.4.4** MIL-M-87268, 3.4.2.5  
**10.5.2.4.5** MIL-M-87268, 3.3.6.2.1, 3.3.6.2.2  
**10.5.2.4.6** MIL-M-87268, 3.3.6.2.3  
**10.5.2.5.1** MIL-M-87268, 3.2.2, 3.2.4  
**10.5.2.5.2** MIL-M-87268, 3.2.2.d, 3.2.3  
**10.5.2.5.3** MIL-M-87268, 3.2.2.4.a  
**10.5.2.5.4** MIL-M-87268, 3.5.1.6  
**10.5.2.5.5** MIL-M-87268, 3.5.1.6.1  
**10.5.2.5.6** MIL-M-87268, 3.5.1.6.2, 3.5.1.6.5  
**10.5.2.5.7** MIL-M-87268, 3.2.2.3  
**10.5.2.5.8** MIL-M-87268, 3.2.2.4.b  
**10.5.2.6.1** MIL-M-87268, 3.4.1.4  
**10.5.2.6.2** MIL-M-87268, 3.1.4, 3.4.2.4  
**10.5.2.6.3** MIL-M-87268, 3.4.2.4.1  
**10.5.2.6.4** MIL-M-87268, 3.4.2.4.2  
**10.5.2.6.6**  
**a.** MIL-M-87268, 3.5.2.1.1  
**b.** MIL-M-87268, 3.5.2.1.2  
**c.** MIL-M-87268, 3.5.2.1.4  
**d.** MIL-M-87268, 3.5.2.1.3  
**10.5.2.6.7** MIL-M-87268, 3.5.2.2  
**a.** MIL-M-87268, 3.5.2.2.1  
**b.** MIL-M-87268, 3.5.2.2.2  
**c.** MIL-M-87268, 3.5.2.2.3  
**d.** MIL-M-87268, 3.5.2.2.4  
**f.** MIL-M-87268, 3.5.2.2.6  
**10.5.2.7.3** MIL-M-87268, 3.4.1  
**10.5.2.8.1** MIL-M-87268, 3.6.1, 3.6.1.1  
**10.5.2.9.1** MIL-M-87268, 3.6.2  
**10.5.2.9.2** MIL-M-87268, 3.6.2.1  
**10.5.2.9.3** MIL-M-87268, 3.6.2.2  
**10.5.2.9.4** MIL-M-87268, 3.6.2.3  
**10.5.2.9.5** MIL-M-87268, 3.6.2.4  
**10.5.2.9.6** MIL-M-87268, 3.6.2.5  
**10.5.2.9.7** MIL-M-87268, 3.6.2.6  
**10.5.2.10.1** MIL-M-87268, 3.6.3  
**10.5.2.10.2** MIL-M-87268, 3.6.3.1  
**10.5.2.10.3** MIL-M-87268, 3.6.3.2  
**10.5.2.11.1** MIL-M-87268, 3.6.4  
**10.5.2.11.2** MIL-M-87268, 3.6.4  
**10.6.1** Scadden & Vanderheiden, 1988, M-1, p. 48  
**10.6.2** Ladner, 1988, p. 220  
**10.6.3** Vanderheiden & Vanderheiden, 1991, D-1, pp. 76-77  
**10.6.4** Vanderheiden & Vanderheiden, 1991, D-2, p. 78  
**11** 20 a, 20 b, 24, 25, 31, 33, 34, 35  
**11.1.1** New  
**11.1.2** New  
**11.1.3** New  
**11.1.4** FAA Order 1600.54B,  
**11.1.5** MIL-H-46855B, 3.1.1.c  
**11.1.6** New  
**11.1.7** New  
**11.1.8** SME #20  
**11.1.9** New  
**11.2** Systems Specification for Communications System Segment, p. 59  
**11.2.1** New  
**11.2.2** New  
**11.2.3** Computer Security p. 83  
**11.2.4** SME #20  
**11.2.5** Computer Security p. 84  
**11.3.1.1** New  
**11.3.1.2** ESD-TR-86-278, 6.1.1  
**11.3.1.3** ESD-TR-86-278, 4.0.3  
**11.3.1.4** ESD-TR-86-278, 6.1.2, 4.1.2  
**11.3.1.5** ESD-TR-86-278, 4.1.3  
**11.3.1.6** ESD-TR-86-278, 6.1.6  
**11.3.1.7** New  
**11.3.1.8** New  
**11.3.1.9** ESD-TR-86-278, 6.1.8  
**11.3.1.10** New  
**11.3.1.11** New  
**11.3.1.12** New

- 11.3.1.13** ESD-TR-86-278, 6.1.8  
**11.3.1.14** New  
**11.3.2** FAA Order 1600.54B, 406; CSC-STD-002-85  
**11.3.2.1** ESD-TR-86-278, 6.1.4; CSC-STD-002-85  
**11.3.2.2** New  
**11.3.2.3** MIL-HDBK-761A, 5.7.2.2.d  
**11.3.2.4** CSC-STD-002-85,  
**11.3.2.5** New  
**11.3.3** New  
**11.4.1** New  
**11.4.2** New  
**11.4.3** New  
**11.4.4** DOD 5200.28-STD, 3.1.2.2  
**11.5.1.1** ESD-TR-86-278, 6.0.1  
**11.5.1.2** System Specification for Communication System Segment, p. 59  
**11.5.1.3** ESD-TR-86-278, 6.0.2  
**11.5.1.4** MIL-HDBK-761A, 5.7.3.3.b; ESD-TR-86-278, 6.2.3  
**11.5.1.5** System Specification for Communication System Segment, p. 104  
**11.5.2** FAA Order 1600.54B, 504.b  
**11.5.2.1** New  
**11.5.2.2** ESD-TR-86-278, 6.4.3; MIL-HDBK-761A, 5.7.3.1.d  
**11.5.3.1** ESD-TR-86-278, 6.2.8; MIL-HDBK-761A, 5.7.3.2.a  
**11.5.3.2** MIL-HDBK-761A, 5.7.3.2.d  
**11.5.4.1** ESD-TR-86-278, 6.4.1  
**11.5.4.2** MIL-HDBK-761A, 5.7.4.2  
**11.5.4.3** MIL-HDBK-761A, 5.7.4.2.a  
**11.6.1** FAA Order 1600.54B, 804.d.1  
**11.6.2** FAA Order 1600.54B, 804.d.4  
  
**12** SMEs 21a, 21b, 22, 24, 33  
  
**12.1.1** MIL-STD-1472D, 5.13.1;  
**12.2.1.1** MIL-STD-1472D, 5.13.4.1; DOE-STAND HFAC 1, 10.4.1  
**12.2.1.2** MIL-STD-1472D, 5.13.4.1; DOE-STAND HFAC 1, 10.4.1  
**12.2.1.3** MIL-STD-1472D, 5.13.4.1; DOE-STAND HFAC 1, 10.4.1  
**12.2.1.4** MIL-HDBK-759B, 5.7.2.1.2.3  
**12.2.1.5** MIL-STD-1472D, 5.13.4.4; DOE-STAND HFAC 1, 10.4.4  
**12.2.1.6** MIL-STD-1472D, 5.13.4.1; DOE-STAND HFAC 1, 10.4.2  
**12.2.1.7** MIL-STD-1472D, 5.13.4.3; DOE-STAND HFAC 1, 10.4.3  
**12.2.1.8** MIL-STD-1472D, 5.13.4.5; DOE-STAND HFAC 1, 10.4.5  
**12.2.2.1** MIL-STD-1472D, 5.13.6.1; MIL-HDBK-759B, 5.7.3.6.1  
**12.2.2.2** HDBK-759B, 5.7.3.6.1  
**12.2.2.3** MIL-STD-1472D, 5.13.6.2  
**12.2.2.4** MIL-STD-1472D, 5.7.7.6  
**12.2.2.5** MIL-STD-1472D, 5.13.6.3  
**12.2.2.6** MIL-STD-1472D, 5.13.7.2.2  
**12.2.2.7** MIL-HDBK-759B, 5.7.3.6  
**12.2.2.8** MIL-STD-1472D, 5.7.7.6  
**12.2.2.9** MIL-HDBK-759B, 5.7.3.6  
**12.2.2.10** MIL-HDBK-759B, 5.7.3.6  
  
**12.3.1** MIL-STD-1472D, 5.13.5.1; DOE-STAND HFAC 1, 10.6.1  
**12.3.1.4** MIL-HDBK-759B, 5.7.2.1.3.1  
**12.3.2** MIL-STD-1472D, 5.13.5.2; DOE-STAND HFAC 1, 10.6.2  
**12.3.3** MIL-HDBK-759B, 5.7.3.6  
**12.3.4** MIL-HDBK-759B, 5.7.3.6  
**12.3.5** NASA-STD-3000A, 6.3.3.10  
**12.3.6** NASA-STD-3000A, 6.3.3.10  
**12.3.7** MIL-HDBK-759B, 5.7.2.1.2.1  
**12.4** MIL-HDBK-759B, 5.7.2.1.1; NASA-STD-3000A, 6.4.2, exhibit pp. 6-6, 6-7  
**12.4.1** MIL-HDBK-759B, 5.7.2.1.3  
**12.4.1.1** MIL-HDBK-759B, 5.7.2.1.2; MIL-STD-454M, Requirement 1, 4.4.3  
**12.4.1.2** FAA Order 3900.19A, chapter 11, paragraph 144  
**12.4.1.3** FAA Order 3900.19A, chapter 11, paragraph 144  
**E12.4.1.3** Federal Regulation Vol 59, No.20, Pg. 4436  
**12.4.1.4** NASA-STD-3000A, 6.4.3.3.10  
**12.4.1.5 29** CFR 1910.7; MIL-STD-454M, Requirement 1, 4.1  
**12.4.1.6** NASA-STD-3000A, 6.4.3.3.2  
**12.4.1.7** MIL-STD-454M, Requirement 1, 4.4.1  
**12.4.1.8** NASA-STD-3000A, 6.4.3.3.2  
**12.4.1.9** MIL-HDBK-759B, 5.7.2.1.3.1; NASA-STD-3000A, 6.4.3.3.3; MIL-STD-454M, Requirement 1, 4.4.4.1.b  
**12.4.1.10** MIL-STD-454M, Requirement 1, 4.4.4.1.c; 4.5.1  
**12.4.1.11** AFSC DH 1-3, DN 2G3; UCRL-15673, 1.4.4.4.c; MIL-HDBK-759B, 5.7.3.2.2  
**12.4.1.12** MIL-STD-454M, Requirement 1, 4.4.3.1  
**12.4.1.13** MIL-STD-454M, Requirement 1, 4.4.3.2  
**12.4.1.14** MIL-STD-454M, Requirement 1, 4.4.3.4  
**12.4.1.15** MIL-HDBK-759B, 5.7.3.5.2  
**12.4.1.16** MIL-STD-1472D, 5.13.7.1.2; NASA-STD-3000A, 6.4.3.3.6.a  
**12.4.1.17** MIL-STD-1472D, 5.13.7.1.3; MIL-HDBK-759B, 5.6.9.3.1  
**12.4.2.1** MIL-HDBK-759B, 5.7.2.1.3.3  
**12.4.2.2 29** CFR1910.333(b)(2); MIL-STD-454M, Requirement 1, 4.6.2  
**12.4.2.3** MIL-STD-454M, Requirement 1, 4.4.3.5  
**12.4.2.4** MIL-HDBK-759B, 5.7.2.1.3.3  
**12.4.2.5** MIL-STD-454M, Requirement 1, 4.4.4.3  
**12.4.2.6** MIL-HDBK-759B, 5.7.2.1.3.3  
**12.4.3.1** MIL-HDBK-759B, 5.7.2.1.3.4; MIL-STD-454M, Requirement 1, 4.4.5.1  
**12.4.3.2** MIL-STD-454M, Requirement 1, 4.4.5.1  
**12.4.3.3** MIL-HDBK-759B, 5.7.2.1.3.4  
**E12.4.3.3** MIL-HDBK-759B, 5.7.2.1.3.4

- 12.4.3.4 MIL-STD-454M, Requirement 1, 4.4.5.1
- 12.4.4 MIL-HDBK-759B, 5.7.2.1.4.1
- 12.4.4.1 MIL-HDBK-759B, 5.7.2.1.4; NASA-STD-3000A, 6.4.3.3.1; MIL-STD-454M, Requirement 1, 4.4.2
- 12.4.4.2 MIL-STD-454M, Requirement 1, 4.4.2.2
- 12.4.4.3 MIL-HDBK-759B, 5.7.2.1.4.1
- 12.4.4.4 MIL-HDBK-759B, 5.7.2.1.4.1
- 12.4.4.5 MIL-HDBK-759B, 5.7.2.1.4.1
- 12.4.4.6 MIL-HDBK-759B, 5.7.2.1.4.2
- E12.4.4.6 MIL-HDBK-759B, 5.7.2.1.4.2
- 12.4.4.7 MIL-STD-454M, Requirement 1, 4.4.2.2
- 12.4.4.8 MIL-STD-454M, Requirement 1, 4.4.2.3
- 12.4.4.9 MIL-STD-454M, Requirement 1, 4.4.2.3
- 12.4.4.10 MIL-STD-454M, Requirement 1, 4.4.2.2
- 12.4.4.11 MIL-STD-454M, Requirement 1, 4.4.2.2
- 12.4.4.12 MIL-HDBK-759B, 5.7.2.1.4.3
- 12.4.5.1 MIL-STD-1472D, 5.13.7.1.1; NASA-STD-3000A, 6.4.3.3.7.b
- 12.4.5.2 MIL-STD-1472D, 5.13.7.1.6; NASA-STD-3000A, 6.4.3.3.8
- 12.4.5.3 MIL-STD-1472D, 5.13.7.1.6
- 12.4.5.4 MIL-STD-454M, Requirement 1, 4.4.2.1
- 12.5.1.1 NASA-STD-3000A, 6.3.3.3
- 12.5.1.2 MIL-HDBK-759B, 5.7.3.1
- 12.5.1.3 UCRL-15673, 1.11.4.5; MIL-HDBK-759B, 5.7.3.1
- 12.5.1.4 NASA-STD-3000A, 6.3.3.1
- E12.5.1.4
- a. NASA-STD-3000A, 6.3.3.1.d
- b. NASA-STD-3000A, 6.3.3.1.c
- c. NASA-STD-3000A, 6.3.3.1.b
- d. NASA-STD-3000A, 6.3.3.1.a
- 12.5.1.5 NASA-STD-3000A, 6.3.3.2
- E12.5.1.5
- a. NASA-STD-3000A, 6.3.3.2.a
- b. NASA-STD-3000A, 6.3.3.2.b
- 12.5.1.6 MIL-HDBK-759B, 5.7.3.1
- 12.5.1.7 NASA-STD-3000A, 6.3.3.5
- 12.5.1.8 NASA-STD-3000A, 6.3.3.8
- 12.5.1.9 NASA-STD-3000A, 6.3.3.9
- 12.5.1.10 NASA-STD-3000A, 6.3.3.6
- 12.5.1.11 MIL-HDBK-759B, 5.7.3.2.1
- 12.5.2.1 MIL-HDBK-759B, 5.7.3.2
- 12.5.2.2 MIL-HDBK-759B, 5.7.3.2.1.1
- 12.5.2.3 AFSC DH 1-3, DN 2G3
- 12.5.2.4 MIL-HDBK-759B, 5.7.3.2
- 12.5.2.5 MIL-HDBK-759B, 5.7.3.2
- 12.6.1 FAA-G-2100, 3.3.6.6.2; MIL-STD-454M, Requirement 1, 4.8.1
- 12.6.2 UCRL-15673, 1.7.3.5
- 12.6.3 MIL-STD-1472D, 5.13.7.3.2
- 12.6.4 MIL-HDBK-759B, 5.6.16.2.1; UCRL-15673, 1.6.4.2.a
- 12.6.5 FAA-G-2100, 3.3.6.6.3; MIL-STD-454M, Requirement 1, 4.8.2
- 12.7.1 MIL-STD-1472D, 5.13.7.4.1; MIL-STD-1800A, 4.1.10; MIL-HDBK-759B, 5.7.3.3
- 12.7.2 29CFR 1910.100; MIL-STD-1472D, 5.13.7.4.2; MIL-HDBK-759B, 5.4.7.2
- 12.7.3 FAA Order 6000.15, 179.a
- 12.7.4 FAA Order 6000.15B, 185.a.3
- 12.7.5 New
- 12.7.6 FAA-G-2100, 3.3.6.6.3
- 12.8 MIL-HDBK-759B, 5.7.3.7
- 12.8.1 FAA-G-2100, 3.3.6.6.4; MIL-STD-454M, Requirement 1, 4.8.3
- 12.8.2 FAA-G-2100, 3.3.6.6.4; MIL-STD-454M, Requirement 1, 4.8.3
- 12.8.3 MIL-STD-1472D, 5.13.7.5; MIL-STD-1800A, 4.1.9
- 12.8.4 29CFR 1910.97
- 12.9.1 FAA Order 3900.19A, chapter 8, paragraph 107.e.1
- 12.9.2 FAA Order 3900.19A, chapter 8, paragraph 107.e.1
- 12.9.3 FAA Order 3900.19A, chapter 8, paragraph 107.e.1
- 12.9.4 FAA Order 3900.19A, chapter 8, paragraph 107.e.1
- 12.9.5 FAA Order 6000.15B, 181
- 12.9.6 FAA Order 6000.15B, 189; FAA Order 1050.14
- 12.9.7 MIL-STD-454M, Requirement 1, 23, 5.5
- 12.10.1 DOE-STAND HFAC 1, 10.4.6; MIL-STD-1472D, 5.13.4.6; MIL-STD-454M, Requirement 1, 4.3
- 12.10.2 MIL-HDBK-759B, 5.7.3.2.1.1
- 12.11.1 MIL-HDBK-759B, 5.7.3.3
- 12.11.2 MIL-HDBK-759B, 5.7.3.3
- 12.11.3 MIL-HDBK-759B, 5.7.3.3
- 12.11.4 MIL-HDBK-759B, 5.7.3.3.1
- 12.11.5 MIL-HDBK-759B, 5.7.3.3.1
- 12.12.1 MIL-STD-1800A, 4.1.12
- 12.12.2 MIL-STD-1800A, 4.1.12
- 12.12.3 MIL-HDBK-759B, 5.4.6.3.5
- 12.12.4 FAA-G-2100, 3.3.7.1.3; MIL-HDBK-759B, 5.4.6.3.4
- 12.12.5 FAA-G-2100, 3.3.7.1.1; MIL-HDBK-759B, 5.4.6.3.3
- 12.12.6 FAA-G-2100, 3.3.7.1.2; MIL-HDBK-759B, 5.4.6.3.2
- 12.12.7 FAA-G-2100, 3.3.7.1.4
- 12.12.8 29 CFR 1910.95
- 12.13.1 MIL-HDBK-759B, 5.7.3.5.1; MIL-STD-454M, Requirement 1, 4.6.3
- 12.13.2 MIL-HDBK-759B, 5.7.3.5.1
- 12.13.3 MIL-HDBK-759B, 5.7.3.5.2
- 12.13.4 MIL-HDBK-759B, 5.7.3.5.2
- 12.13.5 MIL-STD-454M, Requirement 1, 4.8.1
- 12.13.6 FAA Order 3900.19A, chapter 11, paragraph 155
- 12.14.1.1 Design Handbook for Imagery Interpretation Equipment, 6.8.1.1
- 12.14.2.1 Design Handbook for Imagery Interpretation Equipment, 6.8.1.2
- 12.14.2.2 Design Handbook for Imagery Interpretation Equipment, 6.8.1.2

- 12.14.3** Design Handbook for Imagery Interpretation Equipment, 6.8.1.3
- 12.14.3.1** Design Handbook for Imagery Interpretation Equipment, 6.8.1.3
- 12.14.3.2** Design Handbook for Imagery Interpretation Equipment, 6.8.1.3
- 12.14.3.3** Design Handbook for Imagery Interpretation Equipment, 6.8.1.3
- 12.14.3.4** Design Handbook for Imagery Interpretation Equipment, 6.8.1.3
- 12.14.4.1** Design Handbook for Imagery Interpretation Equipment, 6.8.1.4
- 12.14.4.2** Design Handbook for Imagery Interpretation Equipment, 6.8.1.4
- 12.14.5.1** Design Handbook for Imagery Interpretation Equipment, 6.8.1.5
- 12.16.1** MIL-STD-1472D, 5.13.2.1; MIL-HDBK-759B, 5.7.2.1.2.1; DOE-STAND HFAC 1, 10.2.1; NASA-STD-3000A, 6.4.3.3.5; MIL-STD-454M, Requirement 1, 4.7
- 12.16.2** MIL-STD-1472D, 5.13.4.5
- 12.16.3** MIL-STD-454M, Requirement 1, 4.7.b
- 12.16.4** MIL-HDBK-759B, 5.7.2.1.2.3; MIL-STD-454M, Requirement 1, 4.7.c
- 12.16.5** MIL-STD-454M, Requirement 1, 4.7.d
- 12.16.6** MIL-STD-454M, Requirement 1, 4.7.f
- 12.16.7** MIL-STD-454M, Requirement 1, 4.7.i
- 12.16.8** MIL-STD-454M, Requirement 1, 4.7.e
- 12.16.9** DOE-STAND HFAC 1, 10.3; MIL-STD-1472D, 5.13.3
- 12.16.10** DOE-STAND HFAC 1, 10.2.6; MIL-STD-1472D, 5.13.2.6
- 12.16.11** MIL-STD-1472D, 5.13.2.2; DOE-STAND HFAC 1, 10.2.2
- 12.16.12** MIL-HDBK-759B, 5.6.18.6.1; MIL-STD-1800A, 4.3.18.3
- 12.16.13** MIL-STD-1472D, 5.13.2.3; MIL-HDBK-759B, 5.7.3.6.1; DOE-STAND HFAC 1, 10.2.3
- 12.16.14** MIL-STD-1472D, 5.13.2.4; DOE-STAND HFAC 1, 10.2.4
- 12.16.15** MIL-STD-1472D, 5.13.2; DOE-STAND HFAC 1, 10.2.7
- 12.16.16** MIL-STD-1472D, 5.13.2.5; DOE-STAND HFAC 1, 10.2.5
- 13** 21b, 24, 33
- 13.1.1** MIL-HDBK-759B, 5.4.1.2
- 13.1.2** MIL-HDBK-759B, 5.4.1.2
- 13.2.1** MIL-STD-1800A, Appendix p. 99
- 13.2.2** MIL-STD-1472D, 5.8.1.2; MIL-HDBK-759B, 5.4.2.7
- 13.2.3** MIL-STD-1472D, 5.8.1.2; MIL-HDBK-759B, 5.4.2.7
- E13.2.3** MIL-STD-1472D, 5.8.1.7; MIL-HDBK-759B, 5.4.2.7; MIL-STD-1800A, 4.1.5
- 13.2.4** MIL-STD-1800A, Appendix, page 99
- 13.2.5** MIL-STD-1472D, 5.8.1.2; MIL-HDBK-759B, 5.4.2.7
- 13.2.6** MIL-STD-1472D, 5.8.1.2; MIL-HDBK-759B, 5.4.2.7
- 13.2.7** MIL-STD-1800A, Appendix, page 99
- 13.2.8** New
- E13.3** Design Handbook for Imagery Interpretation Equipment, p. 7.4.2
- 13.3.1** MIL-STD-1472D, 5.8.1.7
- E13.3.1** MIL-HDBK-759B, 5.4.2.2; MIL-STD-1472D, 5.8.1.1; MIL-STD-1800A, 4.1.2
- 13.3.2** MIL-STD-1472D, 5.8.1.1
- 13.3.3** MIL-STD-1472D, 5.8.1.3
- 13.3.4** MIL-STD-1472D, 5.8.1.1; MIL-HDBK-759B, 5.4.2.5
- 13.3.5** MIL-STD-1472D, 5.8.1.3
- 13.3.6** MIL-HDBK-759B, 5.4.2.2.1
- 13.3.7** MIL-HDBK-759B, 5.4.2.2.1
- 13.3.8** MIL-HDBK-759B, 5.4.2.2.1
- 13.3.9** MIL-HDBK-759B, 5.4.2.2.1
- 13.3.10** MIL-STD-1800A, 4.1.2
- 13.3.11** MIL-STD-1472D, 5.8.1.4
- 13.3.12** MIL-STD-1800A, 5.1.2
- 13.3.13** MIL-STD-1800A, 5.1.2
- 13.4.1.1** MIL-STD-1472D, 5.8.2
- 13.4.1.2** MIL-STD-1472D, 5.8.2
- 13.4.1.3** NASA-STD-3000A, 8.13.2.4
- 13.4.2.1** NASA-STD-3000A, 8.13.3.1.2
- 13.4.2.2** NASA-STD-3000A, 8.13.3.6
- 13.4.2.3** NASA-STD-3000A, 8.13.3.6
- 13.4.3.1** NASA-STD-3000A, 8.13.3.1.4
- 13.4.3.2** d. NASA-STD-3000A, 8.13.3.1.4
- 13.4.3.3** MIL-HDBK-759B, 5.4.5.8.2
- 13.4.4.1** e. NASA-STD-3000A, 8.13.3.2.1
- 13.4.5.1** NASA-STD-3000A, 8.13.3.2.2
- 13.4.5.2** NASA-STD-3000A, 8.13.3.2.2
- 13.4.5.3** NASA-STD-3000A, 8.13.3.2.2
- 13.4.5.4** NASA-STD-3000A, 8.13.3.2.2
- 13.4.5.5** NASA-STD-3000A, 8.13.3.2.2
- 13.4.6.1** NASA-STD-3000A, 8.13.3.2.3
- 13.4.6.2** NASA-STD-3000A, 8.13.3.2.3
- 13.4.6.3** NASA-STD-3000A, 8.13.3.2.3
- 13.4.7.1** NASA-STD-3000A, 8.13.3.4; FAA Order 6950.2C, 8.a.1
- 13.4.7.2** NASA-STD-3000A, 8.13.3.4
- 13.4.7.3** NASA-STD-3000A, 8.13.3.4
- 13.4.7.4** NASA-STD-3000A, 8.13.3.4
- 13.4.7.5** NASA-STD-3000A, 8.13.3.4
- 13.4.7.6** NASA-STD-3000A, 8.13.3.4
- 13.4.7.7** NASA-STD-3000A, 8.13.3.4
- 13.5.1.1** FAA Order 3910.4, 7.a
- 13.5.1.2** FAA Order 3910.4, 7.a
- 13.5.1.3** FAA Order 3910.4, 8
- 13.5.1.4** FAA Order 3910.4, 9, 10
- 13.5.2.1** ANSI/HFS 100-1988, 5.5
- 13.5.2.2** MIL-STD-1800A, 4.1.12
- 13.5.2.3** MIL-STD-1800A, 4.1.12
- 13.5.2.4** MIL-STD-1800A, 4.1.12
- 13.5.2.5** MIL-HDBK-759B, 5.4.6.3.5
- 13.5.2.6** FAA-G-2100, 3.3.7.1.3; MIL-HDBK-759B, 5.4.6.3.4
- 13.5.2.7** FAA-G-2100, 3.3.7.1.1; MIL-HDBK-759B, 5.4.6.3.3

- 13.5.2.8 FAA-G-2100, 3.3.7.1.2; MIL-HDBK-759B, 5.4.6.3.2
- 13.5.2.9 FAA-G-2100, 3.3.7.1.4
- 13.5.2.10 29 CFR 1910.95
- 14 SMEs 23, 24; NASA-STD-3000A, 3.1.1, Appendix B Vol 2; AFSC DH 1-3, DN 2B11.1; Kromer: Salvendi, 1987;
- 14.1.1.1 NASA-STD-3000A, 3.2.1.b
- 14.1.1.2 NASA-STD-3000A, 3.2.1.b
- 14.1.1.3 NASA-STD-3000A, 3.2.1.b
- 14.1.2.1 New
- 14.1.2.2 New
- 14.1.2.3 New
- 14.1.2.4 MIL-STD-1472D, 5.6.3.2
- 14.1.2.5 New
- 14.1.2.6 MIL-STD-1472D, 5.6.3.3
- 14.1.2.7 New
- 14.1.2.8 MIL-STD-1472D, 5.6.3.4
- 14.1.2.9 MIL-STD-1472D, 5.6.3.5
- 14.1.2.10 MIL-STD-1472D, 5.6.3.5
- 14.1.3.1 NASA-STD-3000A, 3.2.1.c
- 14.1.3.2 AFSC DH 1-3, 2B11, 2; NASA-SID-3000A, 3.2.1.e
- 14.1.3.3 NASA-STD-3000A, 3.2.1.d
- 14.1.4.1 New
- 14.1.4.2 DoD-HBK-743; Roebuck, Kroemer, and Thomas, 1975
- 14.1.4.3 New
- 14.1.4.4 DoD-HBK-743;
- 14.1.4.5 New
- 14.1.4.6 New
- 14.1.4.7 (NATICK/TR 84-034); MIL-HDBK-759B, 5.3.2.3.1; Johnson, 1984
- E14.1.4.7 MIL-HDBK-759B, 5.3.2.4.2.4; MIL-STD-1800A, 4.2.2
- 14.1.4.8 New
- 14.1.5.1 Israelski, HF Handbook for Telecommunications
- 14.1.5.2 MIL-HDBK-759B, 5.3.2.3.7.5
- 14.1.5.3 MIL-HDBK-759B, 5.3.2.3.7.4; Kroemer, p15, 1990
- 14.1.6 New
- 14.2.1 Israelski, HF Handbook for Telecommunications
- 14.2.2 Kroemer, 1990
- 14.2.3 HF Handbook for Telecommunications p. 82
- 14.3 AFSC DH 1-3, DN 2B11, 3; NASA-STD-3000A, 3.3.1.1
- 14.3.1.1 DoD-HBK-743
- 14.3.1.2 MIL-STD-1472D, 5.6.1; MIL-HDBK-759B, 5.3.2.1
- E14.3.2.1 DOD-HDBK-743A, 5.2
- 14.3.2.2 New
- 14.3.3.1 NASA-STD-3000A, 3.3.2.1; AFSC DH 1-3, DN 2B11; HF Handbook for Telecommunications p. 97
- 14.3.3.1.1 MIL-HDBK-759B, 5.3.3.2
- 14.3.3.1.2 MIL-HDBK-759B, 5.3.3.2
- E14.3.3.2.1 NASA-STD-3000A, 3.3.2.3.1; MIL-HDBK-759B, 5.3.3.1; MIL-STD-1800A, 4.2.2
- 14.3.3.2.2 NASA-STD-3000A, 3.3.2.3.1; MIL-HDBK-759B, 5.3.3.1; MIL-STD-1800A, 4.2.2
- E14.3.3.2.2 NASA-3000A, 3.3.2.3.2-1
- 14.3.3.2.3 New
- 14.3.3.2.4 New
- 14.4 NASA-STD-3000A, 3.3.3.2.4, 3.3.3.2.5
- 14.4.1 New
- 14.4.2 Roebuck, Kroemer, Thomson, 1975
- E14.4.2 Engineering Physiology, Kroemer
- 14.4.3 New
- 14.4.4 Kroemer, 1990, p.22
- E14.4.4
- a. Engineering Physiology, Kroemer
- b. NASA-STD-3000A, 3.3.3.3.1
- c. NASA-STD-3000A, 3.3.3.3.1
- 14.4.5 NASA-STD-3000A, 3.3.3.3.1
- 14.5.1 Israelski: HF Handbook for Telecommunications pp. 98, 99
- 14.5.2.1 MIL-HDBK-759B, 5.3.4.1; AFSC DH 1-3, DN 2B11; SME 23; SME 22
- E14.5.2.1 MIL-HDBK-759B, 5.3.4.1; MIL-STD-1472D, 5.4.4.2; MIL-STD-1800A, 4.2.3
- 14.5.2.2 MIL-HDBK-759B, 5.3.4.1; MIL-STD-1472D, 5.4.4.2; MIL-STD-1800A, 4.2.3; AFSC DH 1-3, DN 2B11, 5.5
- 14.5.2.3 New
- 14.5.2.5 Israelski, HF Handbook for Telecommunications
- 14.5.3.1 MIL-HDBK-759B, 5.3.4.2.1
- 14.5.3.2 MIL-HDBK-759B, 5.3.4.2.2
- E14.5.3.2 MIL-HDBK-759B, 5.3.4.2.2; MIL-STD-1472D, 5.9.11.4.2
- 14.5.4.1 AFSC DH 1-3, DN 2B11, 5.2 Handbook for Telecommunications pp. 81, 82, 83; NASA-STD-3000A, 3.2.3.3
- 14.6 New

## Appendix C "Standard" actions for push buttons

This appendix is a list of "standard" actions that can be assigned to push buttons in windows as prescribed in paragraph 8.1.15.2.5.

### C.1 Manipulating primary windows

These actions apply to windows in which users can perform multiple actions.

- Back** Moves a window to the back of the screen.
- Close** Closes the current primary window and its secondary windows in an application with multiple primary windows; requests confirmation if unsaved changes have been made and allows the user to save the changes.
- Exit** Closes all primary and secondary windows in an application and ends processing by the application.
- New** Opens a new window.
- Open** Opens an already defined window.
- Print** Initiates a process for printing the contents of a window (for example, parts of a window, full window).
- Refresh** Redraws the contents of a window.
- Save** Saves the contents of a window to a storage device.

### C.2 Manipulating files and directories

These actions may be combined with the object of the action (for example, Print file, or Print directory) if multiple actions and multiple objects are available in a window.

- Archive** Creates a backup copy of a file (for example, on magnetic tape or fixed disk).
- Close** Closes a file; requests confirmation if unsaved changes have been made to the file and allows the user to save the changes.
- Delete** Removes a file from a storage device; requests confirmation prior to deletion.
- Duplicate** Creates a copy of a file and prompts the user to name the file.

<b>New</b>	Opens a new file.
<b>Open</b>	Opens an existing file.
<b>Print</b>	Initiates a process for printing the contents of a file.
<b>Restore</b>	Retrieves the backup copy of a file and saves it to a storage device.
<b>Revert</b>	Replaces the current file with the version that was most recently saved.
<b>Save</b>	Saves a file to a storage device under the same file name; prompts the user for a name if the file does not have one.
<b>Save as</b>	Saves a copy of a file under a new name; prompts the user for the new name.

### C.3 Editing text or graphics objects

<b>Clear</b>	Removes an object from a window without copying it to the clipboard; does not compress the remaining space.
<b>Copy</b>	Duplicates an object in a window and copies the object to the clipboard.
<b>Cut</b>	Removes an object from a window and stores it in the clipboard.
<b>Delete</b>	Removes an object from a window without copying it to the clipboard; compresses the remaining space.
<b>Paste</b>	Inserts an object from the clipboard into a window at a selected location.
<b>Replace</b>	Replaces a word or character string with a different word or character string entered by the user.
<b>Search</b>	Locates an item (for example, an item in a list or a word in a text area) that matches a character string entered by the user.
<b>Spell check</b>	Compares the words in a file or text selection against a dictionary of recognized words and identifies entries not in the dictionary, that is, potentially misspelled words.
<b>Undo</b>	Returns an object to its state before the last operation was performed.

### C.4 Manipulating items

"All" may be appended to these commands (for example, **Delete all**) to indicate that the command applies to all items in a set of items.



<b>Add</b>	Adds a new item to a set of items.
<b>Compare</b>	Displays information on multiple items in a set of items.
<b>Delete</b>	Removes an item from a set of items.
<b>Deselect all</b>	Deselects (and removes highlight from) all items in a set of items.
<b>Duplicate</b>	Creates a copy of an item and adds it to a set of items.
<b>Edit</b>	Edits an item in a set of items.
<b>Insert</b>	Adds an item to a specific location within a set of items.
<b>Mark</b>	Annotates (for example, with an asterisk) an item that has been selected.
<b>Merge</b>	Combines the contents of two items into a single item.
<b>Next</b>	Displays the contents of the next item in a set of items.
<b>Select all</b>	Selects (and highlights) all items in a set of items.
<b>Sort</b>	Sorts a set of items based on a variable selected by the user.
<b>Transmit</b>	Transmits an item via a communication channel selected by the user.
<b>Unmark</b>	Removes the annotation that an item has been selected.
<b>View</b>	Displays the contents of an item.

## **C.5 Constructing and executing queries**

These actions are used in data base query commands in which the user wants to retrieve a set of items based on specific criteria (for example, data fields).

<b>Browse</b>	Allows the user to navigate through the database prior to executing a query.
<b>Compile</b>	Generates an executable version of the query and checks it for correctness.
<b>Modify</b>	Allows the user to make changes to an existing query.
<b>Run</b>	Executes the query.
<b>Save</b>	Saves a query to a storage device, providing the query with a unique name that identifies it as a query.

- Select** Identifies the fields to include in the query.
- Show** Allows the user to define the manner in which the results of the query are to be displayed.

## C.6 Paging

- Next** Displays the next page of information.
- Previous** Displays the previous page of information.

## C.7 Processing

"On" and "Off" may be appended to the name of a specific process to start and stop the process, for example, if "Monitor" is an automatic monitoring process, "Monitor On" starts the process, and "Monitor Off" stops the process.

- Continue** Continues a process that was previously paused (for example, turns on a process that has been turned off). If the Motif Style Guide is being followed, **Resume** should be used rather than **Continue**.
- GoBack** Displays the previous transaction.
- Pause** Interrupts a process without changing data entries or control logic for the process.
- Restart** Cancels entries made in a transaction sequence and returns to the beginning of a sequence.
- Resume** Resumes a process that was previously paused (for example, turns on a process that has been turned off). This name should be used rather than **Continue** if the Motif Style Guide is being followed.
- Review** Returns to the first display in a transaction sequence so that users can make changes if desired.
- Start** Begins or turns on a process.
- Stop** Ends or turns off a process at the next nondestructive breaking point.
- Suspend** Preserves the current transaction status when users log off the system and permits resumption of work when users later log on to the system.
- Update** Checks the status of a process and displays the updated information.

## C.8 Executing control settings in dialog windows

- Apply** Executes the control settings in a dialog window but does not close the window.
- Cancel** Closes a dialog window without executing the control settings in the window.
- Close** Closes a dialog window without executing the control settings in the window; used only in a working window (that is, one providing status information) or a dialog window used to perform actions that are irreversible.
- OK** Executes the control settings in a dialog window and closes the window.
- Reset** Cancels any changes made to the control settings in a dialog window that have not been applied by the application, and restores the settings to the values they had when the window was opened.

## C.9 Executing other dialog window actions

- Help** Displays on-line information about an item or general information about a window.
- No** Indicates a negative response to a question posed and removes the window containing the question.
- Yes** Indicates an affirmative response to a question posed and removes the window containing the question.

## C.10 System-level actions

- Log off** Ends processing by a system; closes all windows on the work space and stops all processing; requests confirmation if unsaved changes have been made, and allows the user to save the changes.

## Appendix D "Standard" verbs

This appendix is a list of verbs for use in writing procedural instructions for maintainers as prescribed in paragraph 10.2.4.4.1.

**Accomplish** (1) To do, carry out or bring about; (2) to reach an objective.

**Acknowledge** To respond to an originating person or computer message indicating a call or message has been received, without further commitment as to what action will be taken.

**Activate** To put an operation, system, or unit of equipment into operation.

**Actuate** (1) To put into mechanical motion or action; (2) to move to action.

**Adapt** To make fit a new situation or use, often by modifying.

**Add** To put more in.

**Adjust** (1) To bring to a specified position or state; (2) to bring to a more satisfactory state; (3) to manipulate controls or levers; (4) to return equipment from an out-of-tolerance condition to an in-tolerance condition.

**Advise** To give information or notice to.

**Advance** To move forward or ahead.

**Aggregate** To combine two or more components to form a new composite entity.

**Agitate** To move with a jerky, quick, or violent action.

**Aid** To give help or support to, to assist.

**Alert** (1) To warn; (2) to call to a state of readiness or watchfulness; (3) to notify (a person) of an impending action.

**Align** (1) To bring into line, or line up; (2) to bring into precise adjustment; (3) to correct relative position or coincidence.

**Allocate** To apportion for a specific purpose or to particular persons or things.

**Allow** (1) To permit, to give opportunity to; (2) to allot or provide for.

**Alternate** To perform or cause to occur by turns or in succession.

**Analyze** To examine and interpret test or inspection results to determine system or equipment conditions or capabilities.

---

<b>Apply</b>	(1) To lay or spread on; (2) to energize.
<b>Arrange</b>	(1) To group according to quality, value, or other characteristics; (2) to put in proper order.
<b>Ascertain</b>	To find out with certainty that a proper condition exists.
<b>Assemble</b>	(1) To fit and secure together the several parts of; (2) to make or form by combining parts.
<b>Assess</b>	(1) To determine the importance, size, or value of; (2) to evaluate.
<b>Assign</b>	(1) To apportion for a specific purpose or to particular persons or things; (2) to appoint to a duty.
<b>Assist</b>	To give support or help, to aid.
<b>Associate</b>	To establish a reference link via naming or grouping.
<b>Assure</b>	(1) To make someone sure or certain; (2) to inform positively.
<b>Attach</b>	To join or fasten to.
<b>Back off</b>	To cause to go in reverse or backward.
<b>Balance</b>	To equalize in weight, height, number, or proportion.
<b>Be sure</b>	To confirm that a proper condition exists, to find out with certainty.
<b>Be careful</b>	To exercise caution, to take care.
<b>Bend</b>	To turn or force from straight or even to curved or angular, or to force back to an original straight or even position.
<b>Bleed</b>	To extract or let out some or all of a contained substance.
<b>Blow</b>	To send forth air, particularly from the lungs through the mouth.
<b>Break</b>	(1) To separate into parts with suddenness or violence; (2) to pull away.
<b>Buck</b>	To reseal or tighten rivets from the shank side.
<b>Calculate</b>	To determine by arithmetic processes.
<b>Calibrate</b>	To determine accuracy, deviation, or variation by special measurement or by comparison with a standard.
<b>Cap</b>	(1) To provide with a covering; (2) to install or provide with a device for closing off the end of a tube or opening.

<b>Care for</b>	To take responsibility for the proper handling and upkeep of.
<b>Catch</b>	(1) To prevent from falling to the ground; (2) to capture.
<b>Categorize</b>	To put into categories or general classes.
<b>Center</b>	(1) To adjust so that axes coincide; (2) to place in the middle of.
<b>Change</b>	(1) To replace with another comparable item; (2) to substitute serviceable equipment for malfunctioning, worn out or damaged equipment; (3) to alter a facility or system parameter, such as changing radar antenna polarization.
<b>Channel</b>	To form, cut, or wear a groove in.
<b>Charge</b>	To restore the active materials in a storage battery by the passage of a direct current through in the opposite direction to that of the discharge.
<b>Check</b>	(1) To confirm or establish that a proper condition exists; (2) to ascertain that a given operation produces a specified result; (3) to examine for satisfactory accuracy, safety, or performance; (4) to confirm or determine measurements by use of visual or mechanical means; (5) to perform a critical visual observation or check for specific conditions; (6) to test the condition of.
<b>Check out</b>	To perform specified operations to verify operational readiness of a subcomponent, component, subsystem, or system.
<b>Chock</b>	To place a blocking device adjacent to, in front of, and behind to keep from moving.
<b>Choke</b>	To enrich the fuel mixture of a motor by partially shutting off the air intake of the carburetor.
<b>Clamp</b>	To fasten or press two or more parts together so as to hold them firmly.
<b>Classify</b>	To put into categories or general classes.
<b>Clean</b>	(1) To wash, scrub or apply solvents to; (2) to remove dirt, corrosion, or grease.
<b>Clear</b>	To move people or objects away from.
<b>Close</b>	(1) To block against entry or passage; (2) to turn, push or pull in the direction in which flow is impeded; (3) to set a circuit breaker into the position allowing current to flow through.
<b>Coat</b>	To cover or spread with a finishing, protecting layer.
<b>Code</b>	(1) To put into the form or symbols of a system used to represent words; (2) to mark with identifying symbols.

---

<b>Collect</b>	To bring together into one body or place, to accumulate.
<b>Communicate</b>	(1) To exchange information; (2) to make known.
<b>Compare</b>	To examine the character or qualities of two or more items to discover resemblances or differences.
<b>Compile</b>	To compose or put together out of materials from several sources.
<b>Comply</b>	(1) To conform with directions or rules; (2) to accept as authority.
<b>Compute</b>	To determine by arithmetic processes.
<b>Condition</b>	To put into a proper state for work or use.
<b>Conduct</b>	(1) To lead, manage, or direct; (2) to accomplish a series of related actions to achieve a definite goal.
<b>Confer</b>	To consult, to exchange views.
<b>Connect</b>	(1) To bring or fit together so as to form a unit; (2) to couple keyed or matched equipment items; (3) to attach or mate (an electrical device) to a service outlet.
<b>Consolidate</b>	To join together into one whole, to form into a compact mass.
<b>Construct</b>	(1) To make or form by combining parts; (2) to fit and secure together the several parts of.
<b>Contact</b>	To establish communications via radio or telephone with another person.
<b>Control</b>	(1) To exercise restraining or directing influence over; (2) to fix or adjust the time, amount, or rate of.
<b>Coordinate</b>	To bring into a common action, movement, or condition.
<b>Copy</b>	To make an imitation, transcript, or reproduction of.
<b>Correct</b>	(1) To make or set right; (2) to alter or adjust so as to bring to some standard or required condition.
<b>Cover</b>	To protect or shelter by placing something over or around.
<b>Crimp</b>	To compress or deform a connection barrel around a cable to make an electrical connection.
<b>Cross-reference</b>	To access or look up related information, usually by means of an indexing or organized structuring scheme set up for that purpose.

---

<b>Cut</b>	(1) To divide into parts using a sharp instrument such as a scissors or knife; (2) to remove a designated portion of an entity and place it in a special-purpose buffer (computer usage).
<b>Cycle</b>	To charge (a battery) for a short time.
<b>Decide</b>	To arrive at an answer, choice, or conclusion via analysis, synthesis, or assessment.
<b>Deflate</b>	To release air or gas from.
<b>Deplete</b>	To lessen markedly in quantity, content, or power.
<b>Depress</b>	To press or push down.
<b>Depressurize</b>	To release gas or fluid pressure from.
<b>Destroy</b>	(1) To ruin, demolish, or put out of existence; (2) to make unfit for further use.
<b>Detect</b>	To discover or determine the existence, presence, or fact of.
<b>Determine</b>	(1) To obtain definite and first-hand knowledge of; (2) to confirm or establish that a proper condition exists; (3) to investigate and discover by study or experiment.
<b>Develop</b>	To set forth or make clear by degrees or in detail.
<b>Devise</b>	(1) To form by new combinations or applications of ideas or principles; (2) to invent.
<b>Diagnose</b>	To recognize and identify the cause or nature of a condition, situation, or problem by examination or analysis.
<b>Direct</b>	To issue instructions that a certain action be taken.
<b>Disassemble</b>	(1) To take to pieces; (2) to take apart to the level of the next smaller unit or down to all removable parts.
<b>Disassociate</b>	To eliminate a reference link by renaming or ungrouping.
<b>Disconnect</b>	(1) To sever the connection between; (2) to separate keyed or matched equipment parts; (3) to detach or separate (an electrical device) from a service outlet.
<b>Discriminate</b>	To classify or differentiate an entity grossly by group or set membership, frequently on the basis of only a limited number of attributes.
<b>Disengage</b>	(1) To release or detach interlocking parts, to unfasten; (2) to set free from an inactive or fixed position.
<b>Dismantle</b>	(1) To take to pieces; (2) to take apart to the level of the next smaller unit or down to all removable parts.



<b>Dispatch</b>	To send off or away with promptness or speed.
<b>Dispose of</b>	To get rid of.
<b>Distribute</b>	(1) To apportion for a specific purpose or to particular persons or things; (2) to divide among several or many; to divide or separate, especially into kinds.
<b>Drain</b>	To draw off (liquid) gradually or completely.
<b>Draw in</b>	To pull (liquid) up into a container through suction.
<b>Dry</b>	To cause to be free from water or liquid.
<b>Effect</b>	(1) To do, carry out, or bring about; (2) to reach an objective.
<b>Eliminate</b>	(1) To expel; (2) to ignore or set aside as unimportant.
<b>Employ</b>	(1) To put into action or service; (2) to carry out a purpose or action by means of; (3) to avail one-self of.
<b>Enforce</b>	To compel or constrain.
<b>Engage</b>	To cause to interlock or mesh.
<b>Enter</b>	(1) To go or come in; (2) to put on record; (3) to insert data, text, or a system message into the computer system (computer usage).
<b>Erase</b>	To remove stored data from a storage medium such as a CRT display or magnetic tape.
<b>Erect</b>	To put up by fitting together.
<b>Establish</b>	To set on a firm basis.
<b>Estimate</b>	To judge or determine roughly the size, extent, or nature of.
<b>Evaluate</b>	(1) To determine the importance, size, or nature of; (2) to appraise; (3) to give a value or appraisal to on the basis of collected data.
<b>Examine</b>	(1) To perform a critical visual observation or check for specific conditions; (2) to test the condition of.
<b>Execute</b>	To initiate or activate any of a set of predefined utilities or special-purpose functions (for example, sort, merge, calculate, update, extract, search, replace).
<b>Expedite</b>	To accelerate the process or progress of.
<b>Extend</b>	To cause to be drawn out to fullest length.
<b>Extract</b>	To draw forth, to pull out forcibly.

<b>Extrapolate</b>	(1) To assign an approximate value to a future point based upon the value(s) of the preceding point(s); (2) to extend or estimate mentally the position of one or more mobile objects in time and space.
<b>Fabricate</b>	To construct from standardized parts.
<b>Figure</b>	To determine by arithmetic processes.
<b>File</b>	To rub, smooth, or cut away with a file.
<b>Fill</b>	To put in as much as can be held or conveniently contained, or to a specified level.
<b>Find</b>	(1) To discover or determine by search; (2) to indicate the place, site, or limits of; (3) to discover by study or experiment; (4) to investigate and decide.
<b>Flush</b>	(1) To pour liquid over or through; (2) to wash out with a rush of liquid.
<b>Fold</b>	(1) To lay one part over another part of; (2) to reduce the length or bulk by doubling over.
<b>Follow</b>	(1) To accept as authority; (2) to obey; (3) to conform with directions or rules.
<b>Form</b>	(1) To give a particular shape to; (2) to shape or mold into a certain state; (3) to make up.
<b>Formulate</b>	To compose mentally or prepare the content of a message or plan, including all required or pertinent elements thereof.
<b>Forward</b>	To send information verbally or electronically to another position.
<b>Furnish</b>	To supply what is needed, to equip.
<b>Go to</b>	(1) To proceed to; (2) to transport oneself to a given destination.
<b>Ground</b>	To connect a current, wire, or piece of electrical equipment to a land or other specified surface.
<b>Group</b>	To link together or associate for purposes of identification.
<b>Guard</b>	To protect from danger, to defend.
<b>Guide</b>	To manage or direct the movement of.
<b>Hand</b>	To give, pass, or transmit with the hands.
<b>Handle</b>	To manipulate (for example, load, turn, or raise) objects and equipment manually or with specially designated equipment, such as hoists.

<b>Hang</b>	To fasten to an elevated point without support from below, to suspend.
<b>Help</b>	To give support, aid, or assistance to.
<b>Hold</b>	To have or keep in the grasp.
<b>Identify</b>	(1) To establish the identity of; (2) to determine the classification of an item.
<b>Idle</b>	To run an engine under reduced power.
<b>Immerse</b>	To plunge into something that surrounds or covers, especially to plunge or dip into a fluid.
<b>Improve</b>	(1) To make greater in amount or degree; (2) to make better.
<b>Indicate</b>	To point out.
<b>Inflate</b>	To fill with a given amount of gas or air.
<b>Inform</b>	(1) To make known to; (2) to give notice or report the occurrence of.
<b>Initiate</b>	(1) To perform actions necessary to set into operation; (2) to set going; (3) to begin.
<b>Inject</b>	To throw, drive, or force in.
<b>Insert</b>	(1) To put or thrust in, into, or through; (2) to make space for and place an entity at a selected location within the bounds of another, such that the latter wholly encompasses the former, and the former becomes an integral component of the latter.
<b>Inspect</b>	(1) To perform a critical visual observation or check for specific conditions; (2) to test the condition of.
<b>Install</b>	(1) To perform operations necessary to properly fit a unit of equipment into the next larger assembly or system; (2) to place and attach.
<b>Instruct</b>	To teach, educate, or provide remedial data.
<b>Insure</b>	To make certain, to ensure.
<b>Integrate</b>	(1) To put together and organize a variety of data elements; (2) to extract the information contained therein.
<b>Intercept</b>	To stop or interrupt the progress or course of.
<b>Interchange</b>	To put each in the place of the other.
<b>Interpolate</b>	To assign an approximate value to an interim point based upon knowledge of values of two or more bracketing reference points.

<b>Interpret</b>	To explain the meaning of.
<b>Itemize</b>	To list or specify the various components of a grouping.
<b>Investigate</b>	To observe or study by close examination and systematic inquiry.
<b>Isolate</b>	To use test equipment to identify or select a source of trouble.
<b>Jack</b>	To use one or more jacks (that is, mechanisms for exerting pressure) to lift all or part of an object.
<b>Join</b>	(1) To bring or fit together so as to form a unit; (2) to couple keyed or matched equipment items.
<b>Keep</b>	To remain or continue in a place.
<b>Kick</b>	To strike against with a foot.
<b>Latch</b>	To catch with a device that holds a door when closed, even if not bolted.
<b>Leave</b>	(1) To go away from, depart; (2) to allot or provide for.
<b>Let</b>	(1) To permit; (2) to give opportunity to.
<b>Level</b>	To cause an object to become even or parallel with the plane of the horizon.
<b>Lift</b>	To move or cause to be moved from a lower to a higher position, to elevate.
<b>Light</b>	To cause to illuminate.
<b>Listen</b>	To pay attention to sound.
<b>Load</b>	To place in or on a means of conveyance.
<b>Locate</b>	(1) To find, determine, or indicate the place, site, or limits of; (2) to set or establish in a particular spot.
<b>Lock</b>	(1) To hold fast or inactive, to fix; (2) to secure by key or combination.
<b>Log off</b>	To carry out a standard procedure to remove oneself from operating on a computer system or application (computer usage).
<b>Log on</b>	To carry out a standard procedure to establish oneself as operating on a particular computer workstation.
<b>Look</b>	To ascertain by the use of one's eyes.
<b>Loop</b>	To make into the form or shape of a loop, that is, a fold or doubling of line leaving an aperture between the parts through which a line or other object can be passed.

<b>Loosen</b>	(1) To release from restraint; (2) to cause to become less tight fitting.
<b>Lower</b>	(1) To cause to move down; (2) to depress as to direction.
<b>Lubricate</b>	To put lubricant on specified locations.
<b>Maintain</b>	(1) To hold or keep in any particular state or condition, especially in a state of efficiency or validity; (2) to sustain or keep up.
<b>Make</b>	To carry out or cause to occur.
<b>Mark</b>	To label, to provide with an identifying or indicating symbol.
<b>Mate</b>	To join or fit together, to couple.
<b>Measure</b>	To determine dimensions, capacity, or amount by use of standard instruments.
<b>Mix</b>	To combine or blend into one mass.
<b>Modify</b>	To alter or change somewhat the form or qualities of.
<b>Monitor</b>	(1) To take note of visually; (2) to pay attention to in order to check on action or change; (3) to continually or periodically attend to displays to determine equipment condition or operating status.
<b>Mount</b>	To attach to a support.
<b>Move</b>	To change the location or position of.
<b>Name</b>	To give a title to or attach a label to, for purpose of identification or reference.
<b>Neutralize</b>	(1) To destroy the effectiveness of, to nullify; (2) to make chemically neutral or electrically inert.
<b>Notify</b>	(1) To make known to; (2) to give notice or report the occurrence of.
<b>Observe</b>	(1) To conform one’s actions or practice to; (2) to take note of visually; (3) to pay attention to.
<b>Obtain</b>	(1) To get or find out by observation or special procedures; (2) to gain or attain.
<b>Open</b>	(1) To move from a closed position; (2) to make available for passage by turning in an appropriate direction; (3) to make available for entry or passage by turning back, removing, or clearing away; (4) to disengage or pull.
<b>Operate</b>	To control equipment in order to accomplish a specific purpose.

<b>Order</b>	(1) To requisition or request from supply; (2) to group according to quality, value, or other characteristics.
<b>Organize</b>	To arrange elements into a whole of interdependent parts, to form into a coherent unity, to integrate.
<b>Orient</b>	(1) To acquaint with the existing situation or environment; (2) to set or arrange in any determinate position.
<b>Originate</b>	(1) To give rise to, to begin; (2) to set going.
<b>Overhaul</b>	To disassemble a unit of equipment, clean, inspect, repair, restore and replace as necessary, assemble, adjust, align, recalibrate, verify operational readiness, and package for transportation or storage.
<b>Overlay</b>	To superimpose one entity on top of another to yield a composite appearance while still retaining the separability of each component layer.
<b>Pack</b>	To fill completely with grease.
<b>Paint</b>	To apply color or pigment (suspended in suitable liquid) to the surface of.
<b>Patch</b>	To mend, cover, or fill up a hole or weak spot.
<b>Perceive</b>	To recognize an action or situation as it evolves over time in the absence of any specific indicator.
<b>Perform</b>	(1) To do, carry out, or bring about; (2) to reach an objective.
<b>Place</b>	To put or set in a desired location or position.
<b>Plan</b>	To devise or project the achievement of.
<b>Plug</b>	To close a tube or opening.
<b>Plug in</b>	To attach or mate (an electrical device) to a service outlet.
<b>Position</b>	(1) To put or set in a given place; (2) to locate.
<b>Post</b>	To station at a given place.
<b>Prepare</b>	To make ready, to arrange things in readiness.
<b>Prescribe</b>	(1) To lay down as a guide, direction, or rule of action; (2) to specify with authority.
<b>Pre-set</b>	To put in a desired position, adjustment, or condition beforehand.
<b>Press</b>	To act upon through thrusting force exerted in contact.

<b>Pressurize</b>	To apply pressure within by filling with gas or liquid.
<b>Prevent</b>	To keep from happening or existing.
<b>Print</b>	To make a paper copy of a document, file, or screen.
<b>Probe</b>	To investigate thoroughly with a long, pointed device or by direct feeling.
<b>Process</b>	To submit to a series of actions or operations leading to a particular end.
<b>Program</b>	To work out a plan or procedure or a sequence of operations to be performed.
<b>Provide</b>	To supply what is needed, to equip.
<b>Pull</b>	To exert force upon an object intended to cause motion toward the force.
<b>Pump</b>	(1) To raise or lower by operating a device which raises, transfers, or compresses fluids by suction, pressure, or both; (2) to move up and down or in and out, as if with a pump handle.
<b>Puncture</b>	To pierce with a pointed instrument or object.
<b>Purge</b>	(1) To free of sediment or trapped air by flushing or bleeding; (2) to remove fuel or fuel vapors from an engine by running the engine with the fuel switched off.
<b>Push</b>	(1) To press against with force intended to cause motion away from the force; (2) to move away or ahead by steady pressure.
<b>Put</b>	(1) To place in or through; (2) to place or set in a desired position or location; (3) to deposit or leave; (4) to lay or spread on or in.
<b>Qualify</b>	To declare competent or adequate.
<b>Query</b>	To inquire of another person or of a computer to gain information or to remove doubt, as in querying a controller about a radio problem.
<b>Raise</b>	To move or cause to be moved from a lower to a higher position, to elevate.
<b>Read</b>	To interpret the meaning of by visual observation.
<b>Readjust</b>	(1) To adjust again; (2) to move back to a specified condition; (3) to bring back to an in-tolerance condition.
<b>Ready</b>	To prepare for a maintenance activity.

---

<b>Reassemble</b>	To refit and secure together the parts of a unit of equipment that has been disassembled.
<b>Recall</b>	(1) To call back; (2) to retrieve stored material, as in an information retrieval system (computer usage).
<b>Recap</b>	To cap again.
<b>Recapitulate</b>	To repeat briefly.
<b>Receive</b>	(1) To come into possession of, to get; (2) to acquire transmitted messages by seeing or listening, without necessarily taking action to express approval of receipt.
<b>Recognize</b>	To perceive to be something previously known or designated.
<b>Recommend</b>	To urge the acceptance or use of.
<b>Recondition</b>	To renew, to bring or put back into good condition.
<b>Reconnect</b>	To rejoin or refasten that which has been separated.
<b>Record</b>	To set down in writing.
<b>Reduce</b>	To cause to be diminished in strength, density, or value.
<b>Reestablish</b>	To put into operation again.
<b>Refuel</b>	To put fuel into the tanks of (an engine) again.
<b>Regulate</b>	(1) To fix or adjust the time, amount, or rate of; (2) to exercise restraining or directing influence over.
<b>Reinflate</b>	To refill with a given amount of gas or air after deflation has occurred.
<b>Reinstall</b>	To restore an item that was previously removed back into a system.
<b>Reject</b>	To refuse to have, use, or take for some purpose.
<b>Relay</b>	To pass along by stages.
<b>Release</b>	(1) To set free from an inactive or fixed position; (2) to unfasten or detach interlocking parts; (3) to let go of; (4) to set free from restraint or confinement.
<b>Relieve</b>	(1) To ease or set free of a burden; (2) to release partially.
<b>Remove</b>	(1) To perform operations necessary to take a unit of equipment out of the next larger assembly or system; (2) to take off or eliminate; (3) to take or move away.



---

<b>Rename</b>	To change an entity’s title or label without changing the entity itself.
<b>Renovate</b>	(1) To renew; (2) to bring or put back into good condition.
<b>Repair</b>	To restore a unit of equipment to operable condition by a means other than total replacement of a part.
<b>Repeat</b>	To make, do, or perform again.
<b>Replace</b>	To substitute serviceable equipment for malfunctioning, worn-out, or damaged equipment.
<b>Replenish</b>	To fill or build up again.
<b>Report</b>	(1) To describe as being in a specified state; (2) to make known, to give notice, or to report the occurrence of.
<b>Repressurize</b>	To reapply pressure within by filling with gas or liquid after pressure has been released.
<b>Request</b>	To ask for.
<b>Reset</b>	(1) To put back into a desired position, adjustment, or condition; (2) to set again or renew.
<b>Resolve</b>	(1) To clear up or find an answer to; (2) to reach a decision about.
<b>Respond</b>	To answer or reply in reaction to a message input.
<b>Restart</b>	To cause a system to begin operation again, for example, restarting a computer.
<b>Restore</b>	To bring back or put back into a former or original state.
<b>Retard</b>	To hold back or slow down.
<b>Return</b>	To bring, send, or put back to a former or proper place.
<b>Review</b>	(1) To examine again; (2) to go over or examine critically or deliberately.
<b>Rework</b>	(1) To reprocess for further use; (2) to revise.
<b>Rig</b>	To assemble, adjust, and align major components, to outfit with such things as control cables, bracing cables, pulleys, and turnbuckles.
<b>Rinse</b>	To cleanse (as from soap used in washing) with clear water.
<b>Rope off</b>	To partition, separate, or divide by a rope.

<b>Rotate</b>	To cause to revolve about an axis or center.
<b>Route</b>	(1) To send by a selected course of travel; (2) to divert in a specified direction.
<b>Rub</b>	To move along the surface of a body with pressure.
<b>Run</b>	To operate a system or unit.
<b>Safeguard</b>	(1) To provide a technical contrivance to prevent accident; (2) to comply with precautionary measures or stipulation.
<b>Safety</b>	(1) To secure a part against loosening from vibration; (2) to use safety wire to make a component fast, safe, or secure against loosening from vibration; (3) to use a cotter pin to make a component fast, safe, or secure against loosening from vibration.
<b>Safety wire</b>	To use safety wire to make a component fast, safe, or secure against loosening from vibration.
<b>Salvage</b>	To rescue or save (as from discard, wreckage, or ruin).
<b>Scan</b>	(1) To make a wide, sweeping search of; (2) to look through or over hastily.
<b>Schedule</b>	(1) To appoint, assign, or designate for a fixed future time; (2) to make a timetable of.
<b>Screw</b>	(1) To attach, fasten, or close by means of a screw; (2) to attach by means of a twisting motion in the proper direction.
<b>Scrub</b>	To clean with hard rubbing.
<b>Search</b>	To look into or over carefully or thoroughly in an effort to find or discover something.
<b>Secure</b>	(1) To make fast or safe; (2) to safety (with safety wire or a cotter pin) a component to keep it from loosening during vibration.
<b>Segregate</b>	To partition and separate an entity into two or more component parts so that the structure and identity of the original is lost.
<b>Select</b>	(1) To take by preference or fitness from a number of groups, to pick out, to choose; (2) to single out an item in preference to others on a display or panel; (3) to pick one of several available system options or items and inform the system of the choice.
<b>Service</b>	To replenish consumable supplies, such as fuel, oil, filters, air, liquid oxygen, and related items.
<b>Set</b>	(1) To put a switch, pointer, or knob into a given position; (2) to put a unit of equipment into a given adjustment, condition, or mode; (3) to put or place in a desired orientation or location.

---

<b>Set up</b>	To prepare or make ready for a maintenance activity.
<b>Shake</b>	To move or cause to move to and fro in a quick, jerky manner.
<b>Shut down</b>	To cause a unit of equipment to cease or suspend operation.
<b>Sign</b>	To affix a signature to a document, for example, signing for a supply delivery.
<b>Signal</b>	To notify or communicate by signals, that is, a prearranged sign, notice, or symbol conveying a command, warning, direction, or other message.
<b>Simulate</b>	To give the appearance or effect of.
<b>Slide</b>	To cause to move in a smooth manner over a surface.
<b>Speak</b>	To utter words or articulate sounds with the ordinary voice.
<b>Specify</b>	To name or state explicitly or in detail.
<b>Spill</b>	To cause or allow to fall, flow, or run out.
<b>Spin</b>	To cause to revolve rapidly.
<b>Spray</b>	To apply with a device that disperses a jet of finely divided liquid.
<b>Start</b>	(1) To perform actions necessary to set into operation; (2) to set going; (3) to begin.
<b>Stay</b>	To remain or continue in a place.
<b>Stimulate</b>	To excite to activity or greater activity.
<b>Stop</b>	To perform actions necessary to cause a unit of equipment to cease or suspend operation.
<b>Store</b>	To deposit or leave in a specified place for future use.
<b>Strike</b>	To deliver or aim a blow or thrust, to hit.
<b>Submit</b>	(1) To make available; (2) to offer.
<b>Suggest</b>	(1) To propose as desirable or fitting; (2) to offer for consideration.
<b>Superintend</b>	(1) To oversee; (2) to have or exercise the charge of.
<b>Supervise</b>	(1) To oversee; (2) to have or exercise the charge of.
<b>Support</b>	To hold up or provide a foundation or props for.

<b>Suppress</b>	To conceal or keep back certain aspects or products of a process without affecting the process itself (that is, affecting the appearance only).
<b>Survey</b>	To examine comprehensively as to condition, situation, or value.
<b>Suspend</b>	To stop the display of an item or the occurrence of a system process and hold it in abeyance for future recall or restoration.
<b>Switch</b>	To change a given system condition to another available condition, for example, switching communications to a backup path.
<b>Synchronize</b>	To cause to happen at the same time.
<b>Synthesize</b>	To produce new information via estimation, interpolation, translation, integration, formulation, or extrapolation.
<b>Tabulate</b>	(1) To set up in the form of a table (with rows and columns); (2) to compute by means of a table; (3) to tally or enumerate the frequencies of occurrence or values of the members of an itemized list or table.
<b>Tag</b>	(1) To provide an identifying or indicating symbol with, or as if with, a tag, that is, a cardboard, plastic or metal marker used for identification or classification; (2) to label.
<b>Take</b>	(1) To get into or carry in one’s hands or one’s possession; (2) to get or find out by observation or special procedures.
<b>Tap</b>	To strike lightly.
<b>Terminate</b>	To bring an action to an end.
<b>Test</b>	To perform specified operations to verify operational readiness of a component, sub-component, system, or subsystem.
<b>Throw</b>	To move a switch to make or break a connection.
<b>Tie</b>	To fasten, attach, or close by means of a line or cord.
<b>Tighten</b>	(1) To perform necessary operations to fix more firmly in place; (2) to apply a specified amount of force to produce a rotation or twisting motion to fix more firmly in place.
<b>Tilt</b>	To cause to slope, lean, or incline.
<b>Torque</b>	To apply a specified amount of force to produce a rotation or twisting motion to fix more firmly in place.
<b>Tow</b>	To pull along by means of a towing vehicle and tow bar.
<b>Trace</b>	To follow or study in detail or step by step.
<b>Transfer</b>	To convey or cause to pass from one place to another.

---

<b>Translate</b>	To convert or change from one form or representational system to another according to a consistent "mapping" scheme.
<b>Transmit</b>	(1) To convey or cause to pass from one place to another; (2) to send out a signal by radio waves or wire.
<b>Transport</b>	(1) To convey or cause to pass from one place to another; (2) to carry by hand or in a vehicle, hoist, or container.
<b>Trim</b>	To free of excess or extraneous matter by, or as if by, cutting.
<b>Trouble-shoot</b>	To localize and isolate the source of a malfunction.
<b>Tune</b>	To adjust for precise functioning.
<b>Turn</b>	To cause to revolve about an axis or center.
<b>Turn off</b>	To shut off or stop the flow of by, or as if by, moving a control to its OFF position.
<b>Turn on</b>	To cause to flow or operate by, or as if by, moving a control to its ON position.
<b>Uncap</b>	To remove a device that closes a tube or opening.
<b>Ungroup</b>	To eliminate the common bond or reference linkage of a group of entities.
<b>Unlock</b>	(1) To set free from an inactive or fixed position; (2) to unfasten; (3) to detach interlocking parts.
<b>Unplug</b>	(1) To detach or separate (an electrical device) from a service outlet; (2) to remove a device that closes a tube or opening.
<b>Unscrew</b>	(1) To loosen or withdraw by turning in the proper direction; (2) to draw the screws from.
<b>Unwind</b>	To cause to uncoil or unroll.
<b>Update</b>	To change or modify text or data to make it more up-to-date, as in updating electronic reminder notes.
<b>Use</b>	(1) To put into action or service; (2) to avail oneself of; (3) to carry out a purpose or action by means of.
<b>Verify</b>	(1) To confirm or establish that a proper condition exists; (2) to establish the truth or accuracy of.
<b>Wait</b>	To suspend activity in a sequence of activities until a given condition occurs or a given time has elapsed.
<b>Wash</b>	(1) To cleanse by, or as if by, the action of liquid; (2) to remove dirt by rubbing or drenching with liquid.

**Watch** (1) To take note of visually; (2) to pay attention to in order to check on action or change.

**Wire** (1) To provide with wire; (2) to use wire on.

**Withdraw** To take back, away, or out.

**Wrap** To wind, coil, or twine so as to encircle or cover something.

**Zero** To set a device or system to null.

**A**

Abbreviation(s)

equivalence of abbreviated and complete  
 entry ..... 8.1.11.7.5 ..... 8-25  
 formation of ..... 8.3.10.4.9 ..... 8-78  
 in control labels ..... 7.5.5.2 ..... 7-101  
 in displays ..... 8.2.1.4.8 ..... 8-43  
 in labels ..... 6.3.5.4.2 ..... 6-22  
 in a query language .... 8.1.14.5.4 ..... 8-34  
 in selecting menu options  
     8.1.11.7.5 ..... 8-25  
 in text in windows .... 8.3.10.4.8 ..... 8-77  
 in user-computer interactions  
     8.1.7 ..... 8-15  
     characteristics ..... 8.1.7.1 ..... 8-15  
     conformance with standard abbreviations  
         8.1.7.2 ..... 8-15  
     definitions of ..... 8.1.7.3 ..... 8-16  
     rules for new abbreviations  
         8.1.7.4 ..... 8-16  
     use of ..... 8.1.7.2 ..... 8-15  
 in user documentation  
     10.2.4.8 ..... 10-14 - 10-16  
     rules for ..... 10.2.4.8.6 ..... 10-16  
     standard abbreviations  
         10.2.4.8.6 ..... 10-16  
 of commands in command languages  
     8.1.13.10 ..... 8-30  
 on-line dictionary of .. 8.3.10.4.10 ..... 8-78  
 "Abort"  
 untransmitted message  
     8.3.12.5.6 ..... 8-84  
 user interrupt ..... 8.1.4.1, ..... 8-9  
 Acceleration  
     environmental ..... 4.3.2.6 ..... 4-5  
 Accelerators (*see* Keyboard accelerators)  
 Acceptability (*see* User acceptability)  
 Access (*see also* Data access)  
     arm ..... 6.4.3.3 ..... 6-25  
     arm and wrist support  
         7.6.3.9 ..... 7-111  
     control ..... 11.2 ..... 11-3 - 11-4  
     design compatibility to equipment  
         4.3.1.d ..... 4-5  
         6.1.1.1.g ..... 6-2  
         6.3.3.1.3 ..... 6-16  
     finger ..... 6.4.3.2 ..... 6-24  
     hand ..... 6.4.3.3 ..... 6-25  
         6.4.3.4 ..... 6-26  
     infrared ..... 7.6.3.9 ..... 7-111  
     momentary vs continuous  
         7.6.3.5 ..... 7-110  
     physical ..... 6.4.2.1, 6.4.2.3 6-23 - 6-24  
         6.5.4.1 ..... 6-30  
         11.2 ..... 11-3  
     reach ..... 7.6.3.9 ..... 7-111  
     remote control ..... 7.6.3.9 ..... 7-111  
     special controls ..... 7.6.3.8 ..... 7-111  
     speech ..... 7.6.3.9 ..... 7-111  
     system ..... 8.3.9.1.1 ..... 8-69  
 to office equipment  
     by persons with disabilities  
         8.9.1.1 ..... 8-151

to work area ..... 9.3.4.1.1 ..... 9-13  
 unobstructed ..... 7.6.3.4 ..... 7-110  
 unrestrained grasp shape  
     7.6.3.7 ..... 7-111  
 visual ..... 6.5.4.1 ..... 6-30  
     6.4.2.1 ..... 6-23  
     6.4.2.2 ..... 6-24  
     6.3.4.1.1, 6.3.4.1.2 .... 6-17  
     6.3.4.1.5 ..... 6-18  
     6.3.4.1.8 ..... 6-18  
     large-screen displays  
         7.2.5.1.2 ..... 7-28  
 Access control  
     automatic ..... 11.2.3 ..... 11-4  
     log ..... 11.2.5 ..... 11-4  
     setting up ..... 11.3.1.12 ..... 11-7  
     systems ..... 11.2.3, 11.2.5 ..... 11-4  
 Accessibility  
     of connectors ..... 6.8.3 ..... 6-50  
     of critical equipment .. 6.3.4.2.1 ..... 6-18  
     physical ..... 6.3.4.1.1  
         - 6.3.4.1.9 ..... 6-18  
     relative ..... 6.3.4.2 - 6.3.4.2.6 ..... 6-18  
     telephone handsets .... 7.3.5.3.3 ..... 7-50  
     to equipment ..... 6.1.1.1 ..... 6-2  
         6.3.3.1.3 ..... 6-16  
         6.3.4 ..... 6-17  
         12.3.2 ..... 12-5  
     to modules ..... 6.10.2.1.5 ..... 6-73  
     visual ..... 6.3.4.1.1, 6.3.4.1.2 .... 6-17  
         6.3.4.1.5 ..... 6-18  
         7.2.1.6.2 ..... 7-10  
 Access openings ..... 6.4 ..... 6-23 - 6-27  
     accommodation ..... 6.4.3.1 ..... 6-24  
     cover ..... 6.5.7.2 ..... 6-31  
     edges of ..... 6.4.1.3 ..... 6-23  
     labeling and marking of  
         6.4.6 ..... 6-27  
     location of ..... 6.4.5 ..... 6-26 - 6-27  
     nonremoval of components  
         6.4.5.7 ..... 6-27  
     number of ..... 6.4.1.2 ..... 6-23  
     size of ..... 6.4.3 ..... 6-24 - 6-25  
     uncovered ..... 6.4.1.4 ..... 6-23  
     when to provide ..... 6.4.1.1 ..... 6-23  
 Access space, providing in passageway  
     9.3.2.2 ..... 9-10  
 Accessibility ..... 9.7.1 ..... 9-53  
 Accommodating  
     assistive devices ..... 8.9.8 ..... 8-156  
     people with  
         disabilities ..... 4.3.5 ..... 4-5  
             7.6 ..... 7-101 - 7-115  
             8.9 ..... 8-149  
             10.6 ..... 10-66  
         hearing disabilities  
             8.9.6 ..... 8-154  
         moderate disabilities  
             8.9.2 ..... 8-151  
         severe physical disabilities  
             8.9.3 ..... 8-152  
         seizure disorders ... 8.9.7 ..... 8-156  
         visual disabilities .. 8.9.4 ..... 8-153  
     the blind ..... 8.9.5 ..... 8-153

- Accommodation  
 reasonable..... 8.9 ..... 8-149  
 9.7.2 ..... 9-54  
 right- and left-handed people  
 7.1.1.2 ..... 7-1
- Accreditation of automated information systems  
 11.1.4 ..... 11-2
- Acknowledgement  
 alarms ..... 8.1.3.5.3, 8.1.3.5.4 ..... 8-8  
 auditory signals ..... 8.5.4.6.5 ..... 8-107  
 critical alarms ..... 8.1.3.5.4 ..... 8-8  
 flash coding ..... 8.5.4.6.5 ..... 8-107  
 spoken warning signals  
 8.5.9.2.6 ..... 8-124
- Acoustic environment (*see also* Noise, ambient level)  
 compatibility of auditory alarms and signals  
 7.3.2.2.8 ..... 7-44  
 loud, low frequency noise  
 7.3.5.1.3 ..... 7-49  
 signals ..... 8.5.4.3.5 ..... 8-105  
 telephone volume controls  
 7.3.5.5.8 ..... 7-52  
 use of standard signals  
 7.3.2.3.12 ..... 7-46
- Acoustical design ..... 13.5.2.1 ..... 13-16
- Acquisition agency (*see* Acquisition program office)
- Acquisition of new systems and equipment  
 1.3.1 ..... 1-2
- Acquisition policy ..... foreword ..... i  
 1 ..... 1-1
- Acquisition program office agreement  
 testing ..... 4.3.3 ..... 4-5  
 application of this HFDG  
 4 ..... 4-1  
 approval by ..... 6.4.2.3 ..... 6-24  
 6.8.5.2.12 ..... 6-55  
 6.9.1.8.1 ..... 6-65  
 7.1.3.6 ..... 7-5  
 7.2.3.1.1 ..... 7-19  
 7.2.3.3.1 ..... 7-22  
 7.2.4.3.2 ..... 7-24  
 7.5.5.6 ..... 7-101  
 8.8.1.1 ..... 8-139  
 9.3.1.4 ..... 9-9  
 9.3.2.1 ..... 9-10  
 9.3.4.5.1 ..... 9-17  
 9.4.2.1 ..... 9-36  
 12.4.5.2 ..... 12-13  
 12.6.5 ..... 12-16  
 12.8.1 ..... 12-18  
 14.1.1.2 ..... 14-2  
 14.1.4.2 ..... 14-9  
 ADA determination ... 4.2.5 ..... 4-4  
 reviewed by ..... 14.6.5 ..... 14-53  
 test and evaluation by  
 11.3.1.1 ..... 11-5  
 verified by ..... 9.1.1 - 9.1.2 ..... 9-1  
 9.3.2.2 ..... 9-10  
 9.3.2.7 ..... 9-10  
 9.5.4.1 ..... 9-47
- Acronyms  
 formation of ..... 8.3.10.4.9 ..... 8-78  
 in a query language  
 8.1.14.3.3 ..... 8-32  
 in text in windows ..... 8.3.10.4.7 ..... 8-78  
 in user documentation  
 10.2.4.8 ..... 10-14 - 10-16
- on-line dictionary of  
 8.3.10.4.10 ..... 8-78  
 upper-case letters ..... 8.3.10.4.9 ..... 8-78
- Action icons (*see* Icons, action)
- Action level ..... 13.5.1.3 ..... 13-14
- Action voice ..... 10.2.3.6.1 ..... 10-10
- Activation key(s)  
 multiple, simultaneous  
 8.9.2.1 ..... 8-151
- Active window (*see* Window states, active)
- Adapter  
 built-in ..... 6.14.2.12 ..... 6-91  
 plug ..... 6.8.5.1.13 ..... 6-53  
 receptacle ..... 6.8.5.1.13 ..... 6-53
- Additional technical information  
 considerations ..... 5.10 ..... 5-28  
 embedded ..... 5.10.1 ..... 5-28  
 job aids ..... 5.10 ..... 5-28  
 5.10.1 ..... 5-28  
 5.10.2 ..... 5-28  
 on-line information ... 5.10.1 ..... 5-28  
 5.10.2 ..... 5-28  
 5.10.1 ..... 5-28  
 understanding automation  
 5.10.2 ..... 5-28
- Addressing messages (*see* Message(s), addressing)
- Adjustable dimensions, range for  
 14.1.2.8 ..... 14-7
- Adjustment(s)  
 capabilities  
 in workspace design  
 14.6.1 ..... 14-52  
 using design units . 14.6.1 ..... 14-52  
 critical ..... 6.11.18 ..... 6-82  
 equipment ..... 6.3.1.4 ..... 6-16  
 fine ..... 6.11.14 ..... 6-82  
 functionally related ... 6.11.7 ..... 6-81  
 gross ..... 6.11.14 ..... 6-82  
 points ..... 6.10.3.1.11 ..... 6-76  
 sensitive ..... 6.11.18 ..... 6-82  
 6.3.4.1.8 ..... 6-18  
 without flashlights .... 6.11.12 ..... 6-82  
 without mirrors ..... 6.11.12 ..... 6-82
- Adjustment controls (*see* Controls, Adjustment)
- Adjustment points (*see* Service points)
- Advance organizers, when to provide and  
 in this guide ..... 10.2.1.3.1 ..... 10-6
- Advisory messages, unrecognized command  
 8.1.5.3.3 ..... 8-13
- Aids (*see* Automated aids, Computer aids,  
 Decision aids)
- Air  
 discharge  
 cold ..... 13.3.3 ..... 13-6  
 hot ..... 13.3.2 ..... 13-6  
 velocity ..... 13.2.1, 13.2.3 ..... 13-2  
 13.3.1 ..... 13-5  
 quality ..... 9.3.2.6 ..... 9-10  
 Air-exhaust openings ..... 12.5.1.11 ..... 12-15  
 Air Traffic ..... 5 ..... 5-1  
 Aisles, marking ..... 9.2.1.12 ..... 9-4
- Alarm(s)  
 annotation to transmitted data  
 8.7.1.7 ..... 8-130



Alarm(s) (continued)		
auditory .....	6.12.1.2, 6.12.1.3 .....	6-82
auditory and ambient noise	7.3.2.3.1 .....	7-45
auditory coding .....	7.3.2.3.9 .....	7-46
automatic clearing .....	7.2.1.5.11 .....	7-10
characteristics .....	5.7.10 .....	5-22
confidence .....	5.7.10 .....	5-22
definition .....	5.7.9.e .....	5-21
differentiation from routine signals	7.3.2.3.10 .....	7-46
disabled .....	12.2.1.3 .....	12-1
disabled persons .....	12.2.1.3 .....	12-1
displays .....	5.7,13 .....	5-24
employee engineering	12.2.1, 12.2.1.1 .....	12-1
evaluation .....	5.7.10 .....	5-22
failure .....	5.7.4 .....	5-24
false .....	7.3.1.4 .....	7-42
rate .....	11.2.4 .....	11-4
rate .....	5.7.11 .....	5-23
feedback, timely .....	5.7.10 .....	5-23
filtered .....	5.7.12 .....	5-23
fire .....	6.12.1.1 .....	6-83
12.2.1, 12.2.1.1 .....	12-1	
for changes in security levels	11.5.2.1 .....	11-10
for degraded system ..	11.5.1.5 .....	11-10
for remote facilities ..	11.2.4 .....	11-4
for security failure .....	11.1.7 .....	11-3
for threats to security ..	11.5.1.3 .....	11-9
in human-computer interfaces	8.1.3.5 .....	8-8 - 8-9
acknowledging .....	8.1.3.5.2 .....	8-8
consistent .....	8.1.3.5.4 .....	8-8
critical alarms .....	8.1.3.5.1 .....	8-8
distinctive .....	8.1.3.5.3 .....	8-8
feedback .....	8.1.3.5.1 .....	8-8
parameter setting by user	8.1.3.5.3 .....	8-8
reset .....	8.1.3.5.6 .....	8-9
terminating .....	8.1.3.5.5 .....	8-8
terminating .....	8.1.3.5.2 .....	8-8
location .....	7.2.1.5.3 .....	7-9
loss of redundancy .....	6.12.1.4 .....	6-82
out-of-service .....	7.2.1.5.2 .....	7-9
parameter selection .....	7.2.1.5.2 .....	7-9
prioritization .....	7.2.1.5.4 - 7.2.1.5.7 .....	7-9
priority levels .....	5.2.10 .....	5-22
processing and aiding .....	5.7.12 .....	5-23
soft alarms .....	5.7.10 .....	5-22
status and diagnosis ..	5.7.9 .....	5-21
testing .....	7.2.1.5.13 .....	7-10
use .....	6.12.1 .....	6-83
visual .....	6.12.12, 6.12.1.3 .....	6-83
Alert(ing)		
annotation to transmitted data	8.7.1.7 .....	8-130
capacity, auditory signals	7.3.2.3.3 .....	7-45
characteristics .....	5.7.10 .....	5-22
confidence .....	5.7.10 .....	5-22
definitions .....	5.79 .....	5-21
displays .....	7.2.1.5.1 .....	7-9
evaluation .....	5.7.10 .....	5-22
monitoring .....	5.76 .....	5-20
5.7.10 .....	5-22	
priorities .....	5.7.10 .....	5-22
signals .....	8.5.9.2.5 .....	8-124
auditory warnings ..	7.3.2.2.1, 7.3.2.2.2 .....	7-44
onset .....	7.3.2.3.4 .....	7-45
verbal warnings .....	7.3.3.1 .....	7-46
status and diagnosis ..	5.7.9 .....	5-21
user to critical changes	7.2.1.1.11 .....	7-7
Alignment		
aids .....	6.2.8 .....	6-12
6.2.9.1 .....	6-13	
6.8.4 .....	6-51	
before contact .....	6.8.4.2 .....	6-51
6.8.5.1.3 .....	6-52	
coding .....	6.8.4.4 .....	6-51
for drawer connector ..	6.8.4.5 .....	6-51
guides .....	6.8.5.1.15 .....	6-53
orientation .....	6.8.4.1 .....	6-51
relevant position .....	6.8.4.3 .....	6-51
Allocation of functions		
analysis .....	5.2.11 .....	5-7
to humans .....	5.2.9 .....	5-6
Alphanumeric		
characters in CRT displays	7.2.4.6 .....	7-26 - 7-27
data, update rate .....	8.5.7.1.3 .....	8-117
designation of parts .....	6.10.5.15 .....	6-80
justification of entries		
fields in forms .....	8.4.3.7.3.a .....	8-96
tables in displays ..	8.4.5.4 .....	8-98
keyboards .....	7.4.4.9.3 .....	7-78
labels in displays .....	8.5.2.2.2 .....	8-103
Alphanumeric coding .....	8.5.4.2 .....	8-104
in displays		
case of letters .....	8.5.4.2.2 .....	8-104
length of codes .....	8.5.4.2.4 .....	8-105
mixed letters and numbers	8.5.4.2.3 .....	8-104
supplemental use only	8.5.4.2.1 .....	8-104
8.3.7.2.4 .....	8-66	
"Alt" key		
assigning input focus ..	8.3.4.3.4 .....	8-60
navigation to menu bar	8.3.2.4.1 .....	8-56
Ambient illumination .....	7.2.4.3 .....	7-24
and color in displays ..	8.2.4.1.14 .....	8-52
color saturation, CRT displays	7.2.4.2.2 .....	7-23
control color coding ..	7.4.1.4.8 .....	7-61
control label characters	7.5.4.1 .....	7-100
7.5.4.2 .....	7-100	
control labeling .....	7.5.3.2 .....	7-99
7.5.3.3 .....	7-99	
CRT displays		
adjacent surface luminance	7.2.4.3.3 .....	7-24
ambient illuminance	7.2.4.3.4 .....	7-24
dark characters, light background	7.2.4.3.5 .....	7-25
7.2.4.6.4 .....	7-27	
faint signal detection	7.2.4.3.2 .....	7-24
illuminance controls ..	7.2.4.3.4 .....	7-24

- Ambient illumination (continued)  
 key-operated switch color coding  
     7.4.4.2.2 ..... 7-67  
 large-screen displays . 7.2.5.2.1, 7.2.5.2.4 .... 7-30  
 rocker switches ..... 7.4.4.12.7 ..... 7-83  
 thumbwheels ..... 7.4.4.3.5 ..... 7-69  
     7.4.4.3.6 ..... 7-69  
 transilluminated displays  
     7.2.2.1.9, 7.2.2.1.10 ... 7-14
- Ambient light and dark adaptation  
     13.4.3.3 ..... 13-11
- Ambient noise areas  
 equipment ..... 12.12.6 ..... 12-22  
     13.5.2.8 ..... 13-17  
 extreme quiet ..... 12.12.3 ..... 12-22  
     13.5.2.5 ..... 13-16  
 operational ..... 12.12.5 ..... 12-22  
     13.5.2.7 ..... 13-17  
 small office ..... 12.12.4 ..... 12-22  
     13.5.2.6 ..... 13-16  
 special ..... 12.12.4 ..... 12-22  
     13.5.2.6 ..... 13-16
- Ambient noise level (*see also* Noise, ambient level)
- Americans with Disabilities Act of 1990  
     4.2.5 ..... 4-4  
     8.9 ..... 8-149  
     10.6 ..... 10-66  
 28 CFR 35.104 ..... 4.3.5 ..... 4-3  
 28 CFR 36.104 ..... 4.3.5 ..... 4-3  
 29 CFR 1630.2 ..... 4.3.5 ..... 4-3
- "And" (in data base queries)  
     8.1.14.1.7 ..... 8-31
- Analytic tools (*see also* models)  
 acceptability to user ... 5.6.3 ..... 5-17  
 diagnostic ..... 5.7.7 ..... 5-21  
 for human performance  
     5.1 ..... 5-1  
 task ..... 5.7.7 ..... 5-21
- Anchors for platforms ..... 12.2.2.2 ..... 12-3
- Angle of incidence ..... 13.4.5.3 ..... 13-12
- Annotations  
 incoming messages .... 8.7.6.3.5 ..... 8-135  
 material in plotters or recorders  
     7.2.9.3.7 ..... 7-41  
 material in printers .... 7.2.9.2.5 ..... 7-40  
 on-line help ..... 8.6.1.1.12 ..... 8-127
- Anthropometric  
 data ..... 14.3 ..... 14-16 - 14-36  
     application of ..... 14.1 ..... 14-1 - 14-15  
     dynamic ..... 14.3.3.2.4 ..... 14-36  
     in this HFDG ..... 14.1.1.2 ..... 14-2  
     pitfalls in applying  
         14.1.3 ..... 14-8  
         14.1.6.2 ..... 14-15  
         14.3.3.2.4 ..... 14-36  
     range values ..... 14.1.1.3 ..... 14-2  
     relevant ..... 14.3.2.2 ..... 14-17  
     use ..... 14.1.1.1 ..... 14-2  
     variability factors ..... 14.2 ..... 14-15 - 14-16
- Anthropometry ..... 14 ..... 14-1 - 14-53  
 in the workplace ..... 9.1.2 ..... 9-1
- Appendixes (in user documentation)  
     10.4.9 ..... 10-43 - 10-44  
 identification ..... 10.4.9.3 ..... 10-43  
 location ..... 10.4.9.4 ..... 10-43  
 page numbering ..... 10.4.9.5 ..... 10-43  
 relation to main body . 10.4.9.2 ..... 10-43  
     right-hand page ..... 10.4.9.6 ..... 10-44  
     title ..... 10.4.9.6 ..... 10-44  
     when to use ..... 10.4.9.1 ..... 10-43
- Applicability  
 criteria and guidelines  
     4 ..... 4-1  
 commercial off-the-shelf equipment  
     1.3.2.5 ..... 1-2  
 modified systems ..... 1 ..... 1-1  
 new systems ..... 1 ..... 1-1  
 of this HFDG ..... 1 ..... 1-1  
 updated systems ..... 1 ..... 1-1
- Applicable documents (See complementary documents) ..... 2 ..... 2-1
- Application  
 selective ..... 1.3.1 ..... 1-2
- Application-level windows (*see* Windows, application-level)
- "Apply" push button  
 in data entry windows  
     8.3.12.2.11 ..... 8-82  
 in request message windows  
     8.3.10.2.6 ..... 8-75
- Aprons ..... 12.9.1 ..... 12-18
- Aptitude profile (of document users)  
     10.1.1.1 ..... 10-2
- Arabic numerals ..... 10.2.4.10.2 ..... 10-17  
 in windows ..... 8.3.10.4.5 ..... 8-77  
 page numbering ..... 10.3.2.6.1 ..... 10-24
- Areas  
 high noise ..... 12.12.7 ..... 12-22  
     13.5.2.9 ..... 13-17  
 in graphic data displays  
     8.5.5.7 ..... 8-113  
     between curves .... 8.5.5.7.1 ..... 8-113  
     color coding ..... 8.5.5.4.3 ..... 8-110  
     filling ..... 8.5.5.3.15 ..... 8-110  
     labeling ..... 8.5.5.7.3 ..... 8-113  
     pattern curves ..... 8.5.5.4.3 ..... 8-110  
     stacked curves .... 8.5.5.7.2 ..... 8-113  
 in maps, coding of .... 8.5.8.1.9 ..... 8-119
- Arrangement of equipment  
     6.3 ..... 6-13 - 6-23
- Arrow(s)  
 as symbols ..... 8.5.4.8.2 ..... 8-107  
 distinguishing mark for menu options  
     8.3.7.3.5.c ..... 8-67  
 in labels ..... 6.3.5.5.3 ..... 6-20
- Articulation index ..... 7.3.5.6.1.c ..... 7-53
- Artificial illumination, environmental  
     4.3.2.c ..... 4-3
- Artificial intelligence  
 aids ..... 5.3.3 f ..... 5-11  
 automation, human centered  
     5.2 ..... 5-4  
 not off-the-shelf ..... 5.3.3 f ..... 5-11  
 supervisory control .... 5.2 ..... 5-9
- Asbestos ..... 12.7.6 ..... 12-18
- ASCII format ..... 10.6.2 ..... 10-66
- Assembly, ease of ..... 6.1.1.1 ..... 6-2
- Asterisks as symbols ..... 8.5.4.8.2 ..... 8-107
- AT and AF modernization  
     5 ..... 5-1

Audibility	
minimum volume setting	
headsets ..... 7.3.5.4.1	7-51
loud speakers ..... 7.3.5.4.1	7-51
warning signals ..... 7.3.4.2.1, 7.3.4.2.4	7-48
Audio displays (see also Warnings and signals, auditory; Warnings, verbal)	
7.3	7-42 - 7-53
accompanying visual signal	
7.3.1.7	7-43
complex sounds ..... 7.3.1.3	7-42
false alarms ..... 7.3.1.4	7-42
signal type ..... 7.3.1.3	7-42
single audio display for multiple visual displays	
7.3.1.1	7-42
speech ..... 7.3.1.3	7-42
system or equipment failure	
7.3.1.6	7-42
testing operation ..... 7.3.1.6	7-42
tones ..... 7.3.1.3	7-42
when to use ..... 7.3.1.2	7-42
Audiometric testing ..... 13.5.1.5	13-15
Audio warning devices	
audibility ..... 7.3.4.2.1, 7.3.4.2.2	7-48
controls ..... 7.3.4	7-47
shutoff, automatic . 7.3.4.1.1	7-47
7.3.4.2.4	7-48
shutoff, manual .... 7.3.4.1.1	7-47
7.3.4.2.5	7-48
reset, automatic .... 7.3.4.1.2	7-48
reset, manual ..... 7.3.4.2.3	7-48
volume ..... 7.3.4.2.1 - 7.3.4.2.3	7-48
volume ganged to mode switch	
7.3.4.2.2	7-48
signal duration ..... 7.3.4.2.4	7-48
7.3.4.2.5	7-48
volume limits ..... 7.3.4.2.1	7-48
Audit(ing) ..... 11.4	11-9
events ..... 11.4.3	11-9
programs ..... 11.4.3	11-9
reducing, data ..... 11.4.2	11-9
security levels ..... 11.4.4	11-9
specific users ..... 11.4.4	11-9
Auditory	
counterparts ..... 8.9.6.2.4	8-155
information ..... 8.9.6.1.2.i	8-155
outputs ..... 7.6.2.1	7-105
7.6.2.2	7-106
representation ..... 8.9.6.2	8-155 - 8-156
navigation in ..... 8.9.6.2.2	8-155
of buttons ..... 8.9.6.2.5.d	8-156
of dialogues ..... 8.9.6.2.5.c	8-156
of menus ..... 8.9.6.2.5.a	8-156
of scroll bars ..... 8.9.6.2.5.e	8-156
of windows ..... 8.9.6.2.5.b	8-156
Auditory coding ..... 8.5.4.3	8-105
accompanying visual coding	
7.2.1.5.7	7-9
acknowledgement ..... 8.5.4.3.1	8-105
appropriate use ..... 8.5.4.3	8-105
delayed computer response	
8.5.4.3.3	8-105
distinguishable and intermittent	
8.5.4.3.4	8-105
environmental compatibility	
8.5.4.3.5	8-105
in widows ..... 8.2.1.11.3	8-46
user control ..... 8.5.4.3.2	8-105
warning signals ..... 7.3.2.3.9	7-42
Auditory signals (see also Audio displays)	
accompanying warning message windows	
8.3.9.1.6	8-70
automatic log off notification	
8.3.9.1.6	8-70
Authentication ..... 11.3	11-4 - 11-9
additional ..... 11.3.1.11	11-7
changing ..... 11.3.1.1	11-5
in log on ..... 8.2.2.2.2	8-47
inputting, information . 11.3.1.8, 11.3.1.9	11-5
tasks ..... 11.3.1.2	11-5
technologies ..... 11.3.3	11-8
through "hand shaking"	
11.3.1.11	11-7
Authorization	
changing ..... 11.3.1.1	11-5
throughout a work session	
11.3.1.13	11-7
Automate (see Automation)	
Automated aids for analyzing images	
8.5.5.10.1	8-114
Automated decision aid (see Decision aid)	
Automated information systems	
11	11-1
accreditation of ..... 11.1.4	11-2
certification of ..... 11.1.4	11-2
Automatic entry of data on related screens	
8.5.1.1	8-101
Automatic test equipment	
advantages ..... 6.15.4	6-99
disadvantages ..... 6.15.4	6-99
Automation (see also Maintenance automation)	
as a resource ..... 5.2	5-4
as a team player ..... 5.2.3	5-5
back up for ..... 5.2.13	5-7
comprehensible ..... 5.2.18	5-8
control actions	
control(s) ..... 5.2.16	5-7
5.2.14	5-7
5.2.1	5-7
confirmation, override	
5.2.14	5-7
inform human of failure	
5.2.14	5-7
out of tolerance failures	
5.2.14	5-7
cost effectiveness ..... 5.2.10	5-6
definition ..... 5.2	5-3
discussion ..... 5.2	5-3
functions ..... 5.3.6	5-12
human-centered (see human-centered automation)	
human role ..... 5.2	5-3
5.2.1	5-4
human like tasks ..... 5.2.5	5-5
human understanding . 5.3.6	5-12
maintenance concepts 5	5-1
mental models ..... 5.3.6	5-12
mode compatibility .... 5.2.18	5-8
monitoring automation	
5.2.7	5-6
monitoring humans .... 5.2.8	5-6
negative aspects ..... 5.2	5-3
critical error and poor decisions	
5.2.6	5-5

- Automation (continued)
- too much information
    - 5.2.7 ..... 5-5
  - silent, passive failure
    - 5.2.15 ..... 5-7
  - normal, degraded modes
    - 5.2.3 ..... 5-5
  - with good reason ..... 5.2.9 ..... 5-6
    - technical feasibility insufficient
      - 5.2.8 ..... 5-6
    - predictable ..... 5.2.6 ..... 5-5
    - of fault detection ..... 6.1.2.4 ..... 6-3
    - programs ..... 5 ..... 5-1
    - transparent to user .... 5.4.5 ..... 5-16
    - training ..... 5.10.5 ..... 5-29
  - Availability, NAS components
    - NAS goal ..... 5.1.1.1 ..... 5-2
    - objective of modernization
      - 5 ..... 5-2
  - "Average" person, misuse of
    - 14.1.3.2 ..... 14-8
  - A-weighted sound level (dB(A))
    - 12.12 ..... 12-21
    - 12.12.2 ..... 12-21
    - 13.5.2.4 ..... 13-16
  - Axis(es)
    - in graphic data display
      - breaks ..... 8.5.5.4.5 ..... 8-111
      - duplication ..... 8.5.5.4.6 ..... 8-111
      - labeling ..... 8.5.5.4.10 ..... 8-111
      - one axis per scale .... 8.5.5.4.9 ..... 8-111
- B**
- Background-foreground contrast
    - alphanumeric characters
      - 7.2.4.3.5 ..... 7-25
      - 7.2.6.4 ..... 7-32
    - pictorial and graphic data
      - 7.2.4.7.1 ..... 7-27
    - superimposed images in optical projection
      - 7.2.5.2.9 ..... 7-31
  - Background noise (*see* Noise, background)
  - Backspace key, action in text entry
    - 8.4.2.2.2 ..... 8-90
    - 8.3.8.6 ..... 8-69
  - Backup (See also Modes of operation)
    - communications subsystems
      - 5.4.4 ..... 5-15
    - for automation ..... 5.2.1.3 ..... 5-7
    - rerouted, human interfaces
      - 5.4.8 ..... 5-16
    - voice communications
      - 5.6.1 ..... 5-18
  - "Backup"
    - in editing forms ..... 8.4.3.7.4 ..... 8-97
    - user interrupt ..... 8.1.4.1, 8.1.4.3 ..... 8-9
  - Ball controls ..... 7.4.4.22 ..... 7-93 - 7-94
    - 8.8.3.3 ..... 8-142
    - activation ..... 8.8.3.3.2 ..... 8-143
    - conformance ..... 8.8.3.3.1 ..... 8-143
    - deactivation ..... 8.8.3.3.2 ..... 8-143
    - limb support ..... 7.4.4.22.2 ..... 7-93
    - movement characteristics
      - 7.4.4.22.3 ..... 7-93
    - movement of a follower off a display
      - 7.4.4.22.5 ..... 7-94
    - specifications ..... 7.4.4.22.1 ..... 7-93
    - use of ..... 8.8.3.3.1 ..... 8-143
    - when to use ..... 7.4.4.22.4 ..... 7-94
  - Ball tracker (*see* Ball controls)
  - Barriers
    - for legend switches ... 7.4.4.11.2 ..... 7-81
    - for rocker switches .... 7.4.4.12.4 ..... 7-82
    - for slide switches ..... 7.4.4.13.2 ..... 7-85
  - Battery(ies)
    - service facilities ..... 12.7.4 ..... 12-17
    - 12.9.3, 12.9.4 ..... 12-19
  - Bench mockup(s) ..... 6.15.6 ..... 6-100 - 6-101
    - accessibility ..... 6.15.6.10 ..... 6-101
    - covers for ..... 6.15.6.9 ..... 6-101
    - design ..... 6.15.1.1.1 ..... 6-95
    - extension cables for .. 6.15.6.3 ..... 6-100
    - instructions for ..... 6.15.6.8 ..... 6-101
    - space for ..... 6.16.6.1 ..... 6-100
  - Bench mock-up cable ..... 6.9.1.7 ..... 6-65
    - connectors for ..... 6.9.1.7.2 ..... 6-65
    - 6.15.6.4 ..... 6-100
    - coverings for ..... 6.9.1.7.3, 6.15.6.5 ..... 6-65
    - test points ..... 6.9.1.7.4, 6.15.6.6 ..... 6-65
  - Binding (a document) ..... 10.3.1.2 ..... 10-19 - 10-20
    - comb ..... 10.3.1.2.2 ..... 10-20
    - easy updating ..... 10.3.1.2.3 ..... 10-20
    - mechanical ..... 10.3.1.2 ..... 10-20
    - page offset ..... 10.3.2.1.4 ..... 10-21
    - page orientation ..... 10.3.1.2.1 ..... 10-20
    - pamphlet ..... 10.3.1.2 ..... 10-20
    - perfect ..... 10.3.1.2 ..... 10-20
    - ring ..... 10.3.1.2.2 ..... 10-20
    - 10.3.1.2.3 ..... 10-20
    - saddle-stitched ..... 10.3.1.2 ..... 10-20
    - 10.3.1.2.2 ..... 10-20
    - spiral ..... 10.3.1.2.2 ..... 10-20
  - Binaural headsets (*see* Dichotic presentation; Headsets, binaural)
  - Biomechanics data ..... 14.3 ..... 14-16 - 14-36
    - application of ..... 14.1 ..... 14-1 - 14-15
    - dynamic ..... 14.3.3.2.4 ..... 14-36
    - in this HFDG ..... 14.1.1.2 ..... 14-2
    - range values ..... 14.1.1.3 ..... 14-2
    - use ..... 14.1.1.1 ..... 14-2
  - Biomechanics ..... 14 ..... 14-1 - 14-53
  - Bivariate data (*see* Data, bivariate)
  - Black, in controls ..... 7.4.1.4.5 ..... 7-61
  - Blank space (*sees also* White space)
    - in data displays ..... 8.5.1.12 ..... 8-102
    - separating grouped data
      - 8.5.1.13 ..... 8-102
    - separating labels and titles from body of a display
      - 8.5.2.2.4 ..... 8-104
  - Blast, environmental ..... 4.2.2.b ..... 4-3
  - Bleeder(s) (*see* Discharging devices, bleeders)
  - Bleeder networks ..... 6.10.3.3.5 ..... 6-76
    - 12.4.3.1 ..... 12-10
  - Blind operation of controls
    - 7.4.1.5.3 ..... 7-62
  - Block diagrams (in user documentation)
    - 10.4.4.5.3 ..... 10-39
  - on text panels ..... 6.15.2.4.3 ..... 6-99
  - Blue
    - coding in CRT displays
      - 7.2.4.2.3 ..... 7-23
    - color combinations ... 8.2.4.1.23 ..... 8-53
    - comparisons ..... 8.2.4.1.23 ..... 8-53

Blue (continued)

- dot matrix emitters ... 7.2.6.5 ..... 7-32
- in controls ..... 7.4.1.4.5 ..... 7-61
- in displays ..... 8.2.4.1.22 ..... 8-53
- reserved meaning in displays
  - 8.5.4.5.1.f ..... 8-106
- use in CRT displays .. 7.2.4.2.4 ..... 7-24

Body measurements ..... 14.1.5.3 ..... 14-14

Body motions ..... 14.3.3.1 ..... 14-30 - 14-31

- based on task ..... 14.1.4.1 ..... 14-9

Body positions

- avoiding awkward .... 6.4.5.4 ..... 6-27
- awkward ..... 14.6.4 ..... 14-53
- based on task ..... 14.1.4.1 ..... 14-9
- determining ..... 14.2.3 ..... 14-15
- during maintenance tasks
  - 14.3.1.2 ..... 14-16
- during operations tasks
  - 14.3.1.2 ..... 14-16
- for maximum force ... 14.5.3.1 ..... 14-47 - 14-48
- for task considerations
  - 14.4.1 ..... 14-36
- space to move ..... 14.3.3.1.2 ..... 14-31

Body slump ..... 14.2.3 ..... 14-15

Bolts

- coding ..... 6.7.3.1.6 ..... 6-41
- combination-head .... 6.7.3.3.2 ..... 6-42
- exposed threads ..... 12.5.1.10 ..... 12-15
- heads ..... 6.7.3.3 ..... 6-42 - 6-43
- left-handed ..... 6.7.3.1.6 ..... 6-41
- length ..... 6.7.3.1.1 ..... 6-41
- mounting ..... 6.7.3.7.6 ..... 6-46
- 6.7.4.1 ..... 6-47
- 6.7.3.1.8, 6.7.3.1.9 .... 6-41
- threads ..... 6.7.3.1.2 ..... 6-41
- tightening ..... 6.7.3.1.3 ..... 6-41
- selection ..... 6.7.3.6.5 ..... 6-46

Box, text cursor in replace mode

- 8.4.2.4.1 ..... 8-91
- 8.3.8.1 ..... 8-68

Border, window ..... 8.3.2.3 ..... 8-56

Braces ..... 6.3.3.1.3 ..... 6-16

- 6.10.4.4 ..... 6-77

Brackets ..... 6.10.4.5 ..... 6-77

Braille display devices .... 8.9.5.1 ..... 8-153

- 8.9.8.1 ..... 8-156
- 10.6.1 ..... 10-66

Brightness coding (in displays)

- 8.5.4.4 ..... 8-105
- brightness ratios ..... 8.5.4.4.3 ..... 8-105
- consistent meaning ... 8.5.4.4.1 ..... 8-105
- number of levels ..... 8.5.4.4.2 ..... 8-105

Brightness ratio ..... 13.4.6 ..... 13-12

- 13.4.6.3 ..... 13-12

"Browse" (query language operation)

- 8.9.2.5.6 a ..... 8-156

Browsing

- on-line help ..... 8.6.1.1.11 ..... 8-126

Building maintenance platforms

- 9.3.3.1 ..... 9-11

Built-in indicators ..... 6.14.2.8 ..... 6-91

Built-in test equipment ... 6.15.2 ..... 6-97 - 6-99

- advantages ..... 6.15.2 ..... 6-97
- completely built in ... 6.15.2.1 ..... 6-97
- disadvantages ..... 6.15.2 ..... 6-97
- fault detection ability 6.12.3.8 ..... 6-84
- fault isolation ability . 6.12.3.8 ..... 6-84

- partially built in ..... 6.15.2.2 ..... 6-98

Bumpers

- on equipment ..... 9.3.3.1.3 ..... 9-11

Button operations

- pointing device ..... 8.8.3.7 ..... 8-146
- click ..... 8.8.3.7.1.c ..... 8-146
- double click ..... 8.8.3.7.1.d ..... 8-146
- drag ..... 8.8.3.7.1.e ..... 8-146
- move ..... 8.8.3.7.1.f ..... 8-146
- press ..... 8.8.3.7.1.a ..... 8-146
- release ..... 8.8.3.7.1.b ..... 8-146

Button sets (see also Push buttons)

- 8.1.15.3 ..... 8-38 - 8-39
- 8.1.15.4 ..... 8-39

exclusive

- highlighting selected button
  - 8.1.15.3.3 ..... 8-38
- selection ..... 8.1.15.3.2 ..... 8-38
- 8.2.1.8.2 ..... 8-44
- 8.2.1.8.3 ..... 8-44
- when to use ..... 8.1.15.3.1 ..... 8-38
- 8.2.1.8.2 ..... 8-44
- 8.2.1.8.3 ..... 8-44

nonexclusive

- selection ..... 8.1.15.4.2 ..... 8-39
- states ..... 8.1.15.4.2 ..... 8-39
- when to use ..... 8.1.15.4.1 ..... 8-39
- 8.2.1.8.3 ..... 8-44
- 8.2.1.8.2 ..... 8-44

Bypassing user guidance by experienced users

- 8.6.1.1.9 ..... 8-126

C

Cable(s) (see also Bench Mock-up cables, Extension cables, Line cables, Test cables)

- 6.9 ..... 6-57 - 6-71
- accessibility ..... 6.9.1.3.8, 6.9.1.3.9 .... 6-62
- adequate slack ..... 6.9.1.2.6 ..... 6-60
- design ..... 6.9.1.1.3 ..... 6-58
- distance to ground .... 6.9.1.3.5 ..... 6-62
- exposed ..... 6.9.1.1.9 ..... 6-59
- extra ..... 6.9.1.2.2 ..... 6-60
- "fan-out" ..... 6.8.5.2.3 ..... 6-54
- 6.9.1.1.5 ..... 6-58
- 6.14.2.13 ..... 6-91
- labeling ..... 6.9.1.8.1 ..... 6-65
- 6.9.1.8.2 ..... 6-65
- length of ..... 6.9.1.2.1, 6.9.1.2.3 .... 6-60
- 6.9.1.2.4 ..... 6-60
- lightly insulated ..... 6.9.1.3.5 ..... 6-62
- location ..... 6.10.3.1.11 ..... 6-76
- mounting ..... 6.9.1.1.1 ..... 6-58
- performed ..... 6.9.1.1.6 ..... 6-58
- protection ..... 6.9.1.1.11 ..... 6-59
- 6.9.1.1.12 ..... 6-59
- routing ..... 6.9.1.1.1 ..... 6-57
- 6.9.1.3 ..... 6-61 - 6-62
- selection ..... 6.9.1.1.1 ..... 6-58
- shields ..... 12.4.4.11 ..... 12-12
- special purpose ..... 6.9.1.1.10 ..... 6-59
- support ..... 6.9.1.5.5 ..... 6-63
- terminating ..... 6.9.1.3.14 ..... 6-62

Cable winder ..... 6.9.1.1.13 ..... 6-59

- 6.9.1.6.5 ..... 6-64

Cabling diagrams (in user documentation)

- 10.4.4.5.3 ..... 10-37

- Cadmium oxide fumes  
 exposure to ..... 12.7.3 ..... 12-17
- Cages on ladders, dimensions  
 9.3.5.6.2 ..... 9-25
- Cancel  
 an action ..... 8.1.1.17 ..... 8-3  
 untransmitted message  
 8.3.12.5.6 ..... 8-84
- "Cancel"  
 in editing forms ..... 8.4.3.7.4 ..... 8-97  
 push button  
 in confirmation message windows  
 8.3.10.2.10 ..... 8-76  
 in error message windows  
 8.3.10.2.7 ..... 8-76  
 in request message windows  
 8.3.10.2.7 ..... 8-76  
 in warning message windows  
 8.3.10.2.11 ..... 8-76  
 in "working" message windows  
 8.3.10.2.13 ..... 8-76  
 user interrupt ..... 8.1.4.1, 8.1.4.4 ..... 8-9
- Caps  
 attached to equipment  
 6.5.1.9 ..... 6-29  
 6.7.3.7.5 ..... 6-46  
 easy opening and closing  
 6.5.6.4 ..... 6-31  
 for access ..... 6.5 ..... 6-28  
 nonbinding ..... 6.5.6.3 ..... 6-31  
 positive locking ..... 6.5.6.2 ..... 6-31  
 safe operation ..... 6.5.6.1 ..... 6-31
- Capitalization (*see also* Case (of letters in text))  
 10.2.3.10.1 ..... 10-11  
 as a typographic cue ..... 10.3.3 ..... 10-26  
 for emphasis ..... 8.2.3.2 ..... 8-48  
 8.2.1.11.1 ..... 8-45  
 10.2.3.10.2 ..... 10-11  
 guide ..... 8.2.3.1 ..... 8-48  
 of text in windows ..... 8.3.10.4.6 ..... 8-78
- Captive fastener(s) ..... 6.7.3.7 ..... 6-46  
 operation ..... 6.7.3.7.2 ..... 6-46  
 "quarter-turn" ..... 6.7.3.7.3 ..... 6-46  
 replacement ..... 6.7.3.7.3 ..... 6-46  
 use ..... 6.7.3.7.1, 6.7.3.7.4 ..... 6-46
- Carbon monoxide, exposure to  
 12.7.2 ..... 12-17
- Carcinogens, use of ..... 12.9.7 ..... 12-19
- Carry(ied) (*see also* Lift)  
 by more than one person  
 6.3.5.1.3 ..... 6-20
- Carrying  
 added clearance for equipment  
 9.3.1.2 ..... 9-8  
 by more than one person  
 6.2.2.6, 6.2.2.7 ..... 6-7  
 by one person ..... 6.2.2.5 ..... 6-7
- Carts  
 use of ..... 6.4.5.6 ..... 6-27
- Case(s), equipment ..... 6.6 ..... 6-34 - 6-37  
 corners ..... 6.6.1.7 ..... 6-35  
 design ..... 6.6.1.1 ..... 6-34  
 6.6.1.3, 6.6.1.5 ..... 6-34  
 edges ..... 6.6.1.7 ..... 6-35  
 fastened indicator ..... 6.6.3.5 ..... 6-35  
 grasping areas ..... 6.6.1.6 ..... 6-35  
 handles ..... 6.6.1.6 ..... 6-35  
 on protrusions ..... 12.5.1.1 ..... 12-13  
 removal ..... 6.4.1.1 ..... 6-23  
 6.6.1.2 ..... 6-34  
 removal of ..... 6.6.1.2 ..... 6-34  
 replacement ..... 6.6.1.2 ..... 6-34  
 size of ..... 6.6.2 ..... 6-35
- Case (of letters) (*see also* Capitalization, Visual coding)  
 6.3.5.3.8 ..... 6-21  
 10.3.3.6 ..... 10-28  
 alphanumeric coding ..... 8.5.4.2.2 ..... 8-104  
 conversion ..... 8.3.10.4.7 ..... 8-78  
 emphasis (*see* Capitalization)  
 equivalence of upper and lower case  
 8.1.1.16 ..... 8-3  
 8.3.10.4.17 ..... 8-78  
 in acronyms ..... 8.3.10.4.7 ..... 8-78  
 in application-level window titles  
 8.3.10.1.2 ..... 8-73  
 in character string search  
 8.4.2.2.4 ..... 8-90  
 in control labels ..... 7.5.3.9 ..... 7-100  
 in keyboard accelerators  
 8.3.7.2.7 ..... 8-66  
 in mnemonic codes ..... 8.3.7.2.7 ..... 8-66  
 upper  
 minimize use ..... 10.3.3.6.3 ..... 10-29  
 when to use ..... 10.3.3.6.1 ..... 10-29  
 words in upper case  
 10.3.3.6.2 ..... 10-29  
 mixed ..... 8.2.3.2 ..... 8-48  
 text in windows ..... 8.3.10.4.7 ..... 8-78  
 10.3.3.6 ..... 10-28
- Casual users, needs for user guidance  
 8.6.c ..... 8-125
- Catch(es) (*see* Latches)
- Cathode ray tube (*see also* CRT)  
 cover ..... 12.13.2 ..... 12-23  
 handling ..... 12.13.2 ..... 12-23  
 shielding ..... 12.13.1 ..... 12-23  
 terminal end ..... 12.13.2 ..... 12-23  
 warning ..... 12.13.2 ..... 12-23
- Cathode ray tube displays (*see* CRT displays)
- Catwalk(s) ..... 9.3.2 ..... 9-9  
 approval for ..... 9.3.2.1 ..... 9-10  
 entrances to ..... 9.3.2.4 ..... 9-10  
 guardrails for ..... 9.3.2.3 ..... 9-10  
 handholds on ..... 9.3.2.3 ..... 9-10  
 handrails ..... 9.3.2.3 ..... 9-10  
 nonskid material on ..... 12.2.1.7 ..... 12-2  
 ventilation ..... 9.3.2.6 ..... 9-10  
 width ..... 9.3.2.5 ..... 9-10
- Caution(s) (in user documentation)  
 10.4.8 ..... 10-42 - 10-43  
 contents ..... 10.4.8.3 ..... 10-42  
 no procedural steps ..... 10.4.8.6 ..... 10-43  
 precedence ..... 10.4.8.5 ..... 10-43  
 when to use ..... 10.4.8.1 ..... 10-42
- Caution labels  
 on modules ..... 6.10.5.16 ..... 6-79  
 on parts ..... 6.10.5.16 ..... 6-79
- Caution signals distinct from warning signals  
 7.3.2.2.4 ..... 7-44
- Ceiling  
 means of egress ..... 9.3.3.4.2 ..... 9-11

- Center of gravity ..... 6.2.2.10 ..... 6-7  
     6.2.5.4.1 .....  
     - 6.2.5.4.2 ..... 6-11  
     6.2.6.1 ..... 6-11  
     6.3.3.1.3 ..... 6-16  
     6.3.5.1.3 ..... 6-20  
 labels ..... 12.16.14 ..... 12-31  
     ..... 12.16.15 ..... 12-32  
 Center reading meters ..... 6.14.2.8 ..... 6-90  
 Certification  
   of automated information systems  
     11.1.4 ..... 11-2  
   of security safeguards  
     11.1.2 ..... 11-2  
 Changes ..... 6.7.3.5.7 ..... 6-45  
 Changing password ..... 11.3.2.1 ..... 11-8  
 Character(s)  
   alphanumeric character displays  
     7.2.4.6 ..... 7-26 - 7-27  
   capitalization ..... 8.2.3.1, 8.2.3.2 ..... 8-48  
   dot matrix ..... 8.2.3.10 ..... 8-49  
   height  
     in control labels ... 7.5.3.1 ..... 7-99  
     in CRT displays ... 7.2.4.6.2 ..... 7-26  
     in labels ..... 6.3.5.3.1 ..... 6-21  
     6.3.5.3.7 ..... 6-21  
     in text ..... 8.2.3.7 ..... 8-49  
   size, electroluminescent displays  
     7.2.8.4 ..... 7-35  
   size, large-screen projection  
     7.2.5.2.6 ..... 7-31  
   spacing ..... 6.3.5.3.5 ..... 6-21  
     7.2.4.7.7 ..... 7-28  
     7.5.3.6 ..... 7-100  
     8.2.3.3 ..... 8-48  
 stroke width ..... 8.2.3.9 ..... 8-49  
   in control labels ... 7.5.3.2 ..... 7-99  
     7.5.3.3, 7.5.3.4 ..... 7-99  
   style, large-screen projection  
     7.2.5.2.5 ..... 7-30  
   viewing distance ..... 8.2.3.7 ..... 8-49  
   width ..... 8.2.3.8 ..... 8-49  
   width-height ratio ..... 6.3.5.3.4 ..... 6-21  
     7.2.4.7.5 ..... 7-27  
     7.5.3.5 ..... 7-99  
 Character string search capability  
   8.4.2.2.4 ..... 8-90  
   8.3.10.4.18 ..... 8-79  
   4.3.3 ..... 4-5  
 Circles, distinguishing mark for menu options  
   8.3.7.3.5.d ..... 8-67  
 Circuit(s)  
   identification of ..... 6.13.5.3 ..... 6-89  
   identification of open ..... 6.13.1.3 ..... 6-84  
   location ..... 6.10.2.2.2.a ..... 6-73  
   packaging ..... 6.10.2.2.2.a ..... 6-73  
 Circuit breaker(s) ..... 6.13 ..... 6-83 - 6-89  
   for individual units ... 6.13.1.4 ..... 6-84  
   grouping ..... 6.13.1.2 ..... 6-84  
   identification of ..... 6.12.3.5 ..... 6-83  
   labeling ..... 6.13.5.1 ..... 6-88  
   legend switch ..... 6.13.4.2 ..... 6-88  
   push-pull ..... 6.13.3 ..... 6-85  
   selection ..... 6.13.1.1 ..... 6-83  
   toggle switch ..... 6.13.4.1 ..... 6-86  
 Circuit diagrams (in user documentation)  
   10.4.4.5.3 ..... 10-37  
 Circuit packaging  
   grouping ..... 6.10.2.2.2.d ..... 6-73  
   modules ..... 6.10.2.2.3.b ..... 6-73  
   parts ..... 6.10.2.2.3.a ..... 6-73  
   single board ..... 6.10.2.2.2.c ..... 6-73  
 Circuit symbols (in user documentation)  
   10.2.4.13.1 ..... 10-18  
 Clamps ..... 6.9.1.5 ..... 6-62  
   6.9.2.3 ..... 6-68  
   heat resistant ..... 6.9.2.2.5 ..... 6-68  
   location of ..... 6.9.1.5.4 ..... 6-62  
   mounting ..... 6.9.1.5.7 ..... 6-63  
   nonconductive ..... 6.9.1.5.8 ..... 6-63  
   operation of ..... 6.9.1.5.2 ..... 6-62  
   snug fit ..... 6.9.1.5.1 ..... 6-62  
   spring ..... 6.9.2.3.2 ..... 6-68  
   visibility of ..... 6.9.1.5.6 ..... 6-62  
 Classification levels ..... 11.3.1.9 ..... 11-5  
 Classified data (*see* Data, classified)  
 Cleaning solvents, use ..... 12.9.5 ..... 12-19  
 Clearance  
   around service points 6.14.4.1 ..... 6-91  
   between equipment ... 6.3.4.1.4 ..... 6-18  
   dimensions ..... 9.1.2 ..... 9-1  
   finger ..... 12.2.2.6 ..... 12-4  
   for handles ..... 6.2.5.4.4 ..... 6-11  
   95th percentile ..... 9.4.1 ..... 9-28  
     14.1.2.4 ..... 14-6  
   99th percentile ..... 9.3.4.5.5 ..... 9-15  
     14.1.2.5 ..... 14-7  
 Click (a pointing device button)  
   8.8.3.7.1.c ..... 8-146  
 "Close"  
   availability of ..... 8.2.2.3.2 ..... 8-47  
   log off ..... 8.2.2.3.2 ..... 8-47  
   operation ..... 8.3.5.14 ..... 8-63  
   secondary windows ... 8.3.2.1.3.c ..... 8-56  
 Closed window (*see* Window states, closed)  
 Closing a window  
   primary ..... 8.3.4.1.3 ..... 8-59  
   secondary ..... 8.3.4.1.4 ..... 8-59  
 Closure in user-computer interaction  
   8.1.1.19 ..... 8-3  
 Clothing  
   added clearance for ... 9.3.1.2 ..... 9-8  
     9.3.2.1 ..... 9-10  
     9.4.1 ..... 9-31  
   arctic ..... 13.3.7 ..... 13-6  
   design compatibility . 4.2.1.e ..... 4-3  
   designing ..... 14.1.2.9 ..... 14-7  
   effects of ..... 14.1.4.7 ..... 14-10  
     14.3.1.2 ..... 14-16  
   effects on reach ..... 14.4.4 ..... 14-40  
   emergency exit with bulky clothing  
     9.3.4.4.1 ..... 9-15  
 Coding (*see also* Alphanumeric coding, Auditory coding, Brightness coding, Color coding, Flash coding, Line coding, Symbol coding, Shape coding, Size coding, Tonal coding, and Visual coding)  
   areas in maps ..... 8.5.8.1.9 ..... 8-119  
   cables ..... 6.9.1.8.5 ..... 6-65  
   connectors .  
     noninterchangeable  
       6.8.8.2 ..... 6-55  
     with alignment device  
       6.8.8.11 ..... 6-56

- Coding (continued)
- consistency ..... 6.7.4.4 ..... 6-47
  - for orientation ..... 6.9.1.8.6 ..... 6-65
  - in command languages
    - 8.1.13.11 ..... 8-30
  - in data displays ..... 8.5.4 ..... 8-104 - 8-107
    - consistency ..... 8.5.4.1.4 ..... 8-104
    - data categories ..... 8.5.4.1.3 ..... 8-104
    - lines and curves ... 8.5.5.6.3 ..... 8-113
    - special codes ..... 8.5.4.1.5 ..... 8-104
    - when to use ..... 8.5.4.1.2 ..... 8-104
  - information skills ..... 10.1.1.2 ..... 10-2
  - left-hand bolts ..... 6.7.3.1.6 ..... 6-41
  - left-hand nuts ..... 6.7.3.1.6 ..... 6-41
  - lines ..... 6.9.2.4.4 ..... 6-70
  - meaningful ..... 8.5.4.1.1 ..... 8-104
  - menu options ..... 8.1.11.9 ..... 8-26
  - number ..... 6.9.1.9.1 ..... 6-64
  - pins ..... 6.8.5.1.12 ..... 6-52
  - plugs ..... 6.8.5.1.12 ..... 6-52
    - 6.8.8.1 ..... 6-55
    - 6.8.7.4 ..... 6-55
  - seals ..... 6.8.7.4 ..... 6-55
  - Cognitive disabilities ..... 10.6.4 ..... 10-67
  - Cognitive task elements .. 5.5.5 ..... 5-17
    - cognitive models ..... 5.6.2 ..... 5-18
    - human interfaces ..... 5.6.4 ..... 5-19
  - Cognitive understanding . 10 ..... 10-1
  - Collating test equipment
    - advantages ..... 6.15.5 ..... 6-99
    - disadvantages ..... 6.15.5 ..... 6-99
    - out-of-tolerance signals
      - 6.15.5.1 ..... 6-99
  - Color(s) (*see also* Color coding)
    - and reproduction (of a document)
      - 10.3.3.9.3 ..... 10-31
    - as a typographic cue . 10.3.3.9.1 ..... 10-31
    - conventions, consistent with
      - 8.2.4.1.9 ..... 8-51
    - CRT displays ..... 7.2.4.2 ..... 7-23 - 7-24
    - dot matrix emitters ... 7.2.6.5 ..... 7-32
    - equipment ..... 12.3.7 ..... 12-5
    - field label ..... 8.4.3.2.6 ..... 8-93
    - field label terminator 8.4.3.3.5 ..... 8-94
    - for codes
      - numbers of ..... 6.3.5.5.1 ..... 6-22
      - recommended ..... 6.3.5.5.2 ..... 6-22
    - for text ..... 6.3.5.3.9 ..... 6-22
    - in displays
      - additional ..... 8.2.4.1.12 ..... 8-51
      - adjacent colors ... 8.2.4.1.13 ..... 8-51
      - ambient illumination
        - 8.2.4.1.14 ..... 8-52
      - as information discriminator
        - 8.2.4.1.1.a ..... 8-50
      - comparisons ..... 8.2.4.1.23 ..... 8-53
      - consistency ..... 8.2.4.1.1.b ..... 8-50
      - constraints ..... 8.2.4.1.7 ..... 8-51
      - contrast with background
        - 8.2.4.1.20 ..... 8-52
      - contrasting features
        - 8.2.1.4.7 ..... 8-43
      - conventions ..... 8.2.4.1.9 ..... 8-51
      - discriminability of
        - 8.2.4.1.4 ..... 8-51
      - for actions ..... 8.2.4.1.6 ..... 8-51
    - for infrequently used information
      - 8.2.4.1.5 ..... 8-51
    - for status ..... 8.2.4.1.6 ..... 8-51
    - graphic data ..... 8.4.6.2.7 ..... 8-100
    - highlighting ..... 8.2.4.1.25 ..... 8-53
    - key ..... 8.2.4.1.15 ..... 8-52
    - number of ..... 8.2.4.1.10 ..... 8-51
    - of background ..... 6.3.5.3.9 ..... 6-22
    - one meaning per color
      - 8.2.4.1.8 ..... 8-51
    - periphery of display
      - 8.2.4.1.16 ..... 8-52
    - portable applications
      - 8.2.4.1.19 ..... 8-52
    - redundant ..... 8.2.4.1.1.d ..... 8-50
    - return to default settings
      - 8.2.4.1.18 ..... 8-52
    - selection principles
      - 8.2.4.1.1 ..... 8-50
      - small areas ..... 8.2.4.1.24 ..... 8-53
      - standardized ..... 8.2.4.1.1.e ..... 8-50
      - user expectations . 8.2.4.1.1.c ..... 8-50
      - user settings ..... 8.2.4.1.17 ..... 8-52
      - when to use ..... 8.2.4.1.2 ..... 8-50
    - in map displays ..... 8.5.8.5.5 ..... 8-123
    - in text ..... 6.3.5.3.9 ..... 6-22
      - 10.3.3.9.2 ..... 10-31
    - pointer (scale indicator)
      - 7.2.3.1.11 ..... 7-20
  - Color coding (*see also* Tonal coding)
    - 10.6.3.c ..... 10-66
    - bolts ..... 6.7.4.1 ..... 6-47
    - cables ..... 6.9.1.8.1 ..... 6-64
    - capacitors ..... 6.9.1.8.7 ..... 6-65
    - conductors ..... 6.9.1.8.4 ..... 6-65
    - connectors, electrical 6.9.1.8.1 ..... 6-64
    - controls ..... 7.4.1.4 ..... 7-59
    - CRT displays ..... 7.2.4.2.3 ..... 7-23
    - fluid lines ..... 6.9.2.4.1 ..... 6-68
    - hydraulic lines ..... 6.9.2.4.3 ..... 6-70
    - indicator lights ..... 7.2.2.3.3 ..... 7-17
    - in displays ..... 8.5.4.5 ..... 8-105 - 8-106
      - attention drawing . 8.5.4.5.5 ..... 8-106
      - data categories .... 8.5.4.5.2 ..... 8-106
      - discriminable, conservative, consistent use
        - 8.5.4.5.4 ..... 8-106
      - redundance ..... 8.5.4.5.3 ..... 8-106
      - reserved meanings of colors
        - 8.5.4.5.1 ..... 8-106
      - rules for coding enclosed areas
        - 8.5.5.4.3 ..... 8-110
    - in map windows ..... 8.3.12.4.6 ..... 8-83
    - insulated wire ..... 6.9.1.8.1 ..... 6-64
    - in transilluminated displays
      - 7.2.2.1.20 ..... 7-15
    - key, in map windows
      - 8.3.12.4.5 ..... 8-83
    - key-operated switches
      - 7.4.4.2.2 ..... 7-67
    - LEDs ..... 7.2.7.4 ..... 7-33
    - legend lights ..... 7.2.2.2.2 ..... 7-15
    - pneumatic lines ..... 6.9.2.4.3 ..... 6-70
    - resistors ..... 6.9.1.8.7 ..... 6-65
    - rocker switches ..... 7.4.4.12.1 ..... 7-82
    - scale indicators ..... 7.2.3.1.14
      - 7.2.3.1.16 ..... 7-20



- Color coding (continued)
- symbols ..... 8.2.4.3 ..... 8-54
    - brightness ..... 8.2.4.3.3 ..... 8-54
    - refresh rate ..... 8.2.4.3.4 ..... 8-54
    - size of symbol ..... 8.2.4.3.2 ..... 8-54
    - when to use ..... 8.2.4.3.1 ..... 8-54
  - telephone handsets .... 7.3.5.3.3 ..... 7-50
  - thumbwheel OFF position
    - 7.4.4.3.3 ..... 7-68
  - valves ..... 6.9.2.4.2 ..... 6-69
- Color (in windows) ..... 8.3.10.3 ..... 8-77
- applicable criteria and guidelines
    - 8.3.10.3.1 ..... 8-77
    - coding and status colors not changeable
      - 8.3.10.3.4 ..... 8-77
    - consistent use ..... 8.3.10.3.2 ..... 8-77
    - limited use ..... 8.3.10.3.3 ..... 8-77
    - user preferences ..... 8.3.10.3.5 ..... 8-77
- Columns (in a document)
- 10.3.2.7 ..... 10-24
    - number of ..... 10.3.2.7.1 ..... 10-24
    - white space ..... 10.3.2.7.2 ..... 10-24
    - width ..... 10.3.2.7.3 ..... 10-25
- "Combine" (query language search operation)
- 8.1.14.5.1.c ..... 8-34
- Combustible
- explosive ..... 12.11.3 ..... 12-20
  - liquids ..... 12.6.6 ..... 12-16
- Comfort zone ..... 13.3 ..... 13-3
- Command(s)
- editing commands .... 8.1.5.3.1 ..... 8-13
  - entry area, in application-level windows
    - 8.3.10.1.1.e ..... 8-73
  - examples of in on-line help
    - 8.6.1.5.9 ..... 8-129
  - expert query language users
    - 8.1.14.6.7 ..... 8-36
  - format, help on ..... 8.6.1.5.10 ..... 8-129
  - help on ..... 8.6.1.5.8 ..... 8-129
  - in a query language ... 8.1.14.4.1 ..... 8-33
  - novice query language users
    - 8.1.14.6.6 ..... 8-36
  - unrecognized commands
    - 8.1.5.3.3 ..... 8-13
  - wording of menu options
    - 8.1.11.8.2 ..... 8-25
- Command, Control, Communication
- architecture ..... 5.4.1 ..... 5-13
  - C3 systems ..... 5.4 ..... 5-13 - 5-16
  - changes role, functions
    - 5.4.2 ..... 5-14
  - communications (*see also*)
    - human groups ..... 5.4.1 ..... 5-13
    - models ..... 5.4.3 ..... 5-14
    - transition phases ..... 5.4.2 ..... 5-14
- Command language interaction method
- 8.1.13 ..... 8-29 - 8-30
  - abbreviation of commands
    - 8.1.13.10 ..... 8-30
  - alternate wording ..... 8.1.13.12 ..... 8-30
  - appropriate use ..... 8.1.8.1.e ..... 8-18
  - blank spaces ..... 8.1.13.16 ..... 8-30
  - characters ..... 8.1.13.14 ..... 8-30
  - coding ..... 8.1.13.11 ..... 8-30
  - complexity ..... 8.1.13.3 ..... 8-29
  - commands as functions
    - 8.1.13.1 ..... 8-29
  - consistent with menu selection
    - 8.1.11.1.4 ..... 8-20
  - confirmation ..... 8.1.13.20 ..... 8-30
  - consistent syntax ..... 8.1.13.2 ..... 8-29
  - ease of learning and use
    - 8.1.13.4 ..... 8-29
  - editing ..... 8.1.13.18 ..... 8-30
  - editing commands .... 8.1.5.3.1 ..... 8-13
  - entry area ..... 8.1.13.6 ..... 8-29
  - execution ..... 8.1.13.19 ..... 8-30
  - prompting for correction
    - 8.1.5.3.2 ..... 8-13
  - punctuation ..... 8.1.13.15 ..... 8-30
  - spelling errors ..... 8.1.13.17 ..... 8-30
  - stacking of commands
    - 8.1.13.5 ..... 8-29
  - unrecognized commands
    - 8.1.13.21 ..... 8-30
    - 8.1.5.3.2,
    - 8.1.5.3.3 ..... 8-13
  - word length ..... 8.1.13.13 ..... 8-30
  - wording ..... 8.1.13.9 ..... 8-29
  - 8.1.13.12 ..... 8-30
- Command stacking ..... 8.1.13.5 ..... 8-29
- errors in ..... 8.1.5.3.4 ..... 8-13
- execution ..... 8.1.5.3.6 ..... 8-13
- in transactions
- availability ..... 8.1.6.14 ..... 8-15
  - macros ..... 8.1.6.16 ..... 8-15
  - punctuation ..... 8.1.6.15 ..... 8-15
  - partial execution ..... 8.1.5.3.5 ..... 8-13
- Commercial off-the-shelf equipment
- 11.1.3 ..... 11-2
  - documentation for .... 11.6.2 ..... 11-11
  - evaluation and selection of
    - 1.3.2 ..... 1-2
    - 4 ..... 4-1
  - lexicon ..... 10.2.4.1.1 ..... 10-12
  - modification of ..... 1.3.2 ..... 1-2
  - prior to commitment . 1.3.2 ..... 1-2
  - safe use of ..... 1.3.2 ..... 1-2
- Communication links,
- design compatibility
    - 4.2.1.a ..... 4-3
- Communication(s)
- alternatives, prioritization
    - 5.4.7 ..... 5-16
  - automation ..... 5.4.6 ..... 5-16
  - backup (*see* backup)
  - modes of operation ... 5.4.4 ..... 5-15
  - monitoring ..... 5.4.1 ..... 5-13
  - preplanned alternatives
    - 5.4.7 ..... 5-16
  - rerouted ..... 5.4.8 ..... 5-16
  - status displays (*see* status displays)
  - subsystems ..... 5.4.4 ..... 5-15
    - control ..... 5.4.7 ..... 5-16
    - modes of operation
      - 5.4.4 ..... 5-15
    - voice communications
      - 5.6.1 ..... 5-18
- Comparing data
- character-by-character
    - 8.5.1.16 ..... 8-103
  - consistent formats in data displays
    - 8.5.5.4.7 ..... 8-111
  - map areas ..... 8.5.8.1.9 ..... 8-119

- Comparing data (continued)  
 reference values ..... 8.5.5.2.1 ..... 8-108  
 similarities, differences, trends  
 8.5.1.15 ..... 8-103
- "Compile" (query language operation)  
 8.1.14.5.3.b ..... 8-34
- Complementary documents  
 2 ..... 2-1
- Complex sounds as auditory signals  
 7.3.1.3 ..... 7-42
- Component(s)  
 disposal ..... 6.1.1.1 ..... 6-2  
 easy removal ..... 6.4.5.5 ..... 6-27  
 edges ..... 12.5.1.2 ..... 12-13  
 hazardous ..... 12.5.2.2 ..... 12-15  
 maintenance of ..... 6.1.2.7 ..... 6-3  
 not damaging ..... 6.4.5.8 ..... 6-27  
 projecting ..... 12.5.1.6 ..... 12-15  
 replacement of ..... 6.1.2.8 ..... 6-4  
 systems ..... 5 ..... 5-1  
 without removing ..... 6.4.2.2 ..... 6-24  
 6.4.5.7 ..... 6-27
- Component packaging  
 component placement 6.10.2.2.4.b ..... 6-73  
 grouping components 6.10.2.2.4.a,  
 6.10.2.2.4.c ..... 6-73  
 6.10.2.2.4.d ..... 6-73
- Comprehension ..... 10.2.1.3 ..... 10-5
- Computer aids (*see also* Computer models)  
 drawing figures ..... 8.5.5.3.11 ..... 8-109  
 graphic data ..... 8.5.5.3.1 ..... 8-109
- Computer based models (*see also* models)  
 analytic tools ..... 5.1 ..... 5-1  
 user acceptability ..... 5.1.2.3 ..... 5-3
- Computer model(s) (*see also* Computer aids)  
 for creating graphic data displays  
 8.5.5.3.16 ..... 8-110
- Computer room as "closed area"  
 11.5.2 ..... 11-10
- Conductor(s)  
 color coding of ..... 6.9.1.8.4 ..... 6-65  
 insulated ..... 6.9.1.3.3 ..... 6-60  
 segregated ..... 12.4.1.6 ..... 12-8
- Confirmation  
 abort action ..... 8.1.4.1 ..... 8-9  
 a command ..... 8.1.13.20 ..... 8-30  
 destructive actions ..... 8.1.5.1.10 ..... 8-11  
 8.1.1.27 ..... 8-4  
 invalid data ..... 8.4.7.3 ..... 8-101  
 large or slow data base retrievals  
 8.1.14.1.6 ..... 8-31  
 log off (application) .. 8.2.2.2.8 ..... 8-47  
 log off (system) ..... 8.2.2.2.8 ..... 8-47  
 8.3.9.1.5 ..... 8-70  
 message and entry .... 8.1.5.2.2 ..... 8-12  
 restart action ..... 8.1.4.8 ..... 8-10  
 valid data ..... 8.4.7.2 ..... 8-101
- Confirmation message windows  
 8.3.10.2.10 ..... 8-76
- Conflicts between this HFDG and other  
 documents ..... 2 ..... 2-1
- Connecting equipment .... 6.3.1.3 ..... 6-14
- Connector(s)(ing) (*see also* Quick fastening devices)  
 6.8 ..... 6-47 - 6-56  
 accessibility ..... 6.8.3 ..... 6-49  
 accessible ..... 6.15.1.3.1 ..... 6-95  
 alignment devices ..... 6.8.4 ..... 6-50  
 6.8.8.11 ..... 6-56  
 coding ..... 6.8.4.4 ..... 6-50  
 disassembly ..... 6.8.5.1.14 ..... 6-52  
 distinctive ..... 6.8.2.1.1, 6.8.2.1.2 ..... 6-48  
 12.6.2 ..... 12-16  
 equipment ..... 6.3.1.3 ..... 6-14  
 external ..... 6.3.3.3 ..... 6-17  
 high torque ..... 6.8.3.7 ..... 6-50  
 labeling ..... 6.8.8.1 ..... 6-55  
 location ..... 6.8.3 ..... 6-49  
 6.8.6.4, 6.8.6.5 ..... 6-54  
 6.10.3.1.11 ..... 6-75  
 noninterchangeable ... 6.8.8.1 ..... 6-55  
 nonshorting ..... 6.8.5.1.11 ..... 6-52  
 selection ..... 6.8.6.4 ..... 6-54  
 compatibility ..... 6.8.1.4 ..... 6-47  
 maintenance ..... 6.8.1.1 ..... 6-47  
 operation ..... 6.8.1.3 ..... 6-47  
 safety ..... 6.8.1.2 ..... 6-47  
 spacing ..... 6.8.3.6 ..... 6-49  
 type of (*see also* Distinctive connectors, Electrical  
 connectors, Fluid line connectors, Gas line  
 connectors, Plug-in connectors, Threaded  
 connectors, Quick fastening connectors)  
 quick-action ..... 6.2.9.2 ..... 6-13
- Consequences, of risk ..... 5.3.4 ..... 5-11
- Consistency  
 hear and feel ..... 8.9.6.2.3 ..... 8-155  
 human interfaces ..... 5.1.1 ..... 5-2  
 maintenance automation  
 5.1.1 ..... 5-2  
 procedures ..... 5.1.1 ..... 5-2
- Console(s)  
 design of ..... 9.5 ..... 9-43 - 9-52  
 multiperson  
 arrangement of ..... 9.5.4 ..... 9-47  
 design of ..... 9.5.4 ..... 9-47  
 selection of ..... 9.5.4.1 ..... 9-47  
 types ..... 9.5.4.2 ..... 9-49  
 selection of ..... 9.5.1.2 ..... 9-46  
 sit ..... 9.5.1 ..... 9-43  
 sit-stand ..... 9.5.1 ..... 9-43  
 9.5.4.2 ..... 9-49  
 height of ..... 9.5.4.5 ..... 9-51  
 stand ..... 9.5.1 ..... 9-43  
 9.5.4.2 ..... 9-49  
 control placement 9.5.4.4 ..... 9-51  
 display placement 9.5.4.4 ..... 9-51  
 types of ..... 9.5.1.1 ..... 9-44  
 wrap-around ..... 9.5.2 ..... 9-46
- Constrained natural language (*see* Natural language)
- Contact plates on equipment  
 9.3.3.1.3 ..... 9-11
- Contacts, exposed ..... 12.4.1.12 ..... 12-8
- Context in user-computer interaction  
 8.2.1.3 ..... 8-41 - 8-42  
 action history ..... 8.2.1.3.8 ..... 8-42  
 context-dependent actions  
 8.2.1.3.7 ..... 8-42  
 control parameters, display of  
 8.2.1.3.9 ..... 8-42  
 current context, display of  
 8.2.1.3.6 ..... 8-42  
 format ..... 8.2.1.3.3, 8.2.1.3.4 ..... 8-42  
 highlighting ..... 8.2.1.3.2 ..... 8-41  
 location ..... 8.2.1.3.3 ..... 8-42

- Context in user-computer interaction (continued)
- maintaining context .. 8.2.1.3.1 ..... 8-41
  - operational mode ..... 8.2.1.3.5 ..... 8-42
  - position ..... 8.2.1.3.4 ..... 8-42
- Context-sensitive help (*see* On-line help, context-sensitive)
- Contingency management
- 4.2.3.d ..... 4-3
- "Continue" as an option in transactions
- 8.1.6.12 ..... 8-15
  - resume interrupted sequence
    - 8.1.4.7 ..... 8-10
  - user interrupt ..... 8.1.4.1, 8.1.4.6 ..... 8-9
- Contract ..... 1.4.1.1 ..... 1-3
- Contractor use ..... 1.3.1 ..... 1-2
- Contrast
- foreground and background
    - color ..... 6.3.5.3.9 ..... 6-22
    - controls ..... 7.4.1.4.7 ..... 7-61
    - counters ..... 7.2.9.1.7 ..... 7-39
    - flags ..... 7.2.9.4.4 ..... 7-41
    - plotters ..... 7.2.9.3.3 ..... 7-40
    - printers ..... 7.2.9.2.2 ..... 7-39
  - print ..... 10.3.3.8.1 ..... 10-32
  - text and background . 6.3.5.3.9 ..... 6-22
- Control(s) (*see also* remote control)
- accidental actuation prevention
    - 7.4.1.6 ..... 7-62 - 7-63
  - ADA ..... 7.6.3.1 ..... 7-109
  - adjustable illumination for
    - 7.1.1.6 ..... 7-2
  - adjustable timing ..... 7.6.3.1 ..... 7-109
    - guarding internal controls
      - 7.4.1.6.2 ..... 7-62
    - guarding methods 7.4.1.6.4 ..... 7-62
    - location and design
      - 7.4.1.6.1 ..... 7-62
  - adjustment ..... 6.11 ..... 6-80 - 6-81
    - access ..... 6.11.2 ..... 6-80
    - arrangement ..... 6.11.6 ..... 6-80
    - differentiating types
      - 6.11.4 ..... 6-80
    - feedback ..... 6.11.1 ..... 6-80
    - guarding ..... 6.11.20 ..... 6-81
    - independence ..... 6.11.5 ..... 6-80
    - labeling ..... 6.11.20 ..... 6-81
    - limited range ..... 6.11.15 ..... 6-81
    - location of ..... 6.11.3 ..... 6-80
      - 6.11.17 ..... 6-81
    - mounting ..... 6.11.17 ..... 6-81
    - of test point ..... 6.14.1.1, 6.14.1.2 ..... 6-89
    - shielding ..... 6.11.20 ..... 6-81
    - vibration of ..... 6.11.18 ..... 6-81
    - with range ..... 6.11.15 ..... 6-81
    - with screwdrivers 6.11.10 ..... 6-81
  - automation ..... 5.2.16 ..... 5-8
  - ball controls (*see* Ball controls)
  - blind operation ..... 7.4.1.5.3 ..... 7-62
  - coding of ..... 7.4.1.4 ..... 7-59
    - advantages and disadvantages of different methods ..... 7.4.1.4.1 ..... 7-59
    - ambient illumination
      - 7.4.1.4.8 ..... 7-61
      - color ..... 7.4.1.4.5 - 7.4.1.4.8 ..... 7-61
      - contrast ..... 7.4.1.4.7 ..... 7-61
      - control-display association
        - 7.4.1.4.6 ..... 7-61
      - location ..... 7.4.1.4.2 ..... 7-60
      - shape ..... 7.4.1.4.4 ..... 7-60
      - size ..... 7.4.1.4.3 ..... 7-60
    - combined for power and volume
      - 7.3.5.4.3 ..... 7-61
    - compatibility with handwear
      - 7.4.1.5.1 ..... 7-61
      - 7.4.1.5.2 ..... 7-59
    - cranks (*see* Cranks)
    - "dead man" ..... 7.4.1.6.5 ..... 7-62
    - design of ..... 6.15.1.4.4 ..... 6-96
    - direction of movement
      - consistency ..... 7.4.1.2.1 ..... 7-58
      - valve controls ..... 7.4.1.2.2 ..... 7-58
    - display when unavailable
      - 8.3.10.1.11 ..... 8-74
    - duplicate ..... 7.3.5.4.6 ..... 7-51
    - emergency ..... 7.3.5.4.6 ..... 7-51
    - evaluation using prototypes
      - 7.4.1.5.2 ..... 7-62
    - fine control, alternatives
      - 7.6.3.1 ..... 7-109
    - foot-operated (*see* Foot-operated controls)
    - foot-operated switches (*see* Foot-operated switches)
    - for adjustment only .. 7.4.1.3.6 ..... 7-58
    - for audio warning devices
      - 7.3.4 ..... 7-47
    - for hazardous operations
      - 12.3.1 ..... 12-4
    - for maintenance only 7.4.1.3.6 ..... 7-58
    - for people with disabilities
      - 8.9.2.7 ..... 8-152
    - force ..... 7.6.3.1 ..... 7-109
    - grid and stylus devices (*see* Grid and stylus devices)
    - grouped in a control window
      - 8.3.10.1.11 ..... 8-74
    - grouping and arrangement
      - 7.4.1.2.1 ..... 7-58
      - consistency ..... 7.4.1.3.4 ..... 7-58
      - primary controls .. 7.4.1.3.3 ..... 7-58
      - sequential operation
        - 7.4.1.3.2 ..... 7-58
      - spacing ..... 7.4.1.3.7 ..... 7-59
    - hand controls requiring high force (*see* Hand controls requiring high force)
    - handedness provisions
      - 7.6.3.1 ..... 7-109
    - in data entry windows
      - 8.3.12.2.1 ..... 8-81
      - 8.3.12.2.5 ..... 8-81
    - in map windows ..... 8.3.12.4.1 ..... 8-83
    - joysticks (*see* Joysticks)
    - keyboards (*see* Keyboards)
    - key-operated switches (*see* Key-operated switches)
    - knobs (*see* Knobs)
    - labeling and marking
      - abbreviations ..... 7.5.5.2 ..... 7-101
      - ambient illumination
        - 7.5.4.1 ..... 7-100
        - 7.5.4.2 ..... 7-100
      - avoiding obscuring
        - 7.5.2.10 ..... 7-99
      - boldface type ..... 7.5.1.5.c ..... 7-97
      - borders ..... 7.5.4.5 ..... 7-101
      - case of letters ..... 7.5.3.9 ..... 7-100
      - character height ... 7.5.3.1 ..... 7-99

- Control(s) (continued)
- character size ..... 7.5.1.2 ..... 7-96
  - 7.5.1.3 ..... 7-97
  - character spacing .. 7.5.3.6 ..... 7-100
  - character stroke width
    - 7.5.3.2 ..... 7-99
    - 7.5.3.3, 7.5.3.4 ..... 7-99
  - character transilluminated
    - 7.5.3.4 ..... 7-99
  - character type style
    - 7.5.4.3 ..... 7-100
  - character width-height ratios
    - 7.5.3.5 ..... 7-99
  - characters black on white
    - 7.5.3.2 ..... 7-99
    - 7.5.4.1 ..... 7-100
  - characters white on black
    - 7.5.3.3 ..... 7-99
    - 7.5.4.2 ..... 7-100
  - consistent location 7.5.2.7 ..... 7-98
  - control-display association
    - 7.5.1.9 ..... 7-97
    - 7.5.2.3 ..... 7-98
  - curved labels ..... 7.5.1.12 ..... 7-97
  - dark adaptation ... 7.5.4.2 ..... 7-100
  - distinctive ..... 7.5.1.6 ..... 7-97
  - distinctive characters
    - 7.5.4.4 ..... 7-100
  - durability ..... 7.5.1.5.d ..... 7-97
  - functional grouping
    - 7.5.2.6 ..... 7-98
  - hierarchical labeling
    - 7.5.2.8 ..... 7-98
  - horizontal orientation
    - 7.5.2.9 ..... 7-100
  - label contents ..... 7.5.1.4, 7.5.1.5 ..... 7-97
  - line spacing ..... 7.5.3.8 ..... 7-100
  - meaningful ..... 7.5.1.7 ..... 7-97
  - 7.5.1.8 ..... 7-97
  - mounting ..... 7.5.1.10 ..... 7-97
  - nonobstructing ..... 7.5.2.2 ..... 7-98
  - pictorial symbols .. 7.5.5.6 ..... 7-101
  - readability ..... 7.5.2.1 ..... 7-98
  - 7.5.2.10 ..... 7-99
  - reflectance ..... 7.5.1.13 ..... 7-98
  - relationship to control or display
    - 7.5.2.3, 7.5.2.4 ..... 7-98
  - relevant information
    - 7.5.5.5 ..... 7-101
  - removal ..... 7.5.1.11 ..... 7-97
  - separation ..... 7.5.2.5 ..... 7-98
  - tag mounting ..... 7.5.1.15 ..... 7-98
  - terms and designations consistent with user documentation and parts catalogs
    - 7.5.5.3 ..... 7-101
  - trade names excluded
    - 7.5.5.4 ..... 7-101
  - units of measurement
    - 7.5.1.4 ..... 7-97
  - viewing distance .. 7.5.3.1 ..... 7-99
  - when to use ..... 7.5.1.1 ..... 7-96
  - wording ..... 7.5.5.1 - 7.5.5.3 ..... 7-101
  - word spacing ..... 7.5.3.7 ..... 7-100
  - legend switches (*see* Legend switches)
  - levers (*see* Levers)
  - linear, when to use .... 7.1.3.9 ..... 7-5
  - maintenance of ..... 6.1.2.8 ..... 6-4
  - matching to users ..... 8.2.1.8 ..... 8-44
  - miniature (*see* Miniature controls)
  - on-site maintenance .. 5.8 ..... 5-24
  - placement on stand consoles
    - 9.5.4.4 ..... 9-51
  - press-to-talk button ... 7.3.5.5.5 ..... 7-52
  - printed circuit switches (*see* Printed circuit switches)
  - push buttons (*see* Push buttons (physical))
  - push-pull (*see* Push-pull)
  - remote ..... 7.4.1.3.5 ..... 7-58
  - remote maintenance .. 5.8 ..... 5-24
  - rocker switches (*see* Rocker switches)
  - rotary
    - when to use ..... 7.1.3.9 ..... 7-5
  - rotary selector switches (*see* Rotary selector switches)
  - selection of ..... 7.4.1.1 ..... 7-53
    - advantages and disadvantages of common characteristics of common controls
      - 7.4.1.1.5 ..... 7-54
    - controls ..... 7.4.1.1.6 ..... 7-55
    - continuous adjustment
      - 7.4.1.1.5 ..... 7-54
    - detents ..... 7.4.1.1.3 ..... 7-53
    - discrete adjustment
      - 7.4.1.1.5 ..... 7-54
    - distribution of workload
      - 7.4.1.1.1 ..... 7-55
      - limits ..... 7.4.1.1.4 ..... 7-54
      - multitrotation ..... 7.4.1.1.2 ..... 7-53
    - separate for power and volume
      - 7.3.5.4.2 ..... 7-51
    - simultaneous vs continuous
      - 7.6.3.1 ..... 7-109
  - slide switches (*see* Slide switches)
  - spacing ..... 7.6.3.1 ..... 7-109
  - squelch ..... 7.3.5.4.4 ..... 7-51
  - thumbwheels (*see* Thumbwheels)
  - twisting movement, avoid
    - 7.6.3.1 ..... 7-109
  - toggle switches (*see* Toggle switches)
  - transilluminated, visibility of
    - 13.4.3.1 ..... 13-10
  - voice redundancy ..... 7.6.3.1 ..... 7-109
  - volume, telephones ... 7.3.5.5.8 ..... 7-52
  - window ..... 8.3.3 ..... 8-57 - 8-59
    - consistency ..... 8.3.3.1.1 ..... 8-57
    - distinctive ..... 8.3.3.1.1 ..... 8-57
    - 8.3.3.1.2 ..... 8-58
    - exclusive button sets (*see also* Button sets, exclusive) ..... 8.1.15.3 ..... 8-38 - 8-39
    - nonexclusive button sets (*see also* Button sets)
      - 8.1.15.4 ..... 8-39
    - push buttons (*see also* Push buttons)
      - 8.1.15.2 ..... 8-37 - 8-38
    - scroll bars (*see also* Scroll bars)
      - 8.3.3.3 ..... 8-58
    - sliders (*see also* Sliders)
      - 8.1.15.5 ..... 8-39
    - text fields (*see also* Text fields)
      - 8.3.3.2 ..... 8-57
  - with scale and pointer
    - 6.11.16 ..... 6-81
- Control-display integration (*see* Display-control integration)

- Control entry area, cursor placement in  
8.1.6.11 ..... 8-14
- Control, maintenance (*see* Maintenance control)
- Control windows (*see* Windows, control)
- Conversion tables for tolerances  
6.15.1.1.3 ..... 6-94
- "Copy"  
data or objects  
by dragging ..... 8.4.4.1 ..... 8-97  
by temporary storage  
8.4.4.2 ..... 8-98  
editing operation ..... 8.4.2.2.3 ..... 8-90  
graphic data displays 8.5.5.3.13 ..... 8-109
- Copyright issues (in user documentation)  
10.4.15 ..... 10-48  
inclusion of copyrighted information  
10.4.15.2 ..... 10-48  
location of copyright information  
10.4.15.1 ..... 10-48  
prior consent to use copyrighted information  
10.4.15.2 ..... 10-48
- Cords, telephone ..... 7.3.5.5.2 ..... 7-52
- Corner(s)  
exposed ..... 12.5.1.5 ..... 12-14  
of cases ..... 6.6.1.7 ..... 6-35  
of covers ..... 6.5.1.8 ..... 6-29  
rounding ..... 12.5.1.5 ..... 12-14
- Correlation coefficient .... 14.1.5.3 ..... 14-14
- Corridor widths ..... 9.3.1.1 ..... 9-8
- COTS (*see* Commercial-off-the-shelf)
- Cotter keys ..... 6.7.3.5.2 ..... 6-44
- Cotter pins ..... 6.7.3.5.2 ..... 6-44
- Counters  
as visual displays ..... 7.2.9.1 ..... 7-38  
characteristics and ratings  
7.2.9 ..... 7-38  
contrast ..... 7.2.9.1.7 ..... 7-39  
glare ..... 7.2.9.1.6 ..... 7-39  
interval between numerals  
7.2.9.1.4 ..... 7-39  
mounting ..... 7.2.9.1.2 ..... 7-39  
movement ..... 7.2.9.1.3 ..... 7-39  
operating force .... 7.2.9.1.3.d ..... 7-39  
spacing between numerals  
7.2.9.1.5 ..... 7-39  
when to use ..... 7.2.9.1.1 ..... 7-38  
counts per revolution 7.1.4.8 ..... 7-6
- Cover(s) ..... 6.5 ..... 6-28 - 6-34  
access opening ..... 6.5.7.2 ..... 6-31  
and lids (ADA) ..... 7.6.1.3 ..... 7-104  
attached to equipment  
6.5.1.9 ..... 6-29  
attachment to equipment  
6.7.3.7.5 ..... 6-46  
different forms of .... 6.5 ..... 6-28  
edges and corners of  
6.5.1.8 ..... 6-29  
fastened-unfastened indicator  
6.5.1.3 ..... 6-28  
for legend switches ... 7.4.4.11.6 ..... 7-82  
for push buttons ..... 7.4.4.8.6 ..... 7-78  
for rocker switches ... 7.4.4.12.4 ..... 7-82  
for slide switches ..... 7.4.4.13.2 ..... 7-85  
for toggle switches ... 7.4.4.10.4 ..... 7-79  
grounding ..... 12.4.1.8 ..... 12-8  
hinged ..... 6.5.4.2, 6.5.5 ..... 6-30  
labeling ..... 6.5.10.1 ..... 6-34  
location ..... 6.5.4 ..... 6-30  
nonconductive ..... 12.4.1.8 ..... 12-8  
open  
how to ..... 6.5.1.1 ..... 6-28  
room to ..... 6.3.4.1.4 ..... 6-18  
on protrusions ..... 12.5.1.1 ..... 12-13  
removing ..... 6.4.1 ..... 6-23  
6.5.1.2 ..... 6-28  
shape of ..... 6.5.3 ..... 6-30  
size of ..... 6.5.2.1 ..... 6-29  
sliding ..... 6.5.4.2 ..... 6-30  
stops on ..... 6.5.1.6 ..... 6-29  
to high voltage ..... 12.4.1.9, 12.4.1.10 ..... 12-8  
ventilation holes in ... 6.5.1.7 ..... 6-29  
weight of ..... 6.5.2.1 ..... 6-29
- Covering, preferred type  
6.5.7 ..... 6-31
- Cover page (of a user document)  
10.4.1 ..... 10-33 - 10-34  
contents ..... 10.4.1.1 ..... 10-33  
type family ..... 10.4.1.3 ..... 10-34  
type size ..... 10.4.1.2 ..... 10-33  
10.4.1.4 ..... 10-34  
type style ..... 10.4.1.2 ..... 10-33
- Cranks ..... 7.4.4.7 ..... 7-75  
balance ..... 7.4.4.7.5 ..... 7-75  
combined with knob or handwheel  
7.4.4.7.2 ..... 7-75  
folding handles ..... 7.4.4.7.4 ..... 7-75  
grip handles ..... 7.4.4.7.3 ..... 7-75  
location of ..... 12.5.1.8 ..... 12-15  
specifications ..... 7.4.4.7.1 ..... 7-75  
when to use ..... 7.4.4.7.3 ..... 7-75
- Crawl space(s) ..... 9.3.2 ..... 9-9  
approval for ..... 9.3.2.1 ..... 9-10
- "Create" (query language search operation)  
8.1.14.5.1.b ..... 8-33
- Crimp-on devices  
clamping ..... 6.8.5.2.5 ..... 6-53  
wires terminating in .. 6.8.5.2.4 ..... 6-53
- Criteria  
potential design criteria  
1.4.1.1 ..... 1-3
- Critical data, display of  
8.5.5.2 ..... 8-108
- Critical information  
audible coding ..... 8.2.1.11.3 ..... 8-46  
coding of ..... 8.5.4.2.1 ..... 8-104  
display density ..... 8.5.1.5 ..... 8-102  
display in windows ... 8.2.1.10.2 ..... 8-45  
in large-screen displays  
7.2.5.1.5 ..... 7-29  
initial window placement  
8.3.11.3 ..... 8-79  
on-line help ..... 8.6.1.1.7 ..... 8-126
- Critical task sequences, information density  
8.5.1.5 ..... 8-102
- Crosshair cursor in map displays  
8.5.8.5.2 ..... 8-123
- Cross references (in user documentation)  
10.2.1.4 ..... 10-6
- CRT (*see also* Cathode Ray Tube)  
7.2.4 ..... 7-23 - 7-28  
alphanumeric characters  
dark characters, light background  
7.2.4.3.5 ..... 7-25  
7.2.4.6.4 ..... 7-27

- CRT (continued)
- font legibility ..... 7.2.4.6.1 ..... 7-26
  - height-width ratio 7.2.4.6.5 ..... 7-27
  - luminance contrast
    - 7.2.4.6.3 ..... 7-27
  - resolution elements
    - 7.2.4.6.5 ..... 7-27
  - spacing between characters
    - 7.2.4.7.7 ..... 7-28
  - spacing between lines
    - 7.2.4.7.9 ..... 7-28
  - spacing between words
    - 7.2.4.7.8 ..... 7-28
  - stroke width ..... 7.2.4.7.6 ..... 7-28
  - chromatic aberration . 7.2.4.1.4 ..... 7-23
  - color ..... 7.2.4.2 ..... 7-23
    - coding ..... 7.2.4.2.3 ..... 7-23
    - preferred ..... 7.2.4.2.1 ..... 7-23
    - saturation ..... 7.2.4.2.2 ..... 7-23
    - use limitations ..... 7.2.4.2.4 ..... 7-24
  - criteria and guidelines for use in office
    - environments ..... 7.2.4.5.4 ..... 7-26
    - display updating ..... 7.2.4.7.4 ..... 7-27
    - geometric distortion .. 7.2.4.1.3 ..... 7-23
    - pictorial or situation data
      - 7.2.4.7.1 ..... 7-27
      - minimum size ..... 7.2.4.7.2 ..... 7-27
    - refresh rate ..... 7.2.4.1.1 ..... 7-23
    - resolution elements
      - 7.2.4.7.3 ..... 7-27
    - screen phosphor and persistence
      - 7.2.4.1.2 ..... 7-23
    - viewing angle ..... 7.2.4.5.3 ..... 7-26
    - viewing distance ..... 7.2.4.5.1 ..... 7-25
    - 7.2.4.5.2 ..... 7-26
  - Cryogenic systems shielding
    - 12.10.1 ..... 12-19
  - Cues, visual, to users in windows
    - 8.1.1.2.3 ..... 8-4
  - Current, effects of ..... 12.4 ..... 12-5
  - Cursor(s)
    - control device ..... 8.9.2.4 ..... 8-152
    - control, keyboard ..... 7.4.4.9.4 ..... 7-78
    - flashing ..... 8.9.7.1 ..... 8-156
    - multiple ..... 8.4.2.1.5 ..... 8-89
  - Cursor, graphics ..... 8.4.6.1.2 ..... 8-99
    - activation component
      - 8.4.6.1.3 ..... 8-99
    - movement component
      - 8.4.6.1.3 ..... 8-99
    - operation of ..... 8.4.6.1.3 ..... 8-99
  - Cursor, location
    - in a pull-down menu . 8.3.2.4.5 ..... 8-57
    - in exclusive button sets
      - 8.1.15.3.2 ..... 8-38
    - initial location ..... 8.3.4.3.6 ..... 8-61
    - input focus ..... 8.3.4.3.5 ..... 8-60
    - 8.3.4.3.6 ..... 8-61
    - movement of ..... 8.3.4.3.6 ..... 8-61
    - moving from menu bar
      - 8.3.2.4.4 ..... 8-57
    - moving to menu bar .. 8.3.2.4.1 ..... 8-56
    - moving within menu bar
      - 8.3.2.4.2 ..... 8-57
    - shape of ..... 8.3.4.3.6 ..... 8-61
  - Cursor, map displays ..... 8.5.8.5.2 ..... 8-123
  - Cursor movement in forms
    - denied due to unacceptable entry
      - 8.4.3.8.2.a ..... 8-97
    - easy ..... 8.4.3.5.2 ..... 8-95
    - 8.4.2.1.6 ..... 8-89
    - enhanced ..... 8.4.2.1.7 ..... 8-89
    - for editing ..... 8.4.3.7.5 ..... 8-97
    - 8.4.2.1.6 ..... 8-89
    - "next" and "previous" fields
      - 8.4.3.5.6 ..... 8-95
    - not automatic ..... 8.4.3.5.3 ..... 8-95
    - not to protected fields
      - 8.4.3.5.5 ..... 8-95
    - only to fields and control objects
      - 8.4.3.5.4 ..... 8-95
  - Cursor movement keys, arrangement
    - 7.4.4.9.5 ..... 7-78
    - 8.8.1.5 ..... 8-139
    - 7.4.4.9.5 ..... 7-78
    - 8.8.1.5 ..... 8-139
  - Cursor position
    - for correcting a command
      - 8.1.5.3.2 ..... 8-13
    - for error correction ... 8.1.5.2.4,
      - 8.1.5.2.11 ..... 8-12
    - for keying ..... 8.1.6.11 ..... 8-14
    - for selection ..... 8.1.6.10 ..... 8-14
    - for selection by code entry
      - 8.1.11.7.3 ..... 8-25
    - for selection by pointing
      - 8.1.11.7.2 ..... 8-24
    - in forms, initial ..... 8.4.3.5.1 ..... 8-95
    - starting point ..... 8.2.1.7.2 ..... 8-44
  - Cursor, text ..... 8.4.2.4 ..... 8-91
    - appearance only in text entry areas
      - 8.3.8.4 ..... 8-68
    - box in replace mode .. 8.3.8.1 ..... 8-68
    - 8.4.2.4.1 ..... 8-91
    - description ..... 8.3.8.1 ..... 8-68
    - disappearance of pointer
      - 8.3.8.5 ..... 8-69
    - flash rate ..... 8.4.2.4.1 ..... 8-91
    - 8.3.8.1 ..... 8-68
    - I-beam in insert mode
      - 8.4.2.4.1 ..... 8-91
      - 8.3.8.1 ..... 8-68
    - input focus ..... 8.4.2.4.1 ..... 8-91
    - 8.3.8.1 ..... 8-68
    - location ..... 8.4.2.4.2 ..... 8-91
    - 8.3.8.2 ..... 8-68
    - movement by user .... 8.4.2.4.3 ..... 8-91
    - 8.3.8.3 ..... 8-69
  - Curves in graphic data displays
    - 8.5.5.6 ..... 8-113
    - area between ..... 8.5.5.7.1 ..... 8-113
    - coding ..... 8.5.5.6.3 ..... 8-113
    - highlighting ..... 8.5.5.6.2 ..... 8-113
    - labeling ..... 8.5.5.6.2 ..... 8-113
    - stacked ..... 8.5.5.7.2 ..... 8-113
    - use of ..... 8.5.5.6.1 ..... 8-113
  - Cushions on equipment ... 9.3.3.1.3 ..... 9-11
  - Customization by user
    - alarm parameters ..... 8.1.3.5.6 ..... 8-9
    - alignment grid intervals
      - 8.4.6.2.3 ..... 8-100

Customization by user (continued)

- appearance of map windows
  - 8.3.12.4.7 ..... 8-83
- coding and status colors not changeable
  - 8.3.10.3.4 ..... 8-77
- colors in displays ..... 8.2.4.1.17 ..... 8-52
- colors in windows ..... 8.3.10.3.5 ..... 8-77
- feedback on message transmission
  - 8.3.12.5.7 ..... 8-85
- grid lines, display of . 8.5.5.5.3 ..... 8-112
- icon location ..... 8.1.15.1.12 ..... 8-37
- information displays . 8.5.6.1.1 ..... 8-115
- interval for automatic log off
  - 8.3.9.1.6 ..... 8-70
- of user-computer interaction
  - 8.1.1.13 ..... 8-2
- presentation style of data display
  - 8.5.5.1.5 ..... 8-108
- return to normal display
  - 8.5.6.1.2 ..... 8-115
- rules in creating graphic data displays
  - 8.5.5.3.10 ..... 8-109
- system-level window parameters
  - 8.3.9.4.4 ..... 8-72
- text font size in windows
  - 8.3.10.4.4 ..... 8-77
- query language format
  - 8.1.14.1.12 ..... 8-32
  - 8.1.14.3.7 ..... 8-33

Cutoff, automatic ..... 12.11.3 ..... 12-20

Cyan in color combinations ..... 8.2.4.1.23 ..... 8-53

Cyclic data ..... 8.5.5.6.4 ..... 8-113

**D**

Dale-Chall formula ..... 10.2.3.2 ..... 10-8

Damage

- prevention of ..... 6.2.1.2 ..... 6-5
- 6.3.4 ..... 6-17
- to equipment ..... 6.2.1.1 ..... 6-5
- 6.2.7.1 ..... 6-12
- 6.2.8.1 ..... 6-12

Dark adaptation

- ambient light and ..... 13.4.3.3 ..... 13-11
- control labeling ..... 7.5.4.2 ..... 7-100
- controls used in ..... 13.4.3.1 ..... 13-10
- displays used in ..... 13.4.3.1 ..... 13-10
- for task performance . 13.4.3.2 ..... 13-10

Data

- bivariate ..... 14.1.5.2 ..... 14-13
- classified
  - processing ..... 11.5.2 ..... 11-10
  - protection ..... 11.5.2 ..... 11-10
  - transmitting ..... 11.5.2.2 ..... 11-10
- correlation
  - use of ..... 14.1.5 ..... 14-13 - 14-14
- distribution
  - use of ..... 14.1.5 ..... 14-13 - 14-14
- multiple correlation .. 14.1.5.3 ..... 14-14
- 14.1.6.4 ..... 14-15
- protection of ..... 11.5 ..... 11-9 - 11-11
- usage ..... 14.3.1 ..... 14-16

Data access ..... 8.5.6.3 ..... 8-116

- moving through continuous text
  - 8.5.6.3.2 ..... 8-116
- moving through data . 8.5.6.3.1 ..... 8-116

- moving through grouped information
  - 8.5.6.3.3 ..... 8-116

Data communications ..... 8.7 ..... 8-130 - 8-135

- addressing messages . 8.7.3 ..... 8-131
- directories and distribution lists
  - 8.7.3.3 ..... 8-132
- message formatting
  - 8.7.3.2 ..... 8-132
- user control ..... 8.7.3.1 ..... 8-132
- validation and error correction
  - 8.7.3.4 ..... 8-132

annotations to transmitted data
 

- 8.7.1.7 ..... 8-130

controlling transmission
 

- 8.7.5 ..... 8-133
- system control ..... 8.7.5.1 ..... 8-133
- transmission failure
  - 8.7.5.3 ..... 8-134
  - user control ..... 8.7.5.2 ..... 8-133

explicit receive action 8.7.1.4 ..... 8-130

explicit send action .. 8.7.1.4 ..... 8-130

incompatible data format
 

- 8.7.6.4 ..... 8-135

initiating transmission
 

- 8.7.4 ..... 8-132
- system control ..... 8.7.4.1 ..... 8-132
- user control ..... 8.7.4.2 ..... 8-132

integration with other system functions
 

- 8.7.1.1 ..... 8-130

notification of incoming messages
 

- 8.7.6.5 ..... 8-135

preparing messages .. 8.7.2 ..... 8-131

- message format ... 8.7.2.3 ..... 8-131
- user control ..... 8.7.2.2 ..... 8-131

receiving messages .. 8.7.6 ..... 8-134

- system control ..... 8.7.6.1 ..... 8-134
- user control ..... 8.7.6.2 ..... 8-134

user review of messages
 

- 8.7.6.3 ..... 8-134

replying to a message
 

- 8.7.6.6 ..... 8-135

user control and procedures
 

- 8.7.1 ..... 8-130

Data display (*see also* Graphic data display)

- 8.5 ..... 8-101 - 8-124
- arrangement ..... 8.5.1.17 ..... 8-103
- blank space ..... 8.5.1.12 ..... 8-102
- coding ..... 8.5.4 ..... 8-104
- comparing data
  - character-by-character
    - 8.5.1.16 ..... 8-103
  - similarities, differences, trends
    - 8.5.1.15 ..... 8-103
- consistency ..... 8.5.1.2, 8.5.1.3 ..... 8-102
- 8.5.1.11 ..... 8-102
- context ..... 8.5.1.18 ..... 8-103
- date and time information
  - 8.5.1.9 ..... 8-102
- density of display ..... 8.5.1.5 ..... 8-102
- display control ..... 8.5.6 ..... 8-115
- display regeneration and updating
  - 8.5.7 ..... 8-117
- essential data ..... 8.5.1.6 ..... 8-102
- formats ..... 8.5.1.11 ..... 8-102
- freezing ..... 8.5.7.3 ..... 8-118
- changing data ..... 8.5.7.3.1 ..... 8-118

- Data display (continued)
- labeling frozen display
    - 8.5.7.3.2 ..... 8-118
    - map displays ..... 8.5.8.2.15 ..... 8-120
    - 8.5.8.3.17 ..... 8-122
    - notification of changes
      - 8.5.7.3.3 ..... 8-118
      - unfreezing ..... 8.5.7.3.4 ..... 8-118
    - forms ..... 8.5.3 ..... 8-104
    - general ..... 8.5.1 ..... 8-101
    - graphics ..... 8.5.5 ..... 8-107
    - independence of screen
      - 8.5.1.1 ..... 8-101
    - multipage displays ... 8.5.1.19
      - 8.5.1.21 ..... 8-102 - 8-103
    - paper copy ..... 8.5.1.8 ..... 8-102
    - reserved area ..... 8.5.1.14 ..... 8-103
    - text ..... 8.5.2 ..... 8-103
    - usable form ..... 8.5.1.6 ..... 8-102
    - user control ..... 8.5.1.7 ..... 8-102
    - voice displays ..... 8.5.9 ..... 8-124
    - whole data sets ..... 8.5.1.4 ..... 8-102
    - wording ..... 8.5.1.10 ..... 8-102
  - Data entry ..... 8.4 ..... 8-85 - 8-101
    - data validation ..... 8.4.7 ..... 8-101
    - direct manipulation ... 8.4.4 ..... 8-97
    - editing ..... 8.4.3.7 ..... 8-96
    - forms ..... 8.4.3 ..... 8-92
    - graphics ..... 8.4.6 ..... 8-99
    - in data entry windows
      - 8.3.12.2.10 ..... 8-82
    - menus ..... 8.4.1 ..... 8-85
    - tables ..... 8.4.5 ..... 8-98
    - text ..... 8.4.2 ..... 8-89
    - windows (*see* Windows, data entry)
  - Data reduction tools ..... 11.4.2 ..... 11-9
  - Date
    - in data displays ..... 8.5.1.9 ..... 8-102
    - in system title bar .... 8.3.9.2.2 ..... 8-70
  - "Dead man" controls ..... 7.4.1.6.5 ..... 7-63
  - Decimal numbers (in user documentation)
    - 10.2.4.10.3 ..... 10-17
    - justification of ..... 8.4.3.7.3.c ..... 8-96
    - leading zeroes ..... 10.2.4.10.4 ..... 10-17
    - trailing zeroes ..... 10.2.4.10.4 ..... 10-17
  - Decision aid(s) (*see* automated decision aids)
    - automated ..... 5.2.21 ..... 5-9
    - flowcharts ..... 8.5.5.12.4 ..... 8-115
    - human responsibility 5.2.21 ..... 5-9
    - mental models ..... 5.3.6 ..... 5-12
  - Decision making (*see* also Knowledge-based aids)
    - analytic ..... 5.2.10.d ..... 5-6
    - situation awareness ... 5.1.4 ..... 5-2
  - Default(s)
    - colors in displays ..... 8.2.4.1.18 ..... 8-52
    - entries in forms (*see* also Field(s) (in forms), defaults) ..... 8.1.10.2 ..... 8-19
    - display controls ..... 8.5.6.2.2 ..... 8-115
    - 8.4.3.6 ..... 8-96
    - format for text ..... 8.4.2.3.1 ..... 8-90
    - hyphenation ..... 8.4.2.3.5 ..... 8-91
    - icon location ..... 8.1.15.1.11, 8.1.15.1.12 ..... 8-37
    - map display, after zooming
      - 8.5.8.3.7 ..... 8-121
    - option in a menu, selection of
      - 8.3.2.4.6 ..... 8-57
  - page numbering ..... 8.4.2.3.7 ..... 8-91
  - push button location . 8.3.10.1.5 ..... 8-73
  - push buttons ..... 8.1.15.2.7 ..... 8-38
  - return to normal display
    - 8.5.6.1.2 ..... 8-115
  - system-level window parameters
    - 8.3.10.1.5 ..... 8-73
  - text entry mode ..... 8.3.8.6 ..... 8-69
  - transaction controls ... 8.1.6.9 ..... 8-14
  - window location ..... 8.3.2.1.4 ..... 8-56
- Definition(s)
- in a user document .... 10.2.4.7 ..... 10-14
  - in this guide ..... 10.2.4.7.1 ..... 10-14
  - FAA practice ..... 10.2.4.7.1 ..... 10-14
  - glossary ..... 10.2.4.7.4 ..... 10-14
  - repeated definitions
    - 10.2.4.7.3 ..... 10-14
    - what to define ..... 10.2.4.7 ..... 10-14
    - when to define .... 10.2.4.7.2 ..... 10-14
  - in on-line help ..... 8.6.1.1.3 ..... 8-126
  - 8.6.1.5.12 ..... 8-129
- Degraded mode (*see* Modes of operation)
- Degraded system ..... 11.5.1.5 ..... 11-10
- "Delete"
- editing operation ..... 8.4.2.2.3 ..... 8-90
  - graphic data ..... 8.4.6.2.10 ..... 8-100
  - incoming message .... 8.3.12.5.10 ..... 8-85
  - in text windows ..... 8.3.12.3.3 ..... 8-82
- Delete key action in text entry
  - 8.4.2.2.2 ..... 8-90
  - 8.3.8.6 ..... 8-69
- Density of display ..... 8.2.1.1.5, 8.2.1.1.6 .... 8-40
- critical task sequences
    - 8.5.1.5 ..... 8-102
    - information ..... 8.5.1.5 ..... 8-102
- "Describe" (query language control operation)
  - 8.1.14.5.2.b ..... 8-34
- Design
- compatibility ..... 4.2.1 ..... 4-3
  - criteria (*see* Criteria)
  - dexterity ..... 7.6.1.1 ..... 7-103
  - disciplinary approaches
    - 5.6.2 ..... 5-18
  - entire user population
    - 7.6 ..... 7-101
    - for ADA ..... 7.6.1.1 ..... 7-103
    - funneling ..... 7.6.1.1 ..... 7-103
    - gripping ejected objects
      - 7.6.1.1 ..... 7-103
      - automatic ejection
        - 7.6.1.1 ..... 7-103
      - high function surfaces
        - 7.6.1.1 ..... 7-103
      - push button ejection
        - 7.6.1.1 ..... 7-103
        - rough handling .... 7.6.1.1 ..... 7-103
      - guidance (*see* General design guidance)
        - guidelines (*see* Guidelines)
        - inserting object ..... 7.6.1.1 ..... 7-103
        - reach for insertion and removal
          - 7.6.1.1 ..... 7-103
        - requirements (*see* General design requirements)
        - workplace ..... 9 ..... 9-1 - 9-51
  - Designing
    - adjustable seats ..... 14.2.3 ..... 14-15
    - cranes ..... 6.2.10.1 - 6.2.10.3 ..... 6-13



- Designing (continued)
- display locations ..... 14.2.3 ..... 14-15
  - for access ..... 6.4.2.2 ..... 6-24
  - guidance ..... 6.1.1.1 ..... 6-2
  - hoists ..... 6.2.10 ..... 6-13
  - jacks ..... 6.2.10 ..... 6-13
  - simplification of ..... 6.1.1.1 ..... 6-2
  - visual envelopes ..... 14.2.3 ..... 14-15
  - workplace ..... 9 ..... 9-1 - 9-51
- Design layout of consoles  
9.5.4.2 ..... 9-49
- Design limits
- approach ..... 14.1.6.3 ..... 14-15
  - 14.3.3.2.3 ..... 14-35
  - as a basis ..... 14.1.4.6 ..... 14-10
  - using ..... 14.1.2.2 ..... 14-4
  - for adjustability ..... 14.6.1 ..... 14-52
  - projecting ..... 14.1.5.2 ..... 14-13
  - using ..... 14.1.2 ..... 14-2 - 14-8
- Design principles ..... 4 ..... 4-1
- distinctive appearance ..... 4.1.5 ..... 4-2
  - distinctive interface .. 4.1.5 ..... 4-2
  - fail-safe design ..... 4.1.8 ..... 4-2
  - identifiability ..... 4.1.5 ..... 4-2
  - ruggedness ..... 4.1.9 ..... 4-2
  - safety ..... 4.1.7 ..... 4-2
  - simplicity ..... 4.1.2 ..... 4-2
  - standardization
    - for maintenance ... 4.1.4 ..... 4-2
    - hardware ..... 4.1.2 ..... 4-1
    - interface ..... 4.1.2 ..... 4-1
    - software ..... 4.1.3 ..... 4-1
- Design problem(s)
- human physical characteristics in
    - 14.3.2.1 ..... 14-16
    - involving joint movement
      - 14.3.3.2.3 ..... 14-35
      - involving two joints .. 14.3.3.2.4 ..... 14-36
    - solving ..... 14.1.4 ..... 14-9 - 14-13
    - 14.3.1.1 ..... 14-16
- Desk height of sit-stand console  
9.5.4.5 ..... 9-51
- Detent stops in controls ... 7.4.1.1.3 ..... 7-53
- push-pull controls .... 7.4.4.14.4 ..... 7-85
  - rotary selector switches
    - 7.4.4.1.7 ..... 7-67
    - thumbwheels ..... 7.4.4.3.9 ..... 7-70
    - 7.4.4.6.5 ..... 7-75
- Determining control status
- multi-sensory control status
    - 7.6.3.13 ..... 7-113
    - multi-sensory levels .. 7.6.3.13 ..... 7-113
    - pointer knobs ..... 7.6.3.13 ..... 7-113
    - speech to confirm setting
      - 7.6.3.13 ..... 7-113
      - stationary scales ..... 7.6.3.13 ..... 7-113
  - Devereaux formula ..... 10.2.3.2 ..... 10-8
- Dexterity
- minimal manual ..... 8.9.2.7 ..... 8-152
- Diagnosis
- additional information
    - 5.10 ..... 5-28
    - diagnostic aiding ..... 5.10.1 ..... 5-28
    - displays test, alphanumeric
      - 5.7.9 ..... 5-21
    - inquiry ..... 5.7.7 ..... 5-21
- Diagnostic aids
- aids ..... 6.12.3 ..... 6-82
  - integrated ..... 6.12.3.8 ..... 6-83
  - tests ..... 6.12.3.2 ..... 6-82
  - tools ..... 6.12.3.9 ..... 6-83
- Diagrams ..... 8.5.5.11 ..... 8-114
- appropriate use ..... 8.5.5.11 ..... 8-114
  - highlighting portions . 8.5.5.11.2 ..... 8-114
  - large diagrams ..... 8.5.5.11.1 ..... 8-114
  - moving among sections
    - 8.5.5.11.1 ..... 8-114
    - rotation ..... 8.5.5.11.3 ..... 8-114
- Dialog, user-computer
- types of ..... 8.1 ..... 8-1
- Dichotic presentation of auditory signals (*see also* Binaural headsets)
- 7.3.2.3.5 ..... 7-45
  - 7.3.2.3.14 ..... 7-46
- Dictionary, on-line, acronyms and abbreviations  
8.3.10.4.10 ..... 8-78
- Dimension(s) (*see also* Adjustable dimension, Clearance dimension, Limiting dimension)
- clearance ..... 9.1.2 ..... 9-1
  - for access ..... 6.4.3.2  
- 6.4.3.4 ..... 6-24 - 6-26
  - limiting ..... 9.1.2 ..... 9-1
  - physical ..... 9.1.1 ..... 9-1
  - of workplaces ..... 9.1.2 ..... 9-1
  - static
    - for working positions
      - 9.4.1 ..... 9-31
    - viewing ..... 9.1.1 ..... 9-1
- Direction of movement
- key-operated switches
    - 7.4.4.2.7 ..... 7-68
    - push-pull controls .... 7.4.4.14.6 ..... 7-87
    - thumbwheels ..... 7.4.4.3.4 ..... 7-69
    - 7.4.4.6.3 ..... 7-75
- Direct manipulation (*see also* Interaction with icons)  
8.4.4 ..... 8-97
- Directory(ies), on-line, for message addressing  
8.7.3.3.1 ..... 8-132
- Disability
- ADA ..... 7.6 ..... 7-101
  - cognitive ..... 10.6.4 ..... 10-67
  - language ..... 10.6.4 ..... 10-67
  - person with ..... 7.6 ..... 7-102
  - 8.9 ..... 8-149
  - qualified person with
    - 4.3.5 ..... 4-5
    - 7.6 ..... 7-102
    - 8.9 ..... 8-149
- Disabled
- keyboard ..... 8.1.1.25 ..... 8-4
  - pointing device ..... 8.1.1.25 ..... 8-4
- Discharging device(s) (*see also* Bleeder networks)
- 12.4.3 ..... 12-10
  - bleeders ..... 12.4.3.1 ..... 12-10
  - shorting rods
    - attaching ..... 12.4.3.4 ..... 12-11
    - providing ..... 12.4.3.2 ..... 12-10
    - storage ..... 12.4.3.4 ..... 12-11
    - use ..... 12.4.3.3 ..... 12-10
- Discriminability of colors in displays  
8.2.4.1.4 ..... 8-51
- Display(s) (*see also* Data display, Graphic data display)
- design of ..... 6.15.1.4.4 ..... 6-96

- Displays (continued)
- direct reading ..... 6.11.8 ..... 6-80
  - elements, consistency of
    - 8.2.1.2.2 ..... 8-41
  - enlarging ..... 8.9.4.1 ..... 8-153
    - 10.6.1 ..... 10-66
  - grouping ..... 6.10.3.2.1 ..... 6-75
  - high-luminance ..... 12.14.3.4 ..... 12-27
  - identification ..... 8.5.6.6.1 ..... 8-117
  - input prompts ..... 8.2.1.2.3 ..... 8-41
  - maintenance of, ..... 6.1.2.8 ..... 6-4
  - refresh rate ..... 8.9.7.1 ..... 8-156
  - selecting colors ..... 8.9.4.2 ..... 8-153
  - separation of ..... 6.10.3.2.2 ..... 6-75
  - placement on stand consoles
    - 9.5.4.4 ..... 9-51
  - structure, consistency of
    - 8.2.1.2.1 ..... 8-41
  - title ..... 8.2.1.4.1 ..... 8-41
  - transilluminated, visibility of
    - 13.4.3.1 ..... 13-10
  - update rate ..... 8.5.7.1.1 ..... 8-117
  - window, special ..... 8.9.8.3 ..... 8-157
- Display-control grouping and arrangement (*see also*  
Display, visual, location and arrangement)
- 7.1.2 ..... 7-2 - 7-4
  - alternative techniques
    - 7.1.2.19 ..... 7-4
  - control arrangement different from display  
arrangement ..... 7.1.2.10 ..... 7-3
  - control associated with more than one display
    - 7.1.2.13 ..... 7-3
  - correspondence of control-display arrangement  
with equipment arrangement
    - 7.1.2.18 ..... 7-4
  - display and controls located on separate panels
    - 7.1.2.16 ..... 7-4
  - display associated with more than one control
    - 7.1.2.14 ..... 7-3
  - display associated with switch position
    - 7.1.2.15 ..... 7-3
  - functional grouping .. 7.1.2.1 ..... 7-2
    - arrangement of groups
      - 7.1.2.3 ..... 7-2
      - 7.1.2.7 - 7.1.2.11 ..... 7-3
    - association between controls, displays, and  
consistency ..... 7.1.2.5 ..... 7-2
      - location based on order of use
        - 7.1.2.2 ..... 7-2
    - marking functional groups
      - 7.1.2.4 ..... 7-2
    - simultaneous access to control and display
      - 7.1.2.12 ..... 7-3
    - vertical and horizontal arrays
      - 7.1.2.11 ..... 7-3
- Display-control integration (*see also* display  
integration)
- 7.1 ..... 7-1 - 7-6
  - association between control and display
    - 7.1.1.1 ..... 7-1
    - 7.1.2.13 ..... 7-3
    - 7.4.1.4.6 ..... 7-61
    - 7.4.4.5.5 ..... 7-73
  - complexity and precision matched to maintainer's  
abilities ..... 7.1.1.3 ..... 7-1
  - display not obstructed
    - by control ..... 7.1.1.2 ..... 7-1
    - 7.1.2.13, 7.1.2.14 ..... 7-3
    - by maintainer ..... 7.1.1.2 ..... 7-1
    - 7.1.2.13, 7.1.2.14 ..... 7-3
  - feedback, instantaneous
    - 7.1.1.4 ..... 7-1
  - feedback with time lag between control and  
display ..... 7.1.1.5 ..... 7-1
- Display-control movement relationships
- 7.1.3 ..... 7-4 - 7-5
  - bracketing ..... 7.1.4.5 ..... 7-6
  - common linkage ..... 7.1.3.10 ..... 7-5
  - counters ..... 7.1.4.8 ..... 7-6
  - digital displays and arrays of indicator lights
    - 7.1.3.5 ..... 7-4
  - direct linkage ..... 7.1.3.9 ..... 7-5
  - display response time
    - 7.1.3.2 ..... 7-4
  - display response to control
    - 7.1.3.1 ..... 7-4
  - fixed pointer, moving scale
    - 7.1.3.6 ..... 7-5
    - circular scale ..... 7.1.3.7 ..... 7-5
    - linear scale ..... 7.1.3.8 ..... 7-5
  - knob
    - coarse setting ..... 7.1.4.3 ..... 7-6
    - fine setting ..... 7.1.4.4 ..... 7-6
  - labeling ..... 7.1.3.12 ..... 7-5
  - lever
    - coarse setting ..... 7.1.4.6 ..... 7-6
    - coarse two-dimensional setting
      - 7.1.4.7 ..... 7-6
  - minimization of adjustment time
    - 7.1.4.1 ..... 7-5
  - moving pointer
    - circular scale ..... 7.1.3.3 ..... 7-4
    - linear scale ..... 7.1.3.4 ..... 7-4
  - range of display movement
    - 7.1.4.2 ..... 7-5
    - movement direction
      - 7.1.3.11 ..... 7-5
- "Display" incoming message
- 8.3.12.5.10 ..... 8-85
- Display integration
- advanced design ..... 5.3.7 ..... 5-13
  - bigger picture ..... 5.1.19 ..... 5-8
  - comprehensible automation
    - 5.2.18 ..... 5-8
    - not combining, cluttering
      - 5.2.19 ..... 5-13
- Display rate (*see also* Update rate)
- and menu length ..... 8.1.11.1.5 ..... 8-20
- Display response time .... 7.1.3.2 ..... 7-4
- Displays, visual (*see also* CRT displays, DOT matrix  
and segmented displays, Electroluminescent  
displays, light emitting diodes, Counter, Printers,  
Plotters, and Flags) ... 7.2 ..... 7-6 - 7-42
- adjustable illumination for
    - 7.1.1.6 ..... 7-2
  - auditory warning signals
    - 7.3.2.2.5 ..... 7-44
  - coding, analog ..... 7.2.1.4.1, 7.2.1.4.4 ..... 7-8
  - coding, digital ..... 7.2.1.4.1  
- 7.2.1.4.3 ..... 7-8
  - coding, visual ..... 7.2.1.3 ..... 7-8

- Displays, visual (continued)
- consistency ..... 7.2.1.3.3 ..... 7-8
  - methods ..... 7.2.1.3.2 ..... 7-8
  - objectives ..... 7.2.1.3.1 ..... 7-8
  - consistency ..... 7.2.1.6.10 ..... 7-11
  - emergency conditions ..... 7.2.1.5.8 ..... 7-9
  - failures ..... 7.2.1.2.2, 7.2.1.2.3 ..... 7-8
  - location and arrangement
    - 7.2.1.6 ..... 7-10 - 7-12
    - accessibility ..... 7.2.1.6.2 ..... 7-10
    - frequently used displays
      - 7.2.1.6.8 ..... 7-11
    - function and sequence
      - 7.2.1.6.7 ..... 7-11
    - grouping ..... 7.2.1.6.6 ..... 7-11
    - important or critical displays
      - 7.2.1.6.9 ..... 7-11
    - location ..... 7.2.1.6.1 ..... 7-10
    - orientation and parallax
      - 7.2.1.6.3 ..... 7-10
    - reflection ..... 7.2.1.6.4 ..... 7-10
    - vibration ..... 7.2.1.6.5 ..... 7-10
  - principles ..... 7.2.1 ..... 7-6 - 7-12
    - advising and alerting
      - 7.2.1.1.11 ..... 7-7
    - alerting and warning
      - 7.2.1.1.3 ..... 7-7
      - 7.2.1.5.1 ..... 7-9
    - clear indication .... 7.2.1.1.1 ..... 7-6
    - content ..... 7.2.1.1.4 ..... 7-7
    - direct usability .... 7.2.1.1.6 ..... 7-7
    - duration ..... 7.2.1.1.9 ..... 7-7
    - legibility ..... 7.2.1.1.2 ..... 7-7
    - maintainer information combined with operator information ..... 7.2.1.1.7 ..... 7-7
    - redundancy ..... 7.2.1.2.1 ..... 7-8
    - refresh rate ..... 7.2.1.1.10 ..... 7-7
    - trademarks, company names
      - 7.2.1.1.8 ..... 7-7
  - viewing distance
    - maximum ..... 7.2.1.6.11 ..... 7-11
    - minimum ..... 7.2.1.6.12 ..... 7-11
    - minimum for CRTs
      - 7.2.1.6.14 ..... 7-12
    - preferred ..... 7.2.1.6.13 ..... 7-11
  - warning and signaling devices
    - 7.2.1.5 ..... 7-9
    - alarm parameters . 7.2.1.5.2 ..... 7-9
    - alarm prioritization
      - 7.2.1.5.4
      - 7.2.1.5.7 ..... 7-9
    - automatic clearing
      - 7.2.1.5.11 ..... 7-10
    - out-of-service alarms
      - 7.2.1.5.12 ..... 7-10
    - single purpose .... 7.2.1.5.10 ..... 7-10
    - testing alarms ..... 7.2.1.5.13 ..... 7-10
    - visual titles, legends
      - 7.2.1.5.9 ..... 7-10
- Distinguishable equipment interchangeable
- 6.3.2.2 ..... 6-15
  - noninterchangeable ... 6.3.2.4 ..... 6-15
- Distribution
- bivariate ..... 14.1.5.2 ..... 14-13
  - data, use of ..... 14.1.5 ..... 14-13 - 14-14
  - gaussian, of measurement values
    - 14.1.5.1 ..... 14-13
- Distribution lists
- message addresses .... 8.3.12.5.4 ..... 8-84
  - user-defined ..... 8.7.3.3.3 ..... 8-132
- Document, user (*see also* Documentation)
- arrangement of contents
    - 10.4 ..... 10-31
  - binding ..... 10.3.1.2 ..... 10-20
  - components of ..... 10.1.2 ..... 10-2
  - cross reference(ing) .. 10.2.1.4 ..... 10-6
  - development ..... 10 ..... 10-1
  - divisions of ..... 10.1.2.1 ..... 10-2
  - for security safeguards
    - 11.6.1 ..... 11-11
  - guides to organization
    - 10.1.2.2 ..... 10-3
  - headers ..... 10.3.2.2 ..... 10-21 - 10-22
  - headings ..... 10.1.2.2 ..... 10-3
  - footers ..... 10.3.2.2 ..... 10-21 - 10-22
  - formatting ..... 10.3 ..... 10-19 - 10-31
  - layout ..... 10.3 ..... 10-19 - 10-31
  - list orientation ..... 10.2.1.5.2 ..... 10-7
  - margins ..... 10.3.2.1 ..... 10-20 - 10-21
  - numbering of sections
    - 10.2.1.2 ..... 10-5
  - organization ..... 10.2.1 ..... 10-3 - 10-7
    - conceptual ..... 10.2.1 ..... 10-3
  - print contrast ..... 10.3.3.8.1 ..... 10-30
  - print quality ..... 10.3.3.8 ..... 10-30
  - table of contents ..... 10.1.2.3 ..... 10-3
  - tabs ..... 10.1.2.1 ..... 10-3
  - task orientation ..... 10.2.1.5.1 ..... 10-7
  - titles ..... 10.1.2.2 ..... 10-3
  - typographic cues ..... 10.1.2.2, 10.1.2.3 ..... 10-5
  - users, description of .. 10.1.1.1 ..... 10-2
  - visual hierarchy ..... 10.3.2 ..... 10-20
  - white space ..... 10.3.2.3 ..... 10-22
- Documentation (*see also* Document, user)
- automated decision aids
    - 5.2.21 ..... 5-9
  - electronic ..... 8.9.8.1 ..... 8-156
    - 10.6.1 ..... 10-66
  - electronic scanning ... 10.6.3.f ..... 10-67
  - expert users ..... 10.1.1.2 ..... 10-2
  - human interface, as part of
    - 10 ..... 10-1
  - handling of ..... 10.6.3 ..... 10-66
  - in ASCII format ..... 10.6.2 ..... 10-66
  - match to users ..... 10.1.1 ..... 10-2
  - novice users ..... 10.1.1.2 ..... 10-2
  - of security safeguards
    - 11.6 ..... 11-11
    - 11.6.2 ..... 11-11
  - printed ..... 10 ..... 10-1
  - readability of ..... 10.6.3 ..... 10-66
  - training ..... 10 ..... 10-1
  - skill level (of users) .. 10.1.1.2 ..... 10-2
  - understandability ..... 10.6.4 ..... 10-67
  - user ..... 10 ..... 10-1
- Document components (*see also* Cover page, Table of contents, Lists of exhibits, Figures, Tables, Lists, Formulas, Equations, Proceduralized instructions, Warnings, Cautions, Notes, Appendixes, Glossary, Index, User feedback forms, Tabs, Footnotes, Copyright issues, Patent issues)
- 10.4 ..... 10-31 - 10-48

- Door(s)
- alternative guidelines 9.3.4.3 ..... 9-15
  - attaching ..... 12.4.4.9 ..... 12-12
  - bearings for drawers . 7.6.1.2 ..... 7-104
  - clearances ..... 9.3.4.2.3 ..... 9-14
  - drawers & shelves (ADA)
    - 7.6.1.2 ..... 7-104
  - dual latches - avoidance
    - 7.6.1.2 ..... 7-104
  - emergency ..... 9.3.4.4 ..... 9-15
    - construction ..... 9.3.4.4.2 ..... 9-15
    - design ..... 9.3.4.4.2 ..... 9-15
  - expanded width ..... 9.3.4.2.2 ..... 9-14
  - floor to ceiling ..... 9.3.4.3.4 ..... 9-15
  - folding ..... 9.3.4.3 ..... 9-15
  - for two people ..... 9.3.4.2.5 ..... 9-14
  - handles/levers ..... 7.6.1.2 ..... 7-104
  - hinged ..... 9.3.4.2 ..... 9-13
    - dimensions ..... 9.3.4.2.1 ..... 9-13
    - in larger door ..... 9.3.4.3.1 ..... 9-15
  - knobs & lips - avoidance
    - 7.6.1.2 ..... 7-104
  - latches for closed fists
    - 7.6.1.2 ..... 7-104
  - light-proof ..... 13.4.3.2 ..... 13-10
  - number of ..... 9.3.4.2.6 ..... 9-14
  - opening direction ..... 9.3.4.2.4 ..... 9-14
  - power and push buttons
    - 7.6.1.2 ..... 7-104
  - push doors & drawers
    - 7.6.1.2 ..... 7-104
  - revolving ..... 9.3.4.3.3 ..... 9-15
  - riveted unacceptable . 6.4.1.5 ..... 6-23
  - sizes ..... 9.3.4.2.6 ..... 9-14
  - sliding ..... 9.3.4.3 ..... 9-15
    - easy opening and closing
      - 6.5.6.4 ..... 6-31
      - nonbinding ..... 6.5.6.3 ..... 6-31
      - positive locking ... 6.5.6.2 ..... 6-31
      - safe operation ..... 6.5.6.1 ..... 6-31
    - swinging ..... 9.3.4.3.2 ..... 9-15
    - to high voltage ..... 12.4.1.9, 12.4.1.10 ..... 12-8
    - unbalancing equipment
      - 6.5.1.5 ..... 6-29
  - Doorway(s) ..... 9.3.4.2 ..... 9-13
  - "Do query" (query language operation)
    - 8.1.14.5.3.c ..... 8-34
  - Dot matrix and segmented displays
    - 7.2.6 ..... 7-32
    - emitter color ..... 7.2.6.5 ..... 7-32
    - intensity control ..... 7.2.6.6 ..... 7-32
    - matrix
      - characters ..... 8.2.3.10 ..... 8-49
      - 8.3.10.4.2 ..... 8-77
    - red segmented displays
      - 7.2.7.6 ..... 7-33
    - seven-segment displays
      - 7.2.6.1 ..... 7-32
      - use of LEDs ..... 7.2.7.2 ..... 7-32
      - viewing angle ..... 7.2.6.3 ..... 7-32
      - visual angle ..... 7.2.6.3 ..... 7-32
  - Dots as field designator ... 8.4.3.2.6 ..... 8-93
  - Double click (a pointing device button)
    - 8.8.3.7.1.d ..... 8-146
  - Drag transfer (a pointing device button operation)
    - 8.4.4.1 ..... 8-97
  - Drain(s)
    - minimizing fittings .... 6.14.3.2 ..... 6-90
    - providing ..... 6.9.2.1.8 ..... 6-67
      - 6.14.3.1 ..... 6-90
      - 12.6.4 ..... 12-16
    - standardizing fittings 6.14.3.2 ..... 6-90
  - Drainage problems avoiding
    - 6.9.2.1.11 ..... 6-67
  - Draining equipment ..... 6.8.6.2 ..... 6-54
  - Drain point(s) ..... 6.14.3 ..... 6-90
    - location ..... 6.14.3.8 ..... 6-91
  - Drawer(s)
    - locks ..... 6.3.3.2.2 ..... 6-16
    - mounting in ..... 6.3.3.1 ..... 6-15
      - 6.3.3.3.3 ..... 6-17
      - 6.3.4.1.6 ..... 6-18
  - "Drop" (query language control operation)
    - 8.1.14.5.2.c ..... 8-34
  - Duration of visual signals and displays
    - 7.2.1.1.9 ..... 7-7
  - Duress entry ..... 11.3.1.14 ..... 11-7
- E**
- Echoing
    - during log on ..... 8.2.2.2.3 ..... 8-47
    - password ..... 8.2.2.2.3 ..... 8-47
  - Edges
    - exposed ..... 12.5.1.4 ..... 12-13
    - of cases ..... 6.6.1.7 ..... 6-35
    - of covers ..... 6.5.1.8 ..... 6-29
    - rounding ..... 12.5.1.4 ..... 12-13
    - sharp ..... 12.5.1.2 ..... 12-13
  - "Edit" in text windows ... 8.3.12.3.3 ..... 8-82
  - Editing
    - address field in message header
      - 8.7.3.1.2 ..... 8-131
    - commands in command languages
      - 8.1.13.18 ..... 8-30
    - data entered in forms 8.4.3.7 ..... 8-96
    - graphic data ..... 8.4.6.2 ..... 8-99
    - in data entry windows
      - 8.3.12.2.10 ..... 8-82
    - labels and overlays in map windows
      - 8.3.12.4.8 ..... 8-84
    - map displays ..... 8.5.8.4.4 ..... 8-122
      - 8.5.8.4.6 ..... 8-122
  - Editing operations (*see* "Copy," "Delete," "Move," "Print," "Undo")
    - highlighting ..... 8.4.2.2.7 ..... 8-90
    - search and replace ... 8.4.2.2.5 ..... 8-90
    - searching text ..... 8.4.2.2.4 ..... 8-90
    - units of text ..... 8.4.2.2.6 ..... 8-90
  - Effective radiance ..... 12.14.2 ..... 12-24
  - Effective temperature
    - deriving ..... 13.3.2 ..... 13-6
    - limits ..... 13.3.1 ..... 13-5
      - maximum ..... 13.3.5 ..... 13-6
      - minimum ..... 13.3.4 ..... 13-6
    - ranges ..... 13.3.6 ..... 13-6
  - "e.g.," (use of in user documentation)
    - 10.2.4.8.8 ..... 10-16
  - Electrical connectors ..... 6.8.5 ..... 6-51
    - insertion force ..... 6.8.5.1.9 ..... 6-51
    - selection of ..... 6.8.5.1.2 ..... 6-51
    - self-locking ..... 6.8.5.1.8 ..... 6-51

Electrical connectors (continued)  
 type (*see also* Plug-in connector, wire connection)  
 Electrical equipment  
 safety ..... 12.4.1.8 ..... 12-8  
 Electrical equipment identification  
 marking ..... 6.3.5.1.1 ..... 6-19  
 12.16 ..... 12-29  
 Electrical hazards ..... 12.4 ..... 12-5 - 12-13  
 effects of current ..... 12.4 ..... 12-5  
 Electrical installations ..... 12.4.1.18 ..... 12-9  
 Electrical symbols (in user documentation)  
 10.2.4.13.1 ..... 10-18  
 Electroluminescent displays  
 7.2.8 ..... 7-33  
 alphanumeric character and symbol size  
 7.2.8.1 ..... 7-33  
 Electrolyte, handling ..... 12.9.1, 12.9.3,  
 12.9.4 ..... 12-19  
 Electronic checklist(s) ..... 5.2.17 ..... 5-8  
 Electronic symbols (in user documentation)  
 10.2.4.13.1 ..... 10-18  
 Elements  
 screen  
 appearance ..... 8.2.1.2.2 ..... 8-41  
 arrangement ..... 8.2.1.4.5 ..... 8-43  
 consistent location  
 8.2.1.2.2 ..... 8-41  
 layout ..... 8.2.1.4.3 ..... 8-43  
 Elevation, changes in ..... 9.3.4.4.3 ..... 9-16  
 Elevators ..... 9.3.3 ..... 9-10  
 providing ..... 9.3.5.1.3 ..... 9-20  
 safety features ..... 9.3.3.5.1 ..... 9-12  
 9.3.3.5.2 ..... 9-13  
 Ellipsis, distinguishing mark for menu options  
 8.4.1.1.5 ..... 8-86  
 8.3.7.3.5.b ..... 8-67  
 Embedded training (*see* Training)  
 Emergency (*see* Modes of operation)  
 Emergency alarms  
 fire protection ..... 6.12.1.1 ..... 6-82  
 Emergency conditions  
 design compatibility .. 4.2.1.a ..... 4-3  
 telephone switching .. 7.3.5.5.6 ..... 7-52  
 visual signals ..... 7.2.1.5.8 ..... 7-9  
 Emergency controls and displays, location of  
 7.1.1.8 ..... 7-2  
 Emergency equipment, dimensions for  
 14.1.2.7 ..... 14-7  
 Emergency exits  
 ceiling height ..... 9.3.4.2.1 ..... 9-13  
 9.3.4.4.2 ..... 9-15  
 construction ..... 12.2.1.6 ..... 12-2  
 design ..... 9.3.4.4.2 ..... 9-15  
 12.2.1.6 ..... 12-2  
 guarding ..... 9.3.4.6.3 ..... 9-19  
 headroom ..... 9.3.4.2.1 ..... 9-13  
 9.3.4.4.2 ..... 9-15  
 OSHA ..... 9.3.4.4.1 ..... 9-15  
 ramps ..... 9.3.4.4.3 ..... 9-16  
 signs ..... 9.3.4.4.4 ..... 9-16  
 stairs ..... 9.3.4.4.3 ..... 9-16  
 Emergency signals  
 duration ..... 7.3.4.2.5 ..... 7-48  
 maximum intensity .. 7.3.2.3.2 ..... 7-45  
 signs ..... 9.3.4.4.4 ..... 9-16  
 Emergency systems ..... 4.2.3.d ..... 4-4  
 Emphasis (*see* Typographic emphasis)

Encryption  
 automatic ..... 11.5.2.2 ..... 11-10  
 providing ..... 11.5.2.2 ..... 11-10  
 transparent to user .... 11.5.2.2 ..... 11-10  
 "End," user interrupt ..... 8.1.4.5 ..... 8-9  
 "Enter" action, explicit  
 command editing ..... 8.1.5.3.1 ..... 8-13  
 command execution .. 8.1.13.19 ..... 8-30  
 command stacking .... 8.1.13.5 ..... 8-29  
 completion of control entry or action  
 8.1.1.5 ..... 8-2  
 data entry ..... 8.1.6.12 ..... 8-15  
 error correction ..... 8.1.5.1.8 ..... 8-11  
 error message ..... 8.4.3.8.2.b ..... 8-97  
 8.4.3.8.3.b ..... 8-97  
 form completion ..... 8.4.3.7.6 ..... 8-97  
 moving a window using the keyboard  
 8.3.5.4 ..... 8-62  
 not for confirmation .. 8.1.5.1.10 ..... 8-11  
 opening an icon ..... 8.3.5.12 ..... 8-63  
 resizing a window using the keyboard  
 8.3.5.7 ..... 8-63  
 selecting an exclusive button  
 8.1.15.3.2 ..... 8-38  
 user control in windows  
 8.1.1.21 ..... 8-3  
 Entrances ..... 9.3.4 ..... 9-13  
 Entry, invalid attempt ..... 11.2.5 ..... 11-4  
 Envelopes (*see* Reach envelopes, Visual envelopes)  
 Environment (*see also* Acoustic environment)  
 13 ..... 13-1 - 13-17  
 acceleration ..... 4.2.2.b ..... 4-3  
 acoustical ..... 6.4.5.8 ..... 6-27  
 13.5.2.2 ..... 13-16  
 artificial illumination  
 4.2.2.c ..... 4-3  
 atmospheric conditions  
 4.2.2.a ..... 4-3  
 4.2.2.b ..... 4-3  
 blast ..... 13.1.1 ..... 13-1  
 extremes ..... 4.2.2.b ..... 4-3  
 impact forces ..... 4.2.2.b ..... 4-3  
 noise ..... 4.2.2.b ..... 4-3  
 8.5.9.2.4 ..... 8-124  
 shock ..... 4.2.2.b ..... 4-3  
 vibration ..... 4.2.2.b ..... 4-3  
 Environmental compatibility  
 of auditory signals .... 8.5.4.3.5 ..... 8-105  
 of speech signals ..... 8.5.9.2.4 ..... 8-124  
 Equations (in user documentation)  
 10.4.7 ..... 10-41 - 10-42  
 format ..... 10.4.7.3 ..... 10-42  
 identification ..... 10.4.7.2 ..... 10-42  
 location ..... 10.4.7.1 ..... 10-41  
 Equipment (*see also* Test equipment)  
 accessibility ..... 12.3.2 ..... 12-5  
 adjustments ..... 6.3.1.4 ..... 6-14  
 carried  
 effects on measurements  
 14.1.4.8 ..... 14-12  
 coloring ..... 12.3.7 ..... 12-5  
 connecting ..... 6.3.1.3 ..... 6-14  
 critical ..... 6.3.4.2.1 ..... 6-18  
 design of ..... 6.2.1.1 ..... 6-5  
 12.4.1.5 ..... 12-7  
 12.11.3 ..... 12-20  
 dividing into modules  
 6.1.2.7 ..... 6-3

- Equipment (continued)
- environmental conditions
    - 13.1 ..... 13-1
    - in explosive atmosphere
      - 12.13.3 ..... 12-23
  - edges ..... 12.5.1.4 ..... 12-13
  - existing, use of ..... 6.1.3.1 ..... 6-4
  - failure ..... 6.1.2.3 ..... 6-3
  - frequently moved ..... 6.3.3.1.1 ..... 6-15
  - grouping ..... 6.3.4.2.3 ..... 6-19
  - high-temperature ..... 12.5.2.4 ..... 12-16
  - identification ..... 6.3.5.1.1 ..... 6-19
  - independence ..... 6.1.2.5 ..... 6-3
    - 6.3.1.2 ..... 6-14
  - installation of ..... 6.2.3.1 ..... 6-7
    - 6.3.1.5 ..... 6-14
  - maintenance ..... 6 ..... 6-1
  - mounting ..... 6.3.1.3 ..... 6-14
    - 6.3.4.1.6 ..... 6-18
  - noninterchangeable ... 6.1.3.3 ..... 6-4
  - partial failure of ..... 6.1.2.3 ..... 6-3
  - positioning of ..... 6.3.4 ..... 6-17
  - redundancy of ..... 6.1.2.2 ..... 6-3
  - releasing gases ..... 12.6.1 ..... 12-16
  - removal of ..... 6.3.4.1.8 ..... 6-18
    - 6.3.4.1.9 ..... 6-18
  - shape of ..... 6.2.3.1 ..... 6-7
  - size of ..... 6.2.3.1 - 6.2.3.2 ..... 6-7
  - stability ..... 12.3.3 ..... 12-5
  - stacking ..... 6.3.4.1.5 ..... 6-18
  - self-checking ..... 6.15.1.3.3 ..... 6-95
  - self-powered ..... 12.4.5.4 ..... 12-13
  - surfaces, contact plates on
    - 9.3.3.1.3 ..... 9-11
  - unbalanced ..... 6.5.1.5 ..... 6-29
  - with wheels ..... 12.3.4 ..... 12-5
- Equivalence
- of abbreviated and complete entry
    - 8.1.11.7.5 ..... 8-25
  - of input devices for selecting menu options
    - 8.4.1.6.1 ..... 8-88
  - of input devices for text operations
    - 8.4.2.1.3 ..... 8-89
  - of keyboard and function keys
    - 8.8.1.7 ..... 8-139
  - of keyboard and pointing device
    - 8.8.1.8 ..... 8-139
  - of upper and lower case
    - 8.1.1.16 ..... 8-3
- "Erase" (query language search operation)
  - 8.1.14.5.1.b ..... 8-33
- Error (see also human error)
- hazard analyses ..... 5.2.117 ..... 5-8
  - modes of operation ... 5.2.18 ..... 5-8
  - resistant design (see human error)
  - tolerant design (see human error)
- Error correction  
(in human-computer interfaces)
- cursor location ..... 8.1.5.2.4,
    - 8.1.5.2.11 ..... 8-12
  - errors only ..... 8.1.5.2.10 ..... 8-12
  - explicit "Enter" action
    - 8.1.5.1.8 ..... 8-11
  - flexible "Go back" ... 8.1.5.1.11 ..... 8-11
  - immediate ..... 8.1.5.1.5 ..... 8-11
    - 8.1.5.1.12 ..... 8-11
  - in a query language ... 8.1.14.1.10 ..... 8-32
    - in stacked commands 8.1.5.3.4 ..... 8-13
    - prompting for ..... 8.1.5.1.6 ..... 8-11
    - return to main interaction
      - 8.1.5.1.9 ..... 8-11
- Error detection (in human computer interfaces)
- in a query language ..... 8.1.14.1.10 ..... 8-32
  - in stacked commands . 8.1.5.3.6 ..... 8-13
- Error management in user-computer interaction
- 8.1.5 ..... 8-10 - 8-13
  - confirmation of destructive action
    - 8.1.5.1.9 ..... 8-11
  - duration of error notification
    - 8.1.5.1.9 ..... 8-11
  - fast detection ..... 8.1.5.1.4 ..... 8-11
  - "Go back" ..... 8.1.5.1.11 ..... 8-11
  - immediate correction 8.1.5.1.5 ..... 8-11
    - 8.1.5.1.12 ..... 8-11
  - in fields in forms ..... 8.4.3.8 ..... 8-97
  - prompting for correction
    - 8.1.5.1.6 ..... 8-11
  - return to main interaction
    - 8.1.5.1.9 ..... 8-11
  - system detection of error type
    - 8.1.5.1.3 ..... 8-10
  - "Undo" ..... 8.1.5.1.12 ..... 8-11
  - user-detected errors . 8.1.5.1.1 ..... 8-10
- Error messages (see Messages, error)
- Escape ..... 4.2.3.d ..... 4-4
- Escape hatch(es) ..... 14.1.2.5 ..... 14-7
- Examples (in user documentation)
- 10.1.2.4 ..... 10-3
- Exhibits (in this HFDG)
- 1.4.2.4 ..... 1-4
  - 10.4.3 ..... 10-35
- Exit(s)
- alternative ..... 9.3.4.3.1 ..... 9-15
  - ceiling height ..... 9.3.4.2.1 ..... 9-13
    - 9.3.4.4.2 ..... 9-15
  - design ..... 9.3.4.1.2 ..... 9-13
  - emergency ..... 9.3.4.4 ..... 9-15
  - guarding ..... 9.3.4.6.3 ..... 9-19
  - headroom ..... 9.3.4.2.1 ..... 9-13
    - 9.3.4.4.2 ..... 9-15
  - means of egress ..... 12.2.1.6 ..... 12-2
  - OSHA ..... 9.3.4.4.1 ..... 9-15
  - ramps ..... 9.3.4.4.3 ..... 9-16
  - signs ..... 9.3.4.4.4 ..... 9-16
  - stairs ..... 9.3.4.4.3 ..... 9-16
  - "Exit" ..... 9.3.4 ..... 9-13
    - availability of ..... 8.2.2.3.2 ..... 8-47
    - log off ..... 8.2.2.3.2 ..... 8-47
    - user interrupt ..... 8.1.4.5 ..... 8-9
- Experienced user(s)
- bypassing "normal" user guidance
    - 8.6.1.1.9 ..... 8-126
  - content of large-screen displays
    - 7.2.5.1.6 ..... 7-29
  - documentation for ..... 10.1.1.2 ..... 10-2
  - interactive control systems for
    - 8.1.1.2 ..... 8-1
  - needs for user guidance
    - 8.6.b ..... 8-125
  - query language commands
    - 8.1.14.6.7 ..... 8-36
  - shortcuts to bypass menu structure
    - 8.1.11.1.11 ..... 8-21

Experience, user's level of  
 data display format ... 8.5.5.1.3 ..... 8-108  
 query language ..... 8.1.14.6 ..... 8-35 - 8-36  
 Expert user(s) (*see* Experienced user(s))  
 Expert review HFDDG foreword ..... i  
 reviewer numbers ..... Appendix B ..... B-1  
 Explicit user action (*see* "Enter" action, explicit)  
 Explosion hazards ..... 12.13 ..... 12-23  
 materials producing .. 12.13.5 ..... 12-24  
 risk of explosion ..... 12.13.4 ..... 12-24  
 Explosion-proof equipment  
 12.4.1.15 ..... 12-9  
 Exposure  
 record(s) ..... 13.2.8 ..... 13-3  
 to ultraviolet ..... 12.14.1.1 ..... 12-24  
 Extension(s)  
 avoiding ..... 6.3 ..... 6-13  
 full, of equipment ..... 6.3.4.1.6 ..... 6-18  
 Extension cables ..... 6.9.1.6 ..... 6-63  
 function ..... 6.9.1.6.2 ..... 6-63  
 providing ..... 6.9.1.3.11 ..... 6-61  
 storage for ..... 6.9.1.6.5 ..... 6-63  
 test points ..... 6.9.1.7.4 ..... 6-64  
 use of ..... 6.9.1.6.1, 6.9.1.6.3 ..... 6-63  
 Eye(s)  
 flushing ..... 12.9.3, 12.9.4 ..... 12-19  
 protection ..... 12.9.1 ..... 12-18  
 12.14.3.3 ..... 12-27  
 12.15.3 ..... 12-29  
 Eye positions  
 determining ..... 14.2.3 ..... 14-15  
 Eye reference point ..... 7.2.1.6.11  
 - 7.2.1.6.14 ..... 7-11 - 7-12

**F**

Face shield ..... 12.9.1 ..... 12-18  
 Fail-safe  
 brakes ..... 9.3.3.5.2 ..... 9-13  
 design ..... 4.1.8 ..... 4-2  
 features ..... 6.15.1.2.5 ..... 6-95  
 12.4.1.5 ..... 12-7  
 Failure detection ..... 6.12 ..... 6-81 - 6-83  
 Failure indicators (*see* Indicators, failure)  
 Failure isolation ..... 6.12 ..... 6-81 - 6-83  
 Failure mode and effects  
 analysis ..... 53.3d ..... 5-10  
 5,7,7 ..... 5-21  
 Fall protection ..... 9.3.3 ..... 9-10  
 False Alarms  
 negative aspects ..... 5.7.11 ..... 5-23  
 number of ..... 11.2.4 ..... 11-4  
 11.5.1.3 ..... 11-9  
 Fastener(s) ..... 6.5.8 ..... 6-32  
 6.7 ..... 6-38 - 6-47  
 captive ..... 6.2.9.3 ..... 6-13  
 6.5.8.4 ..... 6-32  
 choosing ..... 6.7 ..... 6-38  
 distinguishable ..... 6.7.1.9, 6.7.1.10 ..... 6-39  
 guide action ..... 6.4.1.5 ..... 6-23  
 holes for ..... 6.5.8.9 ..... 6-32  
 6.6.4.9 ..... 6-36  
 6.7.1.7 ..... 6-39  
 indicator ..... 6.5.8.8 ..... 6-32  
 6.6.4.8 ..... 6-36  
 6.7.1.6 ..... 6-39

interchangeability ..... 6.5.8.3 ..... 6-32  
 6.7.1.3 ..... 6-38  
 length ..... 6.5.8.10 ..... 6-32  
 location ..... 6.7.1.11 ..... 6-39  
 number of ..... 6.5.8.2 ..... 6-32  
 6.7.1.2 ..... 6-38  
 6.7.2 ..... 6-40  
 minimizing ..... 6.7.2.3 ..... 6-40  
 6.7.2.4 ..... 6-40  
 per equipment ..... 6.7.2.2 ..... 6-40  
 on covers ..... 6.5.1.2 ..... 6-28  
 operation ..... 6.5.8.2 ..... 6-32  
 6.5.8.7 ..... 6-32  
 6.7.1.2 ..... 6-38  
 6.7.1.5 ..... 6-38  
 painting ..... 6.7.1.13 ..... 6-40  
 pin and hook ..... 6.5.8.11 ..... 6-33  
 pins . 6.7.3.7.5 ..... 6-46  
 providing ..... 6.15.7.2 ..... 6-100  
 quick-action ..... 6.5.8.5 ..... 6-32  
 requirements ..... 6.7.1.8 ..... 6-39  
 rivets (*see also* Captive fasteners)  
 6.7.3.5.6 ..... 6-44  
 self-aligning ..... 6.5.8.6 ..... 6-32  
 6.6.4.6 ..... 6-36  
 6.7.1.4 ..... 6-38  
 strength of ..... 6.7.1.12 ..... 6-40  
 torque on ..... 6.7.1.14 - 6.7.1.15 ..... 6-40  
 type of (*see* Nuts and bolts, Quick fastening  
 devices) ..... 6.7.3 ..... 6-40  
 cotter pins and keys  
 6.7.3.5.2 ..... 6-44  
 cross-recess ..... 6.7.3.3.3 ..... 6-42  
 disallowed ..... 6.7.3.5.1 ..... 6-44  
 hexagonal ..... 6.7.3.3.6 ..... 6-43  
 6.7.3.3.7 ..... 6-43  
 high-torque ..... 6.7.3.3.6 ..... 6-43  
 internal-wrenching  
 6.7.3.3.4 ..... 6-43  
 6.7.3.3.5 ..... 6-43  
 latches and catches  
 6.7.3.4 ..... 6-43  
 location ..... 6.7.1.11 ..... 6-39  
 low-torque ..... 6.7.3.3.7 ..... 6-43  
 order of preference  
 6.7.3 ..... 6-40  
 pins and hooks ..... 6.7.3.5.4 ..... 6-44  
 straight-slot ..... 6.7.3.3.3 ..... 6-42  
 retainer rings ..... 6.7.3.5.3 ..... 6-44  
 Fault detection (*see* Models)  
 automation of ..... 6.1.2.4 ..... 6-3  
 positive ..... 6.12.3.4 ..... 6-83  
 rapid ..... 6.12.3.4 ..... 6-83  
 without ambiguity ..... 6.12.3.8 ..... 6-83  
 without disassembly .. 6.12.3.8 ..... 6-83  
 Fault isolation ..... 6.1.2.4 ..... 6-3  
 6.1.2.7 ..... 6-3  
 6.10.2.2.2.b ..... 6-73  
 6.12.3.1 ..... 6-82  
 in portable equipment  
 6.12.3.9 ..... 6-83  
 positive ..... 6.12.3.4 ..... 6-83  
 rapid ..... 6.12.3.4 ..... 6-83  
 without ambiguity ..... 6.12.3.8 ..... 6-83  
 without disassembly .. 6.12.3.8 ..... 6-83  
 Fault localization ..... 6.1.1.1 ..... 6-2  
 6.1.2.7 ..... 6-3

- Feedback
  - foot-operated switches
    - 7.4.3.5 ..... 7-65
  - in user-computer action
    - 8.1.3.2 ..... 8-7
    - alarms and alerts ... 8.1.3.5.3 ..... 8-8
    - completion of processing
      - 8.1.3.2.4 ..... 8-7
    - entry acknowledgement
      - 8.1.3.2.1 ..... 8-7
    - function key activation
      - 8.1.12.4 ..... 8-27
    - immediate, in windows
      - 8.1.1.22 ..... 8-3
    - instantaneous from control to display
      - 7.1.1.4 ..... 7-1
    - menu selection ..... 8.1.11.7.4 ..... 8-25
    - messages, periodic
      - 8.1.3.2.2 ..... 8-7
    - message transmission
      - 8.3.12.5.7 ..... 8-85
      - 8.7.5.2.1 ..... 8-133
    - periodic feedback . 8.1.3.2.2 ..... 8-7
    - routine ..... 8.1.3.6.1 ..... 8-9
    - search time for data base query
      - 8.1.14.5.5 ..... 8-35
    - speech input ..... 8.8.4.3.2 ..... 8-148
    - system interrupts .. 8.1.3.3.1 ..... 8-7
    - touch panel display
      - 8.8.4.2.7 ..... 8-148
    - transilluminated displays
      - 7.2.2.1.3 ..... 7-14
    - when using light pen
      - 8.8.3.4.4 ..... 8-143
  - keyboards ..... 7.4.4.9.7 ..... 7-79
  - legend switches ..... 7.4.4.11.3 ..... 7-81
  - log on ..... 11.3.2.5 ..... 11-8
  - push buttons ..... 7.4.4.8.5 ..... 7-78
  - rocker switches ..... 7.4.4.12.5 ..... 7-82
  - slide switches ..... 7.4.4.13.4 ..... 7-85
  - toggle switches ..... 7.4.4.10.4 ..... 7-79
- Feedback forms (*see* user feedback forms)
- Fields (in forms) ..... 8.4.3.2 ..... 8-92 - 8-93
  - appearance ..... 8.4.3.2.1 ..... 8-92
  - 8.5.3.1 ..... 8-104
  - defaults ..... 8.4.3.6 ..... 8-96
  - automatic display . 8.4.3.6.2 ..... 8-96
  - replacement of ..... 8.4.3.6.3 ..... 8-96
  - when to use ..... 8.4.3.6.1 ..... 8-96
  - entering data ..... 8.4.3.7 ..... 8-96
  - justification of entries
    - 8.4.3.7.3 ..... 8-96
  - leading and trailing zeros
    - 8.4.3.7.2 ..... 8-96
  - unfilled spaces ..... 8.4.3.7.1 ..... 8-96
  - error management ..... 8.4.3.8 ..... 8-97
  - easy correction ..... 8.4.3.8.1 ..... 8-97
  - help ..... 8.4.3.1.3 ..... 8-92
  - in data entry windows
    - 8.3.12.2.1 ..... 8-81
    - 8.3.12.2.6 ..... 8-82
  - in message handling windows
    - 8.3.12.5.2 ..... 8-84
  - intrafield separators ... 8.4.3.2.7 ..... 8-93
  - in windows ..... 8.3.3.2 ..... 8-58
  - scrolling fields ..... 8.3.3.2.3 ..... 8-58
  - when to use ..... 8.3.3.2.2 ..... 8-58
- labels
  - consistent location
    - 8.4.3.3.6 ..... 8-94
  - descriptive ..... 8.4.3.3.2 ..... 8-93
  - distinct from other information
    - 8.4.3.3.4 ..... 8-94
  - for every data field
    - 8.4.3.3.1 ..... 8-93
  - noneditable ..... 8.4.3.3.9 ..... 8-94
  - terminator ..... 8.4.3.3.5 ..... 8-94
  - terms ..... 8.4.2.3.3 ..... 8-91
  - unit of measurement
    - 8.4.3.3.7 ..... 8-94
    - 8.4.3.3.8 ..... 8-94
  - length ..... 8.4.3.2.2 ..... 8-92
  - "next" field ..... 8.4.3.5.6 ..... 8-95
  - omitted entries ..... 8.4.3.8.3 ..... 8-97
  - deliberate omissions
    - 8.4.3.8.4 ..... 8-97
  - overwriting delineators
    - 8.4.3.2.3 ..... 8-92
  - "previous" field ..... 8.4.3.5.6 ..... 8-95
  - required ..... 8.4.3.2.5 ..... 8-93
  - required distinguishable from optional
    - 8.4.3.2.6 ..... 8-93
  - unacceptable entries ... 8.4.3.8.3 ..... 8-97
  - unfilled portion ..... 8.4.3.2.4 ..... 8-92
- Figures (in this HFDG) ... 1.4.2.4, E1.4.2 ..... 1-4,1-5
- Figures (in user documentation)
  - 10.1.2.4 ..... 10-2
  - 10.4.4 ..... 10-35 - 10-38
- alphanumeric information
  - 10.4.4.4.5 ..... 10-37
- callouts ..... 10.4.4.5.2 ..... 10-37
- color ..... 10.4.4.4.7 ..... 10-37
- content ..... 10.4.4.5 ..... 10-37
- amount of detail ... 10.4.4.5.1 ..... 10-37
- decorative elements in
  - 10.4.4.4.4 ..... 10-36
- drawing, computer aids
  - 8.5.5.3.11 ..... 8-109
- footnotes
  - identification ..... 10.4.14.2 ..... 10-48
  - location ..... 10.4.14.2 ..... 10-48
- identification ..... 10.4.4.2 ..... 10-35
- caption ..... 10.4.4.2.2 ..... 10-36
- number ..... 10.4.4.2.1 ..... 10-35
- title ..... 10.4.4.2.1 ..... 10-35
- line width ..... 10.4.4.4.6 ..... 10-37
- location ..... 10.4.4.3 ..... 10-36
- consistent location
  - 10.4.4.3.3 ..... 10-36
- following first reference
  - 10.4.4.3.1 ..... 10-36
- preferred ..... 10.4.4.3.2 ..... 10-36
- orientation ..... 10.4.4.6 ..... 10-37
- alternate ..... 10.4.4.6.1 ..... 10-37
- preferred ..... 10.4.4.6.2 ..... 10-38
- oversize ..... 10.4.4.7 ..... 10-38
- captions for ..... 10.4.4.7.2 ..... 10-38
- facing pages ..... 10.4.4.7.1 ..... 10-38
- foldout pages ..... 10.4.4.7.3 ..... 10-38
- relationship to text .... 10.4.4.1.2 ..... 10-35
- style ..... 10.4.4.4 ..... 10-36
- consistent ..... 10.4.4.4.1 ..... 10-36
- 10.4.4.4.3 ..... 10-36
- line drawings ..... 10.4.4.4.2 ..... 10-36



Figures (in user documentation) (continued)		
minimal distraction		
10.4.4.4.4 .....	10-36	
photographs .....	10.4.4.4.2 .....	10-36
preferred .....	10.4.4.4.2 .....	10-36
when to use .....	10.4.4.1.1 .....	10-35
Filter(s)		
for CRT displays .....	7.2.4.4.4 .....	7-25
for glare control .....	7.2.4.4.1 .....	7-25
for infrared energy .....	12.14.3.3 .....	12-27
for map displays .....	8.5.8.5.3 .....	8-123
loudspeaker .....	7.3.5.2.4 .....	7-50
Finding controls .....	7.6.3.10 .....	7-112
adjacent objects .....	7.6.3.10 .....	7-112
logical arrangement(s)		
7.6.3.10 .....	7-112	
redundant speech .....	7.6.3.10 .....	7-112
ridges around flat buttons		
7.6.3.10 .....	7-112	
shape and texture .....	7.6.3.10 .....	7-112
space between .....	7.6.3.10 .....	7-112
Finding information in this HFDDG		
1.4.2 .....	1-4	
Finger curl .....	6.2.5.3.3 .....	6-11
Fingerprinting, as identification authentication		
11.3.3 .....	11-8	
Fire extinguishers		
location .....	12.11.4 .....	12-20
selection .....	12.11.5 .....	12-20
use .....	12.11.5 .....	12-20
Fire protection .....	6.12.1.1 .....	6-82
12.11 .....	12-20 - 12-21	
criteria .....	12.11.6 .....	12-21
potential .....	12.11.1 .....	12-20
Fittings, standardized .....	6.9.2.1.7 .....	6-67
Fixed pointer scales ( <i>see</i> Scales, fixed pointer)		
Flags, as visual displays ..	7.2.9.4 .....	7-37
characteristics and ratings		
7.2.9 .....	7-38	
contrast .....	7.2.9.4.4 .....	7-41
legend .....	7.2.9.4.6 .....	7-41
malfunction indication		
7.2.9.4.5 .....	7-41	
mounting .....	7.2.9.4.2 .....	7-41
snap action .....	7.2.9.4.3 .....	7-41
test provision .....	7.2.9.4.7 .....	7-42
when to use .....	7.2.9.4.1 .....	7-41
10.2.4.3.4 .....	10-13	
Flammable		
explosive .....	12.11.3 .....	12-20
gases .....	12.11.3 .....	12-20
liquids .....	12.6.6 .....	12-16
materials .....	12.11.2 .....	12-20
12.11.6 .....	12-21	
"Flammable" (use of in user documentation)		
Flash coding .....	8.5.4.6 .....	8-106
acknowledgement .....	8.5.4.6.5 .....	8-107
flash rate .....	8.5.4.6.2 .....	8-106
in windows .....	8.2.1.11.2 .....	8-46
limited use .....	8.5.4.6.1 .....	8-106
second flash rate .....	8.5.4.6.3 .....	8-107
symbol, not object .....	8.5.4.6.4 .....	8-107
text cursor .....	8.3.8.1 .....	8-68
Flashing lights in transilluminated displays		
7.2.2.1.21 .....	7-15	
Flashing red		
emergency conditions		
7.2.1.5.8 .....	7-9	
reserved meaning in displays		
8.5.4.1.5 .....	8-104	
Flash rate .....	8.9.7.1 .....	8-156
Flesch formula .....	10.2.3.2.1 .....	10-7
Flexible hose, use of .....	6.9.2.1.2 .....	6-66
Flexible tubing, use of .....	6.9.2.1.1 .....	6-66
Flicker		
color coded symbols ..	8.2.4.3.4 .....	8-54
CRT displays .....	7.2.4.1.1 .....	7-23
Floor hatch(es) .....	9.3.4.6.3 .....	9-19
Floor load limits .....	9.2.1.12 .....	9-4
Floor space		
aisles .....	9.2.1.12 .....	9-4
cleanliness .....	9.2.1.12 .....	9-4
electrical equipment ..	9.2.1.12 .....	9-4
equipment racks .....	9.2.1.12 .....	9-4
load limits .....	9.2.1.12 .....	9-4
material handling .....	9.2.1.12 .....	9-4
non skid .....	9.3.1.3 .....	9-8
9.3.3.3.1 .....	9-11	
passageway floors .....	9.2.1.12 .....	9-4
9.3.3.3.1 .....	9-11	
protrusions .....	9.2.1.12 .....	9-4
storage space .....	9.2.1.12 .....	9-4
work space .....	9.2.1.12 .....	9-4
Flowcharts .....	8.5.5.12 .....	8-114
appropriate use .....	8.5.5.12 .....	8-114
as decision aids .....	8.5.5.12.4 .....	8-115
consistency .....	8.5.5.12.2 .....	8-115
design principles .....	8.5.5.12.1 .....	8-114
highlighting .....	8.5.5.12.3 .....	8-115
orientation .....	8.5.5.12.5 .....	8-115
symbols in user documentation		
10.2.4.14.1 .....	10-18	
Fluid(s)		
avoiding spraying .....	6.9.2.1.8 .....	6-67
12.6.4 .....	12-16	
Fluid line connectors .....	6.8.6 .....	6-54
location of .....	6.9.2.1.8 .....	6-67
Foldout pages .....	10.3.2.8 .....	10-25 - 10-26
as separate series .....	10.3.2.8.7 .....	10-26
fold out to right .....	10.3.2.8.2 .....	10-25
location .....	10.3.2.8.6 .....	10-25
minimize use .....	10.3.2.8.1 .....	10-25
oversize figures .....	10.4.4.7.3 .....	10-38
oversize tables .....	10.4.5.7.3 .....	10-40
right-hand pages .....	10.3.2.8.3 .....	10-25
to avoid cross reference		
10.2.1.4.1 .....	10-6	
visibility of entire exhibit		
10.3.2.8.5 .....	10-25	
visibility of page number and caption		
10.3.2.8.4 .....	10-25	
Font ( <i>see</i> Type style)		
Foot-operated controls ( <i>see also</i> Foot-operated switches) .....	7.3.5.4.5, 7.3.5.4.6 .....	7-51
7.4.2 .....	7-63	
compatibility with footwear		
7.4.2.4 .....	7-64	
operation .....	7.4.2.3 .....	7-63
when not to use .....	7.4.2.2 .....	7-63
when to use .....	7.4.2.1 .....	7-63

- Foot-operated switches (*see also* Foot-operated controls) ..... 7.4.3 ..... 7-64
- feedback ..... 7.4.3.5 ..... 7-65
  - operation ..... 7.4.3.3 ..... 7-65
  - specifications ..... 7.4.3.1 ..... 7-64
  - wet or slippery conditions
    - 7.4.3.4 ..... 7-65
    - when to use ..... 7.4.3.2 ..... 7-65
- Footers (in this HFDG) ... 1.4.2.3 ..... 1-4
- Footers (in user documentation)
  - 10.3.2.2 ..... 10-21 - 10-22
  - location information .. 10.3.2.2.1 ..... 10-21
  - location of information elements
    - 10.2.2.3 ..... 10-21
  - margins ..... 10.3.2.2.4 ..... 10-22
  - use of ..... 10.3.2.2.2 ..... 10-21
- Footnotes (in user documentation)
  - 10.4.14 ..... 10-45 - 10-48
  - additional rules ..... 10.4.14.4 ..... 10-48
  - consecutive numbering of
    - 10.4.14.2 ..... 10-48
  - identification of ..... 10.4.14.2 ..... 10-48
  - in figures ..... 10.4.14.2, 10.4.14.3 . 10-48
  - in tables ..... 10.4.14.2, 10.4.14.3 . 10-48
  - location ..... 10.4.14.2 ..... 10-48
  - minimize use of ..... 10.4.14.1 ..... 10-45
  - reference in text ..... 10.4.14.2 ..... 10-48
- Footrests ..... 9.4.4.5 ..... 9-42
- 9.4.4.9 ..... 9-43
  - 9.5.4.5 ..... 9-51
- Footwear
  - compatibility with foot-operated controls
    - 7.4.2.4 ..... 7-64
- Force(s)
  - exerted ..... 14.5.2 ..... 14-43 - 14-47
  - hand controls requiring high force
    - 7.4.4.24 ..... 7-94
  - isometric joysticks .... 7.4.4.20.1 ..... 7-92
  - maximum for controls
    - 14.5.2.1 ..... 14-43
  - push and pull
    - horizontal ..... 14.5.3.1 ..... 14-47
    - vertical ..... 14.5.3.2 ..... 14-48
  - push and pull controls
    - 7.4.4.14.7 ..... 7-87
  - push and pull operation
    - 7.2.9.1.3.d ..... 7-39
- Force limit(s)
  - of handles ..... 6.2.5.1.5 ..... 6-8
  - to access equipment ... 6.3.3.1.7 ..... 6-16
- Forecast readability formula
  - 10.2.3.2.1 ..... 10-7
- Foreign work force
  - maintenance by ..... 14.2.1 ..... 14-15
  - operation by ..... 14.2.1 ..... 14-15
- Forklifts, ramps for ..... 9.3.5 ..... 9-19
- Form(s) (*see also* Fields (in forms))
  - 8.4.3 ..... 8-92 - 8-97
  - completion ..... 8.4.3.7.6 ..... 8-97
  - consistency ..... 8.4.3.1.2 ..... 8-92
  - data entry ..... 8.4.3.7 ..... 8-96
  - default(s) (*see* Field(s) (in forms), defaults)
    - 8.4.3.6 ..... 8-96
  - editing ..... 8.4.3.7 ..... 8-96
  - error management ..... 8.4.3.8 ..... 8-97
  - field(s) ..... 8.4.3.2 ..... 8-92 - 8-93
  - field help ..... 8.4.3.1.3 ..... 8-92
- field labels ..... 8.4.3.3 ..... 8-93
- layout ..... 8.4.3.4 ..... 8-94
- correspondence between screen and document
    - 8.4.3.4.1 ..... 8-94
  - large forms ..... 8.4.3.4.3 ..... 8-95
  - ordering and grouping of fields
    - 8.4.3.4.2 ..... 8-95
- navigation ..... 8.4.3.5 ..... 8-95 - 8-96
- easy cursor movement
    - 8.4.3.5.2 ..... 8-95
  - initial cursor position
    - 8.4.3.5.1 ..... 8-95
  - no automatic cursor movement
    - 8.4.3.5.3 ..... 8-95
  - not to protected fields
    - 8.4.3.5.5 ..... 8-95
  - only to fields and control objects
    - 8.4.3.5.4 ..... 8-95
  - to "next" field ..... 8.4.3.5.6 ..... 8-95
  - to "previous" field
    - 8.4.3.5.6 ..... 8-95
  - with pointing device
    - 8.4.3.5.7 ..... 8-96
- title ..... 8.4.3.1.1 ..... 8-92
- Format(ing) (*see also* Layout)
  - a glossary ..... 10.4.10.2 ..... 10-44
  - an index ..... 10.4.11.2 ..... 10-44
  - convertible ..... 10.6.2 ..... 10-66
  - equations ..... 10.4.7.3 ..... 10-42
  - for messages, standard
    - 8.3.12.5.2 ..... 8-84
  - for transmitted messages
    - 8.1.3.1.3 ..... 8-6
  - forms (*see* Forms, layout)
  - formulas ..... 10.4.7.3 ..... 10-35
  - hyphenation ..... 8.4.2.3.4 ..... 8-91
  - incompatible, incoming message
    - 8.7.6.4.1 ..... 8-135
  - justification of text .... 8.4.2.3.4 ..... 8-91
  - line breaks ..... 8.4.2.3.2 ..... 8-91
  - lists ..... 10.4.6.2 ..... 10-41
  - menus ..... 8.1.11.2 ..... 8-21 - 8-22
  - of displayed data ..... 8.5.1.11 ..... 8-102
  - of labels in graphic data displays
    - 8.5.5.4.13 ..... 8-112
  - of scrolling menus .... 8.3.7.4.1 ..... 8-68
  - of this HFDG ..... 1.4 ..... 1-3
  - on-line help ..... 8.6.1.1.5 ..... 8-126
  - page breaks ..... 8.4.2.3.6 ..... 8-91
  - pages in displays ..... 8.4.2.3.2 ..... 8-91
  - query language ..... 8.1.14.1.11 ..... 8-32
  - 8.1.14.3.7 ..... 8-33
  - screen ..... 8.2.1.4 ..... 8-42 - 8-43
  - tables ..... 10.4.5.4 ..... 10-39
  - text ..... 8.4.2.3 ..... 8-90
  - user-defined ..... 8.4.2.3.1 ..... 8-90
  - user documentation ... 10.3 ..... 10-19 - 10-31
- Form-filling interaction method
  - 8.1.10 ..... 8-19
  - applicable criteria and guidelines
    - 8.1.10.4 ..... 8-19
  - appropriate use ..... 8.1.8.1.b ..... 8-16
  - consistency ..... 8.1.10.1 ..... 8-19
  - default entries ..... 8.1.10.2 ..... 8-19
- Formulas (in user documentation)
  - 10.4.7 ..... 10-41 - 10-42
  - format ..... 10.4.7.3 ..... 10-42

Formulas (in user documentation) (continued)  
 identification ..... 10.4.7.1 ..... 10-41  
 location ..... 10.4.7.2 ..... 10-42  
 fractions (in user documentation)  
 10.2.4.10.3 ..... 10-17  
 Freezing a display (*see* Data display, freezing)  
 Frequency range  
 auditory warning signals  
 7.3.2.2.6 ..... 7-44  
 headphones and loudspeakers  
 7.3.5.2.1 ..... 7-49  
 speech transmission equipment  
 7.3.5.1.1 ..... 7-48  
 telephone systems ..... 7.3.5.5.1 ..... 7-52  
 Friction in controls  
 to reduce tremor ... 14.5.2.5 ..... 14-46  
 Fuel lines ..... 6.9.2.2.4 ..... 6-68  
 Function allocation ..... 4.3.1 ..... 4-5  
 Function diagrams (in user documentation)  
 10.4.4.5.3 ..... 10-37  
 Function keys  
 assignment of functions by frequency of use  
 8.1.12.19 ..... 8-28  
 assignment of functions by importance  
 8.1.12.19 ..... 8-28  
 consistency ..... 8.1.12.2, 8.1.12.3 ..... 8-26  
 disabling of unused keys  
 8.1.12.7 ..... 8-27  
 feedback ..... 8.1.12.4 ..... 8-27  
 frequently-used functions  
 8.1.12.11 ..... 8-28  
 menu items selectable by function keys  
 8.1.12.18 ..... 8-28  
 multifunction keys 8.1.12.16 ..... 8-28  
 single-function keys  
 8.1.12.15 ..... 8-28  
 macros ..... 8.1.12.9 ..... 8-27  
 related functions on same key  
 8.1.12.13 ..... 8-28  
 related sets of functions  
 8.1.12.14 ..... 8-28  
 repeated key presses .. 8.1.12.12 ..... 8-28  
 return to base-level functions  
 8.1.12.8 ..... 8-27  
 safeguarding ..... 8.1.12.20 ..... 8-29  
 single function per key  
 8.1.12.1 ..... 8-26  
 single-key operation .. 8.1.12.10 ..... 8-27  
 single key press ..... 8.1.12.12 ..... 8-32  
 "soft" function keys  
 activation of ..... 8.1.12.6, 8.1.12.10 ..... 8-27  
 labeling ..... 8.1.12.16, 8.1.12.18 ... 8-28  
 screen representation . 8.1.12.5 ..... 8-27  
 status indication ..... 8.1.12.17 ..... 8-28  
 user-defined functions  
 8.1.12.9 ..... 8-27  
 Function keys, fixed ..... 8.8.2 ..... 8-140  
 availability ..... 8.8.2.2 ..... 8-140  
 grouping of ..... 8.8.2.4 ..... 8-140  
 keyboard equivalents . 8.8.1.7 ..... 8-139  
 location of ..... 8.8.2.4 ..... 8-140  
 mechanical overlays .. 8.8.2.2 ..... 8-140  
 nonactive keys ..... 8.8.2.3 ..... 8-140  
 standardization ..... 8.8.2.1 ..... 8-140  
 Function key interaction method (*see also* Function  
 keys ..... 8.1.12 ..... 8-26 - 8-29  
 appropriate use ..... 8.1.8.1.d ..... 8-18

consistency ..... 8.1.12.2, 8.1.12.3 ..... 8-26  
 Functional independence . 6.3.1.1 ..... 6-14  
 Functionality of equipment  
 6.3.2 ..... 6-15  
 6.3.2.1 ..... 6-15  
 6.3.2.3 ..... 6-15  
 Funnels built-in ..... 6.14.2.12 ..... 6-90  
 Fuse(s) ..... 6.13 ..... 6-83 - 6-89  
 anticorrosion precautions  
 6.13.2.8 ..... 6-85  
 as safeguards ..... 6.13.2.3 ..... 6-84  
 for individual units .... 6.13.1.4 ..... 6-84  
 grouping ..... 6.13.1.2 ..... 6-84  
 holders ..... 6.13.2.4 ..... 6-84  
 6.13.2.7 ..... 6-85  
 6.13.2.8 ..... 6-85  
 6.12.3.5 ..... 6-83  
 installation ..... 6.13.2 ..... 6-84  
 labeling ..... 6.13.5.1 ..... 6-88  
 location ..... 6.13.2.6 ..... 6-85  
 providing ..... 6.15.1.2.2 ..... 6-95  
 rating ..... 6.13.5.2 ..... 6-88  
 replacement ..... 6.13.2.5 ..... 6-85  
 sealed ..... 6.13.2.8 ..... 6-85  
 selection ..... 6.13.1.1 ..... 6-83  
 spare ..... 6.13.2.7 ..... 6-85

**G**

Ganged control knobs (*see* Knobs, ganged)  
 Gaskets (*see* Seals)  
 Gas line connectors ..... 6.8.6 ..... 6-54  
 Gender-neutral language . 10.2.3.1.3 ..... 10-8  
 General design guidance . 6.1.1.1 ..... 6-2  
 General design requirements  
 4 ..... 4-1  
 Glare  
 avoid creating ..... 13.4.2.3 ..... 13-8  
 control ..... 7.2.4.4 ..... 7-25  
 counters in visual displays  
 7.2.9.1.6 ..... 7-39  
 elimination of ..... 13.4.1.3 ..... 13-8  
 from light sources ..... 13.4.4 ..... 13-11  
 reflected ..... 13.4.5 ..... 13-12  
 Glossary (in user documentation)  
 10.2.4.7.4 ..... 10-14  
 10.2.4.8.4 ..... 10-16  
 10.4.10 ..... 10-44  
 format ..... 10.4.10.2 ..... 10-44  
 in index ..... 10.2.4.7.4 ..... 10-14  
 location ..... 10.4.10.3 ..... 10-44  
 terms ..... 10.4.10.1 ..... 10-44  
 Gloves  
 accommodating for ... 6.5.1.5 ..... 6-29  
 acid resistant ..... 12.9.2 ..... 12-19  
 control compatibility .. 7.4.1.5.1 ..... 7-61  
 "Go-back"  
 error correction ..... 8.1.5.1.11 ..... 8-11  
 user interrupt ..... 8.1.4.3 ..... 8-9  
 Go, no-go test equipment  
 6.15.3 ..... 6-98  
 advantages ..... 6.15.3 ..... 6-98  
 disadvantages ..... 6.15.3 ..... 6-98  
 Graphic(s)  
 cursor ..... 8.4.6.1.2 - 8.4.6.1.3 .... 8-99  
 entry and editing ..... 8.4.6.2 ..... 8-99 - 8-100  
 in displays ..... 8.4.6 ..... 8-99 - 8-101

- Graphic(s) (continued)
  - in map displays ..... 8.5.8.4 ..... 8-122
  - pointing device ..... 8.4.6.1.1 ..... 8-99
  - user aids ..... 8.4.6.3 ..... 8-101
- Graphical interface
  - auditory representation
    - 8.9.6.2.1 ..... 8-155
- Graphical representations
  - status displays ..... 5.7.5 ..... 5-20
  - diagnostic and status .. 5.7.9 ..... 5-21
  - human interfaces ..... 5.6.4 ..... 5-19
  - iconic representation . 5.7.9 ..... 5-21
- Graphic data display ..... 8.5.5 ..... 8-107 - 8-115
  - appropriate format .... 8.5.5.1.3 ..... 8-108
  - areas ..... 8.5.5.7 ..... 8-113
  - breaks in axes ..... 8.5.5.4.5 ..... 8-111
  - color and pattern coding
    - 8.5.5.4.3 ..... 8-110
  - complex formats ..... 8.5.5.1.1 ..... 8-108
  - computer models ..... 8.5.5.3.16 ..... 8-110
  - consistency ..... 8.5.5.1.7 ..... 8-108
  - consistent formats ..... 8.5.5.4.7 ..... 8-111
  - creating and editing ... 8.5.5.3 ..... 8-108 - 8-110
    - automated completion of polygons
      - 8.5.5.3.6 ..... 8-109
    - automated production of scales
      - 8.5.5.3.4 ..... 8-109
    - computer aids ..... 8.5.5.3.1 ..... 8-109
    - computer aids for drawing figures
      - 8.5.5.3.11 ..... 8-109
    - filling enclosed areas
      - 8.5.5.3.15 ..... 8-110
    - grid references ..... 8.5.5.3.9 ..... 8-109
    - grouping elements ..... 8.5.5.3.14 ..... 8-110
    - joining lines ..... 8.5.5.3.7 ..... 8-109
    - line drawing ..... 8.5.5.3.5 ..... 8-109
    - line segments ..... 8.5.5.3.8 ..... 8-109
    - operations ..... 8.5.5.3.13 ..... 8-109
    - plotting aids ..... 8.5.5.3.2 ..... 8-109
    - plotting stored data
      - 8.5.5.3.3 ..... 8-109
    - scale changes ..... 8.5.5.3.12 ..... 8-109
    - user-specified rules
      - 8.5.5.3.10 ..... 8-109
    - validation ..... 8.5.5.3.1 ..... 8-109
  - diagrams ..... 8.5.5.11 ..... 8-114
  - displaying values with plotted data
    - 8.5.5.2.2 ..... 8-108
  - display value of a data point
    - 8.5.5.1.6 ..... 8-108
  - duplicate axes ..... 8.5.5.4.6 ..... 8-111
  - flowcharts ..... 8.5.5.12 ..... 8-114
  - general ..... 8.5.5.1 ..... 8-108
  - grid lines ..... 8.5.5.5 ..... 8-112
  - identifying critical data
    - 8.5.5.2 ..... 8-108
  - label(s) ..... 8.5.5.1.8 ..... 8-108
  - label format ..... 8.5.5.4.13 ..... 8-112
  - labeling axes ..... 8.5.5.4.10 ..... 8-111
  - labeling graphic elements
    - 8.5.5.2.3 ..... 8-108
  - linear scales ..... 8.5.5.4.8 ..... 8-111
  - lines and curves ..... 8.5.5.6 ..... 8-113
  - needed data only ..... 8.5.5.1.4 ..... 8-108
  - numeric scales ..... 8.5.5.4.12 ..... 8-112
  - one axis per scale ..... 8.5.5.4.9 ..... 8-111
  - patterns ..... 8.5.5.4.4 ..... 8-111
  - pictures ..... 8.5.5.10 ..... 8-114
  - pie charts ..... 8.5.5.9 ..... 8-114
  - scale divisions ..... 8.5.5.4.10 ..... 8-111
  - 8.5.5.4.11 ..... 8-112
  - scales, labels, and coding
    - 8.5.5.3 ..... 8-108 - 8-110
  - scatterplots ..... 8.5.5.8 ..... 8-113
  - size ..... 8.5.5.1.2 ..... 8-108
  - supplementary text .... 8.5.5.2.4 ..... 8-108
  - symbols, consistent use
    - 8.5.5.4.2 ..... 8-110
  - user-selected style ..... 8.5.5.1.5 ..... 8-108
- Graphic data entry ..... 8.4.6 ..... 8-99 - 8-101
  - entry and editing ..... 8.4.6.2 ..... 8-99 - 8-100
    - alignment grid ..... 8.4.6.2.3 ..... 8-100
    - alternate drawing methods
      - 8.4.6.2.3 ..... 8-100
    - attribute display ... 8.4.6.2.6 ..... 8-100
    - attribute selection . 8.4.6.2.8 ..... 8-100
    - automatic closure .. 8.4.6.2.5 ..... 8-100
    - colors and patterns
      - 8.4.6.2.7 ..... 8-100
    - consistency lines ... 8.4.6.2.2 ..... 8-99
    - copy, rotate, reverse
      - 8.4.6.2.9 ..... 8-100
    - drawing lines ..... 8.4.6.2.1 ..... 8-99
    - enlarge, reduce, zoom
      - 8.4.6.2.11 ..... 8-100
      - 8.4.6.2.12 ..... 8-100
    - grouping objects ... 8.4.6.2.14 ..... 8-100
    - reposition, duplicate, delete
      - 8.4.6.2.10 ..... 8-100
  - naming ..... 8.4.6.1.5 ..... 8-99
  - overlapping object display
    - 8.4.6.2.14 ..... 8-100
  - retrieving ..... 8.4.6.1.5 ..... 8-99
  - saving ..... 8.4.6.1.5 ..... 8-99
  - validation on input .... 8.4.6.1.4 ..... 8-99
- Graphic information
  - textual description of . 10.6.3.d ..... 10-67
- Graphics cursor (*see* Cursor, graphics)
- Graphic symbols
  - for circuit elements ... 10.2.4.13.1 ..... 10-18
  - for electrical elements
    - 10.2.4.13.1 ..... 10-18
  - for electronic elements
    - 10.2.4.13.1 ..... 10-18
  - for logic diagrams ..... 10.2.4.13.3 ..... 10-18
  - for mechanical parts ... 10.2.4.13.2 ..... 10-18
- Grasp areas ..... 6.2.6 ..... 6-11
  - for covers ..... 6.5.1.4 ..... 6-29
- Gray, in controls ..... 7.4.1.4.5 ..... 7-61
- Greater-than symbol as field label
  - 8.4.3.2.6 ..... 8-93
- Green
  - coding in CRT displays
    - 7.2.4.2.3 ..... 7-23
  - dot matrix emitters .... 7.2.6.5 ..... 7-32
  - for comparisons ..... 8.2.4.1.23 ..... 8-53
  - in controls ..... 7.4.1.4.5 ..... 7-61
  - in displays ..... 8.2.4.1.21 ..... 8-53
  - in scales ..... 7.2.3.1.16 ..... 7-20
  - reserved meaning in displays
    - 8.5.4.5.1.d ..... 8-106
  - use in CRT displays ... 7.2.4.2.4.d ..... 7-24

Grid  
 alignment ..... 8.4.6.2.3 ..... 8-100  
 lines ..... 8.5.5.5 ..... 8-112  
     noninterference with data  
         8.5.5.5.2 ..... 8-112  
     user option ..... 8.5.5.5.3 ..... 8-112  
     when to use ..... 8.5.5.5.1 ..... 8-112  
 overlay in map displays  
     8.5.8.3.20 ..... 8-122  
 references in graphic data displays  
     8.5.5.3.9 ..... 8-109  
 user-specified intervals  
     8.4.6.2.3 ..... 8-100  
 Grid and stylus devices ... 7.4.4.23 ..... 7-94  
     dynamic characteristics  
         7.4.4.23.2 ..... 7-94  
     specifications ..... 7.4.4.23.1 ..... 7-94  
     when to use ..... 7.4.4.23.3 ..... 7-95  
 Grommets  
     use of ..... 6.9.1.1.14 ..... 6-58  
 Ground(ing) ..... 12.4.4 ..... 12-11  
     common ..... 12.4.4.1 ..... 12-11  
     connection ..... 12.4.4.4  
         - 12.4.4.6 ..... 12-11  
     marking ..... 12.4.4.6 ..... 12-11  
     path ..... 12.4.4.2 ..... 12-11  
     point ..... 6.14.5.5 ..... 6-92  
     strap ..... 12.4.4.6 ..... 12-11  
     techniques ..... 12.4.4.3 ..... 12-11  
     terminating ..... 12.4.4.10 ..... 12-12  
     wire in cable ..... 12.4.4.10 ..... 12-12  
 Grouping  
     control-display association  
         7.4.1.4.6 ..... 7-61  
     data items in displays ..... 8.2.1.1.2 ..... 8-40  
     elements in graphic data displays  
         8.5.5.3.14 ..... 8-110  
     indicator lights ..... 7.2.2.1.5 ..... 7-14  
     of displays and controls, (*see* Display-control  
         grouping)  
     options in menus ..... 8.1.11.2.3 ..... 8-21  
         8.4.1.5.3 ..... 8-88  
         8.3.7.3.3 ..... 8-67  
 Guard(s) ..... 6.5 ..... 6-28 - 6-34  
     12.5.2 ..... 12-15  
     design ..... 12.5.2.5 ..... 12-16  
     different forms of ..... 6.5 ..... 6-28  
     for internal controls ... 7.4.1.6.2  
         - 7.4.1.6.4 ..... 7-62  
     mounting ..... 12.5.2.5 ..... 12-16  
     on drawers ..... 6.3.3.1.8 ..... 6-16  
     on equipment ..... 12.5.2.1 ..... 12-15  
         12.5.2.5 ..... 12-16  
         height ..... 12.2.2.3 ..... 12-3  
     on racks ..... 6.3.3.1.8 ..... 6-16  
 Guarding ..... 12.5.2.5 ..... 12-16  
     electrical parts - live .. 12.2.1.4 ..... 12-1  
     floor and wall openings  
         12.2.1.4 ..... 12-1  
     power transmissions .. 12.2.1.4 ..... 12-1  
 Guard rails ..... 9.3.3.4 ..... 9-11  
     9.3.3.4.2 ..... 9-12  
     12.2.2.3 ..... 12-3  
     dimensions ..... 9.3.3.4.2 ..... 9-12  
     for catwalks ..... 9.3.2.3 ..... 9-10  
     for platforms ..... 9.3.3.1.2 ..... 9-11  
         9.3.4.1 ..... 9-13

providing ..... 9.3.3.4.5 ..... 9-12  
     12.2.2.3 ..... 12-3  
 Guard screen use ..... 9.3.3.4.3 ..... 9-12  
     12.2.2.4 ..... 12-4  
 Guidance  
     log on errors ..... 8.2.2.2.4 ..... 8-47  
     stacked command correction  
         8.1.5.3.6 ..... 8-13  
 Guides  
     for test probes ..... 6.14.4.2 ..... 6-91  
     on parts ..... 6.2.8.1  
         - 6.2.8.2 ..... 6-12  
     quick reference ..... 10 ..... 10-1  
     user ..... 10 ..... 10-1  
 Guidelines  
     alternative to ..... 1.4.1.1 ..... 1-3  
     design ..... 1.4.1.1 ..... 1-3  
 Gunning fog index ..... 10.2.3.2.1 ..... 10-7

**H**

Hand controls requiring high force  
     7.4.4.24 ..... 7-94  
     specifications ..... 7.4.4.24.1 ..... 7-94  
     when not to use ..... 7.4.4.24.2 ..... 7-96  
 Hand grips, folding ..... 12.2.2.9 ..... 12-4  
 Hand-operated controls (*see* Ball controls, Cranks, .....  
     Grid and stylus devices, High-force hand controls,  
     Joysticks, Key-operated switches, Keyboards,  
     Knobs, Legend switches, Levers, Miniature  
     controls, ON-OFF switches, Printed circuit  
     switches, Push buttons (controls), Push-pull  
     controls, Rocker switches, Rotary selector  
     switches, Slide switches, Thumbwheels,  
     Toggle switches)  
 Handhold ..... 9.3.3.4 ..... 9-11  
     fixed ..... 12.2.2.10 ..... 12-4  
     folding ..... 12.2.2.9 ..... 12-4  
     providing ..... 9.3.3.4.4, 9.3.4.4.5 ..... 9-12  
         12.2.2.8 ..... 12-4  
     telescope ..... 12.2.2.9 ..... 12-4  
 Handle(s) ..... 6.2.5 ..... 6-8  
     as stands ..... 6.2.7.3 ..... 6-12  
     attachment ..... 6.2.5.2.4 ..... 6-9  
     characteristics ..... 6.2.5.2 ..... 6-9  
     comfort ..... 6.2.5.2.1 ..... 6-9  
     conductivity ..... 6.2.5.2.3 ..... 6-9  
     crank ..... 7.4.4.7.3 - 7.4.4.7.5 ..... 7-75  
     diameter ..... 6.2.5.3.2 ..... 6-11  
     dimensions ..... 6.2.5.3 ..... 6-9  
     folded ..... 6.2.5.2.5 ..... 6-9  
     force, opening hatches  
         9.3.4.5.4 ..... 9-17  
     for covers ..... 6.5.1.4 ..... 6-29  
     hinged ..... 6.2.5.2.5 ..... 6-9  
     insulated ..... 6.16.2.3, 6.16.3.5 ..... 6-101  
     location ..... 6.2.5.4 ..... 6-11  
     pairs ..... 6.2.5.4.2 ..... 6-11  
     recessed ..... 6.2.5.2.5 ..... 6-9  
     single ..... 6.2.5.4.1 ..... 6-11  
     surface ..... 6.2.5.2.2 ..... 6-9  
     tool ..... 6.16.2.1 ..... 6-101  
     when needed ..... 6.2.5.1 ..... 6-8  
 Handling  
     design for ..... 6.2 ..... 6-5 - 6-13  
         6.3 ..... 6-13

Handling (continued)			
electrolytes .....	12.9.1 .....	12-18	
equipment	12.9.2 .....	12-19	
design compatibility			
4.2.1.c .....		4-3	
designing .....	6.2 .....	6-5 - 6-13	
one person .....	6.3.1.5 .....	6-14	
one-person .....	6.3.1.5 .....	6-14	
Handrails			
around platforms .....	12.2.2.3 .....	12-3	
on fixed ladders .....	9.3.5.6.4 .....	9-28	
on ramps .....	9.3.5.2.5 .....	9-21	
on stairs .....	9.3.5.3.4 .....	9-22	
on stairs .....	9.3.5.2.5 .....	9-21	
on stairs .....	E9.3.5.4.1 .....	9-24	
Handsets, telephone	7.3.5.5.1 .....	7-52	
accessibility .....	7.3.5.3.3 .....	7-50	
cradles .....	7.3.5.5.3 .....	7-52	
"Handshaking" .....	11.3.1.11 .....	11-7	
Hard copy documents			
data entry field organization			
8.3.12.2.2 .....		8-81	
form layout correspondence			
8.4.3.4.1 .....		8-94	
Hardware standardization			
4.1.2 .....		4-1	
Harness ( <i>see</i> Wire harness)			
Hatch(es) .....	9.3.4.5 .....	9-17	
access, whole body ...	9.3.4.6.1 .....	9-18	
clearance dimensions .	9.3.4.5.5 .....	9-17	
escape .....	9.3.4.6.2 .....	9-18	
flush with surfaces ....	9.3.4.5.2 .....	9-17	
handle force .....	9.3.4.5.4 .....	9-17	
opening .....	9.3.4.5.3 .....	9-17	
rectangular .....	9.3.4.5.8 .....	9-17	
rescue through .....	9.3.4.5.7 .....	9-17	
use for maintenance ...	9.3.4.5.1 .....	9-17	
Hazard(s) ( <i>see also</i> Labels, hazard)			
biological .....	4.2.3 .....	4-3	
chemical .....	6.1.2.6 .....	6-3	
chemical .....	4.2.3 .....	4-3	
chemical .....	6.1.2.6 .....	6-3	
electrical .....	6.2.5.4.3 .....	6-11	
electrical .....	6.4.5.3 .....	6-27	
electrical .....	12.4 .....	12-5 - 12-13	
explosion .....	12.13 .....	12-23	
fire .....	12.11 .....	12-20 - 12-21	
gas .....	12.6 .....	12-16	
implosion .....	12.13 .....	12-23	
liquid .....	12.6 .....	12-16	
physical .....	12.5 .....	12-13 - 12-16	
radiation .....	12.8 .....	12-18	
temperature .....	12.10 .....	12-19 - 12-20	
thermal .....	6.2.5.4.3 .....	6-11	
toxic .....	12.7 .....	12-16 - 12-18	
toxic chemical hazards			
12.7.5 .....		12-18	
workplace .....	12.12 .....	12-21 - 12-23	
Hazard-alerting device			
location .....	12.2.1.2 .....	12-1	
providing .....	12.2.1.1 .....	12-1	
redundancy .....	12.2.1.3 .....	12-1	
Hazardous condition .....	6.1.2.6 .....	6-3	
Hazardous gases .....	12.6 .....	12-16	
Hazardous liquids .....	12.6 .....	12-16	
Hazardous location .....	6.1.2.6 .....	6-3	
Hazardous materials .....	12.11.3 .....	12-20	
12.11.6 .....		12-21	
Headers			
in message handling windows			
8.3.12.5.2 .....		8-84	
in this HFDG .....	1.4.2.3 .....	1-4	
in this HFDG .....	E1.4.2.4 .....	1-5	
Headers (in user documentation)			
10.3.2.2 .....		10-21 - 10-22	
location information ..	10.3.2.2.1 .....	10-21	
location of information elements			
10.3.2.2.3 .....		10-21	
10.3.2.2.4 .....		10-22	
margins .....	10.3.2.2.2 .....	10-22	
use of .....	10.2.1.1 .....	10-4	
Headings .....	10.2.1.1.3 .....	10-4	
hierarchy .....	10.2.1.1.3 .....	10-4	
in this HFDG .....	1.4.2.2 .....	1-4	
in user documentation			
10.2.1.1 .....		10-4	
levels of .....	10.1.2.2 .....	10-3	
typographic cues .....	10.1.2.3 .....	10-3	
uniqueness of .....	10.2.1.1.3 .....	10-4	
uniqueness of .....	10.2.1.1.4 .....	10-5	
Hazard warnings .....	7.6.5.2 .....	7-114	
add color code and symbols			
7.6.5.2 .....		7-114	
audible frequencies ...	7.6.5.2 .....	7-114	
glare .....	7.6.5.2 .....	7-114	
redundant visual and auditory			
7.6.5.2 .....		7-114	
vibrating option .....	7.6.5.5 .....	7-114	
Headphone jack .....	8.9.6.1.2.d .....	8-155	
Headphones ( <i>see</i> Headsets)			
Headsets ( <i>see also</i> Speech reception equipment)			
binaural ( <i>see also</i> Dichotic presentation)			
7.3.2.3.5 .....		7-45	
7.3.2.3.7 .....		7-45	
7.3.2.3.14 .....		7-46	
7.3.5.2.5 .....		7-50	
7.3.5.2.6 .....		7-50	
comfort .....	7.3.5.3.1 .....	7-50	
frequency range .....	7.3.5.2.1 .....	7-49	
hands-free operation ..	7.3.5.3.2 .....	7-50	
in phase with loudspeaker			
7.3.5.4.7 .....		7-51	
minimum volume setting			
7.3.5.4.1 .....		7-51	
side tone .....	7.3.5.4.7 .....	7-51	
volume controls .....	7.3.5.4.1 .....	7-51	
Health hazards, protection from			
4.2.3.b .....		4-3	
Hearing auditory outputs (ADA)			
7.6.2.1 .....		7-105	
added cues - visual, tactile			
7.6.2.3 .....		7-106	
controls .....	7.6.2.1 .....	7-105	
hearing aids .....	7.6.2.1 .....	7-105	
nonmeaningful sound, reduce repetition			
7.6.2.1 .....		7-105	
radio and CD players, exceptions			
7.6.2.3 .....		7-106	
Hearing conservation program			
12.12.8 .....		12-22	
13.5.2.10 .....		13-17	
administering .....	13.5.1.2 .....	13-14	
placement in .....	13.5.1.4, 13.5.1.6 .....	13-15	
Hearing protection .....	13.5.1.4, 13.5.1.6 .....	13-15	

Heavy equipment .....	6.3.3.1.2 .....	6-16	units of text .....	8.4.2.2.7 .....	8-90
	6.3.4 .....	6-17		8.3.8.7 .....	8-69
Height ( <i>see also</i> Character height)			High-pressure		
working .....	6.3.4.1.7 .....	6-18	lines		
Help ( <i>see also</i> On-line help, User guidance)			provisions .....	6.9.2.1.9 .....	6-67
availability .....	8.3.12.1.1 .....	8-80	routing .....	6.9.2.2.3 .....	6-68
application menu bar			units		
8.3.12.1.1.b .....	8-80		screws for .....	6.7.3.2.5 .....	6-42
keyboard .....	8.3.12.1.1.e .....	8-80	High-temperature		
message area .....	8.3.12.1.1.d .....	8-80	equipment .....	12.5.2.4 .....	12-16
push button .....	8.3.12.1.1.d .....	8-80	High voltage ( <i>see also</i> Medium voltage)		
system menu bar ...	8.3.12.1.1.a .....	8-80	areas		
data entry fields .....	8.3.12.2.6 .....	8-82	enclosed .....	12.5.2.2 .....	12-15
fields in message handling windows			insulated .....	6.15.1.2.7 .....	6-95
8.3.12.5.3 .....	8-84		shielded .....	6.15.1.2.7 .....	6-95
windows ( <i>see</i> Windows, help)			guarding .....	12.4.1.13 .....	12-8
"Help"			lines, routing of .....	6.9.1.3.10 .....	6-61
always accessible .....	8.3.9.3.4 .....	8-71	Hinges		
command .....	8.6.1.2.7 .....	8-127	ground connections ...	12.4.4.7 .....	12-12
help on "Help" .....	8.6.1.5.4 .....	8-129	mounting on .....	6.3.3 .....	6-15
notification of unavailability			not for grounding path		
8.6.1.2.2 .....	8-127			12.4.4.8 .....	12-12
operation .....	8.4.3.1.3 .....	8-92	Hinged doors, for access		
option in menu bar ....	8.3.10.1.3 .....	8-73		6.5 .....	6-28
option in system menu bar			Holes		
8.3.9.3.2, 8.3.9.3.4 ....	8-71		for fasteners .....	6.5.8.9 .....	6-32
push button .....	8.3.10.1.6 .....	8-73		6.6.4.9 .....	6-36
in confirmation message window				6.7.1.7 .....	6-39
8.3.10.2.10 .....	8-76		labels for part orientation		
in error message window			6.2.8.6 .....	6-12	
8.3.10.2.7 .....	8-76		6.4.6.4 .....	6-27	
in information message window			6.10.5.18 .....	6-79	
8.3.10.2.8 .....	8-76		open .....	9.3.4.6.3 .....	9-19
in request message window			Hood		
8.3.10.2.6 .....	8-75		for CRT displays .....	7.2.4.3.2 .....	7-24
in warning message window			glare control .....	7.2.4.4.1 .....	7-25
8.3.10.2.11 .....	8-76		Hooks, location of .....	12.5.1.8 .....	12-15
in "working" message window			Horizontal spacing (in user documentation)		
8.3.10.2.13 .....	8-76		10.3.2.3.2 .....	10-22	
reminder of availability			"Hotspot" (of a pointer) ...	8.8.3.6.2, 8.8.3.6.3 ...	8-144
8.6.1.2.2 .....	8-127		Human activities .....	9.1.1 .....	9-1
Helvetica font .....	10.3.3.5 .....	10-28	Human-centered automation		
Hierarchical menus ( <i>see</i> Menus, hierarchical)			definition .....	5.2 .....	5-4
High current switching devices, shielded			integrate automation with human subsystem		
6.10.3.3.7 .....	6-76		5.2 .....	5-4	
Highlighting			role of automation .....	5.2.1 .....	5-4
diagrams, portions of			directable .....	5.2.1 .....	5-4
8.5.5.11.2 .....	8-114		feedback .....	5.2.1 .....	5-4
in displays .....	8.2.4.1.25 .....	8-53	not autonomous or silent		
in help windows .....	8.3.12.1.5 .....	8-81	5.2.1 .....	5-4	
in user-computer interaction			not subversive .....	5.2.2 .....	5-4
8.2.1.3.2 .....	8-41		subservient .....	5.2.1 .....	5-4
flowcharts, paths or portions			Human-computer interfaces		
8.5.5.12.3 .....	8-115		8 .....	8-1 - 8-157	
lines and curves in displays			human interfaces .....	5.6 .....	5-18
8.5.5.6.2 .....	8-113		"media" .....	5.6 .....	5-18
most frequent menu option			"message" .....	5.6 .....	5-18
8.4.1.1.3 .....	8-86		power users .....	5.1.2.9 .....	5-4
on-line help .....	8.6.1.1.7 .....	8-126	Human error(s) (See also error in human-computer		
points in scatterplots ..	8.5.5.8.2 .....	8-113	interface(s))		
segments in pie charts			data .....	5.3.4 .....	5-11
8.5.5.9.4 .....	8-114		degraded modes .....	5.3.4 .....	5-11
selected exclusive button			error resistant .....	5.2.17 .....	5-8
8.1.15.3.3 .....	8-38		error tolerant .....	5.2.17 .....	5-8
selected option in pop-up menu			in automated systems .	5.2.17 .....	5-8
8.4.1.4.2 .....	8-87		mode errors .....	5.3.5 .....	5-12

- Human error(s) (continued)  
 multifunction dynamic modes  
   5.3.5 ..... 5-12  
 reliability, risk ..... 5.7.7 ..... 5-21  
 risk ..... 5.3.4 ..... 5-11
- Human-equipment interfaces  
 7 ..... 7-1 - 7-115
- Human Factors and Ergonomics Society  
 9.6 ..... 9-52
- Human Factors Design Guide use  
 foreword ..... i  
 not a substitute ..... foreword ..... i
- Human factors information  
 foreword ..... i
- Human interaction ..... 4.3.4 ..... 4-5
- Human interfaces  
 C<sup>3</sup> models ..... 5.4.3 ..... 5-14  
 cognitive models ..... 5.6.2 ..... 5-18  
 definition ..... 5.4.3 ..... 5-14  
 disciplinary approaches  
   5.6.2 ..... 5-18  
 in complex systems .... 5.6 ..... 5-18  
 logical and explicit structure  
   5.1.2 ..... 5-2  
 maintenance automation  
   5.1.1 ..... 5-2  
 operational focus in data space  
   5.1.2 ..... 5-2  
 prototyping ..... 5.5.3 ..... 5-17  
 simplicity ..... 5.1.3 ..... 5-2  
 system engineering .... 5.5.1 ..... 5-17
- Human performance (*see* Performance, human)
- Human physical characteristics  
 4.3.5 ..... 4-5  
 applying ..... 14.1.5.3 ..... 14-14  
 cannot design ..... 14 ..... 14-1  
 cannot generate across  
   14.1.3.2 ..... 14-8  
 constructing ..... 14.1.4.2 ..... 14-9  
 dynamic ..... 14.3.3 ..... 14-30 - 14-36  
 guessing about ..... 14.1.1.1 ..... 14-2  
 integrating ..... 14.1.4.6 ..... 14-10  
 multiple ..... 14.1.5.3 ..... 14-14  
 selecting ..... 14.1.2.1 ..... 14-3  
 solving design problems with  
   14.3.1.1 ..... 14-16  
 static ..... 14.3.2 ..... 14-16 - 14-30  
 summing ..... 14.1.3.3 ..... 14-8  
 using ..... 14.3.1.2 ..... 14-16
- Human responsibilities  
 correcting failures ..... 5.2.2 ..... 5-4  
 involved and informed  
   5.2.3 ..... 5-4  
 monitoring automation  
   5.2.7 ..... 5-6  
 stated explicitly ..... 5.2.2 ..... 5-4  
 through meaningful tasks  
   5.2.4 ..... 5-5  
   by exception ..... 5.2.4 ..... 5-5  
   confirming intentions  
     5.2.4 ..... 5-5  
   human intentions, entering  
     5.2.4 ..... 5-5  
   proactive cross checking  
     5.2.4 ..... 5-5
- Human roles
- C<sup>3</sup> ..... 5.4.2 ..... 5-14  
 costs ..... 5.2.10 ..... 5-6  
 functions, tasks, changes  
   5.4.2 ..... 5-14  
 meaningful tasks ..... 5.2.4 ..... 5-5  
 purposeful tasks ..... 5.1.6 ..... 5-3  
 workload ..... 5.1.6 ..... 5-3
- Human strength (*see* Strength, human)
- Human tasks, considering  
 11.2.1 ..... 11-3
- Humidity ..... 13.3 ..... 13-3 - 13-7  
 exposure to ..... 13.3.1 ..... 13-5  
 levels ..... 13.3.12 ..... 13-7  
 measurements ..... 13.3.13 ..... 13-7  
 relative ..... 13.3.6 ..... 13-6  
 minimum ..... 13.3.10 ..... 13-7  
   13.3.11 ..... 13-7  
 verification of ..... 13.3.12 ..... 13-7
- Hyphenation ..... 8.4.2.3.5 ..... 8-91  
 10.2.3.10.4 ..... 10-9
- ## I
- I-beam, text cursor in insert mode  
 8.4.2.4.1 ..... 8-91  
 8.3.8.1 ..... 8-68
- Icons (*see also* Window states, iconized)  
 8.1.15.1 ..... 8-36 - 8-37  
 appropriate use ..... 8.1.8.1.h ..... 8-18  
 consistency ..... 8.1.15.1.4 ..... 8-36  
 description ..... 8.1.15.1.2 ..... 8-36  
 design ..... 8.1.15.1.6 ..... 8-36  
 interaction method .... 8.1.15.1 ..... 8-36 - 8-37  
 label ..... 8.1.15.1.3 ..... 8-36  
   8.1.15.1.2 ..... 8-36  
 location ..... 8.1.15.1.11 ..... 8-37  
   user preferences .... 8.1.15.1.12 ..... 8-37  
 manipulation of ..... 8.1.15.1.7 ..... 8-37  
 menu ..... 8.1.15.1.8, 8.1.15.1.9 ..... 8-37  
 moving ..... 8.1.15.1.12 ..... 8-37  
 opening an icon using a pointing device  
   8.3.5.11 ..... 8-63  
 opening an icon using the keyboard  
   8.3.5.12 ..... 8-63  
 resolution ..... 8.1.15.1.1 ..... 8-36  
 restoring window ..... 8.1.15.1.10 ..... 8-37  
 use of pointing device  
   8.1.15.1.7 ..... 8-37  
   8.1.15.1.5 ..... 8-36
- Icons, action  
 bound to window ..... 8.3.10.1.8 ..... 8-74  
 location and arrangement  
   8.3.10.1.7 ..... 8-73  
 number of ..... 8.3.10.1.7 ..... 8-73
- "Iconize"  
 control, secondary windows  
   8.3.2.1.2 ..... 8-56
- "Iconize"  
 control, title bar ..... 8.3.2.2.1 ..... 8-56  
 disallowed for message windows  
   8.3.10.2.2 ..... 8-74  
 iconizing a window using a pointing device  
   8.3.5.9 ..... 8-63  
 iconizing a window using the keyboard  
   8.3.5.10 ..... 8-63  
 in window menu .8.1.15.1.8 ..... 8-37



- "Iconize" (continued)  
 operation ..... 8.3.5.8 ..... 8-63  
 secondary window .... 8.3.2.1.3.d ..... 8-56  
 unavailable in icon menu  
     8.1.15.1.8 ..... 8-37
- Iconized window (*see* Window states, iconized)
- Identification ..... 11.3 ..... 11-4 - 11-9  
 equipment  
   interchangeable .... 6.3.2.2 ..... 6-15  
   noninterchangeable  
     6.3.2.4 ..... 6-15  
     8.2.2.2.2 ..... 8-47  
 in log on ..... 11.3.1.8, 11.3.1.9 ..... 11-5  
 inputting, information . 6.4.6.2 ..... 6-27  
 of accessible components  
   of access openings  
     in maintenance instructions  
       6.4.6.1 ..... 6-27  
     of circuit breakers ..... 6.12.3.5 ..... 6-83  
     of fuses ..... 6.12.3.5 ..... 6-83  
     of hand grasp areas .... 12.16.18 ..... 12-32  
 of maintenance tasks ..... 6.4.6.2 ..... 6-27  
 of pins in connector ... 6.8.8.3 ..... 6-56  
 of receptacles ..... 6.10.5.10, 6.10.5.11 ... 6-79  
 of terminals ..... 6.8.8.4 ..... 6-56  
     6.9.1.8.3 ..... 6-65  
     6.10.5.8, 6.10.5.9 ..... 6-79  
 tasks ..... 11.3.1.2 ..... 11-5  
 technologies ..... 11.3.3 ..... 11-8  
 through "Hand shaking"  
     11.3.1.11 ..... 11-7
- i.e., use of in user documentation  
     10.2.4.8.8 ..... 10-16
- If, use of in user documentation  
     10.2.4.5.1 ..... 10-13
- ility, ineffective human factors  
     5.5 ..... 5-17
- Illumination ..... 13.1.a ..... 13-1  
     13.4 ..... 13-7 - 13-14  
 adjustable  
   for visual displays, labels, controls  
     7.1.1.6 ..... 7-2  
 considerations ..... 13.4 ..... 13-7  
 dim  
   labels under ..... 6.3.5.3.2 ..... 6-21  
 for ladders ..... 9.3.5.2.6 ..... 9-21  
 for ramps ..... 9.3.5.2.6 ..... 9-21  
 for stairs ..... 9.3.5.2.6 ..... 9-21  
 for tasks ..... 13.4.2 ..... 13-8  
 levels  
   for dark adaptation  
     13.4.3 ..... 13-10  
   for work spaces .... 12.2.1.8 ..... 12-3  
 normal  
   labels under ..... 6.3.5.3.2 ..... 6-21  
 requirements ..... 13.4.2.2 ..... 13-8  
 system ..... 13.4.7.1 ..... 13-13  
 to eliminate glare ..... 13.4.1.3 ..... 13-8  
 workplace ..... 13.4.2.2 ..... 13-8
- Illustrations in proceduralized instructions  
     10.4.8.2 ..... 10-42
- Impact forces, environmental  
     4.2.2.b ..... 4-3
- Impairment ..... 7.6 ..... 7-102  
     8.9 ..... 8-149
- Imperative sentences ..... 10.2.3.7.1 ..... 10-10
- Inactive window (*see* Window states, inactive)
- Inch-pound units of measurement  
     10.2.4.11.1 ..... 10-17
- Inclinators ..... 9.3.3 ..... 9-10  
   safety features ..... 9.3.3.5.1 ..... 9-12  
     9.3.3.5.2 ..... 9-13
- Indentation  
   horizontal spacing ..... 10.3.2.3.2 ..... 10-22  
   paragraph ..... 10.3.2.4.1 ..... 10-23
- Index  
 in this HFDG ..... 1.4.2.5 ..... 1-5  
 in user documentation  
   content ..... 10.4.11 ..... 10-44  
   format ..... 10.4.11.2 ..... 10-44  
   level of detail ..... 10.4.11.3 ..... 10-44  
   location ..... 10.4.11.4 ..... 10-44  
   when to use ..... 10.4.11.1 ..... 10-44  
 on-line index of help topics  
     8.6.1.5.15 ..... 8-130
- Indicative sentences ..... 10.2.3.7.2 ..... 10-8
- Indicator(s)  
 failure ..... 6.12.2 ..... 6-82  
 open circuit ..... 6.12.2.4 ..... 6-82  
 out of range ..... 6.12.2.2 ..... 6-82  
 overload ..... 6.12.2.1 ..... 6-82  
 power failure ..... 6.12.2.3 ..... 6-82  
 power-on ..... 6.12.2.5 ..... 6-82  
 warm-up ..... 6.15.1.4.2 ..... 6-96
- Indicator lights ..... 7.2.2.3 ..... 7-17  
 coding, size, and color  
     7.2.2.3.3 ..... 7-17  
 for maintenance only  
     7.2.2.1.8 ..... 7-14  
 grouping of ..... 7.2.2.1.5 ..... 7-13  
 location of ..... 7.2.2.1.6, 7.2.2.1.7 ..... 7-13  
 spacing ..... 7.2.2.3.2 ..... 7-17  
 use of LEDs ..... 7.2.7.2 ..... 7-32  
 when to use ..... 7.2.2.3.1 ..... 7-17
- Inductive coil  
 built-in ..... 8.9.6.1.2.g ..... 8-155
- Industries  
 electrical ..... 5.3 ..... 5-9  
 nuclear energy ..... 5.3 ..... 5-9  
 petroleum ..... 5.3 ..... 5-9  
 process control ..... 5.3 ..... 5-9
- "Inflammable," use of in user documentation  
     10.2.4.3.4 ..... 10-13
- Information  
 protection ..... 11.5 ..... 11-9 - 11-11  
 suppression (*see* Suppression of information)
- Information message windows  
   behavior of window ... 8.3.10.2.8 ..... 8-76  
   8.3.10.2.9 ..... 8-76  
 Initial display ..... 8.2.1.7.1 ..... 8-44  
 starting point ..... 8.2.1.7.2 ..... 8-44
- Injury  
 cornea ..... 12.14.3 ..... 12-24  
 prevention ..... 6.2.8.1 ..... 6-12  
     6.3.4 ..... 6-17  
 retina ..... 12.14.3 ..... 12-24
- Input(s), minimized ..... 6.3.1.6 ..... 6-15
- Input device(s)  
 alternative devices .... 8.9.5.2 ..... 8-154  
 connection for ..... 8.9.3.1 ..... 8-153

- Input devices (computer)
- advantages of ..... 8.1 ..... 8-1 - 8-40
  - alternative devices ..... 8.8.4.1 ..... 8-146 - 8-147
    - appropriate type ... 8.8.4.1.2 ..... 8-147
    - consistent interaction
      - 8.8.4.1.1 ..... 8-146
      - optical character recognition
        - 8.8.4.1.2.b ..... 8-147
      - touch panel (*see* Touch panel)
      - voice control (*see* Voice, control)
      - voice input (*see* Voice, input)
    - disadvantages of ..... 8.1 ..... 8-1 - 8-40
    - feedback ..... 7.1.1.4 ..... 7-1
    - function keys (*see* Function keys)
    - interchangeability ..... 8.8.5 ..... 8-149
    - joystick (*see* Joystick)
    - keyboards (*see* Keyboards)
    - light pen (*see* Light pen)
    - mouse (*see* Mouse)
    - pointing devices (*see* Pointing devices)
    - stylus and grid (*see* Stylus and grid)
    - trackball (*see* Trackball)
  - Input focus ..... 8.3.4.3 ..... 8-60 - 8-61
    - active window ..... 8.3.4.2.1 ..... 8-53
    - assignment to an object
      - 8.3.4.3.7 ..... 8-61
    - assignment with keyboard
      - 8.3.4.3.4 ..... 8-60
    - assignment with pointing device
      - 8.3.4.3.3 ..... 8-60
    - location cursor ..... 8.3.4.3.5, 8.3.4.3.6 ..... 8-60
    - moving with pointing device
      - 8.3.4.3.8 ..... 8-61
    - one object at a time ... 8.3.4.3.5 ..... 8-60
    - one window at a time
      - 8.3.4.3.1 ..... 8-60
    - text cursor ..... 8.4.2.4.1 ..... 8-91
      - appearance ..... 8.3.8.1 ..... 8-68
      - initial location ..... 8.3.8.2 ..... 8-68
    - text cursor location ... 8.4.2.4.2 ..... 8-91
    - user assignment ..... 8.3.4.3.2 ..... 8-60
  - Insert mode
    - default mode for text entry
      - 8.3.8.6 ..... 8-69
    - for text entry ..... 8.4.2.2.1 ..... 8-90
    - text cursor ..... 8.4.2.4.1 ..... 8-91
      - 8.3.8.1 ..... 8-68
  - Instability ..... 6.3.3.1.4 ..... 6-16
  - Installation
    - accessibility ..... 6.3 ..... 6-13
    - ease of ..... 6.1.1.1 ..... 6-2
    - one-person ..... 6.3.1.5 ..... 6-14
  - Instruction(s) (*see also* Labels)
    - for bench mockups ... 6.15.6.8 ..... 6-100
    - for covers ..... 6.5.1.1 ..... 6-28
    - for menus ..... 8.1.11.1.10 ..... 8-21
      - 8.4.1.1.7 ..... 8-86
    - for portable test equipment
      - 6.15.2.3.5 ..... 6-97
    - for test panels ..... 6.15.2.4.4 ..... 6-98
    - location in displays ... 8.2.1.4.6 ..... 8-43
    - on tolerance limits .... 6.15.2.4.5 ..... 6-98
    - proceduralized ..... 10.5.1 ..... 10-48
      - illustrations ..... 10.5.1.4.3 ..... 10-52
      - procedures ..... 10.5.1.1 ..... 10-49
    - step statements ..... 10.5.1.1 ..... 10-49
      - 10.5.1.2.5 ..... 10-50
      - 10.5.1.3.1 ..... 10-51
  - Instruction placards ..... 10 ..... 10-1
  - Insulating high voltage areas
    - 6.15.1.2.7 ..... 6-95
  - Insulated gloves, providing
    - 12.4.1.2 ..... 12-7
  - Insulated tools
    - providing ..... 12.4.1.2 ..... 12-7
    - use ..... 12.4.5.1 ..... 12-13
  - Insulation, wire, clear plastic
    - 6.9.1.1.2 ..... 6-57
  - Integrated displays
    - diagnosis ..... 5.6.4 ..... 5-19
    - human interface ..... 5.6.4 ..... 5-19
    - status displays ..... 5.4.5 ..... 5-15
  - Integrated team players
    - automated subsystems
      - 5.3.1 ..... 5-10
  - Integration of displayed information
    - 5.3.7 ..... 5-13
    - 8.2.1.1.7 ..... 8-41
    - graphics ..... 5.6.4 ..... 5-19
  - Interaction(s) (*see also* User-computer interaction)
    - auditory counterparts . 8.9.6.2.4 ..... 8-155
    - human-computer ..... 4.3.6 ..... 4-5
    - human-human ..... 4.3.4 ..... 4-5
    - minimizing ..... 6.3.1.1 ..... 6-14
    - system ..... 4.3 ..... 4-4
  - Interaction method ..... 8.1.8 ..... 8-16 - 8-18
    - control information, display of
      - 8.1.8.2 ..... 8-18
    - hierarchical levels ..... 8.1.8.3 ..... 8-18
    - method
      - command language
        - 8.1.13 ..... 8-29 - 8-30
      - form-filling ..... 8.1.10 ..... 8-19
      - function keys ..... 8.1.12 ..... 8-26 - 8-29
      - interaction with icons
        - 8.1.15.1 ..... 8-36 - 8-37
      - menu selection ..... 8.1.11 ..... 8-19 - 8-26
      - natural language ... 8.1.14 ..... 8-31 - 8-36
      - query language .... 8.1.14 ..... 8-31 - 8-36
      - question-answer ... 8.1.9 ..... 8-19
      - selection of type ..... 8.1.8.1 ..... 8-16
      - when to list options ... 8.1.11.1.7 ..... 8-20
  - Interactive control (*see* Interaction user-computer)
  - Interchangeable
    - equipment ..... 6.3.1.2 ..... 6-14
      - 6.3.2 ..... 6-15
    - functionally ..... 6.3.2 ..... 6-15
    - items ..... 6.1.3.2 ..... 6-4
    - physically ..... 6.3.2 ..... 6-15
  - Interconnected units, testing of
    - 6.3.1.4 ..... 6-15
  - Interface(s)
    - human-computer ..... 8 ..... 8-1 - 8-157
    - human-security safeguard
      - distinctive ..... 4.1.58 ..... 4-5
      - 11.1.3 ..... 11-2
      - 11.6.2 ..... 11-11
  - Interlock(s) ..... 6.5.9 ..... 6-33
    - 6.6.5 ..... 6-36
    - 12.4.1 ..... 12-6

Interlock(s) (continued)

- bypassable ..... 12.4.1.9 ..... 12-8
  - 6.3.3.3.2 ..... 6-17
- for controls ..... 7.4.1.6.4.d ..... 7-62
- labeling ..... 6.5.9.3 ..... 6-33
- nonbypassable ..... 12.4.1.10 ..... 12-8
- on covers ..... 6.5.9.1 ..... 6-33
- on shields ..... 6.5.9.1 ..... 6-33
- override switch ..... 6.5.9.2 ..... 6-33
  - 6.6.5.2 ..... 6-37
  - 12.4.1.11 ..... 12-8
- removing power ..... 12.4.3.3 ..... 12-10
- simultaneous use of ... 6.5.9 ..... 6-33
  - 6.5.9.1 ..... 6-33
  - 6.5.9.2 ..... 6-33
  - 6.6.5 ..... 6-36
  - 6.6.5.1 ..... 6-37
  - 6.6.5.2 ..... 6-37
  - 12.4.1.11 ..... 12-8

Internal controls

- guards for ..... 7.4.1.6.2 ..... 7-62
- location ..... 6.15.1.2.6 ..... 6-95

International System of Units (of measurement)

- 10.2.4.11.1 ..... 10-14

Interrupts (in user-computer interactions)

- 8.1.3.3 ..... 8-7
- in editing forms ..... 8.4.3.7.4 ..... 8-97
- in message preparation, review, and disposition ..... 8.7.1.6 ..... 8-130
- no effect on stored or entered data ..... 8.1.4.2 ..... 8-9
- system interrupts ..... 8.1.3.3.1 ..... 8-7
- user control in windows ..... 8.1.1.21 ..... 8-3
- user-detected errors ... 8.1.5.1.1 ..... 8-10
- user interrupts ..... 8.1.4.1 ..... 8-9
- "working" message ... 8.1.3.3.2 ..... 8-7

Inverse video

- contrasting feature in displays ..... 8.2.1.4.7 ..... 8-43
- fields in forms ..... 8.4.3.2.1 ..... 8-92

Item(s) in a list

- consistency ..... 10.4.6.4 ..... 10-41
- marks ..... 10.4.6.3 ..... 10-41
- punctuation ..... 10.4.6.5 ..... 10-41

Item(s) in equipment

- interchangeability of ..... 6.1.3.2 ..... 6-4
- noninterchangeability of ..... 6.1.3.3 ..... 6-4

Item(s) in menus (*see* Options in menus)

Itemization within a paragraph

- 10.2.1.2.2 ..... 10-5

**J**

Jacking points ..... 6.2.2.8 ..... 6-7

- 6.2.10.1 - 6.2.10.3 ..... 6-13

J-bar handle ..... 6.2.5.3.1 ..... 6-10

Job performance aids ..... 10 ..... 10-1

- size ..... 10.3.1.1 ..... 10-19

Job-related experience (of document users)

- 10.1.1.1 ..... 10-2

Job-related skills, knowledge, duties (of document users)

- 10.1.1.1 ..... 10-2

Job-related training (of document users)

- 10.1.1.1 ..... 10-2

Joint mobility in models .. 14.1.6.5 ..... 14-15

- motion ..... 14.3.3.2 ..... 14-31 - 14-36

Joyball (*see* Ball controls)

Joystick(s) ..... 8.8.3.3 ..... 8-142

- activation ..... 8.8.3.3.2 ..... 8-143
- conformance ..... 8.8.3.3.1 ..... 8-143
- CRT refresh rate ..... 7.4.4.17.2 ..... 7-90
- deactivation ..... 8.8.3.3.2 ..... 8-143
- finger-operated, displacement ..... 7.4.4.18 ..... 7-90
  - mounting ..... 7.4.4.18.2 ..... 7-90
  - movement characteristics ..... 7.4.4.18.3 ..... 7-90
  - specifications ..... 7.4.4.18.1 ..... 7-90
- hand-operated, displacement ..... 7.4.4.17 ..... 7-89 - 7-90
- hand-operated, isometric ..... 7.4.4.20 ..... 7-92
  - mounting ..... 7.4.4.20.2 ..... 7-92
  - specifications ..... 7.4.4.20.2 ..... 7-92
- movement characteristics ..... 7.4.4.17.2 ..... 7-90
- specifications ..... 7.4.4.17.1 ..... 7-89
- thumbtip and fingertip-operated, isometric ..... 7.4.4.21 ..... 7-92
  - mounting ..... 7.4.4.21.1 ..... 7-92
- thumbtip and fingertip-operated, displacement ..... 7.4.4.19 ..... 7-91
  - mounting ..... 7.4.4.19.2 ..... 7-92
  - movement characteristics ..... 7.4.4.19.3 ..... 7-92
  - usage ..... 7.4.4.19.1 ..... 7-91
  - use of ..... 8.8.3.3.1 ..... 8-143
  - when not to use ..... 7.4.4.17.4 ..... 7-90
  - when to use ..... 7.4.4.17.3 ..... 7-90

Justification ..... 10.3.3.4 ..... 10-27 - 10-28

- alphanumeric data ..... 8.4.3.7.3.a ..... 8-96
- center-justification ..... 10.3.3.4.1 ..... 10-28
- decimal numeric data ..... 8.4.3.7.3.c ..... 8-96
- entries in forms ..... 8.4.3.7.3 ..... 8-96
- hyphenation ..... 10.3.3.4.3 ..... 10-28
- in tables in displays ..... 8.4.5.4 ..... 8-98
- integer numeric data .. 8.4.3.7.3.c ..... 8-96
- left-justification ..... 10.3.3.4.1 ..... 10-28
- right-justification ..... 10.3.3.4.1, 10.3.3.4.2 ..... 10-28
- text ..... 8.4.2.3.4 ..... 8-91

**K**

Key(s)

- color coding, in map windows ..... 8.3.12.4.5 ..... 8-83
- demarcation ..... 8.9.5.4 ..... 8-154
- for scale in map displays ..... 8.5.8.1.3 ..... 8-118
- for symbols in map displays ..... 8.5.8.2.7 ..... 8-119
- "Home" ..... 8.9.5.5 ..... 8-154
- in data display ..... 8.5.5.4.14 ..... 8-112
  - labels rather than keys ..... 8.5.5.4.15 ..... 8-112
  - location ..... 8.9.5.6 ..... 8-154
- nonvisual labeling ..... 8.9.4.3 ..... 8-153
- readability of ..... 7.4.4.9 ..... 7-78

Keyboard(s) ..... 8.9.5.5 ..... 8-154

- Keyboard(s) (continued)
- advantages and disadvantages
    - 8.1 ..... 8-1 - 8-3
  - alphanumeric ..... 7.4.4.9.3 ..... 7-78
  - assignment of input focus
    - 8.3.4.3.4 ..... 8-60
  - conformance with MIL-STD-1280
    - 8.8.1.1 ..... 8-139
  - consistency ..... 7.4.4.9.6 ..... 7-78
  - cursor control key layout
    - 7.4.4.9.5 ..... 7-78
  - disabled ..... 8.1.1.25 ..... 8-4
  - disabled during system startup
    - 8.3.9.1.4 ..... 8-70
  - equivalents to function keys
    - 8.8.1.7 ..... 8-139
  - equivalents to pointing device
    - 8.8.1.8 ..... 8-139
  - focus (*see* Input focus)
  - help availability ..... 8.3.12.1.1.e ..... 8-80
  - iconizing a window ... 8.3.5.10 ..... 8-63
  - layout ..... 8.8.1.3 ..... 8-139
  - moving a window ..... 8.3.5.4 ..... 8-62
  - moving text cursor ..... 8.4.2.4.3 ..... 8-91
  - ..... 8.3.8.3 ..... 8-69
  - numeric ..... 7.4.4.9.2 ..... 7-78
  - numeric keypads ..... 8.8.1.1, 8.8.1.2 ..... 8-139
  - opening an icon ..... 8.3.5.12 ..... 8-63
  - positive feedback ..... 7.4.4.9.7 ..... 7-79
  - QWERTY arrangement
    - 7.4.4.9.3 ..... 7-78
  - relevant keys only ..... 8.8.1.4 ..... 8-139
  - resizing a window ..... 8.3.5.7 ..... 8-63
  - two-dimensional cursor control
    - 7.4.4.9.5 ..... 7-78
  - when to use ..... 7.4.4.9.1 ..... 7-78
  - ..... 8.8.1.1 ..... 8-139
- Keyboard accelerators
- appearance ..... 8.3.7.2.5 ..... 8-66
  - case sensitivity ..... 8.3.7.2.7 ..... 8-66
  - consistency ..... 8.3.7.2.8 ..... 8-66
  - display of ..... 8.3.7.2.9 ..... 8-66
  - in a query language ... 8.1.14.4.4.c ..... 8-33
  - pull-down menu options
    - 8.3.7.2.1 ..... 8-65
  - selecting an option ..... 8.3.7.2.6 ..... 8-66
  - when to use ..... 8.3.7.2.5 ..... 8-66
- Keyboard lockout ..... 8.1.2.6
- 8.1.2.9 ..... 8-6
  - duration ..... 8.1.2.7 ..... 8-6
  - indication ..... 8.1.2.8 ..... 8-6
  - override ..... 8.1.2.9 ..... 8-6
  - response-time-induced
    - 8.1.2.6 ..... 8-6
- Key-operated switches ... 7.4.4.2 ..... 7-67
- ambient illumination .. 7.4.4.2.2 ..... 7-67
  - coding (color, shape, size)
    - 7.4.4.2.2 ..... 7-67
  - direction of rotation ... 7.4.4.2.7 ..... 7-68
  - key removal ..... 7.4.4.2.8 ..... 7-68
  - marking and labeling . 7.4.4.2.3 ..... 7-68
  - ON-OFF switches ..... 7.4.4.2.6
  - 7.4.4.2.8 ..... 7-68
  - specifications ..... 7.4.4.2.1 ..... 7-67
  - teeth on both edges of key
    - 7.4.4.2.4 ..... 7-68
  - teeth on single edge of key
    - 7.4.4.2.5 ..... 7-68
- Keyguard(s) ..... 8.9.2.8 ..... 8-152
- mounting ..... 8.9.8.6 ..... 8-157
- Keystrokes(s)
- acceptance of ..... 8.9.2.8 ..... 8-152
- Knee space ..... 9.4.4.5 ..... 9-42
- Knobs ..... 7.4.4.4 ..... 7-70
- combined with crank .. 7.4.4.7.2 ..... 7-75
  - control
    - coarse settings ..... 7.1.4.3 ..... 7-6
    - fine settings ..... 7.1.4.4 ..... 7-6
    - transilluminated ... 7.2.2.4.1.b ..... 7-18
  - distinguishability ..... 7.4.4.4.3 ..... 7-72
  - ganged ..... 7.4.4.5 ..... 7-72
  - inadvertent movement, critical
    - 7.4.4.5.6 ..... 7-73
  - inadvertent movement, noncritical
    - 7.4.4.5.7 ..... 7-73
  - knob-display association
    - 7.4.4.5.5 ..... 7-73
  - marking ..... 7.4.4.5.4 ..... 7-73
  - serrations ..... 7.4.4.5.3 ..... 7-73
  - specifications ..... 7.4.4.5.1 ..... 7-72
  - when to use ..... 7.4.4.5.2 ..... 7-72
  - pointer or marker ..... 7.4.4.4.2 ..... 7-70
  - ..... 7.4.4.4.3 ..... 7-72
  - shape coding ..... 7.4.4.4.3 ..... 7-62
  - specifications ..... 7.4.4.4.1 ..... 7-70
  - when to use ..... 7.4.4.4.2 ..... 7-70
- Knowledge-based aids .... 5.2.22 ..... 5-9
- ## L
- Label(s) (*See also* Controls, Labeling, Marking)
- 6.5.10 ..... 6-34
  - 6.7.4 ..... 6-47
  - 6.8.8 ..... 6-55
  - 6.9.1.8 ..... 6-64
  - 6.9.2.4 ..... 6-68
  - accessible ..... 6.15.1.3.1 ..... 6-95
  - access openings ..... 6.4.6 ..... 6-27
  - adjustable illumination for
    - 7.1.1.6 ..... 7-2
  - aligning ..... 6.2.8.5 ..... 6-12
  - bolts ..... 6.7.4.1 ..... 6-47
  - cable ..... 6.9.1.8.1 ..... 6-64
  - ..... 6.9.1.8.2 ..... 6-64
  - cases ..... 6.15.1.1.7 ..... 6-94
  - caution ..... 12.16.3 ..... 12-29
  - center of gravity ..... 12.16.14 ..... 12-31
  - classification ..... 12.16.3 ..... 12-29
  - connectors ..... 6.8.8.1 ..... 6-55
  - ..... 6.8.8.9 ..... 6-56
  - noninterchangeable
    - 6.8.8.2 ..... 6-55
  - consistency ..... 6.8.8.8 ..... 6-56
  - ..... 6.10.5.1 ..... 6-78
  - contents ..... 6.9.2.4.4 ..... 6-70
  - ..... 6.15.1.1.8 ..... 6-94
  - control-display relationships
    - 7.1.3.12 ..... 7-5
  - danger ..... 12.16.3 ..... 12-29
  - data ..... 6.3.5.1.5 ..... 6-20
  - data entry fields ..... 8.3.12.2.8 ..... 8-82
  - design of ..... 12.16.2 ..... 12-29

Label(s) (continued)		
electrical connections	6.8.8.10	6-56
elements in large-screen displays	6.9.1.8.1	6-64
emergency	7.2.5.1.6	7-29
equipment	12.16.3	12-29
fastener	6.2.2.10	6-7
fields in forms	6.3.5	6-19
fire	6.7.4.2	
for covers	- 6.7.4.4	6-47
for hazardous areas	8.4.3.3	8-93 - 8-94
function keys	12.16.3	12-29
gas line	6.5.10.1	6-34
general safety	12.16.7	12-31
graphic data displays	8.1.12.5, 8.1.12.6	8-27
hazard	12.16.12	12-31
icons	12.16.3	12-29
in displays	8.5.5.1.8	8-108
alphanumeric	6.3.5.1.2	6-20
areas	6.5.10.2	6-34
axes	6.8.8.9	6-56
consistent location and format	12.2.1.4	12-1
content	8.1.15.1.3	8-36
data elements	8.1.15.1.2	8-36
display identification		
format	8.5.2.2.2	8-103
frozen display	8.5.5.7.3	8-113
highlighting	8.5.5.4.10	8-111
lines and curves	8.5.2.2.3	8-104
location	8.5.6.6.2	8-117
scale divisions	8.5.5.4.14, 8.5.5.2.3	8-112
segments of pie charts	8.5.6.6.1	8-117
spacing	8.5.5.4.13	8-112
tick marks	8.5.7.3.2	8-118
wording	8.5.2.2.3	8-104
in legend lights	8.5.5.6.2	8-113
in map windows	8.5.6.6.2	8-117
editing	8.5.5.4.12	8-112
insertion holes	8.5.5.9.3	8-114
insulated wires	8.5.2.2.4	8-104
interlock	8.5.5.4.10	8-111
in transilluminated panels	8.5.1.10	8-102
jacking points	8.5.2.1.1	8-103
key-operated switches	7.2.2.2.4	7-16
laser	8.3.12.4.3,	
legend switches	8.3.12.4.4	8-83
legibility in map displays	8.3.12.4.8	8-84
levers	6.2.8.6	6-12
lifting eyes	6.4.6.4	6-27
liquid line	6.10.5.18	6-79
location of	6.3.5.1.4	6-20
map features	6.3.5.4.3	6-22
marks on circular scales	6.5.10.3	6-34
menu items selectable with function keys	6.9.1.8.1	6-64
microwave	7.2.3.2.9	7-21
miniature controls	8.1.12.18	8-33
"no-step"	12.16.8	12-31
OFF position of combined power and volume	7.4.4.25.4	7-96
controls	12.16.19	12-32
order of adjustments	7.3.5.4.3	7-51
orientation of	6.11.6	6-80
pages in a multipage display	6.3.5.2	6-20
parts	6.10.5.5	6-78
pins	6.10.5.17	6-79
placement	8.2.1.6.3	8-45
plugs	6.10.5.6, 6.10.5.7	6-78
position	6.8.5.1.12	6-52
push buttons	12.16.4	12-30
readability of	6.8.5.1.12	6-52
receptacle	6.9.2.4.5	6-70
rocker switches	6.10.5.3	6-78
safety	8.1.15.2.2	
placement	- 8.1.15.2.4	8-91
visibility of	6.3.5.2.1- 6.3.5.2.2	6-20
wording	12.16.13	12-31
scrolling tables	7.4.4.12.8	7-84
sliders	12.16.1	12-29
spare fuse holders	12.16.5	12-30
storage compartments	12.16.6	12-30
tables in displays	12.16.7	12-31
types of	8.4.5.8	8-66
typographical matters	8.1.15.5.4	8-94
use of	6.13.2.7	6-85
valve controls	6.15.7.4	6-100
weight	8.4.5.2	8-65
wording	6.3.5.1	6-19
X radiation	6.3.5.3	6-21
Labeling controls (ADA)	6.10.5.1	6-78
arrangement	7.4.1.2.3	7-58
avoid blue, green, violet to encode information	12.16.12	12-31
large lettering and labels	6.3.5.4	6-22
raised lettering	12.16.9	12-31
read from wheelchair	7.6.3.11	7-112
special operation keycaps	7.6.3.11	7-112
redundant speech	7.6.3.11	7-112
Labeling laser goggles	12.15.4	12-28

Ladder(s) .....	9.3.5 .....	9-19	for people with disabilities	8.9.2.7 .....	8-152
construction materials				6.7.3.4 .....	6-43
9.3.5.2.1 .....	9.3.5.2.1 .....	9-20	location .....	6.7.3.4.5 .....	6-43
9.3.5.6.4 .....	9.3.5.6.4 .....	9-28	6.7.3.4.6 .....	6.7.3.4.6 .....	6-44
de-icing .....	12.2.2.7 .....	12-4	not to be used .....	12.5.1.7 .....	12-15
design requirements ..	9.3.5.2 .....	9-20	positive catch .....	6.7.3.4.1 .....	6-43
entrances to catwalk ..	9.3.2.4 .....	9-10	spring-loaded .....	6.7.3.4.3	
fixed			- 6.7.3.4.4 .....	6.7.3.4.4 .....	6-43
between floors .....	9.3.5.6.2 .....	9-26	visual indication .....	6.7.3.4.2 .....	6-43
cages on .....	9.3.5.6.2 .....	9-26	Layout ( <i>see also</i> Formatting)		
dimensions for .....	9.3.5.6.1 .....	9-26	of equipment .....	6.3 .....	6-13 - 6-23
rungs vs. steps .....	9.3.5.6.3 .....	9-28	of internal components		
tread rise .....	9.3.5.6.4 .....	9-28	6.10 .....	6.71 - 6.79	
nonskid materials on ..	9.3.5.2.3 .....	9-21	of user documentation		
portable .....	9.3.5.7 .....	9-28	10.3 .....	10-19 - 10-31	
dimensions for .....	9.3.5.7.1 .....	9-28	Laser		
feet .....	9.3.5.7.4 .....	9-30	alignment .....	12.15.6 .....	12-29
two-section .....	9.3.5.7.3 .....	9-30	dust .....	12.15.7 .....	12-29
weight of .....	9.3.5.7.2 .....	9-30	equipment .....	12.15.1 .....	12-28
safety devices on .....	9.3.5.6.2 .....	9-26	12.15.7 .....	12.15.7 .....	12-29
selection of .....	9.3.5.1.1 .....	9-19	exposure limits .....	12.15.2 .....	12-28
step .....	9.3.5.7.1 .....	9-28	eye protection .....	12.15.3 .....	12-28
strength of .....	9.3.5.2.2 .....	9-20	fog .....	12.15.7 .....	12-29
telescoping .....	12.2.2.6 .....	12-4	goggles .....	12.15.4 .....	12-28
warning labels on .....	9.3.5.2.4 .....	9-21	hazards .....	12.15 .....	12-28
when not to use .....	9.3.5.1.3.c .....	9-20	labeling .....	12.15.4 .....	12-28
when to use .....	9.3.5.1.2 .....	9-20	12.16.11 .....	12.16.11 .....	12-31
Lamps			operators qualification	12.15.5 .....	12-29
in legend switches .....	7.4.4.11.5 .....	7-82	optical density .....	12.15.3, 12.15.4 .....	12-28
in transilluminated displays			personnel safety .....	12.15.7 .....	12-29
redundancy .....	7.2.2.1.14 .....	7-14	rain .....	12.15.7 .....	12-29
removal .....	7.2.2.1.17 .....	7-15	snow .....	12.15.7 .....	12-29
replacement .....	7.2.2.1.17 .....	7-15	warnings .....	12.16.11 .....	12-31
7.2.2.4.3 .....	7.2.2.4.3 .....	7-18	Leads		
testing .....	7.2.2.1.15 .....	7-14	adequate slack .....	6.9.1.2.6 .....	6-59
Language ( <i>see also</i> Command language, Wording)			"cold"		
clear, simple .....	10.2.3.1.1 .....	10-8	in plug .....	6.8.5.1.6 .....	6-51
disabilities .....	10.6.4 .....	10-67	"hot"		
nonsexist .....	10.2.3.1.3 .....	10-8	in receptacle .....	6.8.5.1.6 .....	6-51
Large-screen displays .....	7.2.5 .....	7-28 - 7-31	not exposed .....	6.8.5.1.5 .....	6-51
displayed information			12.4.1.17 .....	12.4.1.17 .....	12-9
content .....	7.2.5.1.6 .....	7-29	length of .....	6.8.5.2.1 .....	6-52
control of .....	7.2.5.1.5 .....	7-29	6.9.1.2.5 .....	6.9.1.2.5 .....	6-56
critical .....	7.2.5.1.5 .....	7-29	mounting .....	6.9.1.4.5 .....	6-62
optical projection .....	7.2.5.2 .....	7-30 - 7-31	spacing of .....	6.8.5.2.2 .....	6-53
ambient illumination			stored charges in .....	6.8.5.1.7 .....	6-51
7.2.5.2.1, 7.2.5.2.4 .....	7.2.5.2.1, 7.2.5.2.4 .....	7-30	Leading zeros ( <i>see</i> Zeros)		
character size .....	7.2.5.2.6 .....	7-31	Leakage		
character style .....	7.2.5.2.5 .....	7-30	control .....	6.8.6.4 .....	6-54
distance-size ratio ..	7.2.5.2.2 .....	7-30	tests .....	6.8.6.3 .....	6-54
image luminance ..	7.2.5.2.4 .....	7-30	LEDs ( <i>see</i> Light emitting diodes)		
luminance ratio .....	7.2.5.2.7, 7.2.5.2.8 .....	7-31	Left-handed pages .....	10.3.2.5 .....	10-23
viewing angle .....	7.2.5.2.3 .....	7-30	even numbered .....	10.3.2.5.2 .....	10-23
when to use .....	7.2.5.2.1 .....	7-30	Legend(s) ( <i>see also</i> Labels)		
unobstructed view .....	7.2.5.1.4 .....	7-29	for flags .....	7.2.9.4.6 .....	7-41
viewing angle .....	7.2.5.1.2 .....	7-29	for lines and curves in displays		
7.2.5.2.3 .....	7.2.5.2.3 .....	7-30	8.5.5.6.2 .....	8.5.5.6.2 .....	8-113
viewing distance .....	7.2.5.1.2, 7.2.5.1.3 .....	7-29	for map displays .....	8.5.8.3.21 .....	8-122
7.2.5.2.2 .....	7.2.5.2.2 .....	7-30	for visual tiles .....	7.2.1.5.9 .....	7-10
when not to use .....	7.2.5.1.2 .....	7-29	labels rather than legends		
when to use .....	7.2.5.1.1 .....	7-29	8.5.5.4.14 .....	8.5.5.4.14 .....	8-112
Large-screen displays, optical projection			location .....	8.5.5.4.15 .....	8-112
alignment (registration)			Legend light(s) .....	7.2.2.2 .....	7-15 - 7-17
7.2.5.2.10 .....	7.2.5.2.10 .....	7-31	color coding .....	7.2.2.2.2 .....	7-15
distortion .....	7.2.5.2.11 .....	7-31			
superimposed images	7.2.5.2.9 .....	7-31			
Latches .....	6.2.9.4 .....	6-13			

Legend light(s) (continued)			
label illumination vs. background illumination			
7.2.2.2.4	7-16		
lettering of legends	7.2.2.2.5	7-16	
multi-legend indicators			
7.2.2.2.7	7-17		
size	7.2.2.2.3	7-15	
use of LEDs	7.2.7.2	7-32	
visibility and legibility of legend			
7.2.2.2.6	7-16		
when to use	7.2.2.2.1	7-15	
Legend switch(es)	7.4.4.11	7-81	
barriers	7.4.4.11.2	7-81	
cover replacement	7.4.4.11.6	7-82	
lamp replacement	7.4.4.11.5	7-82	
legend legibility	7.4.4.11.4	7-82	
legends	7.4.4.11.7	7-82	
positive feedback	7.4.4.11.3	7-81	
specifications	7.4.4.11.1	7-81	
Legibility			
in CRT displays	7.2.4.6.1	7-26	
of displays	7.2.1.1.2	7-6	
of legend in legend lights			
7.2.2.2.6	7-16		
of legend in legend switches			
7.4.4.11.4	7-82		
Length			
of leads	6.9.1.2.5	6-59	
paragraph	10.2.2.4	10-6	
sentence	10.2.3.3	10-7	
Letter(s) ( <i>see Case</i> )			
Level ( <i>see Height</i> )			
Level of experience ( <i>see Experience, level of</i> )			
Level of training ( <i>see Training, level of</i> )			
Lever(s)	7.4.4.16	7-87 - 7-89	
coarse setting	7.1.4.6, 7.1.4.7	7-6	
coding	7.4.4.16.3	7-89	
labeling	7.4.4.16.4	7-89	
limb support	7.4.4.16.5	7-89	
location	12.5.1.8	12-15	
releasing energy	12.3.5	12-5	
specifications	7.4.4.16.1	7-87	
two-dimensional setting			
7.1.4.7	7-6		
when to use	7.4.4.16.2	7-89	
Lexicon	10.2.4.1.1	10-12	
Lifesaving equipment, accommodating size range			
14.1.2.7	14-7		
Life support equipment, accommodating size range			
14.1.2.10	14-8		
Lifting	6.2.2	6-6	
14.5.4	14-52		
by one person			
with obstacles	6.2.2.2	6-6	
without obstacles	6.2.2.1	6-6	
by three or more people			
6.2.2.4	6-6		
by two people	6.2.2.3	6-6	
components of	14.5.4	14-52	
eyes	6.2.2.8	6-7	
6.2.10.1 - 6.2.10.3	6-13		
Light(s)			
diffusers	13.4.4.1.c	13-11	
dimming	13.4.1.2	13-8	
emergency	13.4.7.1	13-13	
polarized	13.4.4.1	13-11	
portable	13.4.7.7	13-14	
shields	13.4.3.2.c	13-11	
13.4.4.1.c	13-11		
sources			
arranging	13.4.5.3	13-12	
flickering	13.4.7.5	13-14	
glare from	13.4.4.1.a	13-11	
placement	13.4.5.5	13-12	
protecting	13.4.7.6	13-14	
Light emitting diode(s)	7.2.7	7-32 - 7-33	
applicable criteria and guidelines			
7.2.7.1	7-32		
color coding	7.2.7.4	7-33	
intensity control	7.2.7.3	7-33	
red alphanumeric displays			
7.2.7.6	7-33		
when to use	7.2.7.2	7-32	
Lighting			
controls	13.4.7.2		
- 13.4.7.4	13-13 - 13-14		
fixtures	13.4.7	13-13 - 13-14	
general	13.4.1.1	13-8	
indirect	13.4.4.1.d	13-11	
levels			
13.4.2.1	13-8		
13.4.3.2.a	13-10		
sources	13.4.2.3	13-8	
supplemental	13.4.1.1	13-8	
Light pen	8.8.3.4	8-143	
activation	8.8.3.4.3	8-143	
appropriate use	8.8.3.4	8-143	
dimensions	8.8.3.4.3	8-143	
dynamic characteristics			
8.8.3.4.1	8-143		
feedback	8.8.3.4.4	8-143	
mounting	8.8.3.4.2	8-143	
Limiting dimensions	9.1.2	9-1	
1st percentile	9.3.4.5.6	9-17	
14.1.2.7	14-7		
5th percentile	9.4.1	9-31	
14.1.2.6	14-7		
Limit stops in controls	7.4.1.1.4	7-54	
Line(s) ( <i>see also Cable</i> )			
accessibility	6.9.1.3.8		
- 6.9.1.3.9	6-61		
coding	6.9.2.4.3	6-70	
combining into cables			
6.9.1.3.2	6-60		
design	6.9.1.1.3	6-57	
distance to ground	6.9.1.3.5	6-61	
electrical			
mounting	6.9.1.1.1	6-57	
routing	6.9.1.1.1	6-57	
fluid			
mounting	6.9.2.2	6-67	
routing	6.9.2.2	6-67	
fuel			
routing	6.9.2.2.4	6-68	
gas			
mounting	6.9.2.2	6-67	
routing	6.9.2.2	6-67	
high-pressure	6.9.2.1.9	6-67	
6.9.2.2.3	6-68		
in graphic data displays			
8.5.5.6	8-113		
coding	8.5.5.6.3, 8.5.5.6.5	8-113	
constraining	8.4.6.2.2	8-99	
drawing	8.4.6.2.1	8-99	
8.5.5.3.5	8-109		

- Line(s) (continued)
- highlighting ..... 8.5.5.6.2 ..... 8-113
    - joining ..... 8.5.5.3.7 ..... 8-109
    - labeling ..... 8.5.5.6.2 ..... 8-113
    - segments ..... 8.5.5.3.8 ..... 8-109
    - use of ..... 8.5.5.6.1 ..... 8-113
  - lightly insulated ..... 6.9.1.3.5 ..... 6-61
    - protection ..... 6.9.1.1.11
      - 6.9.1.1.12 ..... 6-58
    - spare ..... 6.9.1.1.6 ..... 6-57
    - support ..... 6.9.2.3.1 ..... 6-68
    - text
      - breaks ..... 8.4.2.3.3 ..... 8-91
      - spacing between ... 8.2.3.5 ..... 8-48
  - Line coding ..... 8.5.4.7 ..... 8-107
    - direction ..... 8.5.4.7.2 ..... 8-74
    - length ..... 8.5.4.7.1 ..... 8-107
  - Line drawings (in user documentation)
    - 10.4.4.4.2 ..... 10-36
  - Line length ..... 10.3.3.2 ..... 10-27
  - Line of sight
    - for visual tasks ..... 14.1.4.5 ..... 14-10
    - to panels ..... 9.5.3.1 ..... 9-47
  - Line spacing
    - in control labels ..... 7.5.3.8 ..... 7-100
    - minimum ..... 10.3.3.3.1 ..... 10-27
  - Linking sentences ..... 10.2.2.2 ..... 10-7
  - Lists (in displays)
    - numbering items in multidisplay lists
      - 8.5.6.6.4 ..... 8-117
    - in text ..... 8.2.1.5.2 ..... 8-43
    - of allowable entries ... 8.6.1.1.3 ..... 8-126
    - of valid entries ..... 8.6.1.3.4 ..... 8-128
  - Lists (in user documentation)
    - 10.1.2.5 ..... 10-3
    - 10.4.6 ..... 10-41
    - format ..... 10.4.6.2 ..... 10-41
    - items
      - consistency ..... 10.4.6.4 ..... 10-41
      - marks ..... 10.4.6.3 ..... 10-41
      - punctuation ..... 10.4.6.5 ..... 10-41
      - when to use ..... 10.4.6.1 ..... 10-41
  - Lists (of exhibits in user documentation)
    - 10.4.3 ..... 10-35
    - contents ..... 10.4.3.2 ..... 10-35
    - location ..... 10.4.3.3 ..... 10-35
    - precedence ..... 10.4.3.3 ..... 10-35
    - when to use ..... 10.4.3.1 ..... 10-35
  - List orientation (in user documentation)
    - 10.2.1.5.2 ..... 10-7
  - Location
    - coding of controls ..... 7.4.1.4.2 ..... 7-60
    - of covers ..... 6.5.4 ..... 6-30
    - of displayed help ..... 8.6.1.1.6 ..... 8-126
    - of equipment ..... 6.3.4 ..... 6-17
    - of labels ..... 6.3.5.2 ..... 6-20
  - Location cursor (*see* Cursor, location)
  - Lock(s)
    - for controls ..... 7.4.1.6.4.f ..... 7-59
    - on drawers ..... 6.3.3.2.2 ..... 6-16
    - on sliders ..... 6.3.3.2.2 ..... 6-16
    - release ..... 6.3.3.2.3 ..... 6-17
  - Locking bar ..... 6.7.3.5.7 ..... 6-45
  - Lockout (*see also* Keyboard lockout)
    - simultaneous use of ... 6.5.9 ..... 6-33
      - 6.5.9.1 ..... 6-33
      - 6.5.9.2 ..... 6-33
      - 6.6.5 ..... 6-36
      - 6.6.5.1 ..... 6-37
      - 6.6.5.2 ..... 6-37
      - 12.4.2.2 ..... 12-9
  - Log
    - of incoming messages
      - 8.3.12.5.9 ..... 8-85
      - 8.7.6.1.2 ..... 8-134
    - of message transmissions
      - 8.3.12.5.7 ..... 8-85
      - 8.7.5.1.1 ..... 8-133
  - Logical combinations
    - "and," "or," and "not" in data base queries
      - 8.1.14.1.7 ..... 8-31
  - Logical flow packaging, use of
    - 6.10.2.2.2 ..... 6-73
  - Logic diagram symbols (in user documentation)
    - 10.2.4.13.3 ..... 10-18
  - Log off
    - application ..... 8.2.2.3 ..... 8-47 - 8-48
    - automatic ..... 8.3.9.1.6 ..... 8-70
    - auditory signal ..... 8.3.9.1.6 ..... 8-70
    - saving data ..... 8.3.9.1.6 ..... 8-70
    - user-specified interval
      - 8.3.9.1.6 ..... 8-70
    - "Close" ..... 8.2.2.3.2 ..... 8-47
    - completion ..... 8.2.2.2.9 ..... 8-47
      - 8.2.2.3.5 ..... 8-48
      - 8.3.9.1.5 ..... 8-70
    - confirmation ..... 8.2.2.2.8 ..... 8-47
    - display of log on window
      - 8.3.9.1.5 ..... 8-70
    - "Exit" ..... 8.2.2.3.2 ..... 8-47
    - prompt to exit application
      - 8.2.2.2.7 ..... 8-47
      - 8.3.9.1.5 ..... 8-70
    - prompt to save entries
      - 8.2.2.2.7 ..... 8-47
      - 8.3.9.1.5 ..... 8-70
    - system ..... 8.2.2.2.6 ..... 8-47
    - unfinished work ..... 8.2.2.3.4 ..... 8-48
    - user-initiation ..... 8.3.9.1.1 ..... 8-69
  - Log on
    - application ..... 8.2.2.2 ..... 8-47
      - 8.3.9.1.1 ..... 8-69
    - attempts ..... 11.3.1.6 ..... 11-5
      - 11.3.1.8 ..... 11-5
    - completion ..... 8.2.2.2.5 ..... 8-47
    - delay ..... 11.3.1.5 ..... 11-5
    - echoing ..... 8.2.2.2.2 ..... 8-47
    - errors ..... 8.2.2.2.4 ..... 8-47
      - 11.3.1.8 ..... 11-5
    - minimizing ..... 11.3.1.8 ..... 11-5
    - password ..... 8.2.2.2.3 ..... 8-47
    - procedure ..... 8.3.9.1.3 ..... 8-69
      - 8.2.2.2.2 ..... 8-47
    - process ..... 11.3.1.3 ..... 11-5
    - prompts ..... 8.2.2.2.2 ..... 8-47
      - 11.3.1.4 ..... 11-5
    - recording date and time at
      - 11.3.2.4 ..... 11-8





- Maintenance tasks ..... 9.4.3.1 ..... 9-38
  - design compatibility .. 4.2.1.e ..... 4-3
  - identifying ..... 6.4.6.2 ..... 6-27
  - lighting for ..... 12.2.1.8 ..... 12-3
  - minimizing ..... 6.1.1.1.c ..... 6-2
  - performing ..... 6.3.e ..... 6-13
    - 6.4.1.1 ..... 6-23
    - 6.4.5.2 ..... 6-27
    - 6.4.5.4 ..... 6-27
    - 6.5.4.1 ..... 6-30
- requiring visual access ..... 6.4.2.2 ..... 6-24
- using carts (work stands) ..... 6.4.5.6 ..... 6-27
- Management
  - access to database ..... 5.9.7 ..... 5-27
  - database pruning ..... 5.9.1 ..... 5-25
  - logging ..... 5.9.3 ..... 5-26
    - 5.9.4 ..... 5-26
    - 5.9.5 ..... 5-26
    - 5.9.6 ..... 5-26
  - maintenance technician resources ..... 5.9.8 ..... 5-27
  - plans and events ..... 5.9.10 ..... 5-27
  - separate information and control ..... 5.9.9 ..... 5-27
  - tracking change ..... 5.9.3 ..... 5-26
  - unnecessary data ..... 5.9.2 ..... 5-26
  - with automation tasks ..... 5.2.8 ..... 5-6
    - by entry ..... 5.2.4 ..... 5-5
    - by exception ..... 5.2.8 ..... 5-6
    - by intention ..... 5.2.4 ..... 5-4
    - by proactive cross checking ..... 5.2.8 ..... 5-6
- Manikins, drawing board ..... 14.1.6 ..... 14-14
- Manipulating data
  - support of people with disabilities ..... 8.9.1.3 ..... 8-151
- Manipulation, understanding
  - adjustable timing ..... 7.6.1.4 ..... 7-105
  - cues, prompts ..... 7.6.1.4 ..... 7-105
  - instructions ..... 7.6.1.4 ..... 7-105
- Manuals ..... 10.6.1 ..... 10-63
- Manufacturing tolerances
  - design principle ..... 4.2.11 ..... 4-4
- Map displays (*see also* Windows, map)
  - 8.5.8 ..... 8-118 - 8-123
  - cursor ..... 8.5.8.5.2 ..... 8-123
  - dynamic display attributes ..... 8.5.8.3 ..... 8-120 - 8-122
    - freezing ..... 8.5.8.3.15 ..... 8-121
    - 8.5.8.3.17 ..... 8-122
    - panning ..... 8.5.8.3.1 - 8.5.8.3.3 .. 8-120
    - selecting information for updating ..... 8.5.8.3.10 ..... 8-121
    - stable reference points ..... 8.5.8.3.11 ..... 8-121
    - updating ..... 8.5.8.3.12 ..... 8-121
      - 8.5.8.3.15 ..... 8-121
    - user control of sequencing ..... 8.5.8.3.16 ..... 8-121
      - 8.5.8.3.18 ... 8-121 - 8-122
    - zooming ..... 8.5.8.3.4 ..... 8-121
      - 8.5.8.3.9 ..... 8-120 - 8-121
  - filters ..... 8.5.8.5.2 ..... 8-123
  - general ..... 8.5.8.1 ..... 8-118 - 8-119
    - amount of detail ... 8.5.8.1.2 ..... 8-118
    - automated tools ... 8.5.8.1.10 ..... 8-119
    - coding map areas .. 8.5.8.1.9 ..... 8-119
    - consistent label position ..... 8.5.8.1.7 ..... 8-119
    - consistent orientation ..... 8.5.8.1.8 ..... 8-119
    - curvature treatment ..... 8.5.8.1.4 ..... 8-118
    - labeling features ... 8.5.8.1.6 ..... 8-119
    - map manipulation tools ..... 8.5.8.1.3 ..... 8-118
    - situation displays as overlays ..... 8.5.8.1.5 ..... 8-118
    - user expectations .. 8.5.8.1.1 ..... 8-118
  - graphics, creating and editing ..... 8.5.8.4 ..... 8-122 - 8-123
    - attribute change .... 8.5.8.4.8, 8.5.8.4.9 ... 8-123
    - attribute identification ..... 8.5.8.4.7 ..... 8-123
    - editing displays ..... 8.5.8.4.4 ..... 8-122
    - 8.5.8.4.6 ..... 8-122
    - expanding an area of a display ..... 8.5.8.4.5 ..... 8-122
    - labeling symbols ... 8.5.8.4.2 ..... 8-122
    - library of standard symbols ..... 8.5.8.4.1 ..... 8-122
    - print preview ..... 8.5.8.4.10 ..... 8-123
    - tools for constructing symbols and overlays ..... 8.5.8.4.3 ..... 8-122
  - grid overlay ..... 8.5.8.3.20 ..... 8-122
  - intensity controllable . 8.5.8.5.6 ..... 8-123
  - legend ..... 8.5.8.3.21 ..... 8-122
  - map as background .... 8.5.8.5.7 ..... 8-123
  - not obscured ..... 8.5.8.5.1 ..... 8-123
  - overlays ..... 8.5.8.5.4, 8.5.8.5.5 ... 8-123
  - 8.5.8.5.7 ..... 8-123
  - 8.5.8.5.6 ..... 8-123
  - selecting displays for viewing ..... 8.5.8.3.19 ..... 8-122
  - static display attributes ..... 8.5.8.2 ..... 8-119 - 8-120
    - association of symbols with features ..... 8.5.8.2.5 ..... 8-119
    - context for displayed map ..... 8.5.8.2.13 ..... 8-120
    - determining bearings ..... 8.5.8.2.15 ..... 8-120
    - determining coordinates ..... 8.5.8.2.12 ..... 8-120
    - determining distances ..... 8.5.8.2.14 ..... 8-120
    - labeling symbols ... 8.5.8.2.10 ..... 8-120
    - label legibility ..... 8.5.8.2.3 ..... 8-119
    - map coverage ..... 8.5.8.2.1 ..... 8-119
    - necessary features . 8.5.8.2.2 ..... 8-119
    - nonoverlapping of symbols ..... 8.5.8.2.9 ..... 8-120
    - reading coordinates ..... 8.5.8.2.11 ..... 8-120
    - reducing clutter ..... 8.5.8.2.4 ..... 8-119
    - registration of data with map ..... 8.5.8.2.6 ..... 8-119
    - symbol identification key ..... 8.5.8.2.7 ..... 8-119

Map displays (continued)	
symbol color coding .. 8.5.8.2.8 .....	8-120
text .. 8.5.8.5.4 .....	8-123
Map windows, ( <i>see</i> Windows, map)	
Margins (page) .. 10.3.2.1 .....	10-20 - 10-21
consistency .. 10.3.2.1.1 .....	10-20
for 8.5 x 11 inch pages	
10.3.2.1.1 .....	10-20
for pages smaller than 8.5 x 11 inches	
10.3.2.1.3 .....	10-20
headers and footers .... 10.3.2.2.4 .....	10-22
offset for binding .. 10.3.2.1.4 .....	10-21
"Mark"	
query language control operation	
8.1.14.5.2.a .....	8-34
Market investigation	
COTS and NDI .. 1.3.2 .....	1-2
Marking(s), ( <i>see also</i> Controls, labeling, and marking)	
arrows .. 6.3.5.5.3 .....	6-23
colors .. 6.3.5.5.2 .....	6-22
durability .. 6.10.5.12 .....	6-79
electrical equipment .. 6.3.5.1 .....	6-19
enclosed parts .. 6.10.5.14 .....	6-79
functional groups of controls and displays	
7.1.2.4 .....	7-1
ganged control knobs	
7.4.4.5.4 .....	7-73
key-operated switches	
7.4.4.2.3 .....	7-68
number of .. 6.3.5.5 .....	6-22
symmetric parts .. 6.10.5.17 .....	6-79
Master caution, warning, and advisory indicators	
7.2.1.5.10 .....	7-10
7.2.2.1.5 .....	7-13
Master summation lights . 7.2.2.1.5 .....	7-13
7.2.2.2.3 .....	7-15
Materials handling ( <i>see</i> space for weight)	
9.2.1.12 .....	9-4
9.3.1.2 .....	9-8
"Maximize"	
control, title bar .. 8.3.2.2.1 .....	8-56
in window menu .. 8.3.2.4.2 .....	8-57
operation .. 8.3.5.13 .....	8-63
Maximum control forces (ADA)	
7.6.3.2 .....	7-110
"May"	
in user documentation	
10.2.4.5.2 .....	10-14
Measurement, human characteristics	
applying .. 14.1.5.3 .....	14-14
constructing .. 14.1.4.2 .....	14-9
selecting .. 14.1.2.1 .....	14-3
static .. 14.3.2.1 .....	14-16
Measurement, units of .... 1.4.1.2 .....	1-3
abbreviation of .. 10.2.4.8.7 .....	10-16
alternative units for fields in forms	
8.4.3.3.8 .....	8-94
conversion .. 10.2.4.11.2 .....	10-17
in control labels .. 7.5.1.14 .....	7-98
in labels of fields in forms	
8.4.3.3.7 .....	8-94
in tables .. 10.4.5.4.4 .....	10-39
International System of Units	
10.2.4.11.1 .....	10-17
"inch-pound" units .... 10.2.4.11.1 .....	10-17
punctuation of .. 10.2.4.8.7 .....	10-16
Measurement value for body part	
14.1.3.2 .....	14-8
Mechanical diagrams (in user documentation)	
10.4.4.5.3 .....	10-37
Mechanical part symbols (in user documentation)	
10.2.4.13.2 .....	10-18
Medium voltage guarding	
12.4.1.12 .....	12-8
Memory load	
data transmission procedures	
8.7.1.3 .....	8-130
minimizing .. 8.1.1.12 .....	8-2
8.1.6.2 .....	8-14
8.2.1.8.1 .....	8-44
workload .. 5.1.6 .....	5-3
Mental models .. 5.3.6 .....	5-12
understanding automation	
5.3.6 .....	5-12
users cognitive model	
5.3.6 .....	5-12
Menu(s), ( <i>see also</i> Menu bar(s), Menu selection interaction method, Menus in windows, Options in menus)	
consistent ordering .... 8.4.1.1.2 .....	8-85
consistent style .. 8.1.11.1.2 .....	8-20
8.4.1.1.1 .....	8-85
consistent wording .... 8.4.1.1.2 .....	8-85
control, in application windows	
8.3.10.1.1.b .....	8-72
data entry .. 8.4.1 .....	8-85
display of all options . 8.1.11.1.7 .....	8-20
distinctive appearance	
8.1.11.1.13 .....	8-21
8.4.1.1.8 .....	8-86
error messages .. 8.1.11.1.10 .....	8-21
formatting .. 8.1.11.2 .....	8-21 - 8-22
consistency .. 8.1.11.2.2 .....	8-21
hierarchical menus .... 8.1.11.3 .....	8-22
bypassing selections	
8.1.11.3.13 .....	8-23
consistency .. 8.1.11.3.3 .....	8-22
current position .... 8.1.11.3.6 .....	8-22
important options .. 8.1.11.3.5 .....	8-22
in graphical user interfaces	
8.1.11.3.7 .....	8-22
labeling of .. 8.1.11.3.2 .....	8-22
lower level menus . 8.1.11.3.12 .....	8-23
navigation aids .... 8.1.11.3.14 .....	8-23
number of levels .. 8.1.11.3.4 .....	8-22
organization of .... 8.1.11.3.2 .....	8-22
return to next higher level	
8.1.11.3.11 .....	8-23
system-level menu	
8.1.11.3.9 .....	8-23
8.1.11.3.10 .....	8-23
top level menu .... 8.1.11.3.8 .....	8-23
when to use .. 8.1.11.3.1 .....	8-22
8.4.1.2.1 .....	8-86
icon .. 8.1.15.1.8, 8.1.15.1.9 .	8-37
instructions for .. 8.1.11.1.10 .....	8-21
number of options .... 8.1.11.1.6 .....	8-20
pop-up .. 8.1.11.6 .....	8-24
location .. 8.1.11.6.2 .....	8-24
8.4.1.4.2 .....	8-87
option selection using pointing device	
8.1.11.6.3 .....	8-24

- Menu(s) (continued)
  - selection highlighting
    - 8.4.1.4.3 ..... 8-87
    - when to use ..... 8.1.11.6.1 ..... 8-24
  - pull-down ..... 8.1.11.5 ..... 8-23 - 8-24
    - 8.3.7.3 ..... 8-66 - 8-67
    - consistent location
      - 8.1.11.5.2 ..... 8-24
      - 8.4.1.3.2 ..... 8-87
    - distinguishing unavailable options
      - 8.3.7.3.7 ..... 8-67
    - grouping options .. 8.3.7.3.3 ..... 8-67
    - keyboard accelerators
      - 8.3.7.2.1 ..... 8-65
    - mnemonics ..... 8.3.7.2.1 ..... 8-65
    - navigation ..... 8.3.7.3.4 ..... 8-67
    - number of options ..... 8.3.7.3.6 ..... 8-67
    - when to use ..... 8.1.11.5.1 ..... 8-23
      - 8.4.1.3.1 ..... 8-87
    - options ..... 8.3.7.3.5 ..... 8-67
    - ordering options .. 8.3.7.3.3 ..... 8-67
    - presentation of options
      - 8.3.7.3.2 ..... 8-67
    - selection of options
      - 8.3.7.3.4 ..... 8-67
    - title ..... 8.3.7.3.1 ..... 8-66
  - scrollable ..... 8.4.1.1.3, 8.4.1.1.4 ..... 8-86
    - display of all options
      - 8.4.1.1.4 ..... 8-86
    - when to use ..... 8.4.1.1.3 ..... 8-86
  - scrolling ..... 8.3.7.4 ..... 8-67 - 8-68
    - display of all options
      - 8.3.7.4.4 ..... 8-68
    - editing ..... 8.3.7.4.6 ..... 8-68
    - format ..... 8.3.7.4.1 ..... 8-68
    - number of options displayed
      - 8.3.7.4.3 ..... 8-68
    - search capability ... 8.3.7.4.5 ..... 8-68
    - when to use ..... 8.2.1.8.2 ..... 8-44
      - 8.2.1.8.3 ..... 8-44
  - selecting options, (*see* Options in menus, selection of)
  - shortcuts for experienced users
    - 8.1.11.1.11 ..... 8-21
  - system ..... 8.3.9.1.5 ..... 8-70
    - 8.3.9.3 ..... 8-71
    - 8.3.9.4.1 ..... 8-71
    - application functions
      - 8.3.9.3.1 ..... 8-71
    - consistency ..... 8.3.9.3.3 ..... 8-71
    - menu bar ..... 8.3.9.3.2 ..... 8-71
    - mnemonics ..... 8.3.9.3.2 ..... 8-71
    - navigation aid ..... 8.3.9.3.5 ..... 8-71
  - types of options ..... 8.4.1.1.5 ..... 8-86
  - utilities ..... 8.3.9.4.2 ..... 8-72
  - when to use ..... 8.1.11.5.1 ..... 8-23
    - 8.1.11.6.1 ..... 8-24
  - window management, (*see* Window menu)
- Menu bar(s) ..... 8.1.11.4 ..... 8-23
  - 8.3.2.4.1 ..... 8-56
  - displaying a pull-down menu
    - 8.3.2.4.5 ..... 8-57
  - help availability ..... 8.3.12.1.1 ..... 8-80
  - in application windows
    - 8.3.10.1.1.c ..... 8-72
    - mnemonics ..... 8.3.10.1.4 ..... 8-73
    - names of options .. 8.3.10.1.4 ..... 8-73
    - options ..... 8.3.10.1.3 ..... 8-73
    - initial window size .... 8.3.11.2 ..... 8-79
    - leaving ..... 8.3.2.4.4 ..... 8-57
    - navigating to ..... 8.3.2.4.1 ..... 8-56
    - navigating within ..... 8.3.2.4.2 ..... 8-57
    - options as titles of pull-down menus
      - 8.3.7.3.1 ..... 8-66
    - selecting an option using its mnemonic
      - 8.3.7.2.4 ..... 8-66
      - 8.3.2.4.3 ..... 8-57
    - system window ..... 8.3.9.2.2 ..... 8-70
      - 8.3.9.2.3 ..... 8-71
      - 8.3.10.3.2 ..... 8-77
    - visibility of options .... 8.1.11.4.2 ..... 8-23
    - when to use ..... 8.1.11.4.1 ..... 8-23
  - Menus in windows ..... 8.3.7 ..... 8-65
    - applicable criteria and guidelines
      - 8.3.7.1.1 ..... 8-65
    - display of mnemonics and keyboard accelerators
      - 8.3.7.2.9 ..... 8-66
    - keyboard accelerators
      - 8.3.7.2.5 ..... 8-66
    - mnemonics ..... 8.3.7.2.1 ..... 8-65
      - 8.3.7.2.2 ..... 8-65
    - pull-down menus (*see* Menu(s), pull down)
    - selecting a menu bar option using its mnemonic
      - 8.3.7.2.4 ..... 8-66
    - selecting an option using its mnemonic
      - 8.3.7.2.3 ..... 8-66
    - scrolling (*see* Menu(s), scrolling)
    - wording of options .... 8.3.7.1.2 ..... 8-65
  - Menu selection interaction method
    - 8.1.11 ..... 8-19
    - and system response time
      - 8.1.11.1.5 ..... 8-20
    - appropriate use ..... 8.1.8.1.c ..... 8-17
      - 8.1.11 ..... 8-19
    - consistent with command language
      - 8.1.11.1.4 ..... 8-20
    - shortcuts for experienced users
      - 8.1.11.1.11 ..... 8-21
    - stacking selections .... 8.1.11.1.12 ..... 8-21
    - title(s) ..... 8.1.11.1.1 ..... 8-20
  - Mercury
    - use of ..... 12.6.5 ..... 12-16
  - Message(s) (*see also* Advisory messages(s); Data communication; Error Message(s); System messages; Windows, message)
    - addressing ..... 8.7.3 ..... 8-131
    - advisory ..... 11.3.1.5 ..... 11-5
    - confirming source of .. 11.5.4.3 ..... 11-11
    - editing address field .. 8.7.3.1.2 ..... 8-131
      - on-line directories . 8.7.3.3.1 ..... 8-132
      - on-line users ..... 8.7.3.1.3 ..... 8-131
      - prompting ..... 8.7.3.1.1 ..... 8-131
      - prompts for error correction
        - 8.7.3.4.2 ..... 8-132
      - substitute addresses
        - 8.7.3.3.2 ..... 8-132
      - user-defined distribution lists
        - 8.7.3.3.3 ..... 8-132
      - user-specified ..... 8.7.3.1.1 ..... 8-131
      - validation ..... 8.7.3.4.1 ..... 8-132
    - format (transmitted messages)
      - 8.7.2.3 ..... 8-131
      - 8.7.3.2 ..... 8-132

- Messages (continued)
- application-supplied
    - 8.7.2.3.2 ..... 8-131
    - header fields ..... 8.7.3.2.1 ..... 8-132
    - user-designed ..... 8.7.2.3.1 ..... 8-131
  - incoming
    - logging ..... 8.3.12.5.9 ..... 8-85
    - notification of arrival
      - 8.3.12.5.8 ..... 8-85
    - operations ..... 8.3.12.5.10 ..... 8-85
    - queuing ..... 8.3.12.5.9 ..... 8-85
  - notification
    - delayed or unsuccessful transmission
      - 8.3.12.5.6 ..... 8-84
    - incoming message arrival
      - 8.7.6.5 ..... 8-135
      - 8.3.12.5.8 ..... 8-85
    - incompatible format, incoming message
      - 8.7.6.4.2 ..... 8-135
    - noninterference with ongoing transactions
      - 8.7.6.5.2 ..... 8-135
    - outgoing message transmission and delivery
      - 8.7.4.2.5 ..... 8-133
    - transmission failure
      - 8.7.5.3.2 ..... 8-134
    - user control, incoming messages
      - 8.7.6.2.1 ..... 8-134
  - preparation ..... 8.7.2 ..... 8-131
    - applicable criteria and guidelines
      - 8.7.2.1.1 ..... 8-131
      - 8.7.2.2.2 ..... 8-131
    - content ..... 8.7.2.2.1 ..... 8-131
    - length ..... 8.7.2.1.2 ..... 8-131
    - printing ..... 8.7.2.1.1 ..... 8-131
    - procedures ..... 8.7.2.1.1 ..... 8-131
    - saving ..... 8.7.2.2.3 ..... 8-131
  - priority, notification of
    - 8.3.12.5.8 ..... 8-85
  - progressive "working" messages
    - 8.3.10.2.14 ..... 8-76
  - protection of transmitted
    - 11.5.4.1 ..... 11-10
  - reception ..... 8.7.6 ..... 8-134 - 8-135
    - annotating incoming messages
      - 8.7.6.3.5 ..... 8-135
    - applicable criteria and guidelines
      - 8.7.6.3.4 ..... 8-135
    - automatic queuing of incoming messages
      - 8.7.6.1.1 ..... 8-134
    - disposing of incoming messages
      - 8.7.6.2.4 ..... 8-134
    - incompatible format
      - 8.7.6.4.1 ..... 8-135
    - log of incoming messages
      - 8.7.6.1.2 ..... 8-134
    - naming incoming messages
      - 8.7.6.2.3 ..... 8-134
    - nondestructive review
      - 8.7.6.3.3 ..... 8-135
    - priority indication ..... 8.7.6.5.3 ..... 8-135
    - size indication ..... 8.7.6.3.6 ..... 8-135
    - user control ..... 8.7.6.2, 8.7.6.3 ..... 8-134
    - user review ..... 8.7.6.3 ..... 8-134
    - user-specified summaries
      - 8.7.6.3.1 ..... 8-134
  - replying, automatic addressing
    - 8.7.6.6.1 ..... 8-135
  - reviewing ..... 11.5.4.2 ..... 11-10
  - standard formats ..... 8.3.12.5.2 ..... 8-84
  - transmission ..... 8.7.4 ..... 8-132 - 8-133
    - appended information
      - 8.7.4.1.2 ..... 8-133
    - automatic queuing, outgoing messages
      - 8.7.4.1.1 ..... 8-132
    - cancellation of undelivered messages
      - 8.7.5.2.2 ..... 8-133
      - 8.7.4.2.6 ..... 8-133
    - content ..... 8.7.4.2.2 ..... 8-133
    - delivery notification
      - 8.7.4.2.5 ..... 8-133
    - failure ..... 8.7.5.3.2 ..... 8-134
    - in a query language
      - 8.1.14.4.3 ..... 8-33
    - log of transmitted messages
      - 8.7.5.1.1 ..... 8-133
  - queuing and subsequent attempts
    - upon unsuccessful attempt
      - 8.7.5.3.1 ..... 8-134
  - transmission notification
    - 8.7.4.2.5 ..... 8-133
  - transmission of ..... 11.5.4 ..... 11-10
  - user-assignable priority
    - 8.7.4.2.3 ..... 8-133
  - user initiation ..... 8.7.4.2.1 ..... 8-133
  - user-specified delivery
    - 8.7.4.2.4 ..... 8-133
  - user-specified feedback
    - 8.7.5.2.1 ..... 8-133
  - "working" ..... 8.1.3.3.2 ..... 8-7
- Message area
- help availability ..... 8.3.12.1.1 ..... 8-80
  - in application-level windows
    - 8.3.10.1.1.f ..... 8-73
  - in data displays ..... 8.5.1.14 ..... 8-103
  - in primary windows .. 8.3.10.1.9 ..... 8-74
  - log on error message .. 8.2.2.2.4 ..... 8-47
- Message windows (*see* Windows, message)
- Messages, error
- content ..... 8.1.5.2.7 ..... 8-12
  - for menus ..... 8.1.11.1.10 ..... 8-21
  - 8.4.1.1.7 ..... 8-86
  - help on ..... 8.6.1.5.13 ..... 8-129
  - incomplete form ..... 8.4.3.2.5 ..... 8-93
  - in windows ..... 8.1.1.26 ..... 8-4
  - log on ..... 8.2.2.2.4 ..... 8-47
  - multilevel ..... 8.1.5.2.3 ..... 8-12
  - multiple errors ..... 8.1.5.2.4 ..... 8-12
  - nondisruptive ..... 8.1.5.2.5 ..... 8-12
  - omitted entry ..... 8.4.3.8.3 ..... 8-97
  - probable error ..... 8.4.7.4 ..... 8-101
  - tone ..... 8.1.5.2.9 ..... 8-12
  - unacceptable entry in field
    - 8.4.3.8.2 ..... 8-97
  - windows ..... 8.3.10.2.7 ..... 8-76
  - working ..... 8.1.5.2.8 ..... 8-12
- Messages, routine ..... 8.1.3.6 ..... 8-9
- feedback ..... 8.1.3.6.1 ..... 8-9
  - user control of ..... 8.1.3.6.2 ..... 8-9
  - wording of ..... 8.1.3.6.3 ..... 8-9
- Messages, warning
- coding of ..... 8.1.5.2.6 ..... 8-12
- Metal grating ..... 9.3.3.3.1 ..... 9-11
- Metal tags
- for coding ..... 6.9.2.4.1 ..... 6-68

- Metric system (*see* International System of Units)
- Microphones
- dynamic range ..... 7.3.5.1.2 ..... 7-49
  - frequency range ..... 7.3.5.1.1 ..... 7-48
  - hands-free operation .. 7.3.5.3.2 ..... 7-50
  - noise cancelling ..... 7.3.5.1.3 ..... 7-49
  - noise shields ..... 7.3.5.1.5 ..... 7-49
- Military design standards
- limitations ..... foreword ..... i
- Miniature controls ..... 7.4.4.25 ..... 7-96
- dimensions ..... 7.4.4.25.1 ..... 7-96
  - displacement ..... 7.4.4.25.2 ..... 7-96
  - labeling ..... 7.4.4.25.4 ..... 7-96
  - orientation ..... 7.4.4.25.4 ..... 7-96
  - resistance ..... 7.4.4.25.2 ..... 7-96
  - separation ..... 7.4.4.25.1 ..... 7-96
  - when to use ..... 7.4.4.25.3 ..... 7-96
- Minimum force ..... 7.6.3.3 ..... 7-110
- Mittens (*see* Gloves)
- Mnemonic code(ing)
- case sensitivity ..... 8.3.7.2.7 ..... 8-66
  - consistency ..... 8.3.7.2.8 ..... 8-66
  - display of ..... 8.3.7.2.9 ..... 8-66
  - of application menu bar options
    - 8.3.10.1.4 ..... 8-73
  - of menu options 8.3.7.2.2 ..... 8-65
    - 8.1.11.9 ..... 8-26
    - 8.3.7.2.1 ..... 8-65
  - of pull-down menu options
    - 8.3.7.2.1 ..... 8-65
  - of system menu bar options
    - 8.3.9.3.2 ..... 8-71
  - selecting a menu bar option
    - 8.3.2.4.3 ..... 8-57
    - 8.3.7.2.5 ..... 8-66
  - selecting an option ..... 8.3.7.2.4 ..... 8-66
- Mobile support(s) ..... 6.9.1.6.8 ..... 6-64
- Modal (*see* Window mode, modal)
- Mode(s)
- analysis, human functions
    - 5.2.11 ..... 5-7
    - 5.3.3 ..... 5-10
  - compatibility, display control
    - 5.2.18 ..... 5-8
  - comprehensible displays
    - 5.2.18 ..... 5-8
  - control automation ..... 5.2.15 ..... 5-7
    - 5.2.16 ..... 5-8
  - cost of automation ..... 5.2.10 ..... 5-6
  - of a window, (*see* Window mode)
  - of operation
    - and human communications
      - 5.1.2.4 ..... 5-3
    - automation ..... 5.2.3 ..... 5-4
      - 5.2.13 ..... 5-7
    - C<sup>3</sup> ..... 5.4.3 ..... 5-14
    - Com subsystems .. 5.4.4 ..... 5-15
      - normal, degraded, backup emergency
        - 5.2.15 ..... 5-7
        - 5.2.10 ..... 5-6
        - 5.2.11 ..... 5-7
        - 5.2.16 ..... 5-8
      - process strategies .. 5.3.6 ..... 5-12
      - team interactions .. 5.6.1 ..... 5-18
    - insert, (*see* Insert mode)
    - replace, (*see* Replace mode)
    - supervisory control .... 5.3.3 ..... 5-10
- Model(s) (*see also* Analytic tools)
- C<sup>3</sup> architecture ..... 5.4.3 ..... 5-14
  - changes, old to new ... 5.4.3 ..... 5-14
  - computer based ..... 5.1.1.1 ..... 5-2
  - design issues ..... 5.4.3 ..... 5-14
  - expert judgement ..... 5.7.7 ..... 5-21
  - failure mode and effects
    - 5.7.7 ..... 5-21
    - 5.8.1 ..... 5-25
  - fault detection ..... 5.3.6 ..... 5-12
  - fault tree ..... 5.3.4 ..... 5-11
  - for design criteria ..... 14.1.6.2 ..... 14-15
  - human activity ..... 5.4.3 ..... 5-14
  - human interface ..... 5.4.3 ..... 5-13
  - human in-the-loop ..... 5.4.3 ..... 5-14
  - human probabilistic risk assessment
    - 5.8.1 ..... 5-25
    - 5.3.4 ..... 5-11
  - information flow ..... 5.4.3 ..... 5-14
  - interaction, systems, subsystems
    - 5.4.3 ..... 5-14
  - joint mobility in ..... 14.1.6.5 ..... 14-15
  - maintainability ..... 5.4.7 ..... 5-13
  - maintenance concept and strategies
    - 5.4.3 ..... 5-14
  - maintenance task ..... 5.8.1 ..... 5-16
  - of human physical characteristics
    - 14.1.6.1 ..... 14-15
  - probabilistic risk ..... 5.3.4 ..... 5-11
  - processing ..... 5.4.3 ..... 5-14
  - prototyping (rapid) ... 5.1.1.15 ..... 5-2
    - 5.4.3 ..... 5-14
  - reliability ..... 5.3.4 ..... 5-11
    - 5.8.1 ..... 5-25
    - low ..... 5.1.2.10 ..... 5-2
  - reliability block diagrams
    - 5.3.4 ..... 5-11
  - risk ..... 5.3.4 ..... 5-11
  - simulations ..... 5.1.1.1 ..... 5-2
  - systems ..... 5.3.7 ..... 5-13
  - use of ..... 14.1.6 ..... 14-14 - 14-15
  - using reach ..... 14.1.6.5 ..... 14-15
  - "what if" questions .... 5.4.3 ..... 5-14
  - work flow ..... 5.4.3 ..... 5-14
- Modeless (*see* Window mode, modeless)
- Modernization programs . 1 ..... 1-1
  - 5 ..... 5-1
- Modification of systems .. 1 ..... 1-1
  - 1.3 ..... 1-1
- Modified rhyme test ..... 7.3.5.6.1.b ..... 7-53
- "Modify"
- query language operation
    - 8.1.14.5.3.e ..... 8-34
- Modularization ..... 6.10.2.1 ..... 6-72
- methods ..... 6.10.2.2 ..... 6-72
  - of equipment ..... 6.1.1.1 ..... 6-2
  - order of preference .... 6.10.2.2.1 ..... 6-72
- Module(s) ..... 6.1.1 ..... 6-1
  - 6.1.2.7 ..... 6-3
  - accessible ..... 6.10.2.1.5 ..... 6-72
  - connections between .. 6.10.4.14 ..... 6-77
  - design ..... 6.10.2.2.a ..... 6-72
    - 6.10.4.7 ..... 6-77
  - disposal of ..... 6.1.1.1 ..... 6-2
  - dividing equipment into
    - 6.10.2.1.1 ..... 6-72

- Module(s) (continued)
- enclosed ..... 6.10.5.14 ..... 6-79
  - hazard protection ..... 6.10.3.3 ..... 6-75
  - identification ..... 6.10.5.13 ..... 6-79
  - interchangeable ..... 6.10.2.1.3 ..... 6-72
  - internal controls location
    - ..... 6.10.3.3.6 ..... 6-75
  - layout ..... 6.10.3.1.1 ..... 6-74
  - lubricated ..... 6.1.1.1 ..... 6-2
  - maintenance ..... 6.10.2.1.6 ..... 6-72
  - noninterchangeable .... 6.10.2.1.4 ..... 6-72
  - on hinges ..... 6.10.4.3 ..... 6-76
  - packaging of ..... 6.10 ..... 6-71 - 6-79
  - parts
    - grouping of ..... 6.10.3.2 ..... 6-75
    - heat-producing ..... 6.10.3.3.4 ..... 6-75
    - inspection ..... 6.10.3.1.7 ..... 6-74
    - location ..... 6.10.3.3.1 ..... 6-75
      - ..... 6.10.3.1.8 ..... 6-74
    - mounting ..... 6.10.3.1.2 ..... 6-74
      - ..... 6.10.4.8 - 6.10.4.10 .... 6-77
    - orientation ..... 6.10.3.1.3 ..... 6-74
    - positioning ..... 6.10.3.3.3 ..... 6-75
      - ..... 6.10.3.1.8 ..... 6-74
    - shielding ..... 6.10.3.3.1 ..... 6-75
      - ..... 6.10.3.3.4 ..... 6-75
    - with electrical potential
      - ..... 6.10.3.3.4 ..... 6-75
    - with emergency shutoff
      - ..... 6.10.3.1.10 ..... 6-75
    - with indicator lights
      - ..... 6.10.3.1.9 ..... 6-74
  - replacement ..... 6.10.4.11, 6.10.4.12 ... 6-77
  - sealed ..... 6.1.1.1 ..... 6-2
  - shielded ..... 6.10.5.14 ..... 6-79
  - single function ..... 6.10.2.1.2 ..... 6-72
  - stacked ..... 6.10.5.13 ..... 6-79
  - testing ..... 6.10.2.1.7 ..... 6-72
  - with case ..... 6.10.4.13 ..... 6-77
- Monitoring
- alarms and alerts ..... 5.7.6 ..... 5-20
  - automated subsystems
    - ..... 5.2.7 ..... 5-6
  - control of monitoring ..... 5.7.6 ..... 5-20
  - facilities, resources being monitored
    - ..... 5.7.1 ..... 5-19
    - ..... 5.7 ..... 5-19
    - ..... 5.7.2 ..... 5-19
  - graphical displays ..... 5.7.2 ..... 5-19
  - humans ..... 5.2.8 ..... 5-6
  - intentions ..... 5.2.8 ..... 5-6
    - of automated subsystems
      - ..... 5.2.6 ..... 5-5
    - of human inputs .... 5.2.4 ..... 5-6
  - remote monitoring system
    - ..... 5.7 ..... 5-19
  - status displays ..... 5.4.5 ..... 5-15
- Motion (*see* Joint motion, body motion)
- Mounting
- cables ..... 6.9.1.3 ..... 6-60
  - foldout ..... 6.10.4.1, 6.10.4.2 ..... 6-76
  - improper ..... 6.2.8.2 ..... 6-12
    - ..... 6.3.1.8 ..... 6-15
  - lines ..... 6.9.1.3 ..... 6-60
  - of equipment ..... 6.3 ..... 6-13 - 6-23
  - of internal components
    - ..... 6.10 ..... 6-71 - 6-79
- Mounting plate(s) ..... 6.9.1.5 ..... 6-62
- heat resistant ..... 6.9.2.2.5 ..... 6-68
- Mouse ..... 8.8.3.2 ..... 8-142
- dimensions of ..... 8.8.3.2.5 ..... 8-142
  - dynamic characteristics of
    - ..... 8.8.3.2.2 ..... 8-142
    - ..... 8.8.3.2.3 ..... 8-142
    - ..... 8.8.3.2.4 ..... 8-142
    - ..... 8.8.3.2.5 ..... 8-142
    - ..... 8.8.3.2.1 ..... 8-142
  - ease of movement ..... 8.8.3.2.3 ..... 8-142
  - lateral movement ..... 8.8.3.2.4 ..... 8-142
  - shape of ..... 8.8.3.2.5 ..... 8-142
  - use of ..... 8.8.3.2.1 ..... 8-142
- Move (pointing device button operation)
  - ..... 8.8.3.7.1.f ..... 8-146
- "Move"
- a help window ..... 8.3.12.1.3 ..... 8-80
  - a map display element
    - ..... 8.5.8.4.6.b ..... 8-123
  - a message window .... 8.3.10.2.1 ..... 8-74
  - data or objects
    - by dragging ..... 8.4.4.1 ..... 8-97
    - by temporary storage
      - ..... 8.4.4.2 ..... 8-98
      - ..... 8.4.2.2.3 ..... 8-90
  - editing operation ..... 8.4.2.2.3 ..... 8-90
  - graphic data displays . 8.5.5.3.13 ..... 8-109
  - in window ..... 8.3.2.4.2 ..... 8-57
  - moving a window using the keyboard
    - ..... 8.3.5.4 ..... 8-62
    - ..... 8.3.5.2 ..... 8-62
  - operation ..... 8.3.5.2 ..... 8-62
  - system window ..... 8.3.9.2.3 ..... 8-71
  - using window border . 8.3.2.3.1 ..... 8-56
- Movement
- disorders ..... 14.6.5 ..... 14-53
  - single joint ..... 14.3.3.2.1 ..... 14-31
  - trunk ..... 14.3.3.1.1 ..... 14-31
  - whole body ..... 14.3.3.1.2 ..... 14-31
    - ..... 14.4.1.c ..... 14-37
- Movement ratio (*see* Display-control movement ratio)
- Movement relationships (*see* Display-control movement relationships)
- Moving pointer scales (*see* Scales, moving pointer)
- Multipage
- data entry windows ... 8.3.12.2.3 ..... 8-81
  - displays ..... 8.5.1.19
    - 8.5.1.21 ..... 8-103
    - numbering of ..... 8.5.6.6.3 ..... 8-117
  - figures in documents .. 10.4.4.7.1 ..... 10-38
  - forms ..... 8.4.3.4.3 ..... 8-95
  - tables in displays ..... 8.4.5.7 ..... 8-98
  - tables in documents ... 10.4.5.7.1 ..... 10-40
- Multivariate data (*see* Data, multivariate)
- "Must" ..... 4.1.2 ..... 4-1
- Mutually exclusive options (*see* Options in menus, mutually exclusive)
- N**
- NAS (*see* National Airspace System)
- "Name"
- graphic displays and elements
    - ..... 8.5.8.4.6.d ..... 8-123
- National Airspace System
- 1 ..... 1-1
  - 5 ..... 5-1
  - air traffic control ..... 5 ..... 5-1
  - availability ..... 5.1 ..... 5-2
  - component ..... 5 ..... 5-1
  - goals ..... 5.1 ..... 5-2
  - prioritized goals ..... 5.1 ..... 5-1
  - prototyping ..... 5.1 ..... 5-1

- National Airspace System (continued)
- resource use ..... 5.1 ..... 5-2
  - safety ..... 5 ..... 5-2
  - simulation ..... 5.1 ..... 5-1
  - systems engineering ... 5.5 ..... 5-17
- Natural language interaction method
- 8.1.14 ..... 8-31 - 8-36
  - appropriate use ..... 8.1.8.1.g ..... 8-18
  - flexible query formulation
  - 8.1.14.1.9 ..... 8-31
- Navigation
- among open windows
  - 8.3.9.4.3.c ..... 8-72
  - from menu bar ..... 8.3.2.4.4 ..... 8-57
  - in data entry windows
  - 8.3.12.2.9 ..... 8-82
  - in forms (*see also* Form(s), navigation)
  - 8.4.3.5 ..... 8-95 - 8-96
  - in large diagrams ..... 8.5.5.11.1 ..... 8-114
  - in menu bar ..... 8.3.2.4.2 ..... 8-57
  - in pull-down menus ... 8.3.7.3.4 ..... 8-67
  - in scrolling menus .... 8.3.7.4.2 ..... 8-68
  - in tables
  - tab key ..... 8.4.5.5 ..... 8-98
  - pointing device .... 8.4.5.6 ..... 8-98
  - system overview ..... 8.3.9.3.5 ..... 8-71
  - to menu bar ..... 8.3.2.4.1 ..... 8-56
- NDI (*see* Non-developmental item)
- Network(s), connecting ... 11.3.1.10 ..... 11-7
- Network administrator .... 11.3.1.9 ..... 11-5
- "Next window"
- making a window active
  - 8.3.4.2.2 ..... 8-60
  - operation ..... 8.3.5.15 ..... 8-64
- Noise (*see also* Acoustic environment)
- 13.5 ..... 13-14 - 13-17
  - ambient level
  - auditory alarms .... 7.3.2.3.1 ..... 7-45
  - binaural headset use
  - 7.3.2.3.7 ..... 7-45
  - 7.3.5.2.5 ..... 7-50
  - 7.3.5.2.6 ..... 7-50
  - equipment areas .... 12.12.6 ..... 12-22
  - 13.5.2.8 ..... 13-17
  - extreme quiet ..... 12.12.3 ..... 12-22
  - 13.5.2.5 ..... 13-16
  - operational areas .. 12.12.5 ..... 12-22
  - 13.5.2.7 ..... 13-17
  - small offices ..... 12.12.4 ..... 12-22
  - 13.5.2.6 ..... 13-16
  - background ..... 13.5.2.1 ..... 13-16
  - criteria ..... 12.12.2 ..... 12-21
  - 13.5.2.4 ..... 13-16
  - design factors for ..... 13.1.a ..... 13-1
  - environmental ..... 4.2.2.b ..... 4-3
  - hazards ..... 12.12 ..... 12-21 - 12-23
  - levels ..... 12.12.1 ..... 12-21
  - exposure ..... 13.5.1.3 ..... 13-14
  - hazardous ..... 13.5.1 ..... 13-14
  - nonhazardous ..... 13.5.2 ..... 13-16
  - reducing ..... 13.5.1.1 ..... 13-14
  - monitoring ..... 13.5.1.4 ..... 13-15
  - workplace ..... 13.5.2.3 ..... 13-16
- Noise environment (*see* Acoustic environment)
- Noise hazards ..... 12.12.8 ..... 12-22
- 13.5.2.10 ..... 13-17
- Non-developmental items
- 1 ..... 1-1
  - 1.2 ..... 1-1
  - 1.3.2 ..... 1-2
  - 11.1.3 ..... 11-2
  - documentation for ..... 11.6.2 ..... 11-11
  - prior to commitment .. 1.3.2 ..... 1-2
  - "Nonflammable" (use of in user documentation)
  - 10.2.4.3.4 ..... 10-13
- Noninterchangeability
- of items ..... 6.1.3.3 ..... 6-4
  - of units of equipment . 6.3.2 ..... 6-15
- Nonskid
- material ..... 9.3.3.3.1 ..... 9-11
  - 12.2.1.7 ..... 12-2
  - 9.3.5.3.5 ..... 9-22
  - 9.3.9.5.6.4 ..... 9-28
  - surfaces ..... 9.3.2.3 ..... 9-10
  - 9.3.5.2.3 ..... 9-21
  - 9.3.5.6.3 ..... 9-28
  - providing ..... 9.3.1.3 ..... 9-8
- Nonslip grasp area ..... 6.2.6.2 ..... 6-11
- "No" push button
- in confirmation message windows
  - 8.3.10.2.10 ..... 8-76
  - "warning" ..... 8.3.10.2.11 ..... 8-76
- Normal mode (*see* Modes of operation)
- "Not" (data base query operation)
- 8.1.14.1.7 ..... 8-31
- Notes in user documentation
- 10.4.8 ..... 10-42 - 10-43
  - contents ..... 10.4.8.4 ..... 10-42
  - no procedural steps .... 10.4.8.6 ..... 10-43
  - precedence ..... 10.4.8.5 ..... 10-43
  - when to use ..... 10.4.8.1 ..... 10-42
- Notification (*see* Message(s), notification)
- Novice user(s)
- command languages ... 8.1.13.3 ..... 8-29
  - 8.1.13.12 ..... 8-30
  - documentation for ..... 10.1.1.2 ..... 10-2
  - interactive control systems
  - 8.1.1.2 ..... 8-1
  - needs for user guidance
  - 8.6.a ..... 8-125
  - of a query language .... 8.1.14.6.4
  - 8.1.14.6.6 ..... 8-36
- Number(s) (*see also* Numerals)
- 10.2.4.10 ..... 10-17
  - decimals ..... 10.2.4.10.3 ..... 10-17
  - fractions ..... 10.2.4.10.3 ..... 10-17
  - leading zeroes ..... 10.2.4.10.4 ..... 10-17
  - less than ten ..... 10.2.4.10.1 ..... 10-17
  - ten or greater ..... 10.2.4.10.1 ..... 10-17
  - trailing zeroes ..... 10.2.4.10.4 ..... 10-17
- Numbering
- decimal ..... 10.2.1.2.1 ..... 10-5
  - itemization within a paragraph
  - 10.2.1.2.2 ..... 10-5
  - number of levels ..... 10.2.1.2.3 ..... 10-5
  - of pages (*see* Page numbering)
  - of sections of a document
  - 10.2.1.2 ..... 10-5
- Numeral(s) (*see also* Numbers)
- Arabic ..... 10.2.4.10.2 ..... 10-17
  - roman ..... 10.2.4.10.2 ..... 10-17
  - when to spell out ..... 10.2.4.10.1 ..... 10-17



Numeric  
 keyboards ..... 7.4.4.9.2 ..... 7-76  
 key pads ..... 8.8.1.2 ..... 8-139  
 Numerical readout (for sliders)  
     8.1.15.5.2 ..... 8-39  
 Numeric data  
     justification  
         fields in forms ..... 8.4.3.7.3 ..... 8-96  
         tables in displays .. 8.4.5.4 ..... 8-98  
 Numeric scale(s) (*see Scales, numeric*)  
 Nut(s)  
     coding ..... 6.7.3.1 ..... 6-40  
     hexagonal ..... 6.7.3.1.4 ..... 6-41  
     knurled ..... 6.7.3.1.5 ..... 6-41  
     left-hand ..... 6.7.3.1.6 ..... 6-41  
     mounting ..... 6.7.3.1.8 ..... 6-41  
     wing ..... 6.7.3.1.5 ..... 6-41

**O**

Object(s)  
     eliciting name ..... 8.9.6.2.7 ..... 8-156  
     inserting ..... 7.6.1.1 ..... 7-103  
     location of ..... 8.9.6.2.8 ..... 8-156  
     of information ..... 11.4.1 ..... 11-9  
     size of ..... 8.9.6.2.8 ..... 8-156  
 Objectives of this HFD Guide  
     1.2 ..... 1-1  
 Occupational Safety and Health Administration  
     4.1.7 ..... 4-2  
     4.2.3 ..... 4-4  
     4.2.4 ..... 4-4  
     6.2.1 ..... 6-5  
     6.5.9 ..... 6-33  
     6.5.9.1 ..... 6-33  
     12.1 ..... 12-1  
 Occupational noise exposure  
     12.12.8 ..... 12-22  
     13.5.2.10 ..... 13-17  
 Office equipment  
     access by people with disabilities  
         8.9.1.1 ..... 8-151  
 Office rooms  
     ADA requirements .... 9.7.3 ..... 9-54  
 "OK" push button  
     in data entry windows  
         8.3.12.2.11 ..... 8-82  
     in error message windows  
         8.3.10.2.7 ..... 8-76  
     in help windows ..... 8.3.12.1.2 ..... 8-80  
     in information message windows  
         8.3.10.2.8 ..... 8-76  
     in on-line help displays  
         8.6.1.2.10 ..... 8-127  
     in request message windows  
         8.3.10.2.6 ..... 8-75  
     in warning message windows  
         8.3.10.2.11 ..... 8-76  
     in "working" message windows  
         8.3.10.2.13 ..... 8-76  
     to remove a help window  
         8.3.12.1.6 ..... 8-81  
 On-demand system check  
     6.12.3.3 ..... 6-83  
 One-finger recess handle . 6.2.5.3.1 ..... 6-10  
 On-line help  
     access and return ..... 8.6.1.2 ..... 8-127 - 8-128

application ..... 8.6.1.2.1 ..... 8-127  
 consistent access .. 8.6.1.2.5 ..... 8-127  
 easy access ..... 8.6.1.2.6 ..... 8-127  
 easy return ..... 8.6.1.2.9 ..... 8-127  
 "Help" command .. 8.6.1.2.7 ..... 8-127  
 reminder ..... 8.6.1.2.2 ..... 8-127  
 single action ..... 8.6.1.2.11 ..... 8-127  
 alternation between help and original display  
     8.6.1.2.8 ..... 8-127  
 applicable criteria and guidelines  
     8.6.1.1.1 ..... 8-126  
 availability ..... 8.6.1.1.2 ..... 8-126  
 browsing ..... 8.6.1.1.11 ..... 8-126  
 by passing for experienced users  
     8.6.1.1.9 ..... 8-126  
 consistent, distinctive format  
     8.6.1.1.5 ..... 8-126  
 content ..... 8.6.1.5 ..... 8-128 - 8-130  
     application information  
         8.6.1.5.7 ..... 8-129  
     available commands  
         8.6.1.5.8 ..... 8-129  
     basic information .. 8.6.1.5.1 ..... 8-128  
     command examples  
         8.6.1.5.9 ..... 8-129  
     command format ... 8.6.1.5.10 ..... 8-129  
     definitions ..... 8.6.1.5.12 ..... 8-129  
     error messages ..... 8.6.1.5.12 ..... 8-129  
     explanations ..... 8.6.1.5.1 ..... 8-128  
     function keys ..... 8.6.1.5.11 ..... 8-129  
     index ..... 8.6.1.5.14 ..... 8-130  
     memory aids ..... 8.6.1.5 ..... 8-128 - 8-130  
     prompts ..... 8.6.1.5.12 ..... 8-129  
     relevant information  
         8.6.1.5.2 ..... 8-129  
     shortcuts ..... 8.6.1.5.15 ..... 8-130  
     step-by-step instructions  
         8.6.1.5.1 ..... 8-128  
     system information  
         8.6.1.5.6 ..... 8-129  
 context-sensitive ..... 8.6.1.3 ..... 8-128  
     8.4.3.1.3 ..... 8-92  
     ambiguous context  
         8.6.1.3.2 ..... 8-128  
     context information in help display  
         8.6.1.3.3 ..... 8-128  
     historical ..... 8.6.1.3.5 ..... 8-128  
     in a query language  
         8.1.14.6.3 ..... 8-36  
     list of valid entries  
         8.6.1.3.4 ..... 8-128  
         task orientation .... 8.6.1.3.1 ..... 8-128  
     control options ..... 8.6.1.2.10 ..... 8-127  
     fields (in forms) ..... 8.4.3.1.3 ..... 8-92  
     finding help topics .... 8.6.1.5.16 ..... 8-130  
     guidance ..... 8.6.1.1.3 ..... 8-126  
     help on help ..... 8.6.1.5.4 ..... 8-129  
     highlighting ..... 8.6.1.1.7 ..... 8-126  
     location ..... 8.6.1.1.6 ..... 8-126  
     multilevel ..... 8.6.1.5.3 ..... 8-129  
         8.6.1.5.12 ..... 8-129  
         8.6.1.5.13 ..... 8-129  
     printing help information  
         8.6.1.1.10 ..... 8-126  
     prompts ..... 8.6.1.1.8 ..... 8-126  
     recognition of synonyms  
         8.6.1.2.13 ..... 8-128

- On-line help (continued)
- selected topics ..... 8.6.1.2.12 ..... 8-128
  - standard action ..... 8.6.1.2.4 ..... 8-127
  - titles ..... 8.6.1.5.5 ..... 8-129
  - to minimize memory load
    - 8.1.1.12 ..... 8-2
  - unavailability ..... 8.6.1.2.3 ..... 8-127
  - user annotations ..... 8.6.1.1.12 ..... 8-127
  - user-centered ..... 8.6.1.1.4 ..... 8-126
  - user-requested ..... 8.6.1.1.13 ..... 8-127
  - wording and style ..... 8.6.1.4 ..... 8-128
    - applicable criteria and guidelines
      - 8.6.1.4.1 ..... 8-128
    - appropriate to user
      - 8.6.1.4.3 ..... 8-128
    - wording ..... 8.6.1.4.2 ..... 8-128
- On-line information
- on-line procedures, job aids
    - 5.10.1 ..... 5-28
  - training and automation
    - 5.10.5 ..... 5-29
  - training costs ..... 5.10.3 ..... 5-28
  - training materials ..... 5.10.2 ..... 5-28
  - training simplicity ..... 5.10.3 ..... 5-28
- ON-OFF switches
- key-operated ..... 7.4.4.2.6 - 7.4.4.2.8 ..... 7-68
  - push-pull controls ..... 7.4.4.14.1 ..... 7-84
    - 7.4.4.14.6 ..... 7-86
  - rocker switches ..... 7.4.4.12.1 ..... 7-82
    - 7.4.4.12.3 ..... 7-82
    - 7.4.4.12.6 ..... 7-82
  - slide switches ..... 7.4.4.13.3 ..... 7-85
  - thumbwheels ..... 7.4.4.3.3 ..... 7-68
    - 7.4.4.6.5 ..... 7-75
  - toggle switches
    - orientation ..... 7.4.4.10.3 ..... 7-79
    - three-position ..... 7.4.4.10.3 ..... 7-79
- Opening(s)
- air-exhaust ..... 12.5.1.11 ..... 12-15
  - door with one hand ..... 6.5.5.3 ..... 6-30
  - large enough ..... 6.4.2.1 ..... 6-23
  - separate ..... 6.4.2.1 ..... 6-23
  - uncovered ..... 6.5.7.1 ..... 6-31
- Opening an iconized window
- 8.3.4.1.6 ..... 8-59
- Open Look™ style ..... 8.4.1.1.1 ..... 8-85
- Open window (*see* Window states, open)
- Operation(s)
- degraded ..... 6.1.2.2 ..... 6-3
  - FAA, not covered ..... foreword ..... ii
  - inadvertent ..... 8.9.2.8 ..... 8-152
  - in user-computer interactions
    - 8.2.2 ..... 8-46 - 8-48
  - noninterruption of ..... 6.1.2.1 ..... 6-3
  - one-handed ..... 14.1.4.4 ..... 14-10
  - scroll bars ..... 8.3.3.3.4, 8.3.3.3.5 ..... 8-58
  - searching, in a query language
    - 8.1.14.5.1 ..... 8-33
  - sliders ..... 8.1.15.5.3 ..... 8-40
  - two-handed ..... 14.1.4.4 ..... 14-10
  - window, (*see* Window operations)
- Operational modes in user-computer interaction
- 8.2.1.3.5 ..... 8-42
- Operational suitability, COTS and NDI
- 1.3.2 ..... 1-2
- Optical character reading devices
- 10.6.3.f ..... 10-67
- Optical character recognition
- 8.8.4.1.2.b ..... 8-147
- Optimum visual field ..... 7.2.1.6.8 ..... 7-11
- 7.2.1.6.9 ..... 7-12
- Option(s)
- transaction
    - at completion ..... 8.1.6.13 ..... 8-15
    - codes ..... 8.1.6.8 ..... 8-14
    - continue ..... 8.1.6.12 ..... 8-15
    - control ..... 8.1.6.4, 8.1.6.5 ..... 8-14
    - presentation ..... 8.1.6.7 ..... 8-14
    - wording ..... 8.1.6.6 ..... 8-14
- "Options"
- function key ..... 8.6.1.5.11 ..... 8-129
- Options in menus
- coding of ..... 8.1.11.9 ..... 8-26
  - consistency ..... 8.1.11.9.2, 8.1.11.9.5 ..... 8-26
  - conveyed meaning ..... 8.1.11.9.1 ..... 8-26
  - display of ..... 8.1.11.1.7 ..... 8-20
    - all options in scrolling menus
      - 8.3.7.2.9 ..... 8-66
    - codes ..... 8.1.11.9.5 ..... 8-26
    - keyboard accelerators
      - 8.3.7.2.9 ..... 8-66
    - mnemonics ..... 8.3.7.2.9 ..... 8-66
  - distinguishing marks
    - arrow ..... 8.3.7.3.5.c ..... 8-67
    - circle ..... 8.3.7.3.5.d ..... 8-67
    - ellipsis ..... 8.4.1.1.5 ..... 8-86
      - 8.3.7.3.5.a ..... 8-67
      - 8.4.1.1.5 ..... 8-86
    - triangle ..... 8.3.7.3.5.c ..... 8-67
  - formatting of ..... 8.1.11.2.1 ..... 8-21
    - 8.4.1.5.1 ..... 8-88
    - consistency ..... 8.1.11.2.2 ..... 8-21
    - 8.4.1.5.2 ..... 8-88
    - grouping of ..... 8.1.11.2.3 ..... 8-21
    - 8.4.1.5.3 ..... 8-88
    - numbering of ..... 8.1.11.2.6 ..... 8-22
    - ordering of ..... 8.1.11.2.4 ..... 8-21
    - 8.1.11.2.5 ..... 8-21
    - 8.4.1.5.4 ..... 8-88
    - 8.4.1.5.5 ..... 8-88
  - unavailable options
    - 8.1.11.1.8 ..... 8-20
    - 8.1.11.2.7 ..... 8-22
- highlighting most frequent options
- 8.4.1.1.3 ..... 8-86
- in pull-down menus ..... 8.3.7.3.5 ..... 8-67
- letter codes ..... 8.1.11.9.3 ..... 8-26
- mnemonic ..... 8.1.11.9 ..... 8-26
- numeric codes ..... 8.1.11.9.3, 8.1.11.9.4 ..... 8-26
- number displayed in scrolling menus
- 8.3.7.4.3 ..... 8-68
- number of ..... 8.1.11.1.6 ..... 8-20
- 8.3.7.3.6 ..... 8-67
- ordering, consistency ..... 8.1.11.1.3 ..... 8-20
- selection of ..... 8.1.11.7 ..... 8-24 - 8-25
- abbreviated entries
    - 8.1.11.7.5 ..... 8-25
  - by pointing ..... 8.1.11.7.6 ..... 8-25
  - 8.4.1.6.2 ..... 8-88
  - cursor position for selection by code entry
    - 8.1.11.7.3 ..... 8-25
    - 8.4.1.6.5 ..... 8-89

Options in menus (continued)

- cursor position for selection by pointing
  - 8.1.11.7.2 ..... 8-24
  - 8.4.1.6.4 ..... 8-88
- default option in a pull-down menu
  - 8.3.2.4.6 ..... 8-57
- equivalence of input devices
  - 8.4.1.6.1 ..... 8-88
  - 8.1.11.7.1 ..... 8-24
- feedback ..... 8.1.11.7.4 ..... 8-25
  - 8.4.1.6.6 ..... 8-89
- in pull-down menus
  - 8.3.7.3.4 ..... 8-67
- menu bar option using its mnemonic
  - 8.3.7.2.4 ..... 8-66
  - 8.3.2.4.3 ..... 8-57
- number of selections per menu
  - 8.4.1.6.7 ..... 8-89
  - 8.1.11.7.9 ..... 8-25
- size of selectable area
  - 8.1.11.7.7 ..... 8-25
- two-action activation
  - 8.4.1.6.3 ..... 8-88
  - 8.1.11.7.8 ..... 8-25
- using keyboard accelerators
  - 8.3.7.2.6 ..... 8-66
- using mnemonics .. 8.3.7.2.3 ..... 8-66
- titles of ..... 8.1.11.8.3 ..... 8-26
  - 8.1.11.8.4 ..... 8-26
- types of options
  - commands ..... 8.1.11.1.9 ..... 8-20
  - distinguishing marks
    - 8.1.11.1.9 ..... 8-20
  - names of menus .... 8.1.11.1.9 ..... 8-20
- unavailable options, display of
  - 8.4.1.1.6 ..... 8-86
  - 8.3.7.3.7 ..... 8-67
  - 8.1.11.1.8 ..... 8-20
  - 8.1.11.2.7 ..... 8-22
- window menu ..... 8.3.2.1.1 ..... 8-55
- wording of ..... 8.1.11.1.3 ..... 8-20
  - 8.3.7.1.2 ..... 8-65
  - 8.1.11.8.1, 8.1.11.8.2 .. 8-25

"Or" (data base query operation)

- 8.1.14.1.7 ..... 8-31

Orange

- dot matrix emitters .... 7.2.6.5 ..... 7-32
- in controls ..... 7.4.1.4.5 ..... 7-61
- use in CRT displays ... 7.2.4.2.4.a ..... 7-24

Orange-yellow

- in controls ..... 7.4.1.4.5 ..... 7-61

Ordering

- consistency ..... 8.1.11.1.3 ..... 8-20
- of pull-down menu options
  - 8.3.7.3.3 ..... 8-67
- of scrolling menu options
  - 8.3.7.4.2 ..... 8-68

Organizers, advance ..... 10.2.1.3 ..... 10-5 - 10-6

Orientation of access cover

- 6.5.3.2 ..... 6-30
- 8.4.2.3.6 ..... 8-91

Orphan protection ..... 8.4.2.3.6 ..... 8-91

Oscilloscope(s)

- in-tolerance meter reading
  - 6.15.2.1.4 ..... 6-97
- in-tolerance waveshape
  - 6.15.2.1.4 ..... 6-97

- preset circuits ..... 6.15.2.1.3 ..... 6-97
- OSF/MotifTM style ..... 8.4.1.1.1 ..... 8-85
- OSHA (*see* Occupational Safety and Health Administration)
- Output(s)
  - auditory ..... 8.9.6.1.2 ..... 8-154
  - devices ..... 8.9.5.1 ..... 8-153
  - minimized ..... 6.3.1.6 ..... 6-15
  - redundant visual ..... 8.9.6.1.1 ..... 8-154
- Outriggers for platforms
  - 12.2.2.2 ..... 12-3
- Overlapping objects, display of
  - 8.4.6.2.13 ..... 8-100
- Overlay(s)
  - color criteria and guidelines
    - 8.5.8.5.5 ..... 8-123
  - for test panels ..... 6.15.2.4.4 ..... 6-98
  - grid in map displays ... 8.5.8.3.20 ..... 8-122
  - in map displays ..... 8.5.8.5.4, 8.5.8.5.5 .. 8-123
  - in map windows ..... 8.3.12.4.5 ..... 8-83
    - editing ..... 8.3.12.4.8 ..... 8-84
  - in plotters ..... 7.2.9.3.5 ..... 7-41
  - print preview of ..... 8.5.8.4.10 ..... 8-123
  - situation displays as overlays
    - 8.5.8.1.5 ..... 8-118
  - tolerance limits on .... 6.15.2.4.5 ..... 6-98
  - tools for construction . 8.5.8.4.3 ..... 8-122
- Override, keyboard lockout
  - 8.1.2.9 ..... 8-6
- Override switch (*see* Interlock)

**P**

Pace, user control of ..... 8.1.1.21 ..... 8-3

Packaging

- circuit ..... 6.10.2.2.1 ..... 6-72
  - 6.10.2.2.3 ..... 6-73
- component ..... 6.10.2.2.1 ..... 6-72
  - 6.10.2.2.4 ..... 6-73
- logical flow ..... 6.10.2.2.1 ..... 6-72
  - 6.10.2.2.2 ..... 6-73
- of equipment ..... 6.3 ..... 6-13 - 6-23
- of interim components
  - 6.10 ..... 6-71 - 6-79

Padding ..... 14.6.3 ..... 14-53

Page(s)

- in displays
  - breaks ..... 8.4.2.3.6 ..... 8-91
  - formatting ..... 8.4.2.3.2 ..... 8-91
  - multipage forms .... 8.4.3.4.3 ..... 8-95
  - numbering ..... 8.4.2.3.7 ..... 8-93
  - orphan protection .. 8.4.2.3.6 ..... 8-93
  - widow protection .. 8.4.2.3.6 ..... 8-93
- in documents
  - basic size ..... 10.3.1.1.1 ..... 10-19
  - foldout ..... 10.3.2.8 ..... 10-25 - 10-26
  - left-handed ..... 10.3.2.5 ..... 10-23
  - margins ..... 10.3.2.1 ..... 10-20 - 10-21
  - odd sizes ..... 10.3.1.1.3 ..... 10-19
  - offset for binding .. 10.3.2.1.4 ..... 10-21
  - orientation ..... 10.3.1.2.1 ..... 10-20
  - right-handed ..... 10.3.2.5 ..... 10-23
  - size ..... 10.3.1.1 ..... 10-19
  - standard sizes ..... 10.3.1.1.2 ..... 10-19

Page numbering ..... 10.3.2.6 ..... 10-23

- appendixes ..... 10.3.2.6.4 ..... 10-24
  - 10.4.9.5 ..... 10-43

- Page numbering (continued)
- Arabic numerals ..... 10.3.2.6.1 ..... 10-24
  - body ..... 10.3.2.6.2 ..... 10-24
  - by major division ..... 10.3.2.6.2 ..... 10-24
  - default ..... 8.4.2.3.7 ..... 8-93
  - foldout pages ..... 10.3.2.8.7 ..... 10-26
  - front material ..... 10.3.2.6.3 ..... 10-24
  - left-handed pages ..... 10.3.2.5.2 ..... 10-23
  - location ..... 10.3.2.6.5 ..... 10-24
  - multipage displays ..... 8.5.1.2.1 ..... 8-103
  - ..... 8.5.6.6.3 ..... 8-117
  - right-handed pages ..... 10.3.2.5.2 ..... 10-23
  - sequential ..... 10.3.2.6 ..... 10-23
  - text in displays ..... 8.4.2.3.7 ..... 8-91
- Paging
- in continuous test ..... 8.5.6.3.2 ..... 8-116
  - in user-computer interaction
    - ..... 8.1.1.15 ..... 8-3
  - labeling ..... 8.2.1.6.3 ..... 8-44
  - partitioning ..... 8.2.1.6.2 ..... 8-44
  - static display ..... 8.2.1.6.1 ..... 8-44
  - multipage forms ..... 8.4.3.4.3 ..... 8-95
- Panels on consoles
- angles ..... 9.5.2.2 ..... 9-46
  - dimensions
    - without vision over
      - ..... 9.5.2.4 ..... 9-46
    - with vision over ..... 9.5.2.3 ..... 9-46
  - division ..... 9.5.3.1 ..... 9-47
  - stacked segments ..... 9.5.3 ..... 9-47
  - height of ..... 9.5.3.2 ..... 9-47
  - transilluminated labels for
    - ..... 7.2.2.4.1 ..... 7-18
  - viewing angle to ..... 9.5.2.5 ..... 9-46
  - width of ..... 9.5.2.1 ..... 9-46
- Panels on openings
- attaching ..... 12.4.4.9 ..... 12-12
  - removable ..... 6.5 ..... 6-28 - 6-34
  - riveted, unacceptable ..... 6.4.1.5 ..... 6-23
  - without removing ..... 6.4.2.3 ..... 6-24
- Panels, transilluminated .. 7.2.2.4 ..... 7-18
- brightness ..... 7.2.2.4.4 ..... 7-18
  - lamp replacement ..... 7.2.2.4.3 ..... 7-18
  - large, single, pictorial graphic panels
    - ..... 7.2.2.4.2 ..... 7-18
  - when to use ..... 7.2.2.4 ..... 7-18
- Panning ..... 8.5.6.4 ..... 8-116
- in map displays ..... 8.5.8.1.3 ..... 8-118
  - ..... 8.5.8.3.1 - 8.5.8.3.3 .. 8-120
  - scale integration ..... 8.5.6.4.4 ..... 8-116
  - when to use ..... 8.5.6.4.1 ..... 8-116
- Paper copy of displays .... 8.5.1.8 ..... 8-102
- Paradigm interaction in windows
- ..... 8.1.1.20 ..... 8-3
- Paragraph(s) ..... 10.2.2 ..... 10-7
- content ..... 10.2.2.1 ..... 10-7
  - indentation of first line
    - ..... 10.3.2.4.1 ..... 10-23
  - itemization within ..... 10.2.1.2.2 ..... 10-5
  - length ..... 10.2.2.4 ..... 10-7
  - spacing between ..... 8.2.3.6 ..... 8-49
  - titles ..... 10.2.1.1.2 ..... 10-4
- Parallax
- counters in visual displays
    - ..... 7.2.9.1.2 ..... 7-39
- location of visual display
    - ..... 7.1.2.12 ..... 7-3
    - ..... 7.2.1.6.3 ..... 7-10
  - multi-legend indicators
    - ..... 7.2.2.2.7 ..... 7-17
  - plane of pointer and scale marks
    - ..... 7.2.3.2.9 ..... 7-21
  - pointer mounting ..... 7.2.3.1.10 ..... 7-20
  - rotary selector switches
    - ..... 7.4.4.1.9 ..... 7-64
- Parameter setting by user (*see* Customization by user)
- Part(s)
- insertable ..... 8.9.2.6 ..... 8-152
  - labeling ..... 6.10.5.19 ..... 6-79
  - packaging of ..... 6.10 ..... 6-71 - 6-79
  - positioning of ..... 6.10.1.1 ..... 6-71
  - removable ..... 8.9.2.6 ..... 8-152
  - removing ..... 6.2.2.9 ..... 6-7
  - shielding ..... 6.15.1.2.1 ..... 6-94
  - symmetric, labeling .... 6.10.5.17 ..... 6-79
- Passageway(s)
- design of ..... 9.3 ..... 9-8 - 9-31
  - floors ..... 9.3.1.3 ..... 9-8
  - movement within ..... 9.3.2.7 ..... 9-10
- Passive voice ..... 10.2.3.6.1 ..... 10-8
- Password(s) ..... 11.3.2 ..... 11-7
- changing ..... 11.3.2.1 ..... 11-8
  - computer-generated .. 11.3.2 ..... 11-7
  - length of ..... 11.3.2 ..... 11-7
  - log on ..... 8.2.2.2.1 ..... 8-47
  - ..... 8.2.2.2.2 ..... 8-47
  - minimizing use ..... 11.3.1.8 ..... 11-5
  - nonechoing of ..... 8.2.2.2.3 ..... 8-47
  - prompts for ..... 11.3.1.4 ..... 11-5
  - ..... 11.3.1.9 ..... 11-5
  - protection of ..... 11.3.1.9 ..... 11-5
  - ..... 11.3.2 ..... 11-7
  - ..... 11.3.2.3 ..... 11-8
  - self-chosen ..... 11.3.2.1 ..... 11-8
  - source of ..... 11.3.2 ..... 11-7
- Patent issues (in user documentation)
- ..... 10.4.15 ..... 10-48
  - inclusion of patented information
    - ..... 10.4.15.2 ..... 10-48
  - prior consent to use patented information
    - ..... 10.4.15.2 ..... 10-48
- Pattern(s)
- graphic data ..... 8.4.6.2.7 ..... 8-100
  - rules for coding enclosed areas in displays
    - ..... 8.5.5.4.3 ..... 8-110
  - used in graphic data display
    - ..... 8.5.5.4.4 ..... 8-111
- Pattern coding
- scale indicators ..... 7.2.3.1.14 ..... 7-20
  - ..... 7.2.3.1.17 ..... 7-21
- "Pause"
- in a query language .... 8.1.14.4.4.f ..... 8-33
  - push button in "working" message windows
    - ..... 8.3.10.2.13 ..... 8-76
  - status indication ..... 8.1.4.7 ..... 8-10
  - user interrupt ..... 8.1.4.1, 8.1.4.6 ..... 8-9
- People with disabilities
- accommodating ..... 7.6 ..... 7-101 - 7-115
  - controls for ..... 7.6.3 ..... 7-109
  - displays for ..... 7.6.2 ..... 7-105
  - physical manipulations
    - ..... 7.6.1 ..... 7-103

- People with disabilities (continued)  
 safety for ..... 7.6.5 ..... 7-114  
 telecommunications for  
     7.6.4 ..... 7-114
- Percentile  
 designing for the  
   1<sup>st</sup> ..... 9.1.2 ..... 9-1  
     14.1.2.7 ..... 14-7  
   5<sup>th</sup> ..... 9.1.2 ..... 9-1  
     14.1.2.6 ..... 14-7  
   95<sup>th</sup> ..... 9.1.2 ..... 9-1  
     14.1.2.4 ..... 14-6  
   99<sup>th</sup> ..... 9.1.2 ..... 9-1  
     14.1.2.5 ..... 14-7  
   misuse of the 50<sup>th</sup> ..... 14.1.3.1 ..... 14-8  
   value ..... 14.1.3.2, 14.1.3.3 ..... 14-8
- Percentile statistic  
 determining values .... 14.1.5.1 ..... 14-13  
 selecting ..... 14.1.2.3 ..... 14-4
- Performance  
 capabilities ..... 9.1.1 ..... 9-1  
 environmental factors affecting  
   4.2.2 ..... 4-3  
 human ..... 4.2 ..... 4-2  
   4.3.6 ..... 4-5  
   5.2.12 ..... 5-7  
   13.1.2.b ..... 13-1  
 metrics ..... 5.2.12 ..... 5-7
- Permissible exposure limit (PEL)  
   13.5.1.1 ..... 13-14
- Permissible noise  
 exposure ..... E12.12.8 ..... 12-23
- Personal equipment (*see also* Protective equipment)  
 design compatibility .. 4.2.1.e ..... 4-3  
 designing ..... 14.1.2.9 ..... 14-7  
 protective ..... 13.5.1.2 ..... 13-14
- Personal life support ..... 4.3 ..... 4-4
- Personnel safety ..... 12 ..... 12-1 - 12-32
- Personnel skills ..... 4.3.1.c ..... 4-5
- Phases of development .... 1.3 ..... 1-2  
   4.3.2 ..... 4-5
- Phonetically balanced word intelligibility  
   7.3.5.6.1.a ..... 7-49
- Photographs (in user documentation)  
   10.4.4.4.2 ..... 10-36  
   10.4.4.4.3 ..... 10-36  
   10.4.4.5.3 ..... 10-37
- Phrases  
 consistent ..... 10.2.3.9.1 ..... 10-11  
 standard ..... 10.2.3.9 ..... 10-11
- Physical accommodation . 9.1.2 ..... 9-1
- Physical anthropometry ... 9.1.2 ..... 9-1
- Physical barriers, providing  
   12.2.1.4 ..... 12-1
- Physical comfort, designing for  
   14.6 ..... 14-52 - 14-53
- Physical dimensions ..... 9.1.1 ..... 9-1  
   workplaces ..... 9.1.2 ..... 9-1
- Physical hazard(s) ..... 12.5 ..... 12-13 - 12-16
- Physical manipulation  
 for people with disabilities  
   7.6.1 ..... 7-103  
 inserting objects ..... 7.6.1.1 ..... 7-103  
 opening doors and drawers  
   7.6.1.2 ..... 7-104  
 replacing parts ..... 7.6.1.3 ..... 7-104  
 understanding ..... 7.6.1.4 ..... 7-105
- Physical security ..... 11.2 ..... 11-3 - 11-4  
 features ..... 11.2.1 ..... 11-3
- Pictures ..... 8.5.5.10 ..... 8-114  
 appropriate use ..... 8.5.5.10 ..... 8-114  
 automated aids ..... 8.5.5.10.1 ..... 8-114
- Pie charts ..... 8.5.5.9 ..... 8-114  
 highlighting segments 8.5.5.9.4 ..... 8-114  
 labeling ..... 8.5.5.9.3 ..... 8-114  
 when not to use ..... 8.5.5.9.2 ..... 8-114
- Pig tailing, use of ..... 6.8.5.2.12 ..... 6-54
- Pin(s)  
 changing ..... 6.8.5.1.14 ..... 6-52  
 identification ..... 6.8.5.1.12 ..... 6-52  
 selection ..... 6.8.5.1.10 ..... 6-51
- Pin and hook (*see* Fastener, type of)
- Piping diagrams (in user documentation)  
   10.4.4.5.3 ..... 10-37
- Placard(s)  
 caution ..... 12.16.3 ..... 12-29  
 classification ..... 12.16.3 ..... 12-29  
 danger ..... 12.16.3 ..... 12-29  
 design of ..... 12.16.2 ..... 12-29  
 emergency ..... 12.16.3 ..... 12-29  
 fire ..... 12.16.3 ..... 12-29  
 hazard ..... 12.2.1.4 ..... 12-1  
 hazardous area ..... 12.16.17 ..... 12-32  
 instruction ..... 10 ..... 10-1  
 microwave ..... 12.16.8 ..... 12-31  
 "no-step" ..... 12.16.19 ..... 12-32  
 on portable test equipment  
   6.15.2.3.5 ..... 6-97  
 placement ..... 12.16.4 ..... 12-30  
 radio frequency (RF) . 12.16.8 ..... 12-31  
 safety  
   placement ..... 12.16.1 ..... 12-29  
   visibility of ..... 12.16.5 ..... 12-30  
   wording ..... 12.16.6 ..... 12-30  
     12.16.7 ..... 12-31  
 warning ..... 12.3.6 ..... 12-5  
 X radiation ..... 12.16.9 ..... 12-31
- Platform(s) ..... 9.3.3 ..... 9-10  
   12.2.2 ..... 12-3  
   12.2.2.1 ..... 12-3  
 design ..... 9.3.3.1.2, 9.3.3.1.3 ..... 9-11  
 floor surfaces ..... 9.3.3.3 ..... 9-11  
 nonskid materials on .. 12.2.1.7 ..... 12-2  
 on wheels ..... 9.3.3.2.2 ..... 9-11  
 portable ..... 9.3.3.2 ..... 9-11  
   collapsible ..... 9.3.3.2.2 ..... 9-11  
   lightweight ..... 9.3.3.2.1 ..... 9-11  
 raised ..... 9.3.3.1 ..... 9-11  
   dimensions ..... 9.3.3.1.1 ..... 9-10  
 safety features ..... 9.3.3.5.1 ..... 9-12  
   9.3.3.5.2 ..... 9-13  
 self-locking ..... 12.2.2.1 ..... 12-3  
 strength ..... 9.3.3.2.2 ..... 9-11  
 with high center of gravity  
   12.2.2.2 ..... 12-3
- Plot(ted)(ing)  
 aids, graphic data ..... 8.5.5.3.2 ..... 8-109  
 displaying values of data points  
   8.5.5.2.2 ..... 8-108  
 entered data ..... 8.4.6.3.1 ..... 8-101  
 stored data ..... 8.4.6.3.2 ..... 8-101  
   8.5.5.3.3 ..... 8-109
- Plotter(s), recorders, and graphic data hard copy  
 annotation ..... 7.2.9.3.7 ..... 7-41

- Plotter(s) (continued)
- contrast ..... 7.2.9.2.2 ..... 7-39
  - control, replenishment and service ..... 7.2.9.3.8 ..... 7-41
  - displays ..... 7.2.9.3 ..... 7-40
  - overlays ..... 7.2.9.3.5 ..... 7-41
  - smudging and smearing ..... 7.2.9.3.6 ..... 7-41
  - take-up provision ..... 7.2.9.3.4 ..... 7-40
  - visibility during creation ..... 7.2.9.3.2 ..... 7-40
  - when to use ..... 7.2.9.3.1 ..... 7-40
- Plug(s)
- adapter ..... 6.8.5.1.13 ..... 6-52
  - coding ..... 6.8.5.1.12 ..... 6-52
  - "cold" ..... 6.8.5.1.6 ..... 6-51
  - compatibility ..... 12.4.1.16 ..... 12-9
  - contacts ..... 6.8.5.1.4 ..... 6-51
  - labeling ..... 6.8.8.1 ..... 6-55
  - mounting on drawer ... 6.8.5.1.15 ..... 6-52
  - selection ..... 6.8.5.1.2 ..... 6-51
  - ..... 6.8.5.1.10 ..... 6-51
  - stored charges in ..... 6.8.5.1.7 ..... 6-51
- Plug-in connectors (*see also* Plugs)
- nonmatching ..... 6.8.5.1 ..... 6-51
  - preference ..... 6.8.2.2.2 ..... 6-48
  - selection ..... 6.8.5.1.1 ..... 6-51
  - use ..... 6.8.2.2.2 ..... 6-48
  - ..... 6.8.2.2.1 ..... 6-48
- Pointer (*see* Scale indicators, pointer)
- Pointer (of a pointing device)
- change to text cursor . 8.3.8.4 ..... 8-69
  - initial window placement ..... 8.3.11.3 ..... 8-79
  - movement ratio ..... 8.8.3.1.7 ..... 8-141
  - moving ..... 8.8.3.1.3 ..... 8-140
  - nondisappearance of .. 8.8.3.1.4 ..... 8-140
  - shape ..... 8.8.3.6 ..... 8-144
  - additional shapes .. 8.8.3.6.4 ..... 8-144
  - arrow ..... 8.8.3.6.1 ..... 8-144
  - during system startup ..... 8.3.9.1.4 ..... 8-70
  - general-purpose .... 8.8.3.6.1 ..... 8-144
  - single pointer ..... 8.8.3.1.2 ..... 8-140
- Pointing device(s) ..... 8.8.3 ..... 8-140
- appropriate type ..... 8.8.3.1.8 ..... 8-141
  - assignment of input focus ..... 8.3.4.3.3 ..... 8-60
  - buttons ..... 8.8.3.7 ..... 8-146
  - operations ..... 8.8.3.7.1 ..... 8-146
  - control of ..... 8.8.3.1.5 ..... 8-141
  - disabled ..... 8.1.1.25 ..... 8-4
  - disabled during system startup ..... 8.3.9.1.4 ..... 8-70
  - for graphic data ..... 8.4.6.1.1 ..... 8-99
  - functionality ..... 8.8.3.1.1 ..... 8-140
  - iconizing a window ... 8.3.5.9 ..... 8-63
  - joystick, (*see* Joystick)
  - keyboard equivalents . 8.8.1.8 ..... 8-139
  - light pen, (*see* Light pen)
  - manipulation of icons 8.1.15.1.7 ..... 8-37
  - mouse, (*see* Mouse)
  - movement ratio ..... 8.8.3.1.7 ..... 8-141
  - moving a window ..... 8.3.5.3 ..... 8-62
  - moving input focus to an object ..... 8.3.4.3.8 ..... 8-61
  - moving text cursor .... 8.4.2.4.3 ..... 8-91
  - ..... 8.3.8.3 ..... 8-69
  - moving the pointer .... 8.8.3.1.3 ..... 8-140
  - navigation in forms .... 8.4.3.5.7 ..... 8-96
  - navigation in tables ... 8.4.5.6 ..... 8-98
  - resizing a window ..... 8.6.5.5 ..... 8-98
  - restoring and icon ..... 8.3.5.11 ..... 8-99
  - selecting menu options ..... 8.1.11.7.6 ..... 8-25
  - selection of type ..... 8.8.3.1.8 ..... 8-141
  - single pointer ..... 8.8.3.1.2 ..... 8-141
  - size of selectable area ..... 8.1.11.7.8 ..... 8-25
  - stability of ..... 8.8.3.1.6 ..... 8-141
  - stylus and grid (*see* Stylus and grid)
  - two-action activation . 8.1.11.7.8 ..... 8-30
- Pointing functions ..... 8.9.2.3 ..... 8-152
- Polychlorinated biphenyl(s) (PCBs)
- disposing of ..... 12.9.6 ..... 12-19
  - inspecting ..... 12.9.6 ..... 12-19
  - marking ..... 12.9.6 ..... 12-19
- Population distribution, sizing determinations for ..... 14.1.2.9 ..... 14-9
- Pop-up menus (*see* Menus, pop-up)
- Portable test equipment .. 6.15.2.3 ..... 6-97
- calibration information on ..... 6.15.2.3.5 ..... 6-97
- connections ..... 6.15.2.3.2 ..... 6-97
- diagnostic aids ..... 6.12.3.9 ..... 6-83
- operating instructions 6.15.2.3.4 ..... 6-97
- storage space in ..... 6.15.2.3.3 ..... 6-97
- test panel on ..... 6.15.2.4.1 ..... 6-98
- when to use ..... 6.15.2.3.1 ..... 6-97
- Position(s) (*see also* Body positions, Eye positions, Working positions)
- avoiding awkward ..... 6.3 ..... 6-13 - 6-23
  - of access openings .... 6.4.2.2 ..... 6-24
  - of modules ..... 6.10.1.1 ..... 6-71
  - of parts ..... 6.10.1.1 ..... 6-71
  - seated ..... 14.2.3 ..... 14-15
  - standing ..... 14.2.3 ..... 14-15
- Position coding ..... 9.5.4.3 ..... 9-50
- Power
- failure ..... 13.4.7.2 ..... 13-13
  - removal ..... 12.4.1.7 ..... 12-8
  - tools ..... 12.2.1.4 ..... 12-1
- Power distribution diagrams (in user documentation) ..... 10.4.4.5.3 ..... 10-37
- Preferred speech interference level (PSIL) ..... 12.12.2 ..... 12-21
- ..... 13.5.2.4 ..... 13-16
- Press (a pointing device button) ..... 8.8.3.7.1.a ..... 8-146
- Press-to-talk
- button ..... 7.3.5.5.5 ..... 7-52
  - foot-operated switch .. 7.4.3.2 ..... 7-65
- Pressure gauge(s) ..... 6.14.2.8 ..... 6-90
- "Previous window"
- making a window active ..... 8.3.4.2.2 ..... 8-60
  - operation ..... 8.3.5.16 ..... 8-64
- Primary viewing area, displaying test in ..... 8.2.1.5.4 ..... 8-43
- Primary windows (*see* Windows, primary)
- Principles
- color selection (for displays) ..... 8.2.4.1.1 ..... 8-50

Principles (continued)  
 designing systems and equipment  
     4.4 ..... 4-1 - 4-2  
     display ..... 7.2.1 ..... 7-6 - 7-10  
     screen design ..... 8.2.1.1 ..... 8-40  
 "Print"  
     editing operation ..... 8.4.2.2.3 ..... 8-90  
     help information ..... 8.6.1.1.10 ..... 8-126  
     in text windows ..... 8.3.12.3.3 ..... 8-82  
     preview symbols and overlays  
         8.5.8.4.10 ..... 8-123  
     transmitted messages ..... 8.7.2.1.2 ..... 8-131  
 Printed circuit board(s)  
     design ..... 6.10.2.2.5.a ..... 6-73  
     feedback ..... 6.10.2.2.5.c ..... 6-73  
     identification ..... 6.10.2.2.5.d ..... 6-73  
     mounting ..... 6.10.2.2.5.a ..... 6-73  
     parts mounting ..... 6.10.3.1.5 ..... 6-74  
     plug-in ..... 6.10.2.2.5.b ..... 6-73  
 Printed circuit board illustrations (in user  
 documentation) ..... 10.4.4.5.3 ..... 10-30  
 Printed circuit switches ... 7.4.4.15 ..... 7-87  
     dimensions ..... 7.4.4.15.1 ..... 7-87  
     displacement ..... 7.4.4.15.3 ..... 7-87  
     resistance ..... 7.4.4.15.2 ..... 7-87  
     rocker switches ..... 7.4.4.15.3 ..... 7-87  
     separation ..... 7.4.4.15.4 ..... 7-87  
     shape ..... 7.4.4.15.5 ..... 7-87  
 Printers and alphanumeric hard copy displays  
     7.2.9.2 ..... 7-39  
     annotation ..... 7.2.9.2.5 ..... 7-40  
     characteristics and ratings  
         7.2.9.2 ..... 7-39  
     contrast ..... 7.2.9.2.2 ..... 7-39  
     controls, replenishment, and service  
         7.2.9.2.8 ..... 7-40  
     internal illumination .. 7.2.9.2.3 ..... 7-39  
     legibility ..... 7.2.9.2.6 ..... 7-40  
     legibility during printing  
         7.2.9.2.7 ..... 7-40  
 Priority  
     and queuing of incoming messages  
         8.7.6.1.1 ..... 8-134  
     indication for incoming messages  
         8.7.6.5.3 ..... 8-135  
     in telephone switching  
         7.3.5.5.7 ..... 7-52  
     of alarms ..... 7.2.1.5.4 ..... 7-9  
     of message ..... 8.3.12.5.8 ..... 8-85  
         8.7.4.2.3 ..... 8-133  
     of verbal warning signals  
         7.3.3.8 ..... 7-47  
     take-up provision ..... 7.2.9.2.4 ..... 7-39  
     user "filtering" of incoming messages  
         8.7.6.2.2 ..... 8-134  
     when to use ..... 7.2.9.2.1 ..... 7-39  
 Probabilistic risk assessment (see Models)  
 Procedural  
     guidance ..... 6.2.1.2 ..... 6-5  
     information, identification of  
         6.4.6.2 ..... 6-27  
 Proceduralized instructions (see Instructions,  
 proceduralized)  
 Procedures (see User control, procedures)  
 Process control  
     mental models ..... 5.3.6 ..... 5-12  
     supervisory control ... 5.3 ..... 5-9  
 Process flow ..... 9.5.4.3 ..... 9-50  
 Projected values ..... 8.5.5.6.5 ..... 8-113  
 Prompts  
     as on-line help ..... 8.6.1.1.8 ..... 8-126  
     default values ..... 8.5.6.2.2 ..... 8-115  
     error correction ..... 8.1.5.2.10 ..... 8-12  
     error correction, transmitted messages  
         8.7.3.4.2 ..... 8-132  
     help on ..... 8.6.1.5.12 ..... 8-129  
     input, consistent location  
         8.2.1.2.3 ..... 8-41  
     in user-computer interaction  
         8.1.3.1 ..... 8-6  
         control entries ..... 8.1.6.3 ..... 8-14  
         prompt contents ... 8.1.3.1.2 ..... 8-6  
         prompt duration ... 8.1.3.1.4 ..... 8-6  
         prompt location ... 8.1.3.1.3 ..... 8-6  
         user-selection of level of detail  
             8.1.3.1.5 ..... 8-7  
             when to use ..... 8.1.3.1.1 ..... 8-6  
     in windows ..... 8.1.1.24 ..... 8-4  
     log on ... 8.2.2.2.2 ..... 8-47  
     message address ..... 8.7.3.2.2 ..... 8-132  
     novice query language users  
         8.1.14.6.5 ..... 8-36  
     to exit application ..... 8.2.2.2.7 ..... 8-47  
     to save entries ..... 8.2.2.2.7 ..... 8-47  
         8.3.9.1.5 ..... 8-70  
 Pronouns (see also Referents)  
     10.2.4.6.1 ..... 10-14  
 Protanopic vision ..... 7.2.4.2.4 ..... 7-24  
 Protection  
     from chemicals ..... 12.9 ..... 12-18  
     health hazards ..... 4.2.3.b ..... 4-3  
     of equipment ..... 6.1.1.1.k ..... 6-2  
         6.2.1.1, 6.2.1.2 ..... 6-5  
     of maintainers ..... 6.1.1.1.k ..... 6-2  
     personal life support .. 4.2.3.b ..... 4-3  
     protective equipment .. 4.2.3.b ..... 4-3  
     Protective clothing ..... 13.1.2.a ..... 13-1  
     Protective equipment  
         personal ..... 13.5.1.2 ..... 13-14  
         providing ..... 12.4.1.2 ..... 12-7  
         selection of ..... 12.4.1.3 ..... 12-7  
         sizing allowances ..... 14.1.4.7 ..... 14-10  
             9.4.1 ..... 9-31  
 Prototypes  
     for evaluating controls  
         7.4.1.5.2 ..... 7-62  
 Prototyping  
     human interfaces ..... 5.5.3 ..... 5-17  
     rapid ..... 5.2.11 ..... 5-6  
         5.3.7 ..... 5-13  
     storyboarding ..... 5.6.3 ..... 5-19  
     systems engineering ... 5.2 ..... 5-10  
         5.6.3 ..... 5-19  
 Protuberances (see also Extensions)  
     avoiding ..... 6.2.4.1 ..... 6-8  
     removing ..... 6.2.4.2 ..... 6-8  
         6.3.1.7 ..... 6-15  
 "Proximity searching" (query language operation)  
     8.1.14.5.6.d ..... 8-35  
 PSIL (see Preferred Speech Interference Level)  
 Publication date (in user documentation), location  
     of ..... 10.4.16.1 ..... 10-48  
 Pull-down menus (see Menus, pull-down)

- Punctuation
- command stacks ..... 8.1.6.15 ..... 8-15
  - in a query language ... 8.1.14.3.4 ..... 8-32
  - in command languages
    - 8.1.13.15 ..... 8-30
  - sentences ..... 10.2.3.10.3 ..... 10-11
  - text in windows ..... 8.3.10.4.14 ..... 8-78
- Purpose of this HFD Guide
- 1.1 ..... 1-1
- Push buttons (in visual displays) (*see also* Button sets)
- 8.1.15.2 ..... 8-37
  - activation ..... 8.1.15.2.6 ..... 8-38
  - consistent appearance 8.1.15.2.1 ..... 8-37
  - defaults ..... 8.1.15.2.7 ..... 8-38
  - help availability ..... 8.3.12.1.1.c ..... 8-80
  - illuminated ..... 7.2.2.1.2 ..... 7-13
  - in data entry windows
    - 8.3.12.1.1.c ..... 8-80
  - in message windows .. 8.3.10.2.3 ..... 8-75
  - labels ..... 8.1.15.2.2 - 8.1.15.2.4 8-37
  - location and arrangement
    - 8.3.10.1.5 ..... 8-73
  - standard actions ..... 8.1.15.2.5 ..... 8-38
- Appendix C
- Push buttons (physical) ... 7.4.4.8 ..... 7-77
- inadvertent operation prevention
    - 7.4.4.8.6 ..... 7-78
  - positive feedback ..... 7.4.4.8.5 ..... 7-78
  - shape ..... 7.4.4.8.4 ..... 7-78
  - specifications ..... 7.4.4.8.1 ..... 7-77
  - when not to use ..... 7.4.4.8.3 ..... 7-78
  - when to use ..... 7.4.4.8.2 ..... 7-78
- Push-pull controls ..... 7.4.4.14 ..... 7-86
- detents ..... 7.4.4.14.4 ..... 7-85
  - direction of movement
    - 7.4.4.14.6 ..... 7-87
  - inadvertent operation .. 7.4.4.14.5 ..... 7-86
  - ON-OFF switches ..... 7.4.4.14.1 ..... 7-84
  - 7.4.4.14.6 ..... 7-87
  - resistance ..... 7.4.4.14.7 ..... 7-87
  - rotation ..... 7.4.4.14.3 ..... 7-85
  - snagging ..... 7.4.4.14.5 ..... 7-86
  - specifications ..... 7.4.4.14.1 ..... 7-84
  - when to use ..... 7.4.4.14.2 ..... 7-85
- Q**
- Qualified individuals with disabilities
- 7.6 ..... 7-115
- Query language ..... 8.1.14 ..... 8-31
- abbreviations ..... 8.1.14.5.4 ..... 8-34
  - assisting the user ..... 8.1.14.3.8 ..... 8-33
  - commands ..... 8.1.14.4.1 ..... 8-33
  - exceptional words ..... 8.1.14.3.6 ..... 8-33
  - general ..... 8.1.14.1 ..... 8-31
  - ease of use ..... 8.1.14.1.1 ..... 8-31
  - 8.1.14.4.4 ..... 8-33
  - error detection and correction
    - 8.1.14.1.10 ..... 8-32
  - format matched to user needs
    - 8.1.14.1.11 ..... 8-32
  - interactive, on-line use
    - 8.1.14.1.2 ..... 8-31
  - user assistance ..... 8.1.14.1.5 ..... 8-31
  - user preferences .... 8.1.14.1.12 ..... 8-32
  - importance ranking of search terms
    - 8.1.14.3.1 ..... 8-32
  - messages to user ..... 8.1.14.4.3 ..... 8-33
  - minimal user effort ... 8.1.14.4.2 ..... 8-33
  - operations
    - control ..... 8.1.14.5.1 ..... 8-33
    - other ..... 8.1.14.5.6 ..... 8-35
    - query formulation . 8.1.14.5.3 ..... 8-34
    - searching ..... 8.1.14.5.1 ..... 8-33
  - output appearance ..... 8.1.14.3.7 ..... 8-33
  - punctuation ..... 8.1.14.3.4 ..... 8-32
  - query screen design .. 8.1.14.2 ..... 8-32
  - applicable criteria and guidelines
    - 8.1.14.2.1 ..... 8-32
  - frequently used information
    - 8.1.14.2.3 ..... 8-32
  - relevant information only
    - 8.1.14.2.2 ..... 8-32
  - retention and redisplay of previous search
    - 8.1.14.3.2 ..... 8-32
  - searching ..... 8.1.14.5 ..... 8-33
  - search time feedback . 8.1.14.5.5 ..... 8-35
  - spelling variations ..... 8.1.14.3.3 ..... 8-32
  - usability ..... 8.1.14.4 ..... 8-33
  - user experience level . 8.1.14.6 ..... 8-35
  - accommodating different levels
    - 8.1.14.6.1 ..... 8-35
  - commands for experts
    - 8.1.14.6.7 ..... 8-36
  - context-sensitive help
    - 8.1.14.6.3 ..... 8-36
  - novice level 8.1.14.6.4
    - 8.1.14.6.6 ..... 8-36
  - user selection of level
    - 8.1.14.6.2 ..... 8-35
  - user requirements ..... 8.1.14.3 ..... 8-32
  - user-specified format of reports
    - 8.1.14.3.8 ..... 8-33
  - word roots ..... 8.1.14.3.5 ..... 8-33
- Query language interaction method
- 8.1.14 ..... 8-31
  - appropriate use ..... 8.1.8.1.f ..... 8-18
  - confirmation of large or slow retrievals
    - 8.1.14.1.6 ..... 8-31
  - flexible query formulation
    - 8.1.14.1.9 ..... 8-31
  - large-scale retrievals .. 8.1.14.1.6 ..... 8-31
  - logical combinations .. 8.1.14.1.7 ..... 8-31
  - reflects perceived data structure
    - 8.1.14.1.3 ..... 8-31
  - subsequent queries ..... 8.1.14.1.8 ..... 8-31
  - task orientation ..... 8.1.14.1.4 ..... 8-31
  - time-consuming retrievals
    - 8.1.14.1.6 ..... 8-31
- Question-answer interaction method
- 8.1.9 ..... 8-19
  - appropriate use ..... 8.1.8.1.a ..... 8-16
  - compatible sequence .. 8.1.9.3 ..... 8-19
  - one question at a time
    - 8.1.9.1 ..... 8-19
  - series of answers, display of
    - 8.1.9.2 ..... 8-19
- Queuing
- after failed transmission attempt
    - 8.7.5.3.2 ..... 8-134
  - incoming messages .... 8.3.12.5.9 ..... 8-85
  - 8.7.6.1.1 ..... 8-134
  - outgoing messages .... 8.7.4.1.1 ..... 8-132



Quick-acting connections ( <i>see</i> Quick fastening devices)	
Quick drench battery acid	12.9.3 ..... 12-19
Quick fastening devices ..	6.7.3.6 ..... 6-45
as cable termination ...	6.9.1.1.4 ..... 6-57
characteristics	
frequent access .....	6.7.3.6.1 ..... 6-46
no tools .....	6.7.3.6.2 ..... 6-46
simple operation ...	6.7.3.6.3 ..... 6-46
visual indication ...	6.7.3.6.4 ..... 6-46
clamps .....	6.9.1.5.3 ..... 6-62
for remote handling ...	6.2.9.2 ..... 6-13
operation .....	6.8.2.4 ..... 6-49
use .....	6.8.2.4.1 ..... 6-49
use of .....	6.9.2.1.5 ..... 6-67
.....	6.9.2.1.6 ..... 6-67
Quick reference guides ....	10 ..... 10-1
Quick-release clamps ( <i>see</i> Quick fastening devices)	
Quotations not for emphasis	10.3.3.7.7 ..... 10-30
QWERTY arrangement ...	7.4.4.9.3 ..... 7-78
<b>R</b>	
Race .....	14.2.2 ..... 14-15
Racks, mounting on .....	6.3.3
- 6.3.3.1.8 .....	6-15 - 6-16
6.3.3.3.3 .....	6-17
6.3.4.1.6 .....	6-18
Radiant energy	
far-infrared exposure .	12.14.4.1 ..... 12-27
.....	12.14.4.2 ..... 12-28
hazards .....	12.14 ..... 12-24 - 12-28
infrared	
removal of .....	12.14.3.3 ..... 12-27
microwave	
exposure to .....	12.14.5.1 ..... 12-28
near-infrared	
exposure .....	12.14.3.1 ..... 12-26
.....	12.14.3.2 ..... 12-27
near-ultraviolet	
exposure to .....	12.14.2.1, ..... 12-24
.....	12.14.2.2 ..... 12-24
ultraviolet	
exposure to .....	12.14.1 ..... 12-24
visible	
exposure to .....	12.14.3.1 ..... 12-26
.....	12.14.3.2 ..... 12-27
Radiation	
electromagnetic .....	12.8.4 ..... 12-18
hazards .....	12.8 ..... 12-18
ionizing .....	12.8 ..... 12-18
.....	12.8.3 ..... 12-18
microwave .....	12.8.4 ..... 12-18
non ionizing .....	12.8 ..... 12-18
.....	12.8.3 ..... 12-18
.....	12.8.4 ..... 12-18
OSHA .....	12.8.3 ..... 12-18
radio frequency .....	12.8.4 ..... 12-18
solar .....	13.1.c ..... 13-1
Radioactive materials, conformity	12.8.1 ..... 12-18
Radio frequency radiation ( <i>see</i> Radiation, radio frequency)	
Radio frequency voltages, guarding	12.4.1.14 ..... 12-8
Radium, use of .....	12.8.2 ..... 12-18
Railing, standard .....	9.3.3.4.2 ..... 9-12
.....	9.3.5.3.4 ..... 9-22
.....	E9.3.5.3.1 ..... 9-22
Ramp(s) .....	9.3.5 ..... 9-19
.....	9.3.5.3 ..... 9-21
.....	12.2.2 ..... 12-3
combined with stairs ..	9.3.5.3.3 ..... 9-22
construction materials	
.....	9.3.5.2.1 ..... 9-20
design requirements ...	9.3.5.2 ..... 9-20
dimensions for .....	9.3.5.3.1 ..... 9-21
emergency exit .....	9.3.4.4.3 ..... 9-16
for carts .....	9.3.5.3.2 ..... 9-21
for forklifts .....	9.3.5 ..... 9-19
for wheelchairs .....	9.3.5 ..... 9-19
handrails for .....	9.3.5.3.4 ..... 9-22
handrails on .....	9.3.5.2.5 ..... 9-21
illumination for .....	9.3.5.2.6 ..... 9-21
landings .....	9.3.5.3.6 ..... 9-23
nonskid materials on ..	9.3.5.2.3 ..... 9-21
.....	9.3.5.3.5 ..... 9-22
.....	12.2.1.7 ..... 12-2
providing .....	9.3.5.1.3.a ..... 9-21
selection of .....	9.3.5.1.1 ..... 9-19
strength of .....	9.3.5.2.2 ..... 9-20
warning labels on .....	9.3.5.2.4 ..... 9-21
when to use .....	9.3.5.1.2 ..... 9-20
Range	
of acceptable values, data entry	
.....	8.6.1.1.3 ..... 8-132
of motion	
for single joint .....	14.3.3.2 ..... 14-31 - 14-36
.....	14.3.3.2.1 ..... 14-31
for two joints .....	14.3.3.2.2 ..... 14-34
.....	14.3.3.2.3 ..... 14-34
Rapid prototyping ( <i>see</i> Prototyping)	
Reach .....	14.4 ..... 14-33 - 14-39
actions .....	14.4 ..... 14-36
arm, envelope .....	14.4.2 ..... 14-37
envelopes .....	14.4 ..... 14-36
building .....	14.1.4.4 ..... 14-10
data .....	14.4.4 ..... 14-38
for control tasks ...	14.4.3 ..... 14-38
reducing .....	14.4.4 ..... 14-38
three-dimensional .	14.4.4 ..... 14-38
using .....	14.1.4.4 ..... 14-10
fingertip grasp .....	14.4.4 ..... 14-38
fingertip touch .....	14.4.4 ..... 14-38
full hand grasp .....	14.4.4 ..... 14-38
limits .....	14.4 ..... 14-36
minimal .....	8.9.2.7 ..... 8-152
tasks .....	14.4.4 ..... 14-38
Readability ( <i>see</i> Writing level)	
.....	10.2.3.2.1 ..... 10-8
color in displays .....	8.2.4.1.3.d ..... 8-50
of documentation .....	10.6.3 ..... 10-63
of labels .....	6.3.5.2.1, 6.3.5.2.2 ..... 6-20
of lettering on controls	
.....	8.9.4.3 ..... 8-153
of lettering on keys ...	8.9.4.3 ..... 8-153
Reading grade level .....	10.2.3.2.1 ..... 10-8
Reading level (of document users)	
.....	10.1.1.1 ..... 10-2
"Read-Only"	
mode .....	11.3.1.9 ..... 11-5
status indication .....	11.5.1.4 ..... 11-10

- Real-time data ..... 8.5.7.1.2 ..... 8-117
- Reasonable accommodations (ADA)  
7.6 ..... 7-115
- Receptacles ..... 6.8.5.1 ..... 6-51  
  adapter ..... 6.8.5.1.13 ..... 6-52  
  coding ..... 6.8.8.1 ..... 6-55  
  compatibility ..... 12.4.1.16 ..... 12-9  
  identifying ..... 6.10.5.10 ..... 6-79  
  labeling ..... 6.8.8.1 ..... 6-55  
    12.16.13 ..... 12-31  
  preference ..... 6.8.5.1.1 ..... 6-51  
  selection ..... 6.8.5.1.2 ..... 6-51
- Recording  
  log on date and time .. 11.3.2.4 ..... 11-8  
  user access ..... 11.4.1 ..... 11-9
- Record keeping  
  automated ..... 11.5.3.1 ..... 11-10  
  informing users of .... 11.5.3.2 ..... 11-10
- Red  
  alphanumeric displays  
    7.2.7.4 ..... 7-33  
  coding in CRT displays  
    7.2.4.2.3 ..... 7-24  
  color combinations .... 8.2.4.1.23 ..... 8-53  
  comparisons ..... 8.2.4.1.23 ..... 8-53  
  dot matrix emitters .... 7.2.6.5 ..... 7-34  
  in controls ..... 7.4.1.4.5 ..... 7-61  
  in displays ..... 8.2.4.1.21 ..... 8-53  
  in scales ..... 7.2.3.1.16 ..... 7-20  
  key-operated switches  
    7.4.4.2.2 ..... 7-67  
  LED and segmented displays  
    7.2.6.6 ..... 7-32  
  reserved meaning in displays  
    8.5.4.5.1.a ..... 8-106  
  use in CRT displays ... 7.2.4.2.4 ..... 7-24
- Redundancy  
  among input devices .. 8.8.5.1 ..... 8-149  
  color coding in displays  
    8.5.4.5.3 ..... 8-106  
  color in displays ..... 8.2.4.1.1 ..... 8-50  
  in selecting menu options  
    8.1.11.7.1 ..... 8-24  
  of equipment ..... 6.1.2.2 ..... 6-3
- Reel(s) (for cables) ..... 6.9.1.6.6 ..... 6-63  
  6.9.1.6.7 ..... 6-63
- Reel carts ..... 6.9.1.6.6 ..... 6-63  
  6.9.1.6.7 ..... 6-63
- Reference guides ..... 10 ..... 10-1
- Reference material (in on-line help)  
8.6.1.1.3 ..... 8-126
- Reference points  
  basis of ..... 14.1.4.3 ..... 14-9  
  design ..... 14.4.2 ..... 14-37  
  establishing ..... 14.4.1 ..... 14-36  
  eye ..... 9.5.4.4 ..... 9-51  
    14.1.4.5 ..... 14-10  
  seat ..... 9.5.3.2 ..... 9-47  
    14.1.4.4 ..... 14-10  
    14.4.2 ..... 14-37  
  shoulder ..... 14.1.4.4 ..... 14-10
- Reference values (in graphic data display)  
8.5.5.2.1 ..... 8-108
- Reference zones, basis of  
14.1.4.3 ..... 14-9
- Referents (*see also* Pronouns)  
8.3.10.4.16 ..... 8-78
- Reflections  
  visual displays ..... 7.2.1.6.4 ..... 7-10  
  transilluminated displays  
    7.2.2.1.11 ..... 7-14
- Refresh rate  
  CRT displays ..... 7.2.4.1.1 ..... 7-23  
  joystick use ..... 7.4.4.17.2 ..... 7-90  
  visual displays ..... 7.2.1.1.10 ..... 7-7
- Regeneration of a display  
8.5.7 ..... 8-117
- Release (a pointing device button)  
8.8.3.7.1.b ..... 8-146
- Reliability (*see also* Models)  
  analyses ..... 5.3.4 ..... 5-11  
    5.7.7 ..... 5-21  
  block diagrams ..... 5.3.4 ..... 5-11  
  FAA services ..... 5 ..... 5-1  
  modernization ..... 5 ..... 5-1
- Remote control(s)  
  consistent control and display  
    5.8.2 ..... 5-25  
  function selection ..... 5.8.1 ..... 5-25  
  maintenance ..... 5.8 ..... 5-24 - 5-25  
  movement ..... 7.4.1.3.5 ..... 7-58  
  on-site maintenance .. 5.8.3 ..... 5-25  
  provided ..... 6.11.13 ..... 6-81
- Remote facility(ies)  
  monitoring ..... 11.2.2 ..... 11-4  
  security of ..... 11.2.3 ..... 11-4
- Remote handling ..... 6.2.9 ..... 6-13
- Remote switches  
  routing through ..... 6.9.1.3.13 ..... 6-61
- Removal  
  of components ..... 6.4.5.5 ..... 6-27  
  of equipment ..... 6.3.4.2.6 ..... 6-19
- "Remove" (a window)  
  map display elements . 8.5.8.4.6.c ..... 8-123
- "Rename"  
  in text windows ..... 8.3.12.3.3 ..... 8-82
- Replace mode  
  for text entry ..... 8.4.2.2.1 ..... 8-90  
  text cursor ..... 8.4.2.4.1 ..... 8-91  
    8.3.8.1 ..... 8-68
- Replacing equipment ..... 6.3.1.2 ..... 6-14
- "Report" (query language search operation)  
8.1.14.5.1.d ..... 8-34
- "Report format" (query language operation)  
8.1.14.5.6.b ..... 8-35
- Request message windows  
8.3.10.2.6 ..... 8-75
- Requirement(s)  
  closure ..... 6.5.1.2 ..... 6-28  
  maintenance ..... 11.3.1.1 ..... 11-5  
  operational ..... 11.3.1.1 ..... 11-5  
  structural ..... 6.5.1.2 ..... 6-28
- Rescue ..... 4.2.3.d ..... 4-4
- Research projects ..... 1.3 ..... 1-2
- Reserved areas  
  in data displays ..... 8.5.1.14 ..... 8-103  
  screen design ..... 8.2.1.4.2 ..... 8-42
- "Reset" push button in request message windows  
8.3.10.2.6 ..... 8-75
- Resistance, maximum, for controls  
14.5.2.1 ..... 14-43
- Resize  
  affects borders, not contents  
    8.3.11.4 ..... 8-79

- Resize (continued)  
   disallowed for message windows  
     8.3.10.2.2 ..... 8-74  
   graphic data displays . 8.5.5.3.12 ..... 8-109  
   help windows ..... 8.3.12.1.3 ..... 8-80  
   operation ..... 8.3.5.5 ..... 8-62  
   resizing a window using the keyboard  
     8.3.5.7 ..... 8-63  
   system window ..... 8.3.9.2.3 ..... 8-71  
   unavailable in icon menu  
     8.1.15.1.8 ..... 8-37  
   using window border . 8.3.2.3.1 ..... 8-56  
 Resolution elements  
   alphanumeric characters in CRT displays  
     7.2.4.6.5 ..... 7-27  
   graphic detail in CRT displays  
     7.2.4.7.3 ..... 7-27  
 Resource manager menu  
   completion of log on . 8.2.2.2.5 ..... 8-47  
   log off option ..... 8.2.2.2.6 ..... 8-47  
 Respirators, providing ..... 12.7.3 ..... 12-17  
 Response(s)  
   timed ..... 8.9.2.2 ..... 8-152  
   user ..... 8.9.2.2 ..... 8-152  
 Response time (*see* Display response time, System response time)  
 Rest(s) (*see* Stands)  
 "Restart"  
   in editing forms ..... 8.4.3.7.4 ..... 8-97  
   user interrupt ..... 8.1.4.1 ..... 8-9  
     8.1.4.8 ..... 8-10  
 "Restore"  
   in a query language .... 8.1.14.4.4.e ..... 8-33  
   map display elements 8.5.8.4.6.c ..... 8-123  
   operation ..... 8.3.5.1 ..... 8-62  
   window from icon .... 8.1.15.1.10 ..... 8-37  
 Rest provisions, design compatibility  
   4.2.1.d ..... 4-3  
 Restraint(s) (*see* Stop(s))  
 "Restrict" (query language search operation)  
   8.1.14.5.1.e ..... 8-34  
 Restrictions to adjustments  
   14.6.2 ..... 14-52  
 "Resume" push button  
   in a query language .... 8.1.14.4.4.f ..... 8-33  
   in "working" message windows  
     8.3.10.2.13 ..... 8-76  
 Retainer(s) (*see* Stops)  
 Retainer chains ..... 6.7.3.5.7 ..... 6-45  
   6.7.3.7.5 ..... 6-46  
 Retainer rings ..... 6.7.3.5.3 ..... 6-44  
 Retention ..... 10.2.1.3 ..... 10-5  
 Retina injury (*see* Injury, retina)  
 Retina scanning, as identification and authentication  
   11.3.3 ..... 11-8  
 "Retrieve"  
   in text windows ..... 8.3.12.3.3 ..... 8-82  
   map displays and elements  
     8.5.8.4.6.d ..... 8-123  
 Reverse, graphic data ..... 8.4.6.2.9 ..... 8-100  
 "Revert" (*see* "Restart")  
 "Review" (transaction operation)  
   8.1.4.9 ..... 8-10  
 Right-hand pages ..... 10.3.2.5 ..... 10-23  
   appendixes ..... 10.4.9.6 ..... 10-44  
   major divisions of document  
     10.3.2.5.1 ..... 10-23  
     odd-numbered ..... 10.3.2.5.2 ..... 10-23  
 Risk, probabilistic (*see* Models)  
 Risk analysis  
   human factors aspects of  
     11.1.2 ..... 11-2  
   protection derived from  
     11.2 ..... 11-3  
 Rivets ..... 6.7.3.5.6 ..... 6-44  
 Rocker switches ..... 7.4.4.12 ..... 7-81 - 7-83  
   8.9.5.3 ..... 8-154  
   accidental actuation prevention  
     7.4.4.12.4 ..... 7-82  
   ambient illumination .. 7.4.4.12.7 ..... 7-83  
   as printed circuit switches  
     7.4.4.15.3 ..... 7-87  
   internal illumination ... 7.4.4.12.7 ..... 7-83  
   labels ..... 7.4.4.12.8 ..... 7-84  
   orientation ..... 7.4.4.12.6 ..... 7-82  
   positive feedback ..... 7.4.4.12.5 ..... 7-82  
   specifications ..... 7.4.4.12.1 ..... 7-82  
   three-position rocker switches  
     7.4.4.12.3 ..... 7-82  
   when to use ..... 7.4.4.12.2 ..... 7-82  
 Rolling ball (*see* Ball controls)  
 Roman numerals ..... 10.2.4.10.2 ..... 10-17  
   in windows ..... 8.3.10.4.5 ..... 8-77  
 Rotary action controls  
   accidental actuation prevention  
     7.4.1.6.4.g ..... 7-59  
   combined with push-pull controls  
     7.4.4.14.3 ..... 7-85  
 Rotary selector switches .. 7.4.4.1 ..... 7-65  
   moving pointer ..... 7.4.4.1.2 ..... 7-65  
   number of positions .. 7.4.4.1.5 ..... 7-66  
   parallax ..... 7.4.4.1.9 ..... 7-67  
   placement of positions  
     7.4.4.1.6 ..... 7-66  
   reference line ..... 7.4.4.1.8 ..... 7-67  
   resistance ..... 7.4.4.1.7 ..... 7-67  
   shape ..... 7.4.4.1.4 ..... 7-65  
   shape coding ..... 7.4.4.1.4 ..... 7-65  
   specifications ..... 7.4.4.1.1 ..... 7-65  
   when to use ..... 7.4.4.1.2 ..... 7-65  
 "Rotate"  
   graphic data ..... 8.4.6.2.9 ..... 8-100  
   graphic data displays . 8.5.5.3.13 ..... 8-109  
 Rotation of diagrams ..... 8.5.5.11.3 ..... 8-114  
 Rubber gloves ..... 12.9.1 ..... 12-18  
 Ruggedness, design principle  
   4.1.9 ..... 4-2  
 Rules in this HFD Guide  
   1.4.1.1 ..... 1-3  
 "Run" (query language operation)  
   8.1.14.5.3.c ..... 8-34  
 Rung(s) ..... 9.3.5.6.3 ..... 9-28  
**S**  
 Safety  
   adverse environment .. 4.2.3.c ..... 4-3  
   contingency management  
     4.2.3.d ..... 4-3  
   COTS ..... 1.3.2 ..... 1-2  
   design principle ..... 4.1.7 ..... 4-2

- Safety (continued)
- electrical ..... 4.2.3.a ..... 4-3
    - 6.2.1.1 ..... 6-5
    - 9.2.1.4 ..... 9-4
    - 12.4.1.18 ..... 12-9
  - electromagnetic ..... 4.2.3.a ..... 4-3
  - emergency environment
    - 4.2.3.c ..... 4-3
  - emergency systems .... 4.2.3.d ..... 4-3
  - equipment-related ..... 12.3 ..... 12-4 - 12-5
  - escape ..... 4.2.3.d ..... 4-3
  - factors ..... 12.1.1 ..... 12-1
  - for people with disabilities
    - 7.6.5.1 ..... 7-114
    - audible warnings .. 7.6.5.1 ..... 7-114
    - automatic shutoff for hazard
      - 7.6.5.1 ..... 7-114
    - free from sharp edges/burrs
      - 7.6.5.1 ..... 7-114
    - nonslip surface .... 7.6.5.1 ..... 7-114
  - labels ..... 12.2.1.4 ..... 12-1
  - maximizing ..... 6.1.1.1.k ..... 6-2
  - mechanical ..... 4.2.3.a ..... 4-3
  - NAS goal ..... 5 ..... 5-1
    - 5.1.1.1 ..... 5-2
  - NDI ..... 1.3.2 ..... 1-2
  - objective of modernization
    - 5 ..... 5-1
  - of maintainers ..... 6.1.2.6 ..... 6-3
    - 6.2.1.1 ..... 6-5
  - pyrotechnic ..... 4.2.3.a ..... 4-3
  - radiological ..... 4.2.3.a ..... 4-3
  - rescue ..... 4.2.3.d ..... 4-3
  - survival ..... 4.2.3.d ..... 4-3
  - thermal ..... 4.2.3.a ..... 4-3
  - toxicological ..... 4.2.3.a ..... 4-3
  - visual ..... 4.2.3.a ..... 4-3
  - work space ..... 12.2 ..... 12-1 - 12-4
- Safety bars around platforms
  - 12.2.2.3 ..... 12-3
- Safety catches on connectors
  - 6.8.5.1.8 ..... 6-51
- Safety chains
  - around platforms ..... 12.2.2.3 ..... 12-3
  - use ..... 12.2.2.3 ..... 12-3
- Safety devices on ladders
  - 9.3.5.6.2 ..... 9-26
- Safety mesh installation .. 12.2.2.5 ..... 12-4
- Safety switches (*see* Switches, safety)
- Safety wire ..... 6.7.3.5.5 ..... 6-44
  - on controls ..... 7.4.1.6.4.d ..... 7-59
- Sample distribution, selecting
  - 14.1.2.2 ..... 14-4
- "Save"
- incoming message .... 8.3.12.5.10 ..... 8-85
  - incomplete form ..... 8.4.3.2.5 ..... 8-93
  - in data entry windows
    - 8.4.3.2.5 ..... 8-93
  - in text windows ..... 8.3.12.3.3 ..... 8-82
  - query language search operation
    - 8.1.14.5.1.f ..... 8-34
    - 8.1.14.5.3.f ..... 8-34
- Scaffolds ..... 9.3.3 ..... 9-10
  - 12.2.2 ..... 12-3
  - 12.2.2.1 ..... 12-3
- Scale(s) (*see also* Sliders)
- automatic production, graphic data display
    - 8.5.5.3.4 ..... 8-109
  - changes, graphic data displays
    - 8.5.5.3.12 ..... 8-109
  - conventions ..... 8.5.5.4.1 ..... 8-110
  - divisions, graduations
    - labeling ..... 8.5.5.4.12 ..... 8-112
    - number of ..... 8.5.5.4.11 ..... 8-112
      - 7.2.3.1.5 ..... 7-20
    - subdivision of ..... 8.5.5.4.11 ..... 8-112
      - 7.2.3.1.4 ..... 7-20
    - tick marks ..... 8.5.5.4.10 ..... 8-111
  - indication during zooming
    - 8.5.6.4.3 ..... 8-116
  - in graphic data displays
    - 8.5.5.3 ..... 8-108
  - integration during panning and zooming
    - 8.5.6.4.4 ..... 8-116
  - linear ..... 7.2.3.1.3 ..... 7-20
    - 8.5.5.4.8 ..... 8-111
  - logarithmic ..... 8.5.5.4.8 ..... 8-111
  - numeric ..... 8.5.5.4.12 ..... 8-112
    - 7.2.3.1.6 ..... 7-20
  - one per axis ..... 8.5.5.4.9 ..... 8-111
  - pointer (*see* Scale indicators, pointer)
    - tick marks ..... 8.5.5.4.10 ..... 8-111
    - zero as starting point .. 7.2.3.1.7 ..... 7-20
- Scale indicators ..... 7.2.3 ..... 7-18 - 7-23
- (*see also* Scales, fixed pointer; Scales, moving pointer)
- appropriate information
    - 7.2.3.1.2 ..... 7-19
  - calibration information
    - 7.2.3.1.13 ..... 7-20
  - characteristics of moving and fixed indicators
    - 7.2.3.1 ..... 7-18
  - color coding ..... 7.2.3.1.14
    - 7.2.3.1.16 ..... 7-20
  - luminance contrast .... 7.2.3.1.12 ..... 7-20
  - pattern coding ..... 7.2.3.1.14, 7.2.3.1.15,
    - 7.2.3.1.17 ..... 7-20
  - pointer
    - color ..... 7.2.3.1.11 ..... 7-20
    - length ..... 7.2.3.1.8 ..... 7-20
    - mounting ..... 7.2.3.1.10 ..... 7-20
    - tip ..... 7.2.3.1.9 ..... 7-20
    - use linear scales ..... 7.2.3.1.3 ..... 7-19
    - use moving, not fixed indicator
      - 7.2.3.1.1 ..... 7-19
- Scales, fixed pointer ..... 7.2.3.3 ..... 7-22 - 7-23
- alignment of pointer or reference line
    - 7.2.3.3.4 ..... 7-22
  - characteristics ..... 7.2.3.1 ..... 7-18
  - composite displays .... 7.2.3.3.8 ..... 7-22
  - moving tape scale .... 7.2.3.3.7 ..... 7-22
  - numerical progression
    - 7.2.3.3.2 ..... 7-22
- Scales, fixed pointer
- orientation ..... 7.2.3.3.3 ..... 7-22
  - setting ..... 7.2.3.3.5 ..... 7-22
  - tracking ..... 7.2.3.3.6 ..... 7-22
  - when to use ..... 7.2.3.1.1 ..... 7-19
    - 7.2.3.3.1 ..... 7-22
- Scales, moving pointer .... 7.2.3.2 ..... 7-20
- break in curved scales
    - 7.2.3.2.6 ..... 7-21

- Scales, moving pointer (continued)
- characteristics ..... 7.2.3.1 ..... 7-18
  - direction of increase .. 7.2.3.2.3 ..... 7-21
  - labeling marks on circular scales
    - 7.2.3.2.9 ..... 7-21
  - number of pointers .... 7.2.3.2.7 ..... 7-21
  - number placement ..... 7.2.3.2.11 ..... 7-22
  - numerical progression
    - 7.2.3.2.1 ..... 7-20
  - orientation ..... 7.2.3.2.2 ..... 7-21
  - pointer alignment
    - circular scales ..... 7.2.3.2.5 ..... 7-21
    - noncircular scales . 7.2.3.2.8 ..... 7-21
  - pointer placement ..... 7.2.3.2.10 ..... 7-21
  - when to use ..... 7.2.3.1.1 ..... 7-19
  - zero position ..... 7.2.3.2.4 ..... 7-21
- Scaling
- graphic data display ... 8.5.5.3.4 ..... 8-109
  - graphic objects ..... 8.4.6.2.11 ..... 8-100
- Scatterplots ..... 8.5.5.8 ..... 8-113
- highlighting points .... 8.5.5.8.2 ..... 8-113
  - when to use ..... 8.5.5.8.1 ..... 8-113
- Schematic diagrams (in user documentation)
- 10.4.4.5.3 ..... 10-37
- Scope of this HFDG ..... 1.3 ..... 1-1
- Screen(s) (on equipment) 9.3.3.4 ..... 9-11
- 9.3.5.4.3 ..... 9-23
  - flashing cursors on .... 8.9.7.1 ..... 8-156
  - guard ..... 9.3.3.4.3 ..... 9-12
- Screen design ..... 8.2 ..... 8-40 - 8-54
- consistency ..... 8.2.1.2 ..... 8-41
  - displaying text ..... 8.2.1.5 ..... 8-43
  - format ..... 8.2.1.4 ..... 8-42
  - layout ..... 8.2.1.4.3 ..... 8-43
  - paging ..... 8.2.1.6.2 ..... 8-44
  - principles ..... 8.2.1.1 ..... 8-40
  - density of display . 8.2.1.1.5 ..... 8-40
  - 8.2.1.1.6 ..... 8-41
  - 8.2.1.1.7 ..... 8-41
  - logical grouping ... 8.2.1.1.2 ..... 8-40
  - minimal movement
    - 8.2.1.1.3 ..... 8-40
  - simplicity ..... 8.2.1.1.1 ..... 8-40
  - usability ..... 8.2.1.1.8 ..... 8-41
  - what to display .... 8.2.1.1.4 ..... 8-40
  - reserved areas ..... 8.2.1.4.2 ..... 8-42
  - scrolling ..... 8.2.1.6 ..... 8-44
- Screen saver ..... 8.2.2.1.1 ..... 8-46
- 8.3.9.4.3.a ..... 8-72
  - 11.3.1.9 ..... 11-5
- Screw(s) ..... 6.7.3.2 ..... 6-41
- combination-head ..... 6.7.3.3.2 ..... 6-42
  - countersunk ..... 6.7.3.2.6 ..... 6-42
  - 12.5.1.3 ..... 12-13
  - fine threads ..... 6.7.3.2.5 ..... 6-42
  - flat-head ..... 6.7.3.2.7 ..... 6-42
  - for thin panels ..... 6.7.3.2.6 ..... 6-42
  - heads ..... 6.7.3.3 ..... 6-42
  - minimizing sizes ..... 6.7.3.2.8 ..... 6-42
  - selection ..... 6.7.3.6.5 ..... 6-46
  - self-tapping ..... 6.7.3.2.8 ..... 6-42
  - slot depth ..... 6.7.3.2.2 ..... 6-41
  - turns to tighten ..... 6.7.3.2.1 ..... 6-41
  - when to use ..... 6.7.3.2.3 ..... 6-41
- Screwdriver guide(s) ..... 6.11.10 ..... 6-81
- 6.11.11 ..... 6-81
  - 6.7.3.2.4 ..... 6-42
- Scroll bars ..... 8.3.3.3 ..... 8-58
- components ..... 8.3.3.3.2 ..... 8-58
  - current display symbol
    - 8.3.3.3.3 ..... 8-58
  - in control windows .... 8.3.10.1.11 ..... 8-74
  - in data entry windows
    - 8.3.12.2.1 ..... 8-81
  - in scrolling menus ..... 8.3.7.4.1 ..... 8-68
  - in text windows ..... 8.3.12.3.2 ..... 8-82
  - recommended operations
    - 8.3.3.3.5 ..... 8-58
  - required operations ... 8.3.3.3.4 ..... 8-58
- Scrolling
- in continuous text ..... 8.5.6.3.2 ..... 8-116
  - in grouped information
    - 8.5.6.3.3 ..... 8-116
  - in user-computer interaction
    - 8.1.1.15 ..... 8-3
  - large tables ..... 8.4.5.7 ..... 8-98
  - 8.4.5.8 ..... 8-99
  - menus (*see* Menu, scrolling)
    - static display ..... 8.2.1.6.1 ..... 8-44
- Scrolling fields ..... 8.3.3.2.3 ..... 8-58
- Scrolling lists (*see* Menu, scrollable)
- Seals ..... 6.8.7 ..... 6-54
- airtight when disconnected
    - 6.8.6 ..... 6-54
    - identifiable ..... 6.8.7.3 ..... 6-55
    - in connectors ..... 6.9.2.1.3 ..... 6-66
    - 6.9.2.1.4 ..... 6-66
    - life expectancy ..... 6.8.7.4 ..... 6-55
    - non-protruding ..... 6.8.7.8 ..... 6-55
    - 6.9.2.1.4 ..... 6-66
    - replaceable ..... 6.8.7.1 ..... 6-54
    - 6.8.7.2 ..... 6-55
    - shrinking ..... 6.8.7.6 ..... 6-55
    - visibility ..... 6.9.2.1.3 ..... 6-66
- Second person sentences . 10.2.3.7.1 ..... 10-8
- Search and replace ..... 8.4.2.2.5 ..... 8-90
- in text windows ..... 8.3.12.3.5 ..... 8-83
- Search
- character string ..... 8.4.2.2.5 ..... 8-90
  - in scrolling menus ..... 8.3.7.4.5 ..... 8-68
  - in text in windows ..... 8.3.10.4.18 ..... 8-79
- "Search history" (query language search operation)
- 8.1.14.5.1.g ..... 8-34
- "Search index" (query language operation)
- 8.1.14.5.6.c ..... 8-35
- Search, wild card characters
- 8.6.9.4.18 ..... 8-79
- Seat(s) (*see also* Seat reference point)
- adjustable ..... 9.5.4.5 ..... 9-51
  - back angle ..... 14.4.4 ..... 14-41
  - compatibility ..... 9.4.4.2 ..... 9-40
  - cushioning ..... 9.4.4.6 ..... 9-42
  - design ..... 9.4.4.4 ..... 9-40
  - dimensions ..... 9.4.4.4 ..... 9-40
  - form fitting ..... 14.6.2 ..... 14-52
  - selection ..... 9.4.4.4 ..... 9-40
  - temporary ..... 9.5.4.5 ..... 9-51
  - with armrests ..... 9.4.4.7 ..... 9-42
  - with rollers ..... 9.4.4.3 ..... 9-40
  - with swivel ..... 9.4.4.3 ..... 9-40
  - workplace ..... 9.4.4.1 ..... 9-40
- Seated work ..... 9.4.4 ..... 9-39
- Secondary windows (*see* Windows, secondary)
- Security architecture ..... 11.1.1 ..... 11-1

- Security breach ..... 11.2.4 ..... 11-4
- Security incident(s) ..... 11.1.8 ..... 11-3
- reporting ..... 11.2.2 ..... 11-4
- tracking ..... 11.1.9 ..... 11-3
- Security level(s)
- changes in ..... 11.5.2.1 ..... 11-10
- of information ..... 11.3.1.14 ..... 11-7
- Security measures, nonautomated
- 11.1.6 ..... 11-3
- Security personnel
- notification of ..... 11.1.8 ..... 11-3
- training of ..... 11.7.2 ..... 11-11
- Security planning ..... 11.1.2 ..... 11-2
- Security safeguard(s) ..... 11 ..... 11-1
- allowing selective audits
- 11.4.4 ..... 11-9
- attempts to defeat ..... 11.1.8 ..... 11-3
- automatic record keeping
- 11.5.3.1 ..... 11-10
- certification of ..... 11.1.2 ..... 11-2
- design ..... 11.1.1 ..... 11-1
- documentation ..... 11.6 ..... 11-11
- failure of ..... 11.1.7 ..... 11-3
- human interface of ..... 11.1.3 ..... 11-2
- limiting ..... 11.3.1.6 ..... 11-5
- "locking out" terminal
- 11.3.1.7 ..... 11-5
- log on attempts ..... 11.3.1.9 ..... 11-5
- log on errors ..... 11.3.1.9 ..... 11-5
- minimizing unauthorized changes
- 11.3.1.8 ..... 11-5
- 11.5.1.2 ..... 11-9
- modules ..... 11.6.2 ..... 11-11
- operation ..... 11.1.1 ..... 11-1
- protecting
- audit data ..... 11.5.1.1 ..... 11-9
- system integrity ..... 11.5.1.1 ..... 11-9
- protection ..... 11.1.1 ..... 11-1
- transparent to user ..... 11.3.1.12 ..... 11-7
- user documentation for
- 11.6.1 ..... 11-11
- 11.6.2 ..... 11-11
- Segmented displays (*see* Dot matrix and segmented displays)
- Seizure(s)
- flashing-induced ..... 8.9.7.1 ..... 8-156
- Select(ing) a menu option (*see* Options in menus, selection of)
- "Select"
- a map display element
- 8.5.8.4.6.a ..... 8-123
- in a query language ..... 8.1.14.5.1.a ..... 8-33
- 8.1.14.5.3.a ..... 8-34
- 6.15.1.1.3 ..... 6-94
- Selector switches, use of ..... 6.15.1.1.3 ..... 6-94
- Self-locking device ..... 9.3.3.5.2 ..... 9-13
- Self lubrication ..... 6.1.1.1 ..... 6-2
- "Send" push button for message transmission
- 8.3.12.5.5 ..... 8-84
- Sensor, status ..... 6.12.3.6 ..... 6-83
- Sentence(s) ..... 10.2.3 ..... 10-7
- active ..... 8.3.10.4.13 ..... 8-78
- affirmative ..... 8.3.10.4.13 ..... 8-78
- complex ..... 8.3.10.4.13 ..... 8-78
- 10.2.3.4 ..... 10-9
- complexity ..... 10.2.3.4 ..... 10-9
- compound ..... 8.3.10.4.13 ..... 8-78
- 10.2.3.4 ..... 10-9
- conditional ..... 10.2.3.4.3 ..... 10-9
- imperative ..... 10.2.3.7.1 ..... 10-10
- indicative ..... 10.2.3.7.2 ..... 10-10
- length ..... 10.2.3.3 ..... 10-8
- linking ..... 10.2.2.2 ..... 10-7
- mood ..... 10.2.3.7 ..... 10-10
- negative ..... 8.3.10.4.13 ..... 8-78
- 10.2.3.8 ..... 10-10
- passive ..... 8.3.10.4.13 ..... 8-78
- person ..... 10.2.3.7 ..... 10-10
- positive ..... 10.2.3.8 ..... 10-10
- punctuation ..... 10.2.3.10.3 ..... 10-11
- quotations, not for emphasis
- 10.3.3.7.7 ..... 10-30
- simple ..... 8.3.10.4.13 ..... 8-78
- 10.2.3.4 ..... 10-9
- structure ..... 8.3.10.4.13 ..... 8-78
- subordinate clauses ..... 10.2.3.4.2 ..... 10-9
- topic ..... 10.2.2.3 ..... 10-7
- voice ..... 10.2.3.6 ..... 10-10
- word order ..... 10.2.3.5 ..... 10-9
- wording ..... 10.2.3.1 ..... 10-8
- Sequence control (*see* Interaction, user-computer)
- Service point(s) (*see also* Test points)
- 6.14 ..... 6-89 - 6-93
- accessibility ..... 6.14.2.4 ..... 6-89
- 6.14.4 ..... 6-91
- accessible ..... 6.15.1.3.1 ..... 6-95
- clearances around ..... 6.14.4.1 ..... 6-91
- 6.14.5.2 ..... 6-92
- compatibility ..... 6.14.2.10 ..... 6-90
- distinctive connectors ..... 6.14.2.11 ..... 6-90
- distinctive fittings ..... 6.14.2.11 ..... 6-90
- isolated ..... 6.14.2.9 ..... 6-90
- label
- distinguishable ..... 6.14.6.2, 6.14.6.3 ..... 6-93
- identification ..... 6.14.6.5 ..... 6-93
- location ..... 6.14.6.1 ..... 6-93
- markings ..... 6.14.6.6 ..... 6-93
- tolerance limits ..... 6.14.6.7 ..... 6-93
- warning ..... 6.14.6.4 ..... 6-93
- location ..... 6.14.2.5 ..... 6-89
- 6.14.2.6 ..... 6-89
- 6.14.6.8 ..... 6-93
- minimizing ..... 6.14.2.8 ..... 6-90
- recessed ..... 6.14.5.4 ..... 6-92
- 6.14.2.7 ..... 6-90
- Servicing, minimizing ..... 6.14.2.7 ..... 6-90
- Shading
- and reproduction (of a document)
- 10.3.3.9.3 ..... 10-31
- as a typographic cue ..... 10.3.3.9 ..... 10-31
- in formatting tables ..... 10.4.5.4.5 ..... 10-39
- Shadows, eliminating ..... 13.4.1.3 ..... 13-8
- "Shall" (use of in this HFDG)
- 1.4.1.1 ..... 1-3
- "Shall" (use of in user documentation)
- 10.2.4.5.2 ..... 10-14
- Shape
- of access cover ..... 6.5.3 ..... 6-30
- of access opening ..... 6.4.4 ..... 6-26
- of equipment ..... 6.2.4.1, 6.2.4.2 ..... 6-8
- Shape coding ..... 8.5.4.9 ..... 8-75
- controls ..... 7.4.1.4.4 ..... 7-60
- controls for blind operation
- 7.4.1.5.3 ..... 7-62
- key-operated switches
- 7.4.4.2.2 ..... 7-67

- Shape coding (continued)
- knobs ..... 7.4.4.4.3 ..... 7-68
  - number of shapes ..... 8.5.4.9.1 ..... 8-75
  - rotary selector switches ..... 7.4.4.1.4 ..... 7-65
- Shield(s) ..... 6.5 ..... 6-28 - 6-34
- 12.5.2 ..... 12-15
  - around lubrication points ..... 6.14.5.6 ..... 6-92
  - different forms of ..... 6.5 ..... 6-28
  - for CRT displays ..... 7.2.4.3.2 ..... 7-24
  - ground connections to ..... 12.4.4.7 ..... 12-12
  - on drawers ..... 6.3.3.1.8 ..... 6-16
  - on equipment ..... 12.5.2.1 ..... 12-15
  - 12.5.2.4 ..... 12-16
  - on racks ..... 6.3.3.1.8 ..... 6-16
  - protecting conductors ..... 6.9.1.1.8 ..... 6-58
- Shielding
- cryogenic systems ..... 12.10.1 ..... 12-19
  - from hazards ..... 6.4.5.3 ..... 6-27
  - 6.15.1.2.1 ..... 6-94
  - 6.15.1.2.7 ..... 6-95
  - 12.8.4 ..... 12-18
- Shock, environmental ..... 4.3.2.b ..... 4-5
- Shock mounts ..... 6.10.4.7 ..... 6-77
- Shortcut features ..... 8.6.1.5.14 ..... 8-130
- Short-term memory
- in user-computer interaction ..... 8.1.1.1.2 ..... 8-2
  - in window design ..... 8.2.1.8.1 ..... 8-44
- "Should" (use of in this HFDG)
- 1.4.1.1 ..... 1-3
- "Should" (use of, in user documentation)
- 10.2.4.5.2 ..... 10-14
- "Show" (query language operation)
- 8.1.14.5.3.d ..... 8-34
- Shutoff devices, providing
- 12.6.3 ..... 12-16
- Side tone ..... 7.3.5.4.7 ..... 7-48
- Signs, maximum load ..... 9.3.3.5.1.a ..... 9-12
- Signal(s), visual devices .. 7.2.1.5 ..... 7-9
- Signal flow ..... 6.9.1.4.5 ..... 6-62
- checks ..... 6.9.1.7.4 ..... 6-64
  - indications ..... 6.10.2.2.2.c ..... 6-73
- Signature recognition, as identification and authentication ..... 11.3.3 ..... 11-8
- Simplicity in design ..... 4.1.1 ..... 4-1
- Human interfaces ..... 5.1.3 ..... 5-2
  - Maintenance automation ..... 5.1.3 ..... 5-2
- Simulations (*see* Models)
- Simultaneous access to control and display
- 7.1.2.12 ..... 7-3
- Simultaneous key combinations
- function key and other keys ..... 8.1.12.13, 8.1.12.14 ... 8-28
- Simultaneous use of controls and displays by multiple maintainers ..... 7.1.1.7 ..... 7-2
- Situation awareness
- bigger picture ..... 5.2.19 ..... 5-8
  - concept ..... 5.1.4 ..... 5-3
  - decision making ..... 5.1.4 ..... 5-3
  - display objective ..... 5.2.20 ..... 5-9
  - displays ..... 5.1.4 ..... 5-3
  - environmental status .. 5.1.4 ..... 5-2
  - information automation objective ..... 5.2.20 ..... 5-9
  - integrated displays ..... 5.2.19 ..... 5-8
  - perceptual and cognitive aspects ..... 5.1.4 ..... 5-3
  - projects systems outcomes ..... 5.1.4 ..... 5-2
  - status at a glance displays ..... 5.1.4 ..... 5-3
  - Situation displays (*see also* Map displays) as overlays ..... 8.5.8.1.5 ..... 8-118
- Size
- of access openings ..... 6.4.3 ..... 6-24
  - of cases ..... 6.6.2 ..... 6-35
  - of equipment ..... 6.2.3.1, 6.2.3.2 ..... 6-7
- Size coding ..... 8.5.4.10 ..... 8-107
- controls ..... 7.4.1.4.3 ..... 7-60
  - indicator lights ..... 7.2.2.3.3 ..... 7-17
  - key-operated switches ..... 7.4.4.2.2 ..... 7-67
  - number of sizes ..... 8.5.4.10.1 ..... 8-107
- Skill(s)
- minimizing ..... 6.1.1.1 ..... 6-2
  - 6.3.1 ..... 6-14
  - optimize ..... 6.1.4 ..... 6-5
- Skill level (of documentation users)
- 10.1.1.2 ..... 10-2
- Slide(s)
- ground connections to ..... 12.4.4.7 ..... 12-12
  - not as ground path ..... 12.4.4.8 ..... 12-12
- Slider(s) ..... 8.1.15.5 ..... 8-39
- components ..... 8.1.15.5.1 ..... 8-3
  - labeling ..... 8.1.15.5.4 ..... 8-40
  - numerical readout ..... 8.1.15.5.1 ..... 8-39
  - operation ..... 8.1.15.5.2 ..... 8-39
- Slide switches ..... 7.4.4.13 ..... 7-84
- accidental actuation prevention ..... 7.4.4.13.2 ..... 7-85
  - orientation ..... 7.4.4.13.3 ..... 7-85
  - positive feedback ..... 7.4.4.13.4 ..... 7-85
  - specifications ..... 7.4.4.13.1 ..... 7-82
- Sliding doors (*see* Doors)
- Smart cards, as identification and authentication ..... 11.3.3 ..... 11-8
- Snap-on collars ..... 6.7.3.7.6 ..... 6-46
- "Soft" function keys (*see* Function keys, "Soft")
- Software
- standardization ..... 4.1.3 ..... 4-1
- Soldered connections
- compatible (with requirements) ..... 6.8.5.2.8 ..... 6-53
  - damage by ..... 6.8.5.2.10 ..... 6-54
  - extra length ..... 6.8.5.2.11 ..... 6-54
  - spacing of ..... 6.8.5.2.9 ..... 6-53
  - 6.10.3.1.6 ..... 6-74
- Sound levels (*see* Noise, levels)
- Sound pressure levels, alerting signals
- 7.3.2.3.4 ..... 7-45
- Sources ..... 1.4.1.1 ..... Appendix B
- Space for work (*see* Work space)
- Spacing
- between characters ..... 8.2.3.3 ..... 8-48
  - between lines ..... 8.2.3.5 ..... 8-48
  - between paragraphs .. 8.2.3.6 ..... 8-49
  - between words ..... 8.2.3.4 ..... 8-48

- Special clothing, accommodating for  
6.5.1.5 ..... 6-29
- Spectral distribution of radiant energy  
12.14.3 ..... 12-24
- Specular reflectance, luminance of  
13.4.5.1 ..... 13-12
- Speech as auditory signals  
7.3.1.3 ..... 7-38
- Speech communication ... 12.12.4  
- 12.12.6 ..... 12-22  
13.5.2.6 ..... 13-16 - 13-17  
- 13.5.2.8 ..... 13-16 - 13-17
- Speech intelligibility ..... 7.3.5.6 ..... 7-52  
articulation index ..... 7.3.5.6.1.c ..... 7-53  
criteria ..... 7.3.5.6.2 ..... 7-53  
de-emphasis ..... 7.3.5.2.2 ..... 7-50  
evaluation method ..... 7.3.5.6.1 ..... 7-52  
modified rhyme test ... 7.3.5.6.1.b ..... 7-53  
phonetically balanced word intelligibility  
7.3.5.6.1.a ..... 7-52
- Speech interference ..... 12.12.2 ..... 12-21  
13.5.2.4 ..... 13-16
- Speech interference level, verbal warnings  
7.3.3.2 ..... 7-47
- Speech processing, verbal warning signals  
7.3.3.5 ..... 7-47
- Speech reception equipment (*see also* Headsets,  
Loudspeakers) ..... 7.3.5.2 ..... 7-49  
combined controls for power and volume  
7.3.5.4.3 ..... 7-51  
de-emphasis ..... 7.3.5.2.2 ..... 7-50  
duplicate emergency controls  
7.3.5.4.6 ..... 7-51  
foot-operated controls  
7.3.5.4.5, 7.3.5.4.6 ..... 7-51  
loudspeaker and headset in phase  
7.3.5.4.7 ..... 7-51  
separate controls for power and volume  
7.3.5.4.2 ..... 7-51  
speech intelligibility .. 7.3.5.2.2 ..... 7-50  
squelch control ..... 7.3.5.4.4 ..... 7-51
- Speech synthesizer(s) ..... 8.9.5.1 ..... 8-153  
8.9.8.1 ..... 8-156  
8.9.8.2 ..... 8-157  
10.6.1 ..... 10-66
- Speech transmission equipment  
7.3.5.1 ..... 7-47  
frequency range ..... 7.3.5.1.1 ..... 7-48  
microphones  
dynamic range ..... 7.3.5.1.2 ..... 7-49  
frequency range ... 7.3.5.1.1 ..... 7-48  
noise cancelling ... 7.3.5.1.3 ..... 7-49  
noise shields ..... 7.3.5.1.5 ..... 7-49  
pre-emphasis ..... 7.3.5.1.4 ..... 7-49
- Spell checker, on-line ..... 8.4.2.1.9 ..... 8-90
- Spelling  
in a user document ..... 10.2.4.9.1 ..... 10-16  
variations in a query language  
8.1.14.3.3 ..... 8-32
- Spring(s), releasing energy  
12.3.5 ..... 12-5
- Spring closure mechanism  
9.3.4.3.2 ..... 9-15
- Square, distinguishing mark for menu options  
8.3.7.3.5.e ..... 8-67
- Squelch control ..... 7.3.5.4.4 ..... 7-51
- Stacking  
commands (*see* Command stacking)  
menu selections (*see* Menu selection, stacking)
- Stair(s) ..... 9.3.5 ..... 9-19  
9.3.5.4 ..... 9-23  
12.2.2 ..... 12-3  
combined with ramp .. 9.3.5.3.3 ..... 9-22  
construction materials  
9.3.5.2.1 ..... 9-20  
de-icing ..... 9.3.5.2.1 ..... 9-20  
12.2.2.7 ..... 12-4  
design requirements ... 9.3.5.2 ..... 9-20  
dimensions for ..... 9.3.5.4.1 ..... 9-23  
emergency exit ..... 9.3.4.4.3 ..... 9-23  
entrance to catwalk ... 9.3.2.4 ..... 9-10  
handrails on ..... 9.3.5.2.5 ..... 9-21  
illumination for ..... 9.3.5.2.6 ..... 9-21  
landings between ..... 9.3.5.4.2 ..... 9-23  
nonskid materials on .. 9.3.5.2.3 ..... 9-21  
12.2.1.7 ..... 12-2  
risers ..... 9.3.5.4.2, 9.3.5.4.4 ..... 9-23  
selection of ..... 9.3.5.1.1 ..... 9-19  
strength of ..... 9.3.5.2.2 ..... 9-20  
treads ..... 9.3.5.4.3, 9.3.5.4.4 ..... 9-23  
warning labels on ..... 9.3.5.2.4 ..... 9-21  
when not to use ..... 9.3.5.1.3.b ..... 9-20  
when to use ..... 9.3.5.1.1 ..... 9-19
- Stair ladders ..... 9.3.5.5 ..... 9-25  
dimensions for ..... 9.3.5.5.1 ..... 9-25  
kickplates ..... 9.3.5.5.3 ..... 9-26  
location ..... 9.3.5.5.2 ..... 9-26  
screens ..... 9.3.5.5.3 ..... 9-26  
separation ..... 9.3.5.5.2 ..... 9-26  
treads ..... 9.3.5.5.3 ..... 9-26
- Stand(s) (*see also* Braces)  
6.2.7.1 - 6.2.7.3 ..... 6-12  
6.10.4.4 ..... 6-76
- Standard  
abbreviations ..... 10.2.4.8.5 ..... 10-16  
actions (for push buttons)  
8.1.15.2.5 ..... 8-38  
Appendix C  
message formats ..... 8.3.12.5.2 ..... 8-84  
phrases ..... 10.2.3.9 ..... 10-11  
verbs for maintenance instruction  
10.2.4.4.1 ..... 10-13  
Appendix D
- Standardization in design  
4.1.2 - 4.1.3 ..... 4-1  
4.1.4 ..... 4-2
- Static charge buildup in equipment  
12.4.1.4 ..... 12-7
- Status  
indicator, in system title bar  
8.3.9.2.2 ..... 8-70  
of equipment ..... 6.12.3.7 ..... 6-83  
of sensors ..... 6.12.3.6 ..... 6-83  
"Status" (query language control operation)  
8.1.14.5.2.d ..... 8-34
- Status displays  
acronyms ..... 5.7.9 ..... 5-21  
alert alarm, com ..... 5.4.5 ..... 5-15  
alphanumerics ..... 5.7.9 ..... 5-21  
automatic switching ... 5.4.5 ..... 5-15  
communications subsystem  
5.4.5 ..... 5-15  
constant access ..... 5.7.4 ..... 5-20



- Status displays (continued)
- continuous display ..... 5.4.5 ..... 5-15
    - 5.7.2 ..... 5-19
  - dedicated display ..... 5.7.4 ..... 5-19
  - diagnostics ..... 5.7.7 ..... 5-21
  - failure of transparent components
    - 5.4.5 ..... 5-15
  - graphical representation
    - 5.7.2 ..... 5-19
  - historical diagnostic data
    - 5.4.5 ..... 5-16
  - maintenance information system
    - 5.9.7 ..... 5-27
  - measurement unit ..... 5.7.9 ..... 5-21
  - text ..... 5.7.9 ..... 5-21
  - updating frequency ... 5.7.3 ..... 5-20
- Step(s)
- in proceduralized instructions
    - 10.5.1.1 ..... 10-49
    - 10.5.1.5 ..... 10-52
  - not in warnings, cautions, and notes
    - 10.4.8.6 ..... 10-43
  - task ..... 10.2.3.9.2 ..... 10-11
- Stools, uncushioned ..... 9.4.4.8 ..... 9-42
- "Stop"
- user interrupt ..... 8.1.4.1, 8.1.4.5 ..... 8-9
  - push button in "working" message window
    - 8.3.10.2.13 ..... 8-76
- Stop(s)
- for alignment ..... 6.2.8.1 ..... 6-12
  - for covers ..... 6.5.1.6 ..... 6-29
    - 6.5.5.2 ..... 6-30
  - for handles ..... 6.2.5.2.6 ..... 6-9
  - on equipment ..... 6.3.3.2.1 ..... 6-16
    - 9.3.3.5.2 ..... 9-12
  - to limit control range . 6.11.15 ..... 6-81
- Storage provisions, design compatibility
  - 4.3.1.d ..... 4-5
- Storage space ..... 6.15.7 ..... 6-100
- for cables ..... 6.9.1.1.13 ..... 6-58
    - 6.9.1.6.5 ..... 6-63
  - for removable items ... 6.15.7.1 ..... 6-100
  - labeling ..... 6.15.7.3 ..... 6-100
  - work and passage ..... 9.2.1.12 ..... 9-4
- "Store" graphic displays and elements
  - 8.5.8.4.6.d ..... 8-123
- Stored energy devices
- safety features ..... 12.3.6 ..... 12-5
  - warning placards ..... 12.3.6 ..... 12-5
- Storyboarding ..... 5.6.3 ..... 5-19
- Strainers, built-in ..... 6.14.2.12 ..... 6-90
- Straps ..... 6.10.4.5 ..... 6-76
- Strength
- categories of ..... 14.5.1 ..... 14-43
  - differences in handedness
    - 14.5.1 ..... 14-43
  - differences in sex ..... 14.5.1 ..... 14-43
    - 14.5.2.1 ..... 14-43
    - 14.5.2.4 ..... 14-46
  - factors ..... 14.5.1 ..... 14-43
  - female ..... 14.5.2.1 ..... 14-43
  - human ..... 14.5 ..... 14-42 - 14-52
  - values
    - decremented ..... 14.5.2.3 ..... 14-46
    - increasing ..... 14.5.2.2 ..... 14-45
- Stress
- physical ..... 4.2.1.b ..... 4-3
  - psychophysiological .. 4.2.1.b ..... 4-3
- Stroke width on labels ..... 6.3.5.3.2 - 6.3.5.3.6 ... 6-21
- Style of this HFDG ..... 1.4.2 ..... 1-4
- Stylus and grid ..... 8.8.3.5 ..... 8-143
- appropriate use ..... 8.8.3.5 ..... 8-143
  - grid orientation ..... 8.8.3.5.3 ..... 8-144
  - grid size ..... 8.8.3.5.2 ..... 8-144
  - refresh rate ..... 8.8.3.5.1 ..... 8-144
- Subcontractors ..... 1.3.1 ..... 1-2
- Supervisory control ..... 5.3 ..... 5-9
- automated subsystems
    - 5.3.1 ..... 5-10
    - definition ..... 5.3 ..... 5-10
    - procedures driven ..... 5.3.6 ..... 5-12
    - systems analysis ..... 5.3.3 ..... 5-10
    - user information ..... 5.3.2 ..... 5-10
- Supplemental information
  - 1.4.2.4 ..... 1-5
- Supports ..... 6.2.8.2 ..... 6-12
- 6.3.3.2.4 ..... 6-17
  - body ..... 14.6.3 ..... 14-53
    - to reduce tremors .. 14.5.2.5 ..... 14-46
  - for maximum force ... 14.5.3.1 ..... 14-47
  - line ..... 6.9.2.3 ..... 6-68
- Suppression of information
  - 8.5.6.5 ..... 8-116
  - indication of ..... 8.5.6.5.1 ..... 8-116
  - indication of changes in suppressed information
    - 8.5.6.5.2 ..... 8-117
  - restoration ..... 8.5.6.5.3 ..... 8-117
- Surface(s)
- burr free ..... 12.5.1.9 ..... 12-15
  - polished ..... 13.4.5.4 ..... 13-12
  - reflection ..... 13.4.5.2 ..... 13-12
  - temperature ..... 12.10.1 ..... 12-19
- Survival ..... 4.2.3.d ..... 4-4
- "Suspend"
- session without logging off
    - 8.3.9.4.3.b ..... 8-72
  - user interrupt ..... 8.1.4.1 ..... 8-9
    - 8.1.4.10 ..... 8-10
    - status indication ..... 8.1.4.11 ..... 8-11
- Sustained operations ..... 13.1.1 ..... 13-1
- Switch(es) (*see also* Key-operated switches, Legend switches, ON OFF switches, Printed circuit switches, Rocker switches, Rotary selector switches, Slide switches, Toggle switches)
- connection point ..... 8.9.8.4 ..... 8-157
  - eyeblink ..... 8.9.8.4 ..... 8-157
  - for hazardous operations
    - 12.3.1 ..... 12-4
  - main-power
    - "Hot" side protection
      - 12.4.2.3 ..... 12-9
      - labeling ..... 12.4.2.1 ..... 12-9
      - location ..... 12.4.2.2 ..... 12-9
      - safeguarding ..... 12.4.2.4 ..... 12-9
    - safety ..... 12.4.1 ..... 12-6
      - 12.4.2.5 ..... 12-9
    - "sip and puff" ..... 8.9.8.4 ..... 8-157
    - special ..... 8.9.8.4 ..... 8-157
  - Switch box ..... 12.4.2.6 ..... 12-9
- Symbol(s)
- association of map symbols with features
    - 8.5.8.2.5 ..... 8-119
  - coding ..... 8.5.4.8 ..... 8-107
  - color coded ..... 8.2.4.3 ..... 8-54

- Symbol(s) (continued)
- brightness ..... 8.2.4.3.3 ..... 8-54
  - refresh rate ..... 8.2.4.3.4 ..... 8-54
  - size ..... 8.2.4.3.2 ..... 8-54
  - color coding in map displays
    - 8.5.8.2.8 ..... 8-120
  - design ..... 8.5.4.8.1 ..... 8-107
  - flash coding ..... 8.5.4.6.4 ..... 8-107
  - for omitted entry in a required field
    - 8.4.3.8.4 ..... 8-97
  - identification key ..... 8.5.8.2.7 ..... 8-119
  - in control labels ..... 7.5.5.6 ..... 7-101
  - in graphic data display, consistent use
    - 8.5.5.4.2 ..... 8-110
  - in map windows ..... 8.3.12.4.6 ..... 8-83
  - in message windows .. 8.3.10.2.3 ..... 8-75
  - in scroll bars ..... 8.3.3.3.2 ..... 8-58
  - 8.3.3.3.3 ..... 8-58
  - in user documentation
    - 10.2.4 ..... 10-12 - 10-19
    - circuit elements .... 10.2.4.13.1 ..... 10-18
    - electrical elements
      - 10.2.4.13.1 ..... 10-18
    - electronic elements
      - 10.2.4.13.1 ..... 10-18
    - for semiconductor devices
      - 10.2.4.12.1 ..... 10-18
    - graphic symbols ... 10.2.4.13.2 ..... 10-18
    - in flow charts ..... 10.2.4.14.1 ..... 10-18
    - in logic diagrams .. 10.2.4.13.3 ..... 10-18
    - letter(s) ..... 10.2.4.12.1 ..... 10-18
    - mathematical signs
      - 10.2.4.12.1 ..... 10-18
    - mechanical diagram
      - 10.2.4.13.2 ..... 10-18
    - special ..... 10.2.4.14.2 ..... 10-18
  - ionizing radiation ..... 12.16.10 ..... 12-31
  - labeling in map displays
    - 8.5.8.2.10 ..... 8-120
    - 8.5.8.4.2 ..... 8-122
  - library of standard symbols for map displays
    - 8.5.8.4.1 ..... 8-122
  - nonoverlapping in map displays
    - 8.5.8.2.9 ..... 8-120
  - print preview of ..... 8.5.8.4.10 ..... 8-123
  - selection in map windows
    - 8.6.12.4.10 ..... 8-84
  - special symbols ..... 8.5.4.8.2 ..... 8-107
  - tools for construction . 8.5.8.4.3 ..... 8-122
- Synonyms, recognition of
- 8.6.1.2.13 ..... 8-128
- System(s)
- acquisition ..... 1.3.1 ..... 1-2
  - human responsibilities
    - 5 ..... 5-1
  - human roles ..... 5 ..... 5-1
- System administrator ..... 11.3.1.9 ..... 11-5
- as "super-user" ..... 11.4.1 ..... 11-9
  - provided data reduction tools
    - 11.4.2 ..... 11-9
  - specifying audits ..... 11.4.3, 11.4.4 ..... 11-9
  - tasks ..... 11.3.1.1 ..... 11-5
  - "unlocking" terminals
    - 11.3.1.7 ..... 11-5
- System analysis ..... 5.3.3 ..... 5-10
- cognitive aspects tasks
    - 5.3.3.e ..... 5-11
  - supervisory control .... 5.3.3 ..... 5-10
- System design features .... 4.2.1 ..... 4-3
- System effectiveness
- C<sup>2</sup> models ..... 5.4.2 ..... 5-14
  - design remote control 5.8.1 ..... 5-25
  - diagnostics ..... 5.7.7 ..... 5-21
  - human interactions .... 5 ..... 5-1
  - NAS goal ..... 5.1.1 ..... 5-2
  - systems engineering ... 5.5.6 ..... 5-18
- System engineering
- cognitive task elements
    - 5.5.5 ..... 5-17
  - configuration control . 5.5.4 ..... 5-17
  - explicit human contributions
    - 5.5.2 ..... 5-17
  - human factors ..... 5.5.1 ..... 5-17
  - human performance ... 5.5.1 ..... 5-17
  - human roles ..... 5.5.1 ..... 5-17
  - NAS maintenance automation
    - 5.5 ..... 5-17
  - new technology ..... 5.5.1 ..... 5-17
  - system effectiveness .. 5.5.6 ..... 5-18
- System integrity, protection
- 11.5.1.1 ..... 11-9
- System interactions ..... 4.3 ..... 4-4 - 4-5
- System interrupts ..... 8.1.3.3.1 ..... 8-7
- System-level windows (*see* Windows, system-level)
- System menu (*see* Menu, system)
- System messages
- applications running .. 8.3.9.1.5 ..... 8-70
  - automatic log off ..... 8.3.9.1.6 ..... 8-70
  - system startup ..... 8.3.9.1.4 ..... 8-70
  - unavailability for log on
    - 8.3.9.1.1 ..... 8-69
- "System" option in system menu bar
- 8.3.9.4.1 ..... 8-71
- System response
- appropriate response to all user entries
    - 8.1.5.1.2 ..... 8-10
- System response time (*see also* Display response time, Display rate) .... 8.1.2 ..... 8-4
- acknowledgement of delayed processing
    - 8.1.2.4 ..... 8-5
  - and menu length ..... 8.1.11.1.5 ..... 8-20
  - appropriate time ..... 8.1.2.1 ..... 8-4
  - keyboard lockout ..... 8.1.2.6 ..... 8-6
  - maximum response times
    - 8.1.2.2 ..... 8-4
  - notification of display completion
    - 8.1.2.5 ..... 8-6
  - variability of response times
    - 8.1.2.3 ..... 8-5
- System safety ..... 12.1.1 ..... 12-1
- System security ..... 11 ..... 11-1 - 11-12
- controls ..... 11.1.2 ..... 11-2
- System startup ..... 8.3.9.1.4 ..... 8-70
- appearance of system window
    - 8.3.9.2.1 ..... 8-70
- T**
- Tab(s) (in a user document)
- bleed through markings
    - 10.1.2.1 ..... 10-3
    - 10.4.13 ..... 10-45
  - number of ..... 10.4.13.1 ..... 10-45
  - when to use ..... 10.4.13.1 ..... 10-45

- Tab key
- assigning input focus . 8.3.4.3.4 ..... 8-60
  - moving cursor to "next" and "previous" fields ..... 8-95
    - 8.4.3.5.6 ..... 8-95
  - navigation in tables .... 8.4.5.5 ..... 8-98
- Tables in displays ..... 8.4.5 ..... 8-98
- column labels ..... 8.4.5.2 ..... 8-98
  - justification ..... 8.4.5.4 ..... 8-98
  - large tables ..... 8.4.5.7 ..... 8-98
  - leading and trailing zeros ..... 8.4.5.3 ..... 8-98
  - navigation ..... 8.4.5.5, 8.4.5.6 ..... 8-98
  - row labels ..... 8.4.5.2 ..... 8-98
  - scrolling ..... 8.4.5.8 ..... 8-99
  - when to use ..... 8.4.5.1 ..... 8-98
- Tables in this HFDG ..... 1.4.2.4 ..... 1-4
- Tables in user documentation ..... 10.4.5 ..... 10-31 - 10-34
- content ..... 10.4.5.5 ..... 10-33
    - nonredundant ..... 10.4.5.5.2 ..... 10-33
    - relevant ..... 10.4.5.5.1 ..... 10-33
    - useful ..... 10.4.5.5.1 ..... 10-33
  - footnotes ..... 10.4.14.2 ..... 10-48
    - identification ..... 10.4.14.2 ..... 10-48
    - location ..... 10.4.14.3 ..... 10-48
  - formatting ..... 10.4.5.4 ..... 10-39
    - ease of reading .... 10.4.5.4.5 ..... 10-39
    - organization ..... 10.4.5.4.1 ..... 10-39
    - row and column labels ..... 10.4.5.4.3 ..... 10-39
    - type size ..... 10.4.5.4.1 ..... 10-39
    - units of measurement ..... 10.4.5.4.4 ..... 10-39
  - identification ..... 10.4.5.2 ..... 10-31 - 10-39
    - caption ..... 10.4.5.2.2 ..... 10-39
    - number ..... 10.4.5.2.1 ..... 10-38
    - title ..... 10.4.5.2.1 ..... 10-38
  - location ..... 10.4.5.3 ..... 10-39
    - consistent location 10.4.5.3.3 ..... 10-39
      - following first reference ..... 10.4.5.3.1 ..... 10-39
      - preferred location . 10.4.5.3.2 ..... 10-39
    - orientation ..... 10.4.5.6 ..... 10-40
      - alternate ..... 10.4.5.6.2 ..... 10-40
      - preferred ..... 10.4.5.6.1 ..... 10-40
  - oversize ..... 10.4.5.7 ..... 10-40
    - captions for ..... 10.4.5.7.2 ..... 10-40
    - facing pages ..... 10.4.5.7.1 ..... 10-40
    - foldout pages ..... 10.4.5.7.3 ..... 10-40
    - when to use ..... 10.4.5.1.1 ..... 10-38
- Table of contents in user documentation ..... 10.1.2.3 ..... 10-3
- 10.4.2 ..... 10-34
  - label for ..... 10.4.2.2 ..... 10-34
  - right-hand page ..... 10.4.2.4 ..... 10-34
  - what to include ..... 10.4.2.3 ..... 10-34
  - when to include ..... 10.4.2.1 ..... 10-34
- Tactile devices ..... 12.2.1.3 ..... 12-1
- Tag(s)
- mounting ..... 7.5.1.15 ..... 7-98
- Tagout ..... 12.4.1 ..... 12-6
- simultaneous use of .... 6.5.9 ..... 6-33
    - 6.5.9.1 ..... 6-33
    - 6.5.9.2 ..... 6-33
    - 6.6.5 ..... 6-36
      - 6.6.5.1 ..... 6-37
      - 6.6.5.2 ..... 6-37
        - 12.4.1.11 ..... 12-8
- Tailoring (*see also* Customization by user) of this HFDG ..... 1.3.1 ..... 1-2
- Targets
- small ..... 8.9.2.5 ..... 8-152
- Task(s)
- activities ..... 14.1.2.1 ..... 14-3
  - checkout ..... 6.12.3.1 ..... 6-82
  - considerations ..... 14.4.1 ..... 14-36
  - effects of, ..... 9.1.1 ..... 9-1
  - human ..... 14.1.2.1 ..... 14-3
  - inspection ..... 6.12.3.1 ..... 6-82
  - manipulation ..... 14.4.4 ..... 14-38
  - repetitious ..... 14.4.5 ..... 14-42
    - requiring
      - fine manipulation .. 14.4.5 ..... 14-42
      - strength ..... 14.4.5 ..... 14-42
- Task analysis in user documentation ..... 10.2.1.5.1 ..... 10-6
- Task considerations ..... 14.3.1.2 ..... 14-16
- maintenance automation ..... 5.1.5 ..... 5-3
  - normal, backup, degraded modes ..... 5.1.5 ..... 5-3
- Task-oriented
- help ..... 8.6.1.3.1 ..... 8-128
  - in user documentation ..... 10.2.1.5.1 ..... 10-7
  - queries ..... 8.1.14.1.4 ..... 8-31
- Task performance
- expected ..... 14.1.2.1 ..... 14-3
  - in dark adaptation ..... 13.4.3.2 ..... 13-10
  - influenced by ..... 9.5.1 ..... 9-43
- Team consoles (*see* Consoles, multiperson)
- Team interaction
- communication links .. 5.6.1 ..... 5-18
  - control centers ..... 5.6.1 ..... 5-18
  - layout ..... 5.6.1 ..... 5-18
  - modes of operation ... 5.6.1 ..... 5-18
  - voice communications ..... 5.6.1 ..... 5-18
- Technical data, future program (*see also* Additional technical information) .... 5 ..... 5-1
- Technical terms in user documentation ..... 10.2.3.1.2 ..... 10-8
- Technology(ies) (*see* Tradeoffs)
- Telecommunication forms for Americans with disabilities ..... 7.6.4.1 ..... 7-115
- Telephone handsets (*see* Handsets, telephone)
- Telephone systems (*see also* Handsets, telephone)
- 7.3.5.5 ..... 7-52
    - cords ..... 7.3.5.5.2 ..... 7-52
    - frequency response ... 7.3.5.5.1 ..... 7-52
    - handset cradles ..... 7.3.5.5.3 ..... 7-52
    - multiple telephones, coding ..... 7.3.5.5.4 ..... 7-52
    - noisy environments ... 7.3.5.5.8 ..... 7-52
    - press-to-talk button ... 7.3.5.5.5 ..... 7-52
    - priority ..... 7.3.5.5.7 ..... 7-52
    - special environments . 7.3.5.5.1 ..... 7-52
    - switching ..... 7.3.5.5.6 ..... 7-52

- Temperature (*see also* Effective temperature)  
 and air quality ..... 9.3.2.6 ..... 9-10  
 design factors for ..... 13.1.a ..... 13-1  
 differentials ..... 13.2.1 ..... 13-2  
     13.3.9 ..... 13-7  
 dry bulb ..... 13.3.6 ..... 13-6  
 exposure to ..... 13.3.1 ..... 13-5  
 hazards ..... 12.10 ..... 12-19 - 12-20  
 in enclosed space ventilation  
     9.3.2.6 ..... 9-10  
 side wall ..... 13.3.9 ..... 13-7  
 surface ..... 12.10.1 ..... 12-19  
 uniform ..... 13.3.8 ..... 13-6  
 Tempest ..... 11 ..... 11-1  
 Terminal(s)  
 computer  
   locking out ..... 11.3.1.7 ..... 11-5  
   exposed ..... 12.4.1.12 ..... 12-8  
   identification of ..... 6.8.8.4 ..... 6-56  
     6.9.1.8.3 ..... 6-65  
     6.10.5.8 ..... 6-79  
   length of ..... 6.8.5.2.10 ..... 6-54  
   spacing of ..... 6.8.5.2.2 ..... 6-53  
     6.8.5.2.9 ..... 6-53  
     6.10.3.1.6 ..... 6-74  
   wire ..... 6.8.5.2.4 ..... 6-53  
 Terminating alarms ..... 8.1.3.5.2 ..... 8-8  
 Terminology in user documentation  
   10.2.4.1.1 ..... 10-12  
 lexicon, in design ..... 10.2.4.1.1 ..... 10-12  
 Term(s)  
 in data fields ..... 8.4.3.3.3 ..... 8-94  
 in user documentation  
   defined in glossary  
   10.4.10.1 ..... 10-44  
 Test and evaluation ..... 1.2.e ..... 1-1  
   4.3.3 ..... 4-5  
   11.1.5 ..... 11-2  
   human factors ..... 11.3.1.1 ..... 11-5  
   security ..... 11.1.5 ..... 11-2  
 Test cable(s) ..... 6.9.1.6 ..... 6-63  
 function ..... 6.9.1.6.2 ..... 6-63  
 noninterchangeable ..... 6.9.1.6.4 ..... 6-63  
 storage for ..... 6.9.1.6.5 ..... 6-63  
 use ..... 6.9.1.6.1, 6.9.1.6.3 ..... 6-63  
 Test equipment (*see also* Automatic Test equipment;  
 Built-in test equipment; Collating test equipment;  
 Go, no-go test equipment; Portable test  
 equipment)  
 accuracy of ..... 6.15.1.1.2 ..... 6-94  
 automatic shutoff ..... 6.15.1.4.3 ..... 6-96  
 calibration ..... 6.15.1.4.1 ..... 6-95  
 case for ..... 6.15.1.1.7 ..... 6-94  
 complexity of steps ..... 6.15.1.3.4 ..... 6-95  
 design ..... 6.15.1.1.1 ..... 6-94  
     6.15.1.2.4 ..... 6-95  
     6.15.1.3.5 ..... 6-95  
 exposed parts on ..... 6.15.1.2.3 ..... 6-95  
 fail-safe features ..... 6.15.1.2.5 ..... 6-95  
 instructions for ..... 6.15.1.1.6 ..... 6-94  
 minimizing ..... 6.1.1.1 ..... 6-2  
     6.15.1.3.2 ..... 6-95  
 number of steps ..... 6.15.1.3.4 ..... 6-95  
 operation ..... 6.15.1.3.3 ..... 6-95  
 selection ..... 6.15.1 ..... 6-94  
 standard, use of ..... 6.1.3.5 ..... 6-95  
 supports for ..... 6.15.6.2 ..... 6-92  
   warm-up indicator ..... 6.15.1.4.2 ..... 6-96  
     9.3.3.1.5 ..... 9-11  
   with plugs ..... 12.4.4.1.2 ..... 12-12  
 Testing  
 audio displays ..... 7.3.1.6 ..... 7-38  
 built-in ..... 6.1.1.1.d ..... 6-2  
 flag operation ..... 7.2.9.4.7 ..... 7-37  
 minimizing ..... 6.14.2.8 ..... 6-90  
 of human-machine interface design  
   4.3.3 ..... 4-5  
 separate ..... 6.3.1.4 ..... 6-14  
 Test leads  
 attaching to equipment  
   6.15.6.7 ..... 6-100  
 Test panel  
 arrangement of test points  
   6.15.2.4.3 ..... 6-98  
 coding test points on .. 6.15.2.4.5 ..... 6-98  
 providing, on test equipment  
   6.15.2.4.1 ..... 6-98  
   6.15.2.4.4 ..... 6-98  
 overlays ..... 6.15.2.4.4 ..... 6-98  
 Test point(s) (*see also* Service points)  
 6.14 ..... 6-89 - 6-93  
 accesses ..... 6.14.4.3 ..... 6-91  
 accessibility ..... 6.14.2.4 ..... 6-89  
   6.14.4 ..... 6-91  
 accessible ..... 6.15.1.3.1 ..... 6-95  
 arrangement ..... 6.14.2 ..... 6-89  
 clearance around ..... 6.14.5.2 ..... 6-92  
 coding ..... 6.15.2.4.5 ..... 6-98  
 compatibility ..... 6.14.2.10 ..... 6-90  
 connections ..... 6.15.2.4.2 ..... 6-98  
 cover ..... 6.14.4.4 ..... 6-92  
 distinctive connectors ..... 6.14.2.11 ..... 6-90  
 distinctive fittings ..... 6.14.2.11 ..... 6-90  
 for tracing signals ..... 6.14.2.3 ..... 6-89  
 for tracing voltage ..... 6.14.2.3 ..... 6-89  
 in built-in test equipment  
   6.15.2.2.1 ..... 6-97  
 indicator ..... 6.14.5.4 ..... 6-92  
 in plugs ..... 6.14.4.4 ..... 6-92  
 inputs ..... 6.8.5.1.13 ..... 6-52  
   6.14.2.1 ..... 6-89  
 isolated ..... 6.14.2.9 ..... 6-90  
 label  
   distinguishable ..... 6.14.6.2, 6.14.6.3 ..... 6-93  
   identification ..... 6.14.6.5 ..... 6-93  
   location ..... 6.14.6.1 ..... 6-93  
   markings ..... 6.14.6.6 ..... 6-93  
   tolerance limits ..... 6.14.6.7 ..... 6-93  
   warning ..... 6.14.6.4 ..... 6-93  
 location ..... 6.10.3.1.11 ..... 6-75  
   6.14.2 ..... 6-89  
   6.14.2.4 ..... 6-89  
   6.14.2.6 ..... 6-89  
   6.14.2.8 ..... 6-90  
 minimizing ..... 6.14.2.8 ..... 6-90  
 on cables ..... 6.9.1.7.4 ..... 6-64  
   6.15.6.6 ..... 6-99  
 outputs ..... 6.8.5.1.13 ..... 6-52  
   6.14.2.1 ..... 6-89  
 recessed ..... 6.14.5.3 ..... 6-92  
 shielding ..... 6.14.5.1 ..... 6-92  
 special ..... 6.14.2.13 ..... 6-90  
 with adjustment control  
   6.1.4.1.1, 6.1.4.1.2 ..... 6-89  
 Test probe(s), guides for ..... 6.14.4.2 ..... 6-91

Text

- cursor (*see* Cursor, text)
- in displays ..... 8.2.1.5 ..... 8-43
  - alternation between input devices ..... 8.4.2.1.4 ..... 8-89
  - blocks ..... 8.4.2.1.8 ..... 8-90
  - breaking up large portions ..... 8.2.1.5.1 ..... 8-43
  - consistent wording and structure ..... 8.5.2.1.1 ..... 8-103
  - distinguishable from control entries ..... 8.4.2.4.4 ..... 8-92
  - formatting ..... 8.4.2.3 ..... 8-90
  - input area ..... 8.4.2.1.1 ..... 8-89
  - in viewing area ..... 8.2.1.5.4 ..... 8-44
  - justification ..... 8.4.2.3.4 ..... 8-91
  - labeling ..... 8.5.2.2 ..... 8-103
  - lists ..... 8.2.1.5.2 ..... 8-43
  - moving through ..... 8.5.6.3.2 ..... 8-116
  - multiple cursors ..... 8.4.2.1.5 ..... 8-89
  - ordering information ..... 8.2.1.5.3 ..... 8-43
  - supplementary ..... 8.5.5.2.4 ..... 8-108
  - user-entered text distinguishable from system-  
.... supplied ..... 8.4.2.1.2 ..... 8-89
- in map displays ..... 8.5.8.5.4 ..... 8-123
- in windows ..... 8.3.10.4 ..... 8-77
  - abbreviations ..... 8.3.10.4.8 ..... 8-78
  - acronyms ..... 8.3.10.4.7 ..... 8-78
  - Arabic, not roman, numerals ..... 8.3.10.4.5 ..... 8-77
  - black characters, white background ..... 8.3.10.4.1 ..... 8-77
  - capitalization ..... 8.3.10.4.6 ..... 8-78
  - case conversion ..... 8.3.10.4.17 ..... 8-78
  - character size ..... 8.3.10.4.3 ..... 8-77
  - consistent structure for noneditable text ..... 8.3.10.4.11 ..... 8-78
  - dot matrixes ..... 8.3.10.4.2 ..... 8-77
  - punctuation ..... 8.3.10.4.14 ..... 8-78
  - referents ..... 8.3.10.4.16 ..... 8-78
  - sentence structure ..... 8.3.10.2.13 ..... 8-78
  - sequences ..... 8.3.10.4.15 ..... 8-78
  - user selectable character size ..... 8.3.10.4.4 ..... 8-77
  - vocabulary ..... 8.3.10.4.12 ..... 8-78
- wild card search characters ..... 8.3.10.4.18 ..... 8-79
- windows (*see* Windows, text)
- Third person sentences ..... 10.2.3.7.2 ..... 10-10
- Thread(s)
  - exposed ..... 12.5.1.10 ..... 12-15
  - fine ..... 6.7.3.2.5 ..... 6-42
  - left-hand ..... 6.7.3.1.6 ..... 6-41
- Threaded connectors, selection ..... 6.8.2.3.1 ..... 6-48
- Threat(s)
  - to data security ..... 11.5.1.3 ..... 11-9
  - to protected areas ..... 11.2 ..... 11-3
- Thumbwheels
  - continuous adjustment ..... 7.4.4.6 ..... 7-74
  - direction of movement ..... 7.4.4.6.3 ..... 7-75
  - OFF position ..... 7.4.4.6.5 ..... 7-75
  - orientation ..... 7.4.4.6.3 ..... 7-75
  - specifications ..... 7.4.4.6.1 ..... 7-74
  - surface friction ..... 7.4.4.6.4 ..... 7-75
  - when to use ..... 7.4.4.6.2 ..... 7-75
- discrete adjustment ..... 7.4.4.3 ..... 7-68
- ambient illumination ..... 7.4.4.3.5 ..... 7-69
- ..... 7.4.4.3.6 ..... 7-69
- character appearance ..... 7.4.4.3.5 ..... 7-69
- ..... 7.4.4.3.6 ..... 7-69
- coding ..... 7.4.4.3.3 ..... 7-68
- color coding ..... 7.4.4.3.3 ..... 7-68
- dimensions ..... 7.4.4.3.8 ..... 7-69
- direction of movement ..... 7.4.4.3.4 ..... 7-69
- internal illuminance ..... 7.4.4.3.5 ..... 7-69
- ..... 7.4.4.3.3 ..... 7-68
- OFF position ..... 7.4.4.3.3 ..... 7-68
- resistance ..... 7.4.4.3.9 ..... 7-70
- separation ..... 7.4.4.3.10 ..... 7-70
- shape ..... 7.4.4.3.2 ..... 7-68
- visibility ..... 7.4.4.3.7 ..... 7-69
- when to use ..... 7.4.4.3.1 ..... 7-68
- Tick marks on axes in graphic data displays ..... 8.5.5.4.10 ..... 8-111
- Time in job (of document users) ..... 10.1.1.1 ..... 10-2
- Time of day
  - in data displays ..... 8.5.1.9 ..... 8-102
  - in system title bar ..... 8.3.9.2.2 ..... 8-70
- Time weighted average (TWA) ..... 13.5.1.3 ..... 13-14
- ..... 13.5.1.4 ..... 13-15
- Title(s) ..... 10.2.1.1 ..... 10-4
- appendixes ..... 10.4.9.6 ..... 10-44
- application-level windows ..... 8.3.10.1.2 ..... 8-73
- data entry windows ..... 8.3.12.2.1 ..... 8-81
- display ..... 8.2.1.4.1 ..... 8-42
- figure captions ..... 10.4.4.2.2 ..... 10-36
- figures ..... 10.4.4.2.1 ..... 10-35
- figures, divided ..... 10.4.4.7.2 ..... 10-38
- forms ..... 8.4.3.1.1 ..... 8-92
- groups of menu options ..... 8.1.11.8.3, 8.1.11.8.4 ..... 8-26
- help displays ..... 8.6.1.5.5 ..... 8-129
- help windows ..... 8.3.12.1.2 ..... 8-80
- map windows ..... 8.3.12.4.1 ..... 8-93
- menus ..... 8.1.11.1.1 ..... 8-20
- message windows ..... 8.3.10.2.3 ..... 8-75
- of user documentation ..... 10.2.1 ..... 10-3
- paragraph ..... 10.2.1.1.2 ..... 10-4
- pull-down menus ..... 8.3.7.3.1 ..... 8-66
- same as menu option ..... 8.3.10.1.2 ..... 8-73
- system windows ..... 8.3.9.2.2 ..... 8-70
- table captions ..... 10.4.5.2.2 ..... 10-39
- tables ..... 10.4.5.2.1 ..... 10-38
- typographic cues ..... 10.2.1.1.3 ..... 10-4
- uniqueness of ..... 10.2.1.1.4 ..... 10-5
- Title bar (*see* Windows, title bar; Windows, system title bar; Windows, application title bar) ..... 8.3.11.2 ..... 8-79
- Toe board
  - height ..... 9.3.3.4.3 ..... 9-12
  - use ..... 12.2.2.4 ..... 12-4
- Toggle keys
  - nonvisual indication ..... 8.9.5.3 ..... 8-154

- Toggle switches ..... 7.4.4.10 ..... 7-79  
 accidental actuation prevention  
   7.4.4.10.5 ..... 7-79  
 orientation ..... 7.4.4.10.6 ..... 7-79  
 positive feedback ..... 7.4.4.10.5 ..... 7-79  
 specifications ..... 7.4.4.10.1 ..... 7-79  
 three-position toggle switches  
   7.4.4.10.3 ..... 7-79  
 when to use ..... 7.4.4.10.2 ..... 7-79  
 Tonal coding ..... 8.2.4.3 ..... 8-54  
 ordering to use ..... 8.2.4.2.1 ..... 8-53  
 when to use ..... 8.2.4.2.1 ..... 8-53  
 Tone(s)  
 as auditory signals ..... 7.3.1.3 ..... 7-42  
 Tongue-in-slot design ..... 6.7.2.4 ..... 6-40  
 Tool(s) ..... 6.1.6 ..... 6-101 - 6-102  
 automated, for map analysis  
   8.5.8.1.10 ..... 8-119  
 carried  
 effects on measurements  
   14.1.4.8 ..... 14-12  
   14.3.1.2 ..... 14-16  
 common ..... 4.1.6 ..... 4-2  
   6.1.3.1 - 6.1.3.6 ..... 6-4  
   6.2.4.2 ..... 6-8  
   6.16.1.2 ..... 6-101  
 hand tools ..... 6.16.2 ..... 6-101  
 design compatibility .. 4.3.1.e ..... 4-5  
 electric hand-held  
   cords for ..... 12.4.5.2 ..... 12-13  
   surfaces of ..... 12.4.5.3 ..... 12-13  
 for constructing symbols and overlays  
   8.5.8.4.3 ..... 8-122  
 minimizing ..... 6.1.1.1.i ..... 6-2  
   6.1.3.4 ..... 6-4  
   6.3.f ..... 6-13  
 special ..... 4.2.7 ..... 4-4  
   6.1.3.6 ..... 6-4  
   6.16.1.4 ..... 6-101  
   6.16.3 ..... 6-101  
 attach to equipment  
   6.16.3.4 ..... 6-101  
 availability ..... 6.16.3.3 ..... 6-101  
 checking existing tools  
   6.16.3.2 ..... 6-101  
 insulated handles .. 6.16.3.5 ..... 6-101  
 spark resistant ..... 6.16.3.6 ..... 6-102  
 requirements for ... 6.16.3.1 ..... 6-101  
 thongs for ..... 6.16.2.2 ..... 6-101  
 Topic completeness ..... 1.4.1.3 ..... 1-4  
 Topic sentences ..... 10.2.2.3 ..... 10-7  
 Torque  
 high  
   connectors ..... 6.8.3.7 ..... 6-50  
   fasteners ..... 6.7.3.3.6 ..... 6-43  
   on nuts ..... 6.7.3.1.4 ..... 6-41  
 Torsion bars, releasing energy  
   12.3.5 ..... 12-5  
 labels ..... 6.7.4.2 ..... 6-47  
 low  
   fasteners ..... 6.7.3.3.7 ..... 6-43  
   on nuts ..... 6.7.3.1.5 ..... 6-41  
 Touch controls ..... 14.4.4 ..... 14-38  
 Touch panel ..... 8.8.4.2 ..... 8-147  
 appropriate use ..... 8.8.4.1.2.a ..... 8-147  
 dimensions ..... 8.8.4.2.5 ..... 8-147  
 display feedback ..... 8.8.4.2.7 ..... 8-148  
 luminance transmission  
   8.8.4.2.3 ..... 8-147  
 positive indication .... 8.8.4.2.4 ..... 8-147  
 resistance ..... 8.8.4.2.6 ..... 8-147  
 separation ..... 8.8.4.2.5 ..... 8-147  
 use ..... 8.8.4.2.1 ..... 8-147  
 Toxic hazards ..... 12.7 ..... 12-16 - 12-18  
 control of ..... 13.2.8 ..... 13-3  
 Toxicity ..... 13.2.7 ..... 13-3  
 ventilation ..... 13.2.7 ..... 13-3  
 Tracks ..... 6.2.8.1 ..... 6-12  
 Trackball (*see* Ball controls)  
 Trademarks  
 in visual displays ..... 7.2.1.1.8 ..... 7-7  
 Tradeoffs ..... 1.2.c ..... 1-1  
 new technology ..... 5.5.1 ..... 5-17  
 Traffic areas ..... 9.3.1 ..... 9-8  
 design considerations . 9.3.1.4 ..... 9-9  
   9.3.2.1 ..... 9-10  
 Traffic flow  
 design considerations . 9.3.1.4 ..... 9-9  
 Trailing zeros (*see* Zeros)  
 Trained user (*see* Experienced user)  
 Training (*see also* Skills)  
 and automation ..... 5.10.2 ..... 5-28  
 automated decision aids  
   5.10.2 ..... 5-28  
   5.10.3 ..... 5-28  
 costs ..... 5.2.10 ..... 5-6  
 documentation no substitute  
   10.1 ..... 10-1  
 embedded ..... 5.10.1 ..... 5-28  
 initial security ..... 11.7.1 ..... 11-11  
 job-related (of document users)  
   10.1.1.1 ..... 10-2  
 level and data display format  
   8.5.5.1.3 ..... 8-108  
 minimizing ..... 6.1.1.1 ..... 6-2  
   6.1.4.1, 6.1.4.2 ..... 6-5  
   6.3.1 ..... 6-14  
   11.7.2 ..... 11-11  
 on computer ethics .... 11.7 ..... 11-11  
 on policies ..... 11.7 ..... 11-11  
 on procedures ..... 11.7 ..... 11-11  
 on responsibilities .... 11.7 ..... 11-11  
 power users ..... 5.10.1 ..... 5-28  
 procedural information  
   5.10.1 ..... 5-28  
 security ..... 11.7 ..... 11-11  
 security management . 11.7.3 ..... 11-11  
 specific security ..... 11.7.1 ..... 11-11  
 types of ..... 11.7.1 ..... 11-11  
 Transaction logs ..... 11.5.3 ..... 11-10  
 Transaction selection ..... 8.1.6 ..... 8-13  
 in user-computer interaction  
   8.1.6 ..... 8-13  
   command stacking 8.1.6.14 ..... 8-15  
   "Continue" operation  
     8.1.6.12 ..... 8-15  
   control options, list of  
     8.1.6.4, 8.1.6.5 ..... 8-14  
   cursor position for keying  
     8.1.6.11 ..... 8-14  
   cursor position for selection  
     8.1.6.10 ..... 8-14  
   defaults ..... 8.1.6.9 ..... 8-14  
   memory load ..... 8.1.6.2 ..... 8-14

Transaction selection (continued)

- option codes ..... 8.1.6.8 ..... 8-14
- options at completion
  - 8.1.6.13 ..... 8-15
- presentation of options
  - 8.1.6.7 ..... 8-14
- prompting ..... 8.1.6.3 ..... 8-14
- user-specification of timing
  - 8.1.6.1 ..... 8-13
- wording of options
  - 8.1.6.6 ..... 8-14

Transilluminated displays (*see also* Indicator lights, Legend lights, Panels, Transilluminated panels)

- 7.2.2 ..... 7-12
- general ..... 7.2.2.1 ..... 7-13
  - ambient illumination
    - 7.2.2.1.9, 7.2.2.1.10 ... 7-14
    - 7.2.2.1.13 ..... 7-14
  - color coding ..... 7.2.2.1.20 ..... 7-15
  - dimming control ... 7.2.2.1.10 ..... 7-14
  - false or obscured indication
    - 7.2.2.1.11 ..... 7-14
  - flashing lights ..... 7.2.2.1.21 ..... 7-15
  - grouping of indicator lights
    - 7.2.2.1.5 ..... 7-13
  - indicator circuit testing
    - 7.2.2.1.16 ..... 7-15
  - indicator covers ... 7.2.2.1.19 ..... 7-15
  - location of indicators
    - 7.2.2.1.6, 7.2.2.1.7 .... 7-13
  - luminance ..... 7.2.2.1.9, 7.2.2.1.10 ... 7-14
  - luminance contrast
    - 7.2.2.1.12, 7.2.2.1.13 . 7-14
  - meaning of illumination
    - 7.2.2.1.2 ..... 7-13
  - meaning of no illumination
    - 7.2.2.1.4 ..... 7-13
  - positive feedback .. 7.2.2.1.3 ..... 7-13
  - use of LEDs ..... 7.2.7.2 ..... 7-32
  - when to use ..... 7.2.2.1.1 ..... 7-13
- lamps
  - nonhazardous replacement
    - 7.2.2.1.18 ..... 7-15
  - redundancy ..... 7.2.2.1.14 ..... 7-14
  - removal and replacement
    - 7.2.2.1.17 ..... 7-15
    - 7.2.2.4.3 ..... 7-18
  - testing ..... 7.2.2.1.15 ..... 7-15

Transilluminated indicators (*see* Transilluminated displays)

Transmission

- delayed or unsuccessful
  - 8.3.12.5.6 ..... 8-84
- message ..... 8.3.12.5.5 ..... 8-84

"Transmit" push button for message transmission

- 8.3.12.5.5 ..... 8-84

Tremor, reducing ..... 14.5.2.5 ..... 14-46 - 14-47

Triangle, distinguishing mark for menu options

- 8.4.1.1.5 ..... 8-86
- 8.3.7.3.5.c ..... 8-67

Tunnels ..... 9.3.2 ..... 9-9

- approval for ..... 9.3.2.1 ..... 9-10

Tutorials to minimize memory load

- 8.1.1.12 ..... 8-2

Two-hand(ed) operation .. 14.4.4 ..... 14-40

Type size ..... 10.3.3.1 ..... 10-26 - 10-27

- 10.6.3.b ..... 10-66

- "basic" size ..... 10.3.3.1.1 ..... 10-26
- minimum size ..... 10.3.3.1.2 ..... 10-26
- number of different sizes
  - 10.3.3.1.4 ..... 10-27
- spacing of different sizes
  - 10.3.3.1.3 ..... 10-26

Type style ..... 10.3.3.5 ..... 10-28

- basic font ..... 10.3.3.5.1 ..... 10-28
- for control labels ..... 7.5.4.3 ..... 7-101
- Helvetica ..... 10.3.3.5 ..... 10-28
- in large-screen displays
  - 7.2.5.2.5 ..... 7-30
- legibility in CRT displays
  - 7.2.4.6.1 ..... 7-26
- minimize different fonts
  - 10.3.3.5.2 ..... 10-28
- sans serif fonts ..... 10.3.3.5 ..... 10-28
- serifs ..... 10.3.3.5.1 ..... 10-28
- Univers ..... 10.3.3.5 ..... 10-28

Typographic cues ..... 10.3.3 ..... 10-26 - 10-31

- color ..... 10.3.3 ..... 10-26
- 10.3.3.9 ..... 10-31
- intensity (boldness) ... 10.3.3 ..... 10-26
- in user documentation
  - 10.1.2.2, 10.1.2.3 ..... 10-3
- position ..... 10.3.3 ..... 10-26
- shading ..... 10.3.3.9 ..... 10-31
- titles and headings .... 10.2.1.1.3 ..... 10-4
- type size ..... 10.3.3 ..... 10-26
- upper case letters ..... 10.3.3 ..... 10-26
- white space ..... 10.3.2.3 ..... 10-22

Typographic emphasis .... 10.3.3.7 ..... 10-29 - 10-30

- boldface type ..... 10.3.3.7.2 ..... 10-29
- capitalization ..... 10.2.3.10.2 ..... 10-11
- informing the user .... 10.3.3.7.1 ..... 10-29
- italic type ..... 10.3.3.7.5 ..... 10-30
- sparing use of ..... 10.3.3.7.3 ..... 10-29
- underlining ..... 10.3.3.7.4 ..... 10-29
- upper case letters ..... 10.3.3.7.6 ..... 10-30

**U**

Unattended terminals ..... 11.3.1.9 ..... 11-5

Underscores as field designator

- 8.4.3.2.6 ..... 8-93

Understanding control operation

- 7.6.3.12 ..... 7-113
- build on user expense 7.6.3.12 ..... 7-113
- label ..... 7.6.3.12 ..... 7-113
- reduce number of control
  - 7.6.3.12 ..... 7-113
- sequences avoid or cue
  - 7.6.3.12 ..... 7-113
- simplify ..... 7.6.3.12 ..... 7-113

"Undo"

- an action ..... 8.1.1.17 ..... 8-3
- editing operation ..... 8.4.2.2.3 ..... 8-90
- error correction ..... 8.1.5.1.12 ..... 8-11
- user interrupt ..... 8.1.4.4 ..... 8-9

"Uninflammable," (use of in user documentation)

- 10.2.4.3.4 ..... 10-13

Unitization of equipment

- 6.3.1 ..... 6-14

Units of measurement (*see* Measurement, units of)

Univers font ..... 10.3.3.5 ..... 10-28

Update rate

- alphanumeric data ..... 8.5.7.1.3 ..... 8-117

- Update rate (continued)
  - for changing data ..... 8.5.7.1.1 ..... 8-117
  - real time data ..... 8.5.7.1.2 ..... 8-117
  - user control ..... 8.5.7.2 ..... 8-117
    - automatic updating ..... 8.5.7.2.2 ..... 8-118
    - display regeneration ..... 8.5.7.2.1 ..... 8-117
    - in map windows ... 8.3.12.4.11 ..... 8-84
    - update rate ..... 8.5.7.2.2 ..... 8-118
- Updating
  - a document ..... 10.3.1.2.3 ..... 10-20
  - a map display ..... 8.5.8.3.12 ..... 8-121
    - 8.5.8.3.15 ..... 8-121
  - CRT displays ..... 7.2.4.7.4 ..... 7-28
- Upper case (*see* Case (of letters))
- Usability of a query language
  - 8.1.14.4 ..... 8-33
- User(s) (*see also* Maintainer(s))
  - contractors ..... 1.3.1 ..... 1-2
  - expert (documentation for)
    - 10.1.1.2 ..... 10-2
  - FAA personnel ..... 1.3.1 ..... 1-2
  - novice (documentation for)
    - 10.1.1.2 ..... 10-2
  - of this HFDG ..... 1 ..... 1-1
    - human factors professionals
      - 1.3.1 ..... 1-2
    - power users ..... 10.1.1.2 ..... 10-2
    - skills ..... 10.1.1.2 ..... 10-2
- User acceptability ..... 5.2.12 ..... 5-7
  - acceptability testing ... 5.5.3 ..... 5-17
  - and performance ..... 5.2.12 ..... 5-7
  - artificial intelligence .. 5.6.3 ..... 5-19
  - in advance of commitments
    - 5.2.12 ..... 5-7
  - prototyping ..... 5.6.3 ..... 5-19
    - 5.2.12 ..... 5-7
  - roles, responsibilities . 5.2.12 ..... 5-7
  - storyboarding ..... 5.6.3 ..... 5-19
  - user involvement ..... 5.6.2 ..... 5-18
  - user perspectives language
    - 5.6.2 ..... 5-18
- User aids
  - graphic data entry and display
    - emergence of drawn objects
      - 8.4.6.3.4 ..... 8-101
    - plotting entered data
      - 8.4.6.3.1 ..... 8-101
    - plotting stored data
      - 8.4.6.3.2 ..... 8-101
    - scaling ..... 8.4.6.3.3 ..... 8-101
  - language
    - 8.1.14.1.5 ..... 8-31
    - 8.1.14.3.8 ..... 8-33
- User-centered on-line help
  - 8.6.1.1.4 ..... 8-126
- User-computer interaction
  - 8.1 ..... 8-1 - 8-40
    - abbreviations ..... 8.1.7 ..... 8-15
    - canceling actions ..... 8.1.1.17 ..... 8-3
    - closure ..... 8.1.1.19 ..... 8-3
    - consistency ..... 8.1.1.1 ..... 8-1
    - context ..... 8.2.1.3 ..... 8-41
    - customization ..... 8.1.1.13 ..... 8-2
    - equivalence of upper and lower case
      - 8.1.1.16 ..... 8-3
    - feedback ..... 8.1.3.2 ..... 8-7
    - interaction method .... 8.1.8 ..... 8-16
    - interrupts ..... 8.1.3.3 ..... 8-7
      - matched to user abilities
        - 8.1.1.2 ..... 8-1
    - memory load ..... 8.1.1.12 ..... 8-2
    - minimum number of actions
      - 8.1.1.7 ..... 8-2
    - multiple users ..... 8.1.1.14 ..... 8-3
    - names of control functions
      - 8.1.1.18 ..... 8-3
    - no repetitive entries ... 8.1.1.8 ..... 8-2
    - pace ..... 8.1.1.4 ..... 8-2
    - paging ..... 8.1.1.15 ..... 8-3
    - prompting ..... 8.1.3.1 ..... 8-6
    - scrolling ..... 8.1.1.15 ..... 8-3
    - transaction selection .. 8.1.6 ..... 8-13
    - transaction wording ... 8.1.1.10 ..... 8-2
    - simplicity ..... 8.1.1.6 ..... 8-2
    - undoing actions ..... 8.1.1.17 ..... 8-3
    - user control ..... 8.1.1.3 ..... 8-1
    - user expectations ..... 8.1.1.11 ..... 8-2
    - user perspective ..... 8.1.1.9 ..... 8-2
- User control
  - data transmission ..... 8.7.1.5 ..... 8-130
  - explicit actions (*see also* "Enter")
    - 8.1.1.5 ..... 8-3
    - 8.7.1.4 ..... 8-130
  - in map windows ..... 8.3.12.4.5 ..... 8-83
    - 8.3.12.4.7 ..... 8-83
  - in user-computer interaction
    - 8.1.1.3 ..... 8-1
  - in window design ..... 8.2.1.12.1 ..... 8-117
  - interruption of message preparation, review, and disposition ..... 8.7.1.6 ..... 8-124
  - level and type of system messages received
    - 8.1.3.6.2 ..... 8-130
  - message
    - addressing ..... 8.7.3.1 ..... 8-131
    - cancellation ..... 8.7.4.2.6, 8.7.5.2.2 ... 8-133
    - delivery ..... 8.7.4.2.4 ..... 8-133
    - preparation ..... 8.7.2.2 ..... 8-131
    - reception ..... 8.7.6.2, 8.7.6.3 ..... 8-134
      - 8.7.6.2.1 ..... 8-131
    - transmission ..... 8.7.4.2 ..... 8-133
      - 8.7.5.2 ..... 8-133
  - of auditory signals .... 8.5.4.3.2 ..... 8-105
  - of data displayed ..... 8.5.1.7 ..... 8-102
  - of display ..... 8.5.6 ..... 8-115
    - control information
      - 8.5.6.2.3 ..... 8-115
    - control locations ... 8.5.6.2.1 ..... 8-115
    - control options ..... 8.5.6.2.1 ..... 8-115
    - default values ..... 8.5.6.2.2 ..... 8-115
    - freezing display ... 8.5.7.3.1 ..... 8-118
      - 8.2.1.12.1, 8.2.1.12.2 ..... 8-46
    - return to normal display
      - 8.5.6.1.2 ..... 8-115
    - tailoring ..... 8.5.6.1.1 ..... 8-115
    - update rate ..... 8.5.7.2.2 ..... 8-118
      - 8.2.1.12.1, ..... 8-46
      - 8.2.1.12.2 ..... 8-46
  - of interaction in windows
    - 8.1.1.21 ..... 8-3



- User control (continued)
- of pace in user-computer interaction
    - 8.1.1.4 ..... 8-2
  - of sequencing in map displays
    - 8.5.8.3.16
    - 8.5.8.3.18 ... 8-121 - 8-122
  - of transaction timing .. 8.1.6.1 ..... 8-13
  - of updating in map windows
    - 8.3.12.4.11 ..... 8-84
  - procedures
    - consistency ..... 8.7.1.2 ..... 8-130
    - memory load ..... 8.7.1.3 ..... 8-130
- User document (*see* Document, user)
- User documentation terms consistent with control labels ..... 7.5.5.3 ..... 7-101
- User expectations
  - color meanings ..... 8.2.4.1.1.c ..... 8-50
  - data display ..... 8.5.1.2 ..... 8-102
  - map displays ..... 8.5.8.1.1 ..... 8-118
- User feedback forms in HFDG
  - foreword ..... ii
  - ..... after index
- User feedback forms in user documentation
  - 10.4.12 ..... 10-44
  - 10.4.12.3 ..... 10-45
  - location ..... 10.4.12.2 ..... 10-45
  - number of copies ..... 10.4.12.4 ..... 10-45
  - when to use ..... 10.4.12.1 ..... 10-44
- User guidance (*see also* User aids)
  - 8.6 ..... 8-125 - 8-130
  - error messages (*see also* Messages, error)
    - 8.1.5.2 ..... 8-11
  - on-line help (*see also* On-line help)
    - 8.6.1 ..... 8-125
  - routine messages (*see also* Messages, routine)
    - 8.1.3.6 ..... 8-9
  - status information ..... 8.1.3.4 ..... 8-8
    - alarm settings ..... 8.1.3.4.2 ..... 8-8
    - availability ..... 8.1.3.4.1 ..... 8-8
    - other systems or users
      - 8.1.3.4.3 ..... 8-8
  - system-detected need for help
    - 8.1.5.2.1 ..... 8-11
- User guides ..... 10 ..... 10-1
  - size ..... 10.3.1.1 ..... 10-19
- User-id
  - validity ..... 11.3.1.8 ..... 11-5
- User interface (*see* human interface)
- User manuals (*see also* User guides)
  - 10 ..... 10-1
- User population ..... 14.1.1 ..... 14-1 - 14-2
- User preferences (*see* Customization by user)
- User settings (*see* Customization by user)
- User tailoring (*see* Customization by user)
- Uses of this HFD Guide .. 1.1 ..... 1-1
  - 1.2 ..... 1-1
  - government HF professionals
    - 1.3.1 ..... 1-2
  - contractor ..... 1.3.1 ..... 1-2
  - systems and equipment
    - 4.1.1 ..... 4-1
- Using this HFD Guide ..... 1.4 ..... 1-3 - 1-5
- "Utilities" option in system menu bar
  - 8.3.9.4.2 ..... 8-72
- Utilities menu (*see* Menu(s), utilities)
- V**
- Validation
  - format and content ..... 8.4.7.1 ..... 8-101
  - graphic data ..... 8.5.5.3.1 ..... 8-109
    - on input ..... 8.4.6.1.4 ..... 8-99
  - invalid data ..... 8.4.7.3 ..... 8-101
  - message addresses ..... 8.7.3.4.1 ..... 8-132
  - probable error ..... 8.4.7.4 ..... 8-101
  - valid data ..... 8.4.7.2 ..... 8-101
- Valve(s)
  - controls ..... 7.4.1.2.2, 7.4.1.2.3 ..... 7-55
  - cutoff ..... 6.9.2.1.10 ..... 6-67
  - drain cock
    - labeling ..... 6.14.3.5 ..... 6-91
  - drain plug
    - motion ..... 6.14.3.5 ..... 6-91
    - requirements ..... 6.14.3.4 ..... 6-91
  - instructions ..... 6.14.3.7 ..... 6-91
  - labeling ..... 6.14.3.5 ..... 6-91
    - 7.4.1.2.3 ..... 7-55
  - use ..... 6.14.3.3 ..... 6-91
- Variability of system response times
  - 8.1.2.3 ..... 8-5
- VDT (*see* Visual Display Terminals)
- Ventilation ..... 13.2 ..... 13-2 - 13-3
  - design factors for ..... 13.1.a ..... 13-1
  - enclosure
    - large ..... 13.2.3 ..... 13-2
    - small ..... 13.2.2 ..... 13-2
  - for crawl spaces ..... 9.3.2.6 ..... 9-10
  - for enclosed catwalks ..... 9.3.2.6 ..... 9-10
  - for toxic substances .. 13.2.7 ..... 13-3
  - for tunnels ..... 9.3.2.6 ..... 9-10
  - holes
    - in covers ..... 6.5.1.7 ..... 6-29
      - 12.5.2.3 ..... 12-16
      - 12.10.2 ..... 12-20
    - in shields ..... 6.5.1.7 ..... 6-29
      - 12.5.2.3 ..... 12-16
      - 12.10.2 ..... 12-20
  - intakes ..... 13.2.6 ..... 13-3
  - of dust ..... 13.2.5 ..... 13-3
  - of fumes ..... 13.2.5 ..... 13-3
  - of gases ..... 13.2.5 ..... 13-3
  - of vapors ..... 13.2.5 ..... 13-3
  - providing ..... 12.7.3, 12.7.4 ..... 12-17
    - 12.9.5 ..... 12-19
  - systems ..... 13.2.1 ..... 13-2
    - 13.2.4 ..... 13-3
- Verbal warnings (*see* Warning signals, verbal)
- Vertical spacing in user documentation
  - 10.3.2.3.1 ..... 10-22
- Vibration
  - design factors for ..... 13.1.b ..... 13-1
  - environmental ..... 4.3.2.b ..... 4-5
  - visual displays ..... 7.2.1.6.5 ..... 7-10
- Viewing angle
  - counters in visual displays
    - 7.2.9.1.2 ..... 7-39
  - CRT displays ..... 7.2.4.5.3 ..... 7-26
  - dot matrixes ..... 7.3.6.4 ..... 7-32
  - large-screen displays .. 7.2.5.1.2 ..... 7-28
    - 7.2.5.2.3 ..... 7-30

- Viewing distance  
 character height ..... 8.2.3.7 ..... 8-49  
     8.3.10.4.3 ..... 8-77  
 character height in CRT displays  
     7.2.4.6.2 ..... 7-26  
 control labels ..... 7.5.3.1 ..... 7-99  
 CRTs ..... 7.2.1.6.14 ..... 7-12  
     7.2.4.5.1, 7.2.4.5.2 ..... 7-25  
 large-screen displays . 7.2.5.1.2, 7.2.5.1.3 ..... 7-28  
     7.2.5.2.2 ..... 7-30  
 targets on CRT displays  
     7.2.4.7.2 ..... 7-27  
 visual displays  
     maximum ..... 7.2.1.6.11 ..... 7-11  
     minimum ..... 7.2.1.6.12 ..... 7-11  
     preferred ..... 7.2.1.6.13 ..... 7-11
- Visual access (*see also* Access)  
 controls ..... 9.5.4.4 ..... 9-51  
 displays ..... 9.5.4.4 ..... 9-51
- Visual and auditory outputs for cognitively disabled  
 attention-getting ..... 7.6.2.7 ..... 7-108  
 highlighting ..... 7.6.2.7 ..... 7-108  
 icons ..... 7.6.2.7 ..... 7-108  
 important text first ..... 7.6.2.7 ..... 7-108  
 one thing at a time ..... 7.6.2.7 ..... 7-108  
 screens ..... 7.6.2.7 ..... 7-108  
 short audio ..... 7.6.2.7 ..... 7-108  
 short menus ..... 7.6.2.7 ..... 7-108  
 simple language ..... 7.6.2.7 ..... 7-108
- Visual angle  
 characters and symbols in electroluminescent  
 displays ..... 7.2.8.1 ..... 7-33  
 characters on CRT displays  
     7.2.4.6.2 ..... 7-26  
 characters on large-screen displays  
     7.2.5.2.6 ..... 7-31  
 color coded symbols 8.2.4.3.2 ..... 8-54  
 dot matrixes ..... 7.2.6.3 ..... 7-32  
 targets on CRT displays  
     7.2.4.7.2 ..... 7-27
- Visual coding (*see also* Flash coding)  
     7.2.1.3 ..... 7-8  
 accompanying auditory coding  
     7.2.1.5.7 ..... 7-9  
 critical information 8.2.1.11.1 ..... 8-45  
 upper-case letters ..... 8.2.1.11.1 ..... 8-45
- Visual cues (*see* Cues, visual)
- Visual display(s) (*see* Displays, visual)
- Visual display output (ADA)  
     7.6.2.3 ..... 7-106  
 adjustable image size 7.6.2.5 ..... 7-107  
 contrast and brightness  
     7.6.2.5 ..... 7-107  
 lettersize and symbols  
     7.6.2.5 ..... 7-107  
 projectors and cameras  
     7.6.2.6 ..... 7-107  
 readable from wheelchairs  
     7.6.2.3 ..... 7-106  
 special devices ..... 7.6.2.5 ..... 7-107
- Visual display terminals 9.6 ..... 9-52
- Visual envelope(s)  
 building ..... 14.1.4.5 ..... 14-10
- Visual feedback ..... 8.9.5.2 ..... 8-154
- Visual footprint ..... 14.1.4.5 ..... 14-7
- Visual output ..... 7.6.2.3 ..... 7-106
- Visual reference to reduce tremors  
     14.5.2.5 ..... 14-46
- Visual tiles, legends for 7.2.1.5.9 ..... 7-10
- Vocabulary (*see* Wording)
- Voice  
 control ..... 8.8.4.3 ..... 8-148  
     alternative devices 8.8.4.3.3 ..... 8-148  
     error correction ..... 8.8.4.3.1 ..... 8-148  
     vocabulary ..... 8.8.4.3.1 ..... 8-148  
 displays  
     acknowledgement . 8.5.9.2.6 ..... 8-124  
     alphabetic information  
       8.5.9.1.4 ..... 8-124  
     content ..... 8.5.9.2.3 ..... 8-124  
     formal words ..... 8.5.9.1.3 ..... 8-124  
     word choice ..... 8.5.9.1.1 ..... 8-124  
     word selection ..... 8.5.9.1 ..... 8-124  
     words to avoid ..... 8.5.9.1.2 ..... 8-124  
 input, appropriate use  
     8.8.4.1.2.c ..... 8-147  
 presentation ..... 8.5.9.2 ..... 8-124  
     alerting signals ..... 8.5.9.2.5 ..... 8-124  
     "average" talker .... 8.5.9.2.1 ..... 8-124  
     distinctive ..... 8.5.9.2.2 ..... 8-124  
     speech quality ..... 8.5.9.2.4 ..... 8-124
- Voice communication systems (*see also* Speech  
 reception equipment, Speech transmission  
 equipment, Speech intelligibility, and Telephone  
 systems) ..... 7.3.5 ..... 7-48
- Voice recognition, for identification and authentication  
     11.3.3 ..... 11-8
- Volume adjustment ..... 8.9.6.1.2.a ..... 8-155
- ## W
- Walkways ..... 9.3.1 ..... 9-8  
 floor surfaces ..... 9.3.3.3 ..... 9-11
- Warning(s)  
 displays ..... 7.2.1.5.1 ..... 7-9  
 in legend lights ..... 7.2.2.2.6 ..... 7-16  
 in user documentation  
     10.4.8 ..... 10-42 - 10-43  
     contents ..... 10.4.8.2 ..... 10-42  
     no procedural steps  
       10.4.8.6 ..... 10-43  
     precedence ..... 10.4.8.5 ..... 10-43  
     when to use ..... 10.4.8.1 ..... 10-42  
 visual devices ..... 7.2.1.5 ..... 7-9 - 7-10
- Warning labels (*see also* Labels)  
 describing hazard ..... 6.3.5.1.2 ..... 6-20  
     6.4.6.3 ..... 6-27  
 for connectors ..... 6.8.8.9 ..... 6-56  
 for hazards ..... 6.15.1.2.8 ..... 6-95  
     12.11.3 ..... 12-20  
 on ladders ..... 9.3.5.2.4 ..... 9-21  
 on modules ..... 6.10.5.16 ..... 6-79  
 on parts ..... 6.10.5.16 ..... 6-79  
 on ramps ..... 9.3.5.2.4 ..... 9-21  
 on stairs ..... 9.3.5.2.4 ..... 9-21  
 to prevent damage ..... 6.2.1.2 ..... 6-5  
 warning light location  
     7.2.2.1.7 ..... 7-14
- Warning message windows  
     8.3.10.2.11 ..... 8-76  
 accompanying audible signals  
     8.3.10.2.12 ..... 8-76

- Warning signal(s), verbal
- 7.3.3 ..... 7-46
  - alerting signal ..... 7.3.3.1 ..... 7-46
  - content ..... 7.3.3.6 ..... 7-47
  - critical warning signals
  - 7.3.3.7 ..... 7-47
  - delivery style ..... 7.3.3.4 ..... 7-47
  - intensity ..... 7.3.3.2 ..... 7-47
  - message priorities ..... 7.3.3.8 ..... 7-47
  - speech processing ..... 7.3.3.5 ..... 7-47
  - two-part signal ..... 7.3.3.1 ..... 7-46
  - type of voice ..... 7.3.3.3 ..... 7-47
- Warnings and signals, auditory (*see also* Warnings, verbal)
- 7.3.2 ..... 7-43
  - acoustical environment
  - 7.3.2.2.8 ..... 7-44
  - alerting capacity ..... 7.3.2.3.3 ..... 7-45
  - ambient noise level .... 7.3.2.3.1 ..... 7-45
  - audibility ..... 7.3.2.2.8 ..... 7-44
  - caution signals ..... 7.3.2.2.4 ..... 7-44
  - compatibility with clothing and equipment
  - 7.3.2.2.9 ..... 7-44
  - consistency ..... 7.3.2.3.11 ..... 7-46
  - effectiveness ..... 7.3.2.1.3 ..... 7-40
  - frequency range ..... 7.3.2.2.6 ..... 7-44
  - headset use ..... 7.3.2.3.6 ..... 7-45
  - 7.3.2.3.7 ..... 7-45
  - one-element signals 7.3.2.2.3 ..... 7-44
  - preceding alerting signal
  - 7.3.2.2.1, 7.3.2.2.2 .... 7-44
  - relation to visual displays
  - 7.3.2.2.5 ..... 7-44
  - signal characteristics 7.3.2.3 ..... 7-41 - 7-46
  - alerting capacity ... 7.3.2.3.3 ..... 7-45
  - audibility ..... 7.3.2.3.1 ..... 7-45
  - coding ..... 7.3.2.3.9 ..... 7-46
  - consistency ..... 7.3.2.3.11 ..... 7-46
  - dichotic presentation
  - 7.3.2.3.5 ..... 7-45
  - 7.3.2.3.14 ..... 7-46
  - distinct from routine signals
  - 7.3.2.3.10 ..... 7-46
  - maximum intensity
  - 7.3.2.3.2 ..... 7-45
  - multiple signals .... 7.3.2.3.8 ..... 7-46
  - noninterfering .... 7.3.2.3.13 ..... 7-46
  - onset and sound pressure level
  - 7.3.2.3.4 ..... 7-45
  - standard signals ..... 7.3.2.3.12 ..... 7-46
  - spurious signals ..... 7.3.2.2.7 ..... 7-45
  - two-element signals ... 7.3.2.2.1, 7.3.2.2.2 .... 7-45
  - when to use ..... 7.3.2.1.1 ..... 7-45
- Washer(s) ..... 6.7.3.5.8 ..... 6-45
- use ..... 6.7.3.1.7 ..... 6-41
- Way of exit ..... 9.3.4.4.1 ..... 9-15
- Weight (*see also* Heavy)
- labels ..... 6.3.5.1.3 ..... 6-20
  - 12.16.15 ..... 12-32
  - lifting capacity ..... 12.16.16 ..... 12-32
  - of equipment ..... 6.2.2.1 - 6.2.2.8 .... 6-6 - 6-7
  - 6.2.5.1.2 - 6.2.5.1.4 ..... 6-8
  - 6.2.8.3 ..... 6-12
  - 6.2.8.4 ..... 6-12
  - 6.2.10.1 ..... 6-13
  - reducing ..... 6.2.2.9 ..... 6-7
- Wheel locks ..... 9.3.3.2.2 ..... 9-11
- "When" (use of in user documentation)
- 10.2.4.5.1 ..... 10-13
- "Where" (use of in user documentation)
- 10.2.4.5.1 ..... 10-13
- White
- coding in CRT displays
  - 7.2.4.2.3 ..... 7-24
  - in controls ..... 7.4.1.4.5 ..... 7-58
  - reserved meaning in displays
  - 8.5.4.5.1.e ..... 8-106
  - use in CRT displays ... 7.2.4.2.4 ..... 7-24
- White space (*see also* Blank space)
- 10.3.2.3 ..... 10-18
  - document's structural hierarchy
  - 10.3.2.3.1 ..... 10-18
  - horizontal ..... 10.3.2.3.2 ..... 10-18
  - in columns ..... 10.3.2.7.2 ..... 10-20
  - in tables ..... 10.4.5.4.5 ..... 10-32
  - in this HFDG ..... 10.3.2.3.1 ..... 10-22
  - vertical ..... 10.3.2.3.1 ..... 10-22
- Widow protection ..... 8.4.2.3.6 ..... 8-91
- Width (*see also* Character, width)
- Width to height ratio (*see also* Stroke width)
- 6.3.5.3.4 ..... 6-21
- "Will"
- use of in this HFD Guide
  - 4.1.2 ..... 4-1
  - use of in user documentation
  - 10.2.4.5.2 ..... 10-14
- Window(s) ..... 8.6 ..... 8-125 - 8-130
- appearance ..... 8.3.2 ..... 8-55
  - application-level windows
  - 8.3.10 ..... 8-72
  - application menu bar . 8.3.10.1.1.c ..... 8-72
  - application title bar .... 8.3.10.1.1.c ..... 8-108
  - border ..... 8.3.2.3.1 ..... 8-56
  - color (*see* Color, in windows)
  - components ..... 8.3.2 ..... 8-55
  - border ..... 8.3.2.3 ..... 8-56
  - icons (*see also* Icons)
  - 8.1.15 ..... 8-36
  - menu bar ..... 8.3.2.4 ..... 8-56
  - primary ..... 8.3.2.1.1 ..... 8-55
  - secondary ..... 8.3.2.1.2 ..... 8-56
  - title bar ..... 8.3.2.2 ..... 8-56
  - consistent organization
  - 8.3.10.1.10 ..... 8-74
  - continuous text ..... 8.5.6.3.2 ..... 8-116
  - control(s) ..... 8.3.3 ..... 8-57
  - 8.3.10.1.11 ..... 8-74
  - design considerations . 8.2.1.8 ..... 8-44
  - general ..... 8.3.1 ..... 8-55
  - confirmed destruction
  - 8.1.1.27 ..... 8-4
  - error detection ..... 8.1.1.26 ..... 8-4
  - ignoring user actions
  - 8.1.1.25 ..... 8-4
  - immediate feedback
  - 8.1.1.22 ..... 8-3
  - object-action paradigm
  - 8.1.1.20 ..... 8-3
  - prompts ..... 8.1.1.24 ..... 8-4
  - user control ..... 8.1.1.21 ..... 8-3
  - visual cues ..... 8.1.1.23 ..... 8-4
  - management ..... 8.3.11 ..... 8-79

- Window(s) (continued)
- menu bar (*see* Menu bar(s))
  - menus (*see also* Menu(s))
    - 8.3.7 ..... 8-67
  - operations ..... 8.3.5 ..... 8-61
  - placement ..... 8.3.2.1.3.b, 8.3.2.1.4 .. 8-56
  - primary ..... 8.3.2.1.1 ..... 8-55
    - message area ..... 8.3.10.1.9 ..... 8-74
  - restoring from icon .... 8.1.15.1.10 ..... 8-37
  - secondary ..... 8.3.2.1.2 ..... 8-56
    - association with primary window
      - 8.3.2.1.3.a ..... 8-56
      - closing ..... 8.3.2.1.3.c ..... 8-56
      - constraints ..... 8.3.2.1.3 ..... 8-56
      - mode ..... 8.3.11.5 ..... 8-79
      - removal ..... 8.3.2.1.3.d ..... 8-56
      - superimposition .... 8.3.2.1.3.b ..... 8-56
  - states ..... 8.3.4 ..... 8-59
  - system-level windows
    - 8.3.9 ..... 8-69
    - system menu bar ..... 8.3.9.3.2 ..... 8-107
    - system title bar ..... 8.3.9.2.2.a ..... 8-70
    - 8.3.9.2.3 ..... 8-71
  - task-specific windows
    - 8.3.12 ..... 8-80
    - data entry (*see* Windows, data entry)
    - help (*see* Windows, help)
    - maps (*see* Windows, map)
    - sending and receiving messages (*see* Windows, sending and receiving messages)
    - text (*see* Windows, text)
    - text (*see* Windows, text; Text in windows)
    - title bar ..... 8.3.2.2.1 ..... 8-56
    - 8.3.9.2.2.a ..... 8-70
- Window design
- audible coding ..... 8.2.1.11.3 ..... 8-46
  - exclusive options ..... 8.2.1.8.2 ..... 8-44
  - flash coding ..... 8.2.1.11.2 ..... 8-46
  - location by importance
    - 8.2.1.10.1 ..... 8-45
  - match to task ..... 8.2.1.9.1 ..... 8-45
    - match to users "natural" patterns
      - 8.2.1.9.2 ..... 8-45
  - memory load ..... 8.2.1.8.1 ..... 8-44
  - menus ..... 8.2.1.8.2 ..... 8-44
  - 8.2.1.8.5 ..... 8-44 - 8-45
  - minimal user effort .... 8.2.1.9.3 ..... 8-45
  - nonexclusive options . 8.2.1.8.3 ..... 8-44
  - pop-up menus ..... 8.2.1.8.5 ..... 8-45
  - task-oriented information
    - 8.2.1.10.2 ..... 8-45
  - user control ..... 8.2.1.12.1 ..... 8-46
  - visual coding ..... 8.2.1.11.1 ..... 8-45
- Window management ..... 8.3.11 ..... 8-79
- initial contents and organization
    - 8.3.11.1 ..... 8-79
  - initial placement ..... 8.3.11.3 ..... 8-79
  - initial size ..... 8.3.11.2 ..... 8-79
  - mode ..... 8.3.11.5 ..... 8-79
  - resizing ..... 8.3.11.4 ..... 8-79
- Window menu
- control in title bar ..... 8.3.2.2.1 ..... 8-56
- Window mode ..... 8.3.4.4 ..... 8-61
- mode ..... 8.3.4.4.1, 8.3.4.4.2 ..... 8-61
  - modeless ..... 8.3.4.4.1, 8.3.4.4.2 ..... 8-61
  - primary windows ..... 8.3.4.4.1 ..... 8-61
  - secondary windows .... 8.3.4.4.2 ..... 8-61
  - 8.3.11.5 ..... 8-79
- Window operations ..... 8.3.5 ..... 8-61
- "Close" (*see also* "Close")
    - 8.3.5.14 ..... 8-63
  - consistency within application
    - 8.3.5 ..... 8-61
  - consistency within system
    - 8.3.5 ..... 8-61
  - copying objects ..... 8.3.5.17 ..... 8-64
  - "Iconize" (*see also* "Iconize")
    - 8.3.5.8 ..... 8-63
  - iconizing a window using a pointing device
    - 8.3.5.9 ..... 8-63
  - iconizing a window using the keyboard
    - 8.3.5.10 ..... 8-63
  - incoming messages .... 8.3.12.5.10 ..... 8-85
  - "Maximize" ..... 8.3.5.13 ..... 8-63
  - message windows
    - allowed operations
      - 8.3.10.2.1 ..... 8-74
    - disallowed operations
      - 8.3.10.2.2 ..... 8-74
  - "Move" (*see also* "Move")
    - 8.3.5.2 ..... 8-62
  - moving a window using a pointing device
    - 8.3.5.3 ..... 8-62
  - moving a window using the keyboard
    - 8.3.5.4 ..... 8-62
  - moving objects ..... 8.3.5.17 ..... 8-64
  - "Next window" (*see also* "Next window")
    - 8.3.5.15 ..... 8-64
  - opening an icon using a pointing device
    - 8.3.5.11 ..... 8-63
  - opening a window using the keyboard
    - 8.3.5.12 ..... 8-63
  - "Previous window" (*see also* "Previous window")
    - 8.3.5.16 ..... 8-64
  - "Resize" (*see also* "Resize")
    - 8.3.5.5 ..... 8-62
  - resizing a window using a pointing device
    - 8.3.5.6 ..... 8-62
  - resizing a window using the keyboard
    - 8.3.5.7 ..... 8-63
  - "Restore" (*see also* "Restore")
    - 8.3.5.1 ..... 8-62
- Window states ..... 8.3.4 ..... 8-59
- active ..... 8.3.4.2.1 ..... 8-59
  - changing states
    - closing a primary window
      - 8.3.4.1.3 ..... 8-59
    - closing a secondary window
      - 8.3.4.1.4 ..... 8-59
    - making a window active
      - 8.3.4.2.2 ..... 8-60
    - making a window inactive
      - 8.3.4.2.3 ..... 8-60
    - opening an iconized window
      - 8.3.4.1.6 ..... 8-59
  - closed ..... 8.3.4.1.2 ..... 8-59
  - frozen ..... 8.2.1.12.3 ..... 8-46
  - iconized ..... 8.3.4.1.5 ..... 8-59
  - 8.2.1.12.3 ..... 8-46
  - inactive ..... 8.3.4.2.3 ..... 8-59
  - 8.2.1.12.3 ..... 8-46
  - open ..... 8.3.4.1.1 ..... 8-59

Windows, application-level			
components	8.3.10	8-72	
command entry area	8.3.10.1.1	8-72	
	8.3.10.1.1.e	8-73	
menu bar	8.3.10.1.1.c	8-72	
	8.3.10.1.3	8-73	
menu control	8.3.10.1.1.b	8-72	
message area	8.3.10.1.1.f	8-73	
title bar	8.3.10.1.1.a	8-72	
working area	8.3.10.1.1.d	8-73	
working area	8.3.12.1.2	8-80	
	8.3.12.2.1	8-81	
	8.3.12.2.4	8-81	
Windows, data entry	8.3.12.2	8-81	
controls	8.3.12.2.5	8-81	
correspondence with hard copy forms			
	8.3.12.2.2	8-81	
editing data	8.3.12.2.10	8-82	
elements	8.3.12.2.1	8-81	
entering data	8.3.12.2.11	8-82	
field labels	8.3.12.2.8	8-82	
fields	8.3.12.2.7	8-82	
help	8.3.12.2.6	8-82	
multipage windows	8.3.12.2.3	8-81	
navigation	8.3.12.2.9	8-82	
organization	8.3.12.2.2	8-81	
push buttons	8.3.12.2.5	8-81	
saving data	8.3.12.2.11	8-82	
Windows, help	8.3.12.1	8-80	
elements	8.3.12.1.2	8-80	
information	8.3.12.1.4	8-80	
movable and resizable			
	8.6.1.1.6	8-126	
removal	8.3.12.1.6	8-81	
size and placement	8.3.12.1.3	8-80	
wording of information			
	8.3.12.1.5	8-81	
Windows, map ( <i>see also</i> Map displays)			
color coding	8.3.12.4.6	8-83	
color coding key	8.3.12.4.4	8-83	
crowded, cluttered maps			
	8.3.12.4.10	8-84	
editing labels and overlays			
	8.6.12.4.8	8-84	
elements	8.3.12.4.1	8-83	
label legibility	8.3.12.4.4	8-83	
label position	8.3.12.4.3	8-83	
orientation	8.3.12.4.2	8-83	
reading distance and bearing			
	8.3.12.4.9	8-84	
symbols	8.3.12.4.6	8-83	
user control	8.3.12.4.7	8-83	
	8.3.12.4.11	8-84	
Windows, message	8.3.10.2	8-74	
allowed operations	8.3.10.2.1	8-74	
confirmation	8.3.10.2.10	8-76	
contents	8.3.10.2.3	8-75	
disallowed operations	8.3.10.2.2	8-74	
error	8.3.10.2.7	8-76	
information	8.3.10.2.8	8-76	
message wording	8.3.10.2.4	8-75	
push buttons	8.3.10.2.3	8-75	
request	8.3.10.2.6	8-75	
size and location	8.3.10.2.5	8-75	
symbols	8.3.10.2.3	8-75	
title	8.3.10.2.3	8-75	
warning	8.3.10.2.11	8-76	
"working"	8.3.10.2.13	8-76	
Windows, sending and receiving messages			
	8.3.12.5	8-84	
applicable criteria and guidelines			
	8.3.12.5.1	8-84	
delayed or unsuccessful transmission			
	8.3.12.5.6	8-84	
distribution lists	8.3.12.5.4	8-84	
fields and headers	8.3.12.5.2	8-84	
help on fields	8.3.12.5.3	8-84	
log of message transmission			
	8.3.12.5.7	8-85	
message transmission	8.3.12.5.5	8-84	
operations	8.3.12.5.10	8-85	
queuing and logging incoming messages			
	8.3.12.5.9	8-85	
standard message formats			
	8.3.12.5.2	8-84	
user specified feedback			
	8.3.12.5.7	8-85	
Windows, system-level	8.3.9	8-69	
navigation	8.3.9.4.3.c	8-72	
screen saver	8.3.9.4.3.a	8-72	
"Suspend"	8.3.9.4.3.b	8-72	
system access	8.3.9.1.1	8-69	
system log on and log off			
	8.3.9.1	8-69	
system menu ( <i>see also</i> Menu(s), system)			
	8.3.9.3	8-71	
	8.3.9.4.1	8-71	
system menu bar	8.3.9.3.2	8-71	
system support	8.3.9.4	8-71	
system title bar	8.3.9.2.2.a	8-70	
	8.3.9.2.3	8-71	
system window	8.3.9.2	8-70	
appearance	8.3.9.2.1	8-70	
behavior	8.3.9.2.3	8-71	
components	8.3.9.2.2	8-70	
user-specified settings			
	8.3.9.4.4	8-72	
utilities menu	8.3.9.4.2	8-72	
Windows, text ( <i>see also</i> Text in windows)			
	8.3.8	8-68	
	8.3.12.3	8-12	
incoming messages	8.3.12.5.10	8-85	
insert mode	8.3.8.6	8-69	
manipulating text	8.3.8.7	8-69	
operations	8.3.12.3.3	8-82	
pointer and text cursor			
	8.3.8.4, 8.3.8.5	8-69	
scroll bars	8.3.12.3.2	8-82	
search and replace capability			
	8.3.12.3.5	8-83	
text cursor	8.3.8.1		
	- 8.3.8.4	8-68 - 8-69	
text entry	8.3.8.8	8-69	
text manipulation	8.3.12.3.4	8-82	
width	8.3.12.3.1	8-82	
Wire connections	6.8.5.2	6-52	
leads			
spacing of	6.8.5.2.2	6-53	
Wire harness	6.9.1.1.7	6-58	
	6.9.1.3.7	6-61	
Wire, identification of	6.8.8.3	6-56	
Wire length, extra	6.8.5.2.4	6-53	

- Wire wrapping (*see* Pig tailing)
- Wiring  
  location of ..... 6.10.3.3.1 ..... 6-75  
  routing ..... 6.8.5.1.5 ..... 6-51  
   12.4.1.17 ..... 12-9
- Wiring diagrams (in a user document)  
  10.4.4.5.3 ..... 10-37
- Word(s) ..... 10.2.4 ..... 10-12 - 10-18  
  abstract ..... 10.2.4.3.1 ..... 10-13  
  ambiguous ..... 10.2.4.3.2 ..... 10-13  
  concrete ..... 10.2.4.3.1 ..... 10-13  
  consistency ..... 10.2.4.1 ..... 10-12  
  definitions (in user documentation)  
   10.2.4.7 ..... 10-14  
  high-frequency ..... 10.2.4.2.1 ..... 10-12  
  hyphenation ..... 10.2.3.10.4 ..... 10-11  
  indefinite ..... 10.2.4.3.3 ..... 10-13  
  pronouns ..... 10.2.4.6.1 ..... 10-14  
  short ..... 10.2.4.2.2 ..... 10-12  
  simple ..... 10.2.4.2.3 ..... 10-13  
  spacing between ..... 7.5.3.7 ..... 7-100  
   8.2.3.4 ..... 8-48  
  standard verbs ..... 10.2.4.4.1 ..... 10-13  
   ..... Appendix D  
  terminology ..... 10.2.4.1.1 ..... 10-12  
  verbs ..... 10.2.4.4.1 ..... 10-13
- Wording (*see also* Language)  
  clear, simple ..... 10.2.3.1.1 ..... 10-8  
  consistency ..... 6.3.5.4.1 ..... 6-22  
   8.5.2.1.1 ..... 8-103  
  direct, complete ..... 10.2.3.1.3 ..... 10-8  
  help information ..... 8.3.12.1.5 ..... 8-81  
   8.6.1.4.2 ..... 8-128  
  negative ..... 10.2.3.8.2 ..... 10-10  
  noneditable text in windows  
   8.3.10.4.12 ..... 8-78  
  nonexistent ..... 10.2.3.1.3 ..... 10-8  
  of commands in command language  
   8.1.13.7 - 8.1.13.9 ..... 8-29  
   8.1.13.12 ..... 8-30  
  of control labels ..... 7.5.5.1 - 7.5.5.3 ..... 7-101  
  of control options ..... 8.1.6.6 ..... 8-14  
  of displayed data ..... 8.5.1.10 ..... 8-102  
  of labels ..... 6.3.5.4 ..... 6-22  
  of messages ..... 8.3.10.2.4 ..... 8-75  
  of on-line help ..... 8.6.1.4.2 ..... 8-128  
  of options in menus ... 8.1.11.1.3 ..... 8-25  
   8.1.11.8.1, 8.1.11.8.2 . 8-25  
   8.3.7.1.2 ..... 8-65  
  of routine messages ... 8.1.3.6.3 ..... 8-9  
  of sentences ..... 10.2.3.1 ..... 10-8  
  of transactions ..... 8.1.1.10 ..... 8-2  
  of voice displays ..... 8.5.9.1 ..... 8-124  
  positive ..... 10.2.3.8.1 ..... 10-10  
  spacing of ..... 6.3.5.3.6 ..... 6-21  
  technical terms ..... 10.2.3.1.2 ..... 10-8
- Word order  
  sentence  
   chronological ..... 10.2.3.5.2 ..... 10-9  
   importance ..... 10.2.3.5.3 ..... 10-9  
   normal ..... 10.2.3.5.1 ..... 10-9
- Work area  
  aisles ..... 9.2.1.12 ..... 9-4  
  entrances ..... 9.3.4.1.1 ..... 9-13  
  exits ..... 9.3.4.1.1 ..... 9-13  
  storage ..... 9.2.1.12 ..... 9-4
- Workbench(es)  
  dimensions ..... 9.4.3.1 ..... 9-38  
  uncushioned ..... 9.4.4.8 ..... 9-42
- Working area (*see* Windows, application-level, working area)
- "Working" message windows  
  progressive ..... 8.3.10.2.13 ..... 8-76  
  8.3.10.2.14 ..... 8-76
- Working position(s)  
  common ..... 9.4 ..... 9-31 - 9-43  
   14.1.4.2 ..... 14-9  
  designing reference points from  
   14.1.4.3 ..... 14-9  
  mobile ..... 14.1.4.2 ..... 14-9  
  static dimensions for .. 9.4.1 ..... 9-31
- Workload  
  control automation .... 5.2.16 ..... 5-7  
  control selection ..... 7.4.1.1.1 ..... 7-50  
  decision aids ..... 5.2.21 ..... 5-9
- Workplace(s)  
  design ..... 9 ..... 9-1  
  hazard ..... 12.12 ..... 12-21 - 12-23  
  illumination ..... 13.4.2.2 ..... 13-8  
  maintenance ..... 13.1.1 ..... 13-1  
  noise levels ..... 12.12.1 ..... 12-21  
   13.5.2.3 ..... 13-16  
  physical anthropometry  
   9.1.2 ..... 9-1  
  seated ..... 9.4.4 ..... 9-39  
   advantages ..... 9.4.4 ..... 9-39  
  seats ..... 9.4.4.1 ..... 9-40  
  standing ..... 9.4.3 ..... 9-38  
   advantages ..... 9.4.3 ..... 9-38  
   dimensions ..... 9.4.3.1 ..... 9-38
- Work population, foreign  
  14.2.1 ..... 14-15
- Work space(s) (*see also* Workplace)  
  accessibility ..... 9.1.3 ..... 9-2  
  acoustical design for .. 13.5.2.1 ..... 13-16  
  adequate ..... 4.2.4.a ..... 4-4  
  arrangement of ..... 4.2.4.a ..... 4-4  
  characteristics ..... 4.2.4 ..... 4-4  
  clean ..... 12.2.1.5 ..... 12-2  
  design compatibility .. 4.2.1.d ..... 4-3  
  electrical equipment ... 6.2.1.1 ..... 6-5  
   9.2.1.4 ..... 9-4  
   12.4.1.18 ..... 12-9  
  mobile  
   dimensions ..... 9.4.2.2 ..... 9-36  
   limitations ..... 9.4.2.1 ..... 9-36  
  mobility in ..... 9.4.2 ..... 9-36  
  obstruction-free ..... 12.2.1.5 ..... 12-2  
  personnel accommodations  
   4.2.4.b ..... 4-4
- Writing level in user documentation (*see also* Readability) ..... 10.2.3.2.1 ..... 10-8
- ## Y
- Yellow  
  coding in CRT displays  
   7.2.4.2.3 ..... 7-23  
   8.2.4.1.23 ..... 8-53  
  comparisons ..... 7.2.6.5 ..... 7-32  
  in controls ..... 7.4.1.4.5 ..... 7-61  
  in displays ..... 8.2.4.1.21 ..... 8-53  
  in scales ..... 7.2.3.1.16 ..... 7-21

- Yellow (continued)  
 reserved meaning in displays  
     8.5.4.5.1.c ..... 8-106  
 use in CRT displays ... 7.2.4.2.4 ..... 7-24  
 "Yes"  
 push button  
   in confirmation message windows  
     8.3.10.2.10 ..... 8-76  
   in warning message windows  
     8.3.10.2.11 ..... 8-76

## Z

- Zero(s)  
 and direction of pointer movement  
     7.2.3.2.4 ..... 7-21  
 in numeric scales ..... 8.5.5.4.12 ..... 8-112  
 leading and trailing  
   in a user document  
     10.2.4.10.4 ..... 10-17  
   in fields in forms .. 8.4.3.7.2 ..... 8-96  
 in tables in displays  
     8.4.5.3 ..... 8-98  
 Zoom(ing) ..... 8.5.6.4 ..... 8-116  
 graphic data display ... 8.4.6.2.12 ..... 8-100  
 in map displays ..... 8.5.8.1.3 ..... 8-118  
     8.5.8.3.4  
     - 8.5.8.3.9 ..... 8-120 - 8-121  
 scale indication ..... 8.5.6.4.3 ..... 8-116  
 scale integration ..... 8.5.6.4.4 ..... 8-116  
 when to use ..... 8.5.6.4.2 ..... 8-116